

Ø2.0/Ø3.0

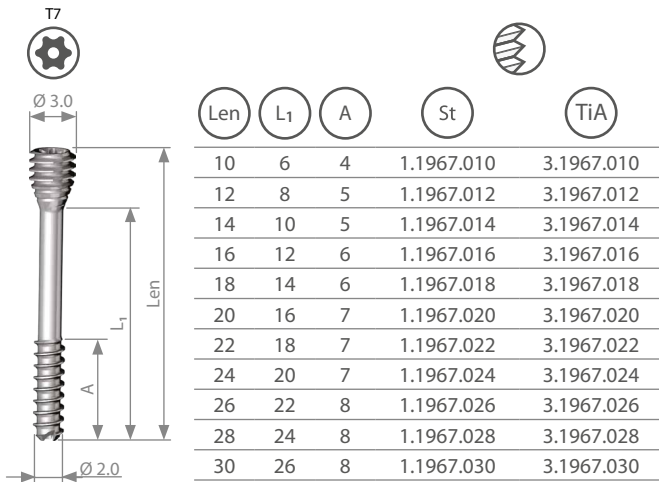

Ø2.5/Ø3.2

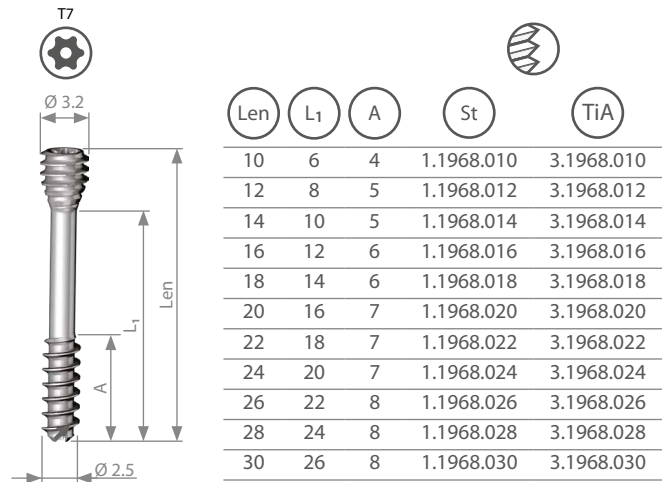



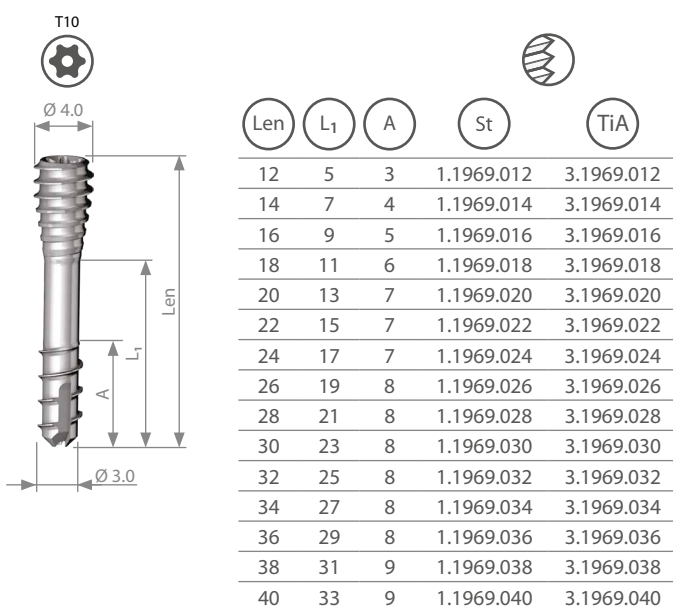



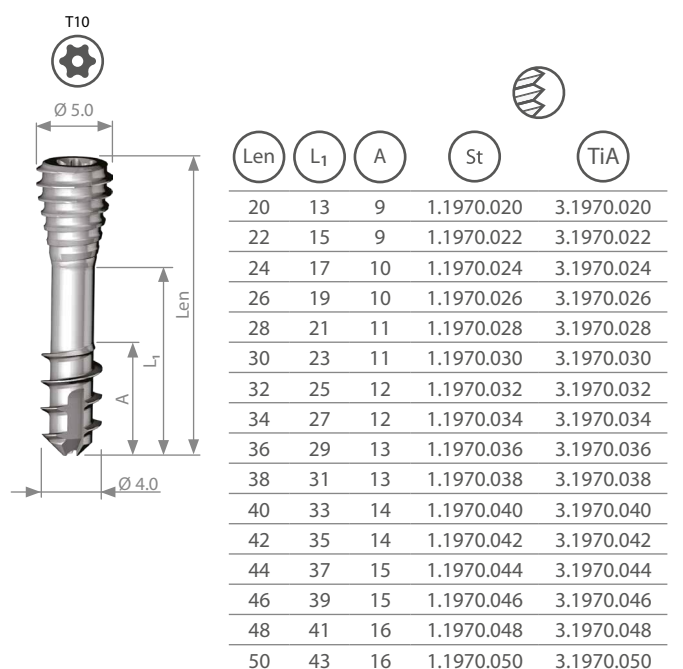

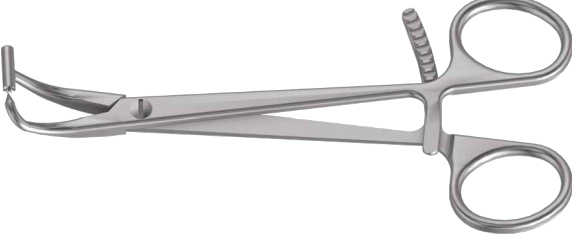





Ø3.0/Ø4.0



Ø4.0/Ø5.0



|   | Name<br>Nazwa   | Catalogue no.<br>Nr katalogowy | Pcs<br>Szt. |
|---|---|--------------------------------|-------------|
|    | Handle ratchet device<br>Rękojeść ze sprzęgłem  | 40.6654.000                    | 1           |
|    | Compression forceps<br>Szczypce kompresyjne   | 40.8122.000                    | 1           |
|    | Wire guide<br>Prowadnica drutu  | 40.8123.000                    | 1           |
|    | Cannulated drill 1.6x150<br>Wiertło kaniulowane 1,6x150   | 40.8124.150                    | 2           |
|    | Cannulated drill 2.6x150<br>Wiertło kaniulowane 2,6x150   | 40.8125.150                    | 2           |
|    | Depth measure<br>Wzorec głębokości  | 40.8126.000                    | 1           |
|  | Forceps<br>Pinceta  | 40.8127.000                    | 1           |
|  | Screwdriver tip T10<br>Grot T10   | 40.8129.000                    | 1           |
|  | Screwdriver tip T7<br>Grot T7   | 40.8130.000                    | 1           |
|  | Guide<br>Tuleja   | 40.8131.000                    | 2           |
|  | Guide rod 0.8/150<br>Drut prowadzący 0,8x150  | 40.8132.150                    | 4           |
|  | Guide rod 1.0/150<br>Drut prowadzący 1,0x150  | 40.8133.150                    | 4           |
|  | Palette for instruments and implants<br>Paleta na narzędzia i implanty                                    | 40.8121.000                    | 1           |
|  | Container with solid bottom 1/2<br>306x272x85mm<br>Kontener z litym dnem 1/2 306x272x85mm                 | 12.0751.100                    | 1           |
|  | Perforated aluminum cover 1/2<br>306x272x15mm Gray<br>Pokrywa aluminiowa perfor.1/2<br>306x272x15mm Szara | 12.0751.200                    | 1           |