

ChM[®]

ChM Micro Plates
ChMP system

3.0 ChM Locked Plating
ChLP system

SYSTEMY IMPLANTÓW - DŁOŃ
IMPLANT SYSTEMS - HAND
СИСТЕМЫ ИМПЛАНТАТОВ - ЛАДОНЬ

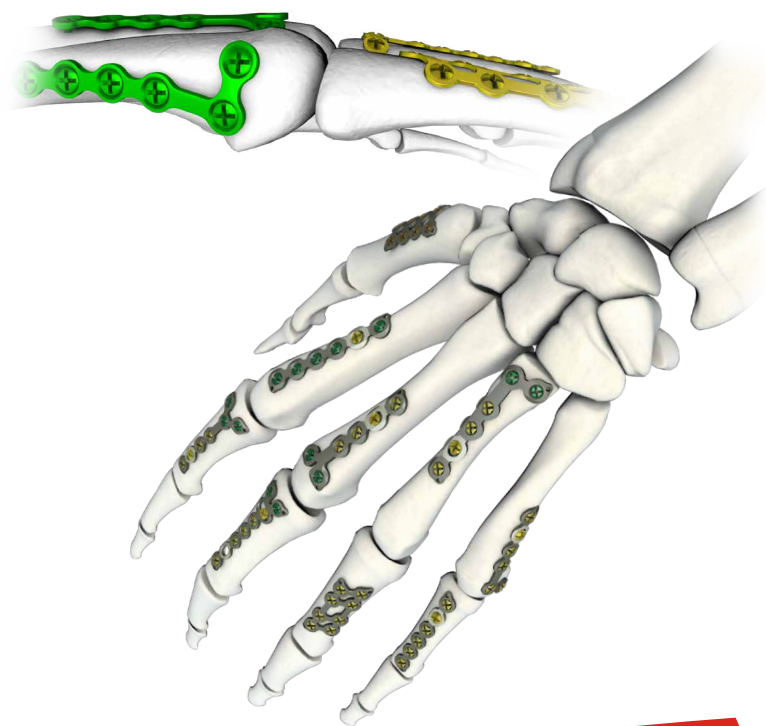

OBJAŚNIENIA SYMBOLI / SYMBOLS DESCRIPTION / ОПИСАНИЕ СИМВОЛОВ

	Tytan / Titanium / Титан
	Stop tytanu / Titanium alloy / Сплав титана
	Kobalt / Cobalt / Кобальт
	Aluminium / Aluminum / Алюминий
	Lewy / Left / Левый
	Prawy / Right / Правый
	Dostępne w wersji lewy-prawy / Available versions: left-right / Доступные варианты: левый-правый
	Długość / Length / Длина
	Średnica [mm] / Diameter [mm] / Диаметр [мм]

	Gniazdo torx / Torx drive / Шлиц торкс
	Gniazdo sześciokątne / Hexagonal drive / Шлиц шестигранный
	Gniazdo typu X / X-type drive / Шлиц X-типа
	Gniazdo kwadratowe / Square drive / Шлиц квадратный
	Blokowany / Locking / Блокирующий
	Skala 1:1 / Scale 1:1 / Масштаб 1:1
	Skala 1:2 / Scale 1:2 / Масштаб 1:2
	Zmienny kątowo / Variable angle / Переменный угол
	Patrz technika operacyjna / Refer to surgical technique / Смотри операционную технику

SYSTEM IMPLANTÓW - DŁOŃ	5
IMPLANTS SYSTEM - HAND	
СИСТЕМА ИМПЛАНТАТОВ - ЛАДОНЬ	
PALICZKI ŚRODKOWE, BLIŻSZE 1,5 ChMP	7
INTERMEDIATE, PROXIMAL PHALANGES 1.5 ChMP	
СРЕДНИЕ ФАЛАНГИ, ПРОКСИМАЛЬНЫЕ 1,5 ChMP	
PALICZKI BLIŻSZE, ŚRÓDRĘCZE 2,0 ChMP	9
PROXIMAL PHALANGES, METACARPALS 2.0 ChMP	
ПРОКСИМАЛЬНЫЕ ФАЛАНГИ, ПЯСТНЫЕ КОСТИ 2,0 ChMP	
WKRETY 1,5 ChMP	10
SCREWS 1.5 ChMP	
ВИНТЫ 1,5 ChMP	
WKRETY 2,0 ChMP	11
SCREWS 2.0 ChMP	
ВИНТЫ 2,0 ChMP	
INNE NARZĘDZIA	22
OTHER INSTRUMENTS	
ДРУГИЕ ИНСТРУМЕНТЫ	
SYSTEM IMPLANTÓW BLOKOWANYCH - DŁOŃ	23
LOCKING IMPLANTS SYSTEM - HAND	
СИСТЕМА БЛОКИРУЮЩИХ ИМПЛАНТАТОВ - ЛАДОНЬ	
WKRETY 3,0 ChLP	28
SCREWS 3.0 ChLP	
ВИНТЫ 3,0 ChLP	
STATYW NA WKRETY 3,0ChLP	30
STAND FOR 3.0ChLP SCREWS	
ПОДСТАВКА ДЛЯ ВИНТОВ 3,0ChLP	
STATYW NA PŁYTKI 3,0ChLP	31
STAND FOR PLATES 3.0ChLP	
ПОДСТАВКА ДЛЯ ПЛАСТИН 3,0ChLP	
PRZYKŁAD KOMPLETACJI	34
EXAMPLE OF CONFIGURATION	
ПРИМЕР КОМПЛЕКТАЦИИ	
ZESTAW 3,0ChLP 15.0203.001	36
Set for 3.0ChLP 15.0203.001	
Инструменты для 3,0ChLP 15.0203.001	

SYSTEM IMPLANTÓW NIEBLOKOWANYCH - DŁOŃ
NON-LOCKING IMPLANTS SYSTEM - HAND
СИСТЕМА НЕБЛОКИРУЮЩИХ ИМПЛАНТАТОВ - ЛАДОНЬ

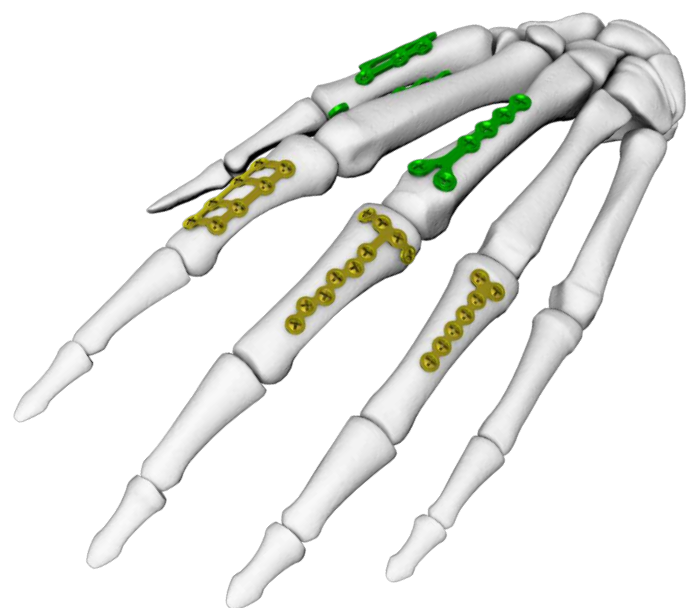

PALICZKI ŚRODKOWE, BLIŻSZE
INTERMEDIATE, PROXIMAL PHALANGES
СРЕДНИЕ ФАЛАНГИ, ПРОКСИМАЛЬНЫЕ



grubość thickness толщина	0,6	3.3472.006	3.3472.016
otwory/holes/отверстия		6	16
wymiar/size/измерение		23	63

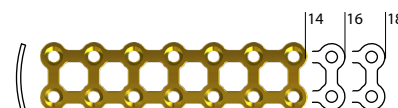
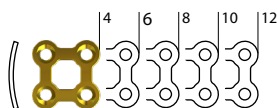

grubość thickness толщина	0,6	3.3454.904	3.3454.906	3.3454.908	3.3454.910	3.3454.912	3.3454.914	3.3454.916	3.3454.918
otwory/holes/отверстия		4	6	8	10	12	14	16	18
wymiar/size/измерение		9x9	9x15	9x20	9x25	9x31	9x37	9x42	9x48

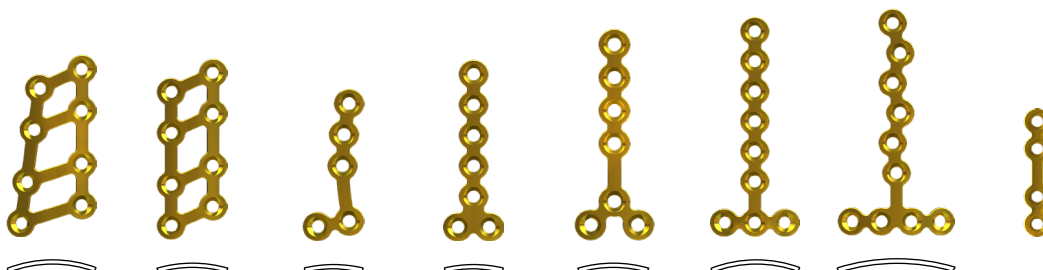

grubość thickness толщина	0,6	L	3.3462.908	3.3460.908	3.4719.905	3.3406.907	3.3416.907	3.4628.909	3.4723.910	3.3342.004
		R	3.3464.908	3.3458.908	3.4720.905					
otwory/holes/отверстия			8	8	5	7	7	9	10	4
wymiar/size/измерение			12x24	9x24	8x20	8x24	9x28	12x29	15x30	17

PALICZKI ŚRODKOWE, BLIŻSZE
INTERMEDIATE, PROXIMAL PHALANGES
СРЕДНИЕ ФАЛАНГИ, ПРОКСИМАЛЬНЫЕ



Ti 1:1

grubość thickness толщина	0,6	3.3346.002	3.3348.002	3.3340.004	3.3344.004
otwory/holes/отверстия		2	2	4	4
wymiar/size/измерение		11	15	17	20

Ti 1:1

grubość thickness толщина	0,6	L	3.4723.912	3.3462.916
		R		3.3464.916
otwory/holes/отверстия			12	16
wymiar/size/измерение			16x38	13x44

PALICZKI BLIŻSZE, ŚRÓDREČZE
PROXIMAL PHALANGES, METACARPALS
ПРОКСИМАЛЬНЫЕ ФАЛАНГИ, ПЯСТНЫЕ КОСТИ

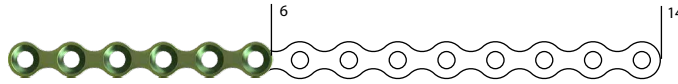

grubość/thickness толщина	1,0	3.3086.506	3.3086.514
otwory/holes/отверстия		6	14
wymiar/size/измерение		35	89

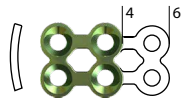

grubość/thickness толщина	1,0	3.4472.904	3.4472.906
otwory/holes/отверстия		4	6
wymiar/size/измерение		9x11	9x17

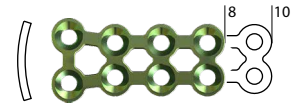

grubość/thickness толщина	1,0	3.4494.908	3.4494.910
otwory/holes/отверстия		8	10
wymiar/size/измерение		11x23	11x29

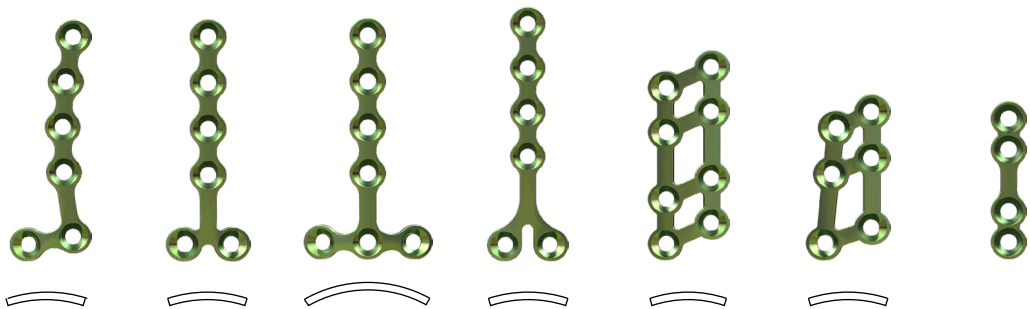

grubość thickness толщина	1,0	L	3.4491.906	3.3733.906	3.3745.907	3.4455.906	3.3794.908	3.3798.906	3.3085.121
		R	3.4492.906				3.3796.908	3.3800.906	
otwory/holes/отверстия			6	6	7	6	8	6	4
wymiar/size/измерение			10x32	11x32	16x32	11x35	11x28	11x22	21

Ø1,5

Len	TiA	
3	3.6650.503	
4	3.6650.504	
5	3.6650.505	
6	3.6650.506	
7	3.6650.507	
8	3.6650.508	
9	3.6650.509	
10	3.6650.510	
11	3.6650.511	
12	3.6650.512	
13	3.6650.513	
14	3.6650.514	
15	3.6650.515	
16	3.6650.516	
Szt. Pcs Шт.		5



Ø1,8 AWARYJNY, EMERGENCY АВАРИЙНЫЕ

Len	TiA	
5	3.6651.505	
7	3.6651.507	
9	3.6651.509	
11	3.6651.511	
13	3.6651.513	
15	3.6651.515	
17	3.6651.517	
20	3.6651.520	
Szt. Pcs Шт.		5

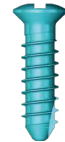

Ø1,8 KOMPRESYJNY, COMPRES- SION, КОМПРЕССИОННЫЙ

Len	TiA	
10	3.6658.510	
12	3.6658.512	
14	3.6658.514	
16	3.6658.516	
18	3.6658.518	
Szt. Pcs Шт.		5



Opcjonalne narzędzia do wkrętów kompresyjnych – Wiertła stopniowe 1,2-10÷18[40.8424.010÷018];
Optional instruments for compression screws – Gradual drills 1.2-10÷18 [40.8424.010÷018];
Инструменты для компрессионных винтов – опционально - Сверло фазное 1,2-10÷18 [40.8424.010÷018];

Ø2,0

Len	TiA	
4	3.6660.504	
5	3.6660.505	
6	3.6660.506	
7	3.6660.507	
8	3.6660.508	
9	3.6660.509	
10	3.6660.510	
11	3.6660.511	
12	3.6660.512	
13	3.6660.513	
14	3.6660.514	
15	3.6660.515	
16	3.6660.516	
17	3.6660.517	
18	3.6660.518	
19	3.6660.519	

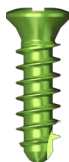

**Ø2,3
 AWARYJNY, EMERGENCY,
 АВАРИЙНЫ**

Len	TiA	
4	3.6661.504	
5	3.6661.505	
6	3.6661.506	
7	3.6661.507	
8	3.6661.508	
9	3.6661.509	
10	3.6661.510	
12	3.6661.512	
14	3.6661.514	
16	3.6661.516	
18	3.6661.518	



Szt.
Pcs
Шт.



5

Szt.
Pcs
Шт.



5

Statyw na wkręty ChMP 4x2 1/2H
 Stand for screws ChMP 4x2 1/2H
 Подставка для винтов ChMP 4x2 1/2H

14.0301.501

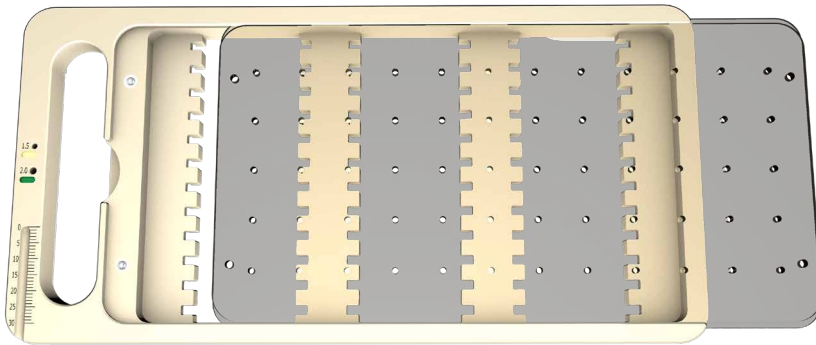

Szt.
Pcs
Шт.



36

Statyw nie zawiera implantów
 Tray does not include implants
 Подставка без имплантатов

Max długość wkrętów 20mm
 Max screw length 20mm
 Максимальная длина винта 20мм

Statyw na płytki 1,5ChMP 4x2 1/4H
 Stand for 1.5ChMP plates 4x2 1/4H
 Подставка для пластин 1,5ChMP 4x2 1/4H

14.0303.401



Statyw nie zawiera implantów
 Tray does not include implants
 Подставка без имплантатов

	3.3472.016
	3.3342.004
	3.3472.006
	3.4719.905
	3.4720.905
	3.3406.907
	3.3416.907
	3.4628.909
	3.4723.910

Statyw na płytki 1,5ChMP 4x2 1/4H
 Stand for 1.5ChMP plates 4x2 1/4H
 Подставка для пластин 1,5ChMP 4x2 1/4H

14.0303.402



Statyw nie zawiera implantów
 Tray does not include implants
 Подставка без имплантатов

	3.3462.908
	3.3464.908
	3.3458.908
	3.3460.908
	3.3454.904
	3.3454.906
	3.3454.908
	3.3454.910
	3.3454.912

Statyw na płytki 2,0ChMP 4x2 1/4H
Stand for 2.0ChMP plates 4x2 1/4H
Подставка для пластин 2,0ChMP 4x2 1/4H

14.0304.401



Statyw nie zawiera implantów
Tray does not include implants
Подставка без имплантатов

 **3.3086.514**

 **3.3085.121**

 **3.3086.506**

 **3.4491.906**

 **3.4492.906**

 **3.3733.906**

 **3.3745.907**

 **3.4455.906**

Statyw na płytki 2,0ChMP 4x2 1/4H
Stand for 2.0ChMP plates 4x2 1/4H
Подставка для пластин 2,0ChMP 4x2 1/4H

14.0304.402



Statyw nie zawiera implantów
Tray does not include implants
Подставка без имплантатов

 **3.3798.906**

 **3.3800.906**

 **3.3794.908**

 **3.3796.908**

 **3.4472.904**

 **3.4472.906**

 **3.4494.908**

 **3.4494.910**

STATYWY NA PŁYTKI - UNIWERSALNE
STAND FOR PLATES - UNIVERSAL
ПОДСТАВКА ДЛЯ ПЛАСТИН - УНИВЕРСАЛЬНЫЕ

Statyw na płytki ChMP 4x2 1/4H
Stand for plates ChMP 4x2 1/4H (with cover)
Подставка для для пластин ChMP 4x2 1/4H (с крышкой)

(z pokrywą)
(with cover)
(с крышкой)

14.0301.401



Statyw nie zawiera implantów
 Tray does not include implants
 Подставка без имплантатов

Statyw na płytki ChMP 4x2 1/4H
Stand for plates ChMP 4x2 1/4H
Подставка для для пластин ChMP 4x2 1/4H

(bez pokrywy)
(without cover)
(без крышки)

14.0301.402

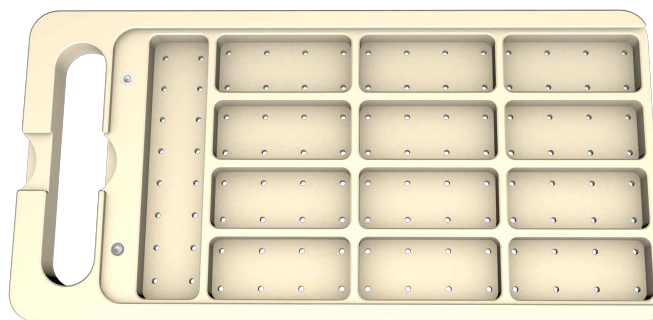

Statyw nie zawiera implantów
 Tray does not include implants
 Подставка без имплантатов

Pokrywa 4x2
Cover 4x2
Покрышка4x2

14.0000.301

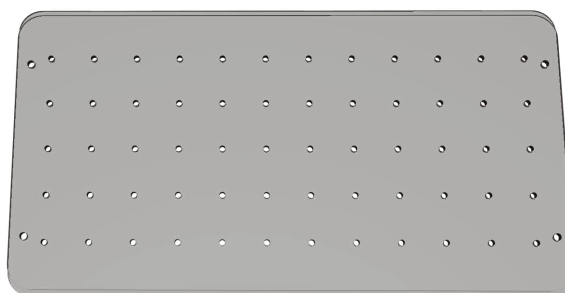

PRZYKŁAD KOMPLETACJI
EXAMPLE OF CONFIGURATION
ПРИМЕР КОМПЛЕКТАЦИИ

WARIANT I VARIANT I ВАРИАНТ I				WARIANT II VARIANT II ВАРИАНТ II			
Pakiet statywów na płytki – jedna pokrywa (max 4) Kit of stands for plates – one cover (max 4) Комплект подставок для пластин - одна крышка (макс. 4)				Osobne statywy na płytki z pokrywkami Separate stands for plates with covers Одиночные подставки для пластин с крышками			
Nazwa Name Название	Nr katalogowy Catalogue No. № по кат. .	Szt. Pcs Шт.		Nazwa Name Название	Nr katalogowy Catalogue No. № по кат. .	Szt. Pcs Шт.	
1	Statyw na płytki ChMP 4x2 1/4H Stand for plates ChMP 4x2 1/4H Подставка для для пластин ChMP 4x2 1/4H	14.0301.402	2	1	Statyw na płytki ChMP 4x2 1/4H Stand for plates ChMP 4x2 1/4H Подставка для для пластин ChMP 4x2 1/4H	14.0301.401	2
2	Cover 4x2 Покрышка4x2	14.0000.301	1				

Statywy/Standz/Подставки

**PRZYKŁAD KOMPLETACJI
EXAMPLE OF CONFIGURATION
ПРИМЕР КОМПЛЕКТАЦИИ**

**STATYWY NA IMPLANTY 1,5/2,0ChMP - DŁOŃ
STANDS FOR 1.5/2.0ChMP IMPLANTS - HAND
ПОДСТАВКА ДЛЯ ИМПЛАНТАТОВ 1,5/2,0ChMP - ЛАДОНЬ**

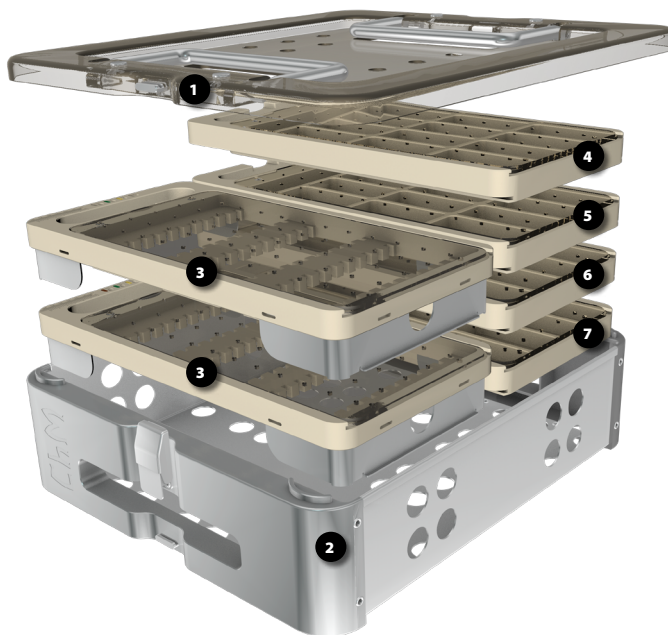

	Nazwa/Name/Название	Nr katalogowy Catalogue No. № по кат.
1	Pokrywa kontenera ChMP 4x4H Container lid for ChMP 4x4H Покрышка для контейнера ChMP 4x4H	14.0301.104
2	Kontener ChMP 4x4H Container for ChMP 4x4H Контейнер ChMP 4x4H	14.0301.103
3	Statyw na wkręty ChMP 4x2 1/2H Stand for ChMP screws 4x2 1/2H Подставка для винтов ChMP 4x2 1/2H	14.0301.501
4	Statyw na płytki 1,5ChMP 4x2 1/4H Stand for 1.5ChMP plates 4x2 1/4H Подставка для пластин 1,5ChMP 4x2 1/4H	14.0303.401
5	Statyw na płytki 1,5ChMP 4x2 1/4H Stand for 1.5ChMP plates 4x2 1/4H Подставка для пластин 1,5ChMP 4x2 1/4H	14.0303.402
6	Statyw na płytki 2,0ChMP 4x2 1/4H Stand for 2.0ChMP plates 4x2 1/4H Подставка для пластин 2,0ChMP 4x2 1/4H	14.0304.401
7	Statyw na płytki 2,0ChMP 4x2 1/4H Stand for 2.0ChMP plates 4x2 1/4H Подставка для пластин 2,0ChMP 4x2 1/4H	14.0304.402

Zestaw ChMP 4x4 H
Set for ChMP 4x4 H
Инструменты для ChMP 4x4 H

15.0301.001

	Nazwa Name Название	Nr katalogowy Catalogue No. № по кат.	Szt. Pcs Шт.
	Instrumentarium ChMP 4x4 1/2H Instrument set for ChMP 4x4 1/2H Инструменты ChMP 4x2 1/2H	15.0301.201	1
	Instrumentarium ChMP 4x2 1/2H Instrument set for ChMP 4x2 1/2H Инструменты ChMP 4x2 1/2H	15.0301.202	1
	Instrumentarium ChMP 4x2 1/2H Instrument set for ChMP 4x2 1/2H Инструменты ChMP 4x2 1/2H	15.0301.203	1
	Pokrywa kontenera ChMP 4x4H ChMP container lid 4x4H Покрышка для контейнера ChMP 4x4H	14.0301.102	1
	Kontener ChMP 4x4H Container ChMP 4x4H Контейнер ChMP 4x4H	14.0301.101	1











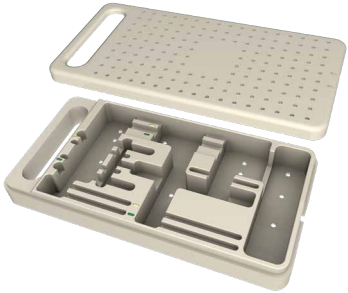



Instrumentarium ChMP 4x4 1/2H
Instrument set for ChMP 4x4 1/2H
Инструменты ChMP 4x4 1/2H

15.0301.201

	Nazwa Name Название	Nr katalogowy Catalogue No. № по кат.	Szt. Pcs Шт.
	Paleta na instrumentarium ChMP 4x4 1/2H Tray for ChMP instrument set 4x4 1/2H Поддон для инструментов для ChMP 4x4 1/2H	14.0301.201	1
	Szczypce do gięcia płytek Bending forceps for plates Клещи для выгибания пластин	40.8460.000	2
	Ustalacz odłamków kości 135mm Bone holding forceps 135mm Костодержатель 135мм	40.4150.000	1
	Ustalacz odłamków kości 90mm Bone holding forceps 90mm Костодержатель 90мм	40.4150.090	1
	Szczypce do cięcia płytek Plate cutting pliers Клещи для резания пластин	40.8406.000	1
	Szczypce redukcyjne Reduction forceps Клещи сокращённые	40.8461.000	1
	Prowadnica wiertła 1,2 Drill guide 1.2 Направитель сверла 1,2	40.8462.121	1
	Prowadnica wiertła 1,5 Drill guide 1.5 Направитель сверла 1,5	40.8462.150	1
	Prowadnica wiertła 2,0 Drill guide 2.0 Направитель сверла 2,0	40.8462.200	1

Instrumentarium ChMP 4x2 1/2H
Instrument set for ChMP 4x2 1/2H
Инструменты ChMP 4x2 1/2H

15.0301.202







	Nazwa Name Название	Nr katalogowy Catalogue No. № по кат.	Szt. Pcs Шт.
	Statyw na instrumentarium ChMP 4x2 1/2H Stand for instrument set for ChMP 4x2 1/2H Подставка для инструментов ChMP 4x2 1/2H	14.0301.202	1
	Prowadnica wiertła 1,2/1,5 Drill guide 1.2/1.5 Направитель сверла 1,2/1,5	40.8464.000	1
	Prowadnica wiertła 1,5/2,0 Drill guide 1.5/2.0 Направитель сверла 1,5/2,0	40.8465.000	1
	Wiertło 1,2/70 Drill 1.2/70 Сверло 1,2/70	40.8468.670	1
	Wiertło 1,5/70 Drill 1.5/70 Сверло 1,5/70	40.8469.670	1
	Wiertło 1,5/70 Drill 1.5/70 Сверло 1,5/70	40.8470.670	1
	Wiertło 2,0/70 Drill 2.0/70 Сверло 2,0/70	40.8471.670	1
	Wzorzec głębokości Depth measure Измеритель глубины	40.4640.500	1
	Pogłębiacz Countersink Зенкер	40.8478.000	1
	Grot X Screwdriver tip X Наконечник X	40.6449.051	1
	Grot X Screwdriver tip X Наконечник X	40.6449.053	1
	Grot X z chwytakiem Screwdriver tip X with holder Наконечник X с держателем	40.8473.000	1
	Grot X z chwytakiem Screwdriver tip X with holder Наконечник X с держателем	40.8474.000	1
	Rękojeść z szybkozłączem Quick coupling handle Рукоятка с быстроразъемным соединением	40.6405.300	1

Instrumentarium ChMP 4x2 1/2H
Instrument set for ChMP 4x2 1/2H
Инструменты ChMP 4x2 1/2H



15.0301.203

	Nazwa Name Название	Nr katalogowy Catalogue No. № по кат.	Szt. Pcs Шт.
	Statyw na instrumentarium ChMP 4x2 1/2H Stand for instrument set for ChMP 4x2 1/2H Подставка для инструментов ChMP 4x2 1/2H	14.0301.203	1
	Drut prowadzący 0,8/150 Guide rod 0.8/150 Спица-направитель 0,8/150	40.8132.150	4
	Drut prowadzący 1,0/150 Guide rod 1.0/150 Спица-направитель 1,0/150	40.8133.150	4
	Drut prowadzący 1,2/150 Guide rod 1.2/150 Спица-направитель 1,2/150	40.6466.150	4
	Pinceta anatomiczna delikatna 10,5cm Dissecting forceps delicate 10.5cm Пинцет анатомический деликатный 10,5см	30.3376.000	1
	Podważka Elevator Элеватор	40.4984.000	1
	Podważka Elevator Элеватор	40.4986.000	1
	hak Hook Крючок	40.8477.000	1

**INNE NARZĘDZIA
OTHER INSTRUMENTS
ДРУГИЕ ИНСТРУМЕНТЫ**

		Nazwa/Name/Название	Nr katalogowy Catalogue No. № по кат.
		Wkrętak X Screwdriver X Отвертка X	 40.8422.000
		Wkrętak X Screwdriver X Отвертка X	 40.8422.002

**Narzędzia opcjonalne do wkrętów kompresyjnych 3.6658
Optional tools for comperssion screws 3.6658
Инструменты для компрессионных винтов – опционально 3.6658**

	Wiertło stopniowe 1,2-10 Gradual drill 1.2-10 Сверло фазное 1,2-10	40.8424.010
	Wiertło stopniowe 1,2-12 Gradual drill 1.2-12 Сверло фазное 1,2-12	40.8424.012
	Wiertło stopniowe 1,2-14 Gradual drill 1.2-14 Сверло фазное 1,2-14	40.8424.014
	Wiertło stopniowe 1,2-16 Gradual drill 1.2-16 Сверло фазное 1,2-16	40.8424.016
	Wiertło stopniowe 1,2-18 Gradual drill 1.2-18 Сверло фазное 1,2-18	40.8424.018

SYSTEM IMPLANTÓW BLOKOWANYCH - DŁOŃ
LOCKING IMPLANTS SYSTEM - HAND
СИСТЕМА БЛОКИРУЮЩИХ ИМПЛАНТАТОВ - ЛАДОНЬ

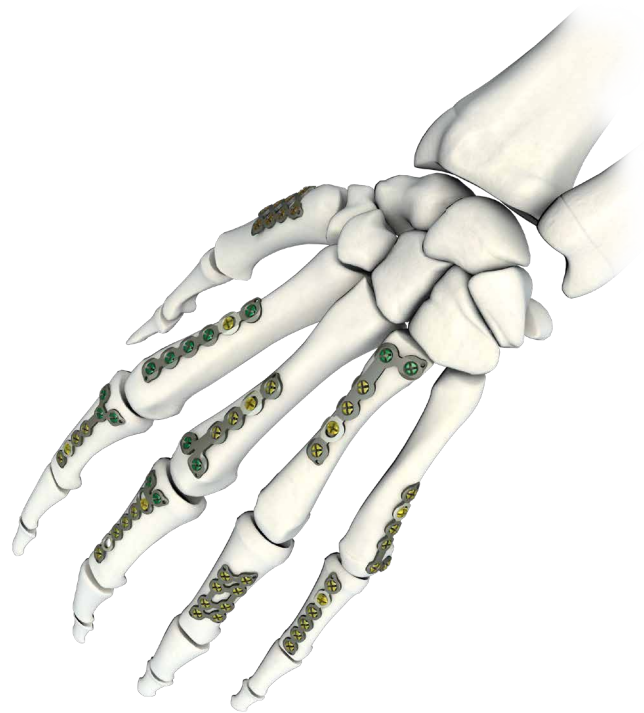



3,0ChLP płytką prostą
3.0ChLP straight plate
3,0ChLP пластина прямая



3.8010.120

20



3,0ChLP płytką prostą
3.0ChLP straight plate
3,0ChLP пластина прямая

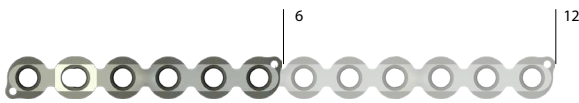

3.8010.006

3.8010.012

6

12



3,0ChLP płytką prostą
3.0ChLP straight plate
3,0ChLP пластина прямая

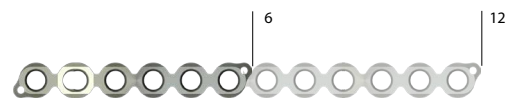

3.8010.206

3.8010.212

6

12



3,0ChLP płytką L
3.0ChLP plate L
3,0ChLP пластина L



3.8011.005

3.8012.005

2/5



3,0ChLP płytką L
3.0ChLP plate L
3,0ChLP пластина L



3.8011.205

3.8012.205

2/5



3,0ChLP płytką L 100°
3.0ChLP plate L 100°
3,0ChLP пластина L 100°



3.8013.005

3.8014.005

2/5



3,0ChLP płytką L 100°
3.0ChLP plate L 100°
3,0ChLP пластина L 100°



3.8013.205

3.8014.205

2/5



3,0ChLP płytką T
3.0ChLP plate T
3,0ChLP пластина T

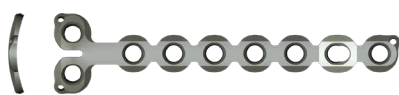

3.8016.007

2/7



3,0ChLP płytką T
3.0ChLP plate T
3,0ChLP пластина T



3.8016.207

2/7



3,0ChLP płytka Y
3.0ChLP plate Y
3,0ChLP пластина Y



3.8017.007
 2/7



3,0ChLP płytka Y
3.0ChLP plate Y
3,0ChLP пластина Y



3.8017.207
 2/7



3,0ChLP płytka korekcyjna
3.0ChLP correction plate
3,0ChLP коррекционная пластина

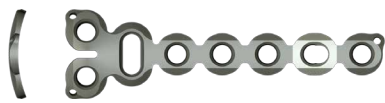

3.8023.006
 2/6



3,0ChLP płytka korekcyjna
3.0ChLP correction plate
3,0ChLP коррекционная пластина



3.8023.206
 2/6



3,0ChLP płytka T
3.0ChLP plate T
3,0ChLP пластина T

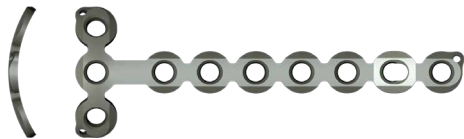

3.8015.007
 3/7



3,0ChLP płytka T
3.0ChLP plate T
3,0ChLP пластина T



3.8015.207
 3/7



3,0ChLP płytka H
3.0ChLP plate H
3,0ChLP пластина H



3.8018.007
 3/7



3,0ChLP płytka H
3.0ChLP plate H
3,0ChLP пластина H



3.8018.207
 3/7



3,0ChLP płytka równoległobok
3.0ChLP parallelogram plate
3,0ChLP пластина параллельная



3.8019.004



3.8020.004



2/4



3,0ChLP płytka równoległobok
3.0ChLP parallelogram plate
3,0ChLP пластина параллельная



3.8019.204





3.8020.204



2/4

Ti	3,0ChLP płytka trapezowa 3,0ChLP trapezium plate 3,0ChLP пластина трапецевидная
1.2	
L	3.8021.003
R	3.8022.003
	2/3

Ti	3,0ChLP płytka trapezowa 3,0ChLP trapezium plate 3,0ChLP пластина трапецевидная
0.8	
L	3.8021.203
R	3.8022.203
	2/3

Ti	3,0ChLP płytka prostokąt 3,0ChLP rectangular plate 3,0ChLP пластина прямоугольник
1.2	
	3.8025.004
	2/4

Ti	3,0ChLP płytka prostokąt 3,0ChLP rectangular plate 3,0ChLP пластина прямоугольник
0.8	
	3.8025.204
	2/4

Ti	3,0ChLP płytka prostokąt 3,0ChLP rectangular plate 3,0ChLP пластина прямоугольник
1.2	
	3.8024.002 3.8024.008
	2/2 2/8



Ti	3,0ChLP płytka prostokąt 3,0ChLP rectangular plate 3,0ChLP пластина прямоугольник
0.8	
	3.8024.202 3.8024.208
	2/2 2/8

TiA	Podkładka pod wkręt 1,2 Washer 1.2 Шайба под винт 1,2
1.2	
	3.1951.017
	5,5
	1

TiA	Podkładka pod wkręt 0,8 Washer 0.8 Шайба под винт 0,8
0.8	
	3.1951.016
	4,5
	1



Ti	Mikroplątka Microplate Минипластина
0.8	
	3.7309.000
Len	8
	1

3,0ChLP wkręt VA 1,5
3.0ChLP screw VA 1.5
3,0ChLP винт VA 1,5

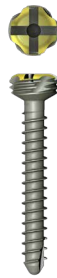
Len	TiA		
6			
7			
8			
9			
10			
11			
12			
13			
14			
15			
16			
17			
18			
19			
20			
Szt. Pcs Шт.	 5		





3,0ChLP wkręt VA 2,0
3.0ChLP screw VA 2.0
3,0ChLP винт VA 2,0

Len	TiA		
6			
7			
8			
9			
10			
11			
12			
13			
14			
15			
16			
17			
18			
19			
20			
22*			
24*			
26*			
28*			
30*			
Szt. Pcs Шт.	 5		



3,0ChLP wkręt VA 2,3
3.0ChLP screw VA 2.3
3,0ChLP винт VA 2,3

Len	TiA		
6			
7			
8			
9			
10			
11			
12			
13			
14			
15			
16			
17			
18			
19			
20			
22*			
24*			
26*			
28*			
30*			
Szt. Pcs Шт.	 5		



* Dodatkowo dostępne
 Additionally Available
 Дополнительно доступные



* Dodatkowo dostępne
 Additionally Available
 Дополнительно доступные

3,0ChLP wkręt 1,2
3.0ChLP screw 1.2
3,0ChLP винт 1,2

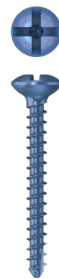
Len	TiA	
5*	3.8003.605	
6	3.8003.606	
7	3.8003.607	
8	3.8003.608	
9	3.8003.609	
10	3.8003.610	
11*	3.8003.611	
12*	3.8003.612	
13*	3.8003.613	
14*	3.8003.614	
15*	3.8003.615	
Szt. Pcs Шт.	 5	



3,0ChLP wkręt 1,5
3.0ChLP screw 1.5
3,0ChLP винт 1,5



Len	TiA	
6	3.8004.606	
7	3.8004.607	
8	3.8004.608	
9	3.8004.609	
10	3.8004.610	
11	3.8004.611	
12	3.8004.612	
13	3.8004.613	
14	3.8004.614	
15	3.8004.615	
16	3.8004.616	
17	3.8004.617	
18	3.8004.618	
19	3.8004.619	
20	3.8004.620	
Szt. Pcs Шт.	 5	



* Dodatkowo dostępne
 Additionally Available
 Дополнительно доступные



* Dodatkowo dostępne
 Additionally Available
 Дополнительно доступные

3,0ChLP wkręt 2,0
3.0ChLP screw 2.0
3,0ChLP винт 2,0

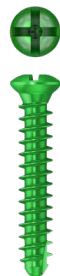
Len	TiA	
6	3.8005.606	
7	3.8005.607	
8	3.8005.608	
9	3.8005.609	
10	3.8005.610	
11	3.8005.611	
12	3.8005.612	
13	3.8005.613	
14	3.8005.614	
15	3.8005.615	
16	3.8005.616	
17	3.8005.617	
18	3.8005.618	
19	3.8005.619	
20	3.8005.620	
22*	3.8005.622	
24*	3.8005.624	
26*	3.8005.626	
28*	3.8005.628	
30*	3.8005.630	
Szt. Pcs Шт.	 5	



3,0ChLP wkręt 2,3
3.0ChLP screw 2.3
3,0ChLP винт 2,3

Len	TiA	
6	3.8006.606	
7	3.8006.607	
8	3.8006.608	
9	3.8006.509	
10	3.8006.610	
11	3.8006.611	
12	3.8006.612	
13	3.8006.613	
14	3.8006.614	
15	3.8006.615	
16	3.8006.616	
17	3.8006.617	
18	3.8006.618	
19	3.8006.619	
20	3.8006.620	
22*	3.8006.622	
24*	3.8006.624	
26*	3.8006.626	
28*	3.8006.628	
30*	3.8006.630	
Szt. Pcs Шт.	 5	



* Dodatkowo dostępne
 Additionally Available
 Дополнительно доступные

* Dodatkowo dostępne
 Additionally Available
 Дополнительно доступные

Statyw na wkręty 3,0ChLP 4x2 1/2H
Stand for 3.0ChLP screws 4x2H 1/2H
Подставка для винтов 3,0ChLP 4x2 1/2H

14.0203.501

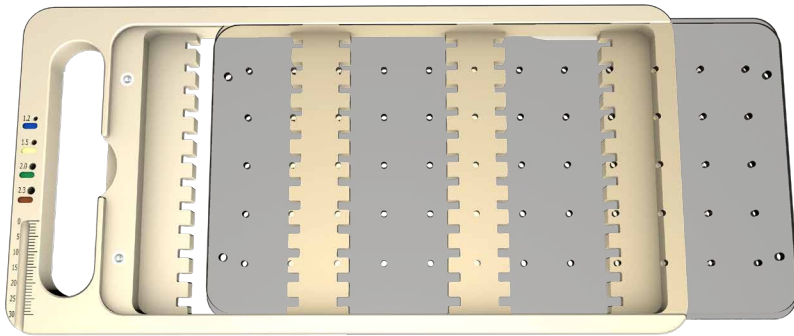

Szt.
Pcs
Шт.



36

Statyw nie zawiera implantów
 Stand does not include implants
 Подставка без имплантатов

Max długość wkrętów 20mm
 Max screw length 20mm
 Максимальная длина винта 20мм

Statyw na płytki 3,0ChLP 4x2 1/4H
Stand for plates 3.0ChLP 4x2 1/4H
Подставка для для пластин 3,0ChLP 4x2 1/4H **14.0203.403**

Plate thickness  1.2mm



 **3.8010.006**

 **3.8010.012**

 **3.8011.005**

 **3.8012.005**

 **3.8013.005**

 **3.8014.005**

 **3.8015.007**

 **3.8016.007**

 **3.8017.007**

 **3.8023.006**

Statyw nie zawiera implantów
 Stand does not include implants
 Подставка без имплантатов

Statyw na płytki 3,0ChLP 4x2 1/4H
Stand for plates 3.0ChLP 4x2 1/4H
Подставка для для пластин 3,0ChLP 4x2 1/4H **14.0203.404**

Plate thickness  1.2mm



 **3.8018.007**

 **3.8019.004**

 **3.8020.004**

 **3.8021.003**

 **3.8022.003**

 **3.8024.002**

 **3.8024.008**

 **3.8025.004**

Statyw nie zawiera implantów
 Stand does not include implants
 Подставка без имплантатов

Statyw na płytki 3,0ChLP 4x2 1/4H
Stand for plates 3.0ChLP 4x2 1/4H
Подставка для для пластин 3,0ChLP 4x2 1/4H

14.0203.405

Plate thickness  0.8mm



Statyw nie zawiera implantów
 Stand does not include implants
 Подставка без имплантатов

 **3.8010.206**

 **3.8010.212**

 **3.8011.205**

 **3.8012.205**

 **3.8013.205**

 **3.8014.205**

 **3.8015.207**

 **3.8016.207**

 **3.8017.207**

 **3.8023.206**

Statyw na płytki 3,0ChLP 4x2 1/4H
Stand for plates 3.0ChLP 4x2 1/4H
Подставка для для пластин 3,0ChLP 4x2 1/4H

14.0203.406

Plate thickness  0.8mm



Statyw nie zawiera implantów
 Stand does not include implants
 Подставка без имплантатов

 **3.8018.207**

 **3.8019.204**

 **3.8020.204**

 **3.8021.203**

 **3.8022.203**

 **3.8024.202**

 **3.8024.208**

 **3.8025.204**

STATYWY NA PŁYTKI - UNIWERSALNE
STAND FOR PLATES - UNIVERSAL
ПОДСТАВКА ДЛЯ ПЛАСТИН - УНИВЕРСАЛЬНЫЕ

Statyw na płytki 3,0ChLP 4x2 1/4H
Stand for plates 3,0ChLP 4x2 1/4H
Подставка для для пластин 3,0ChLP 4x2 1/4H

(z pokrywą)
(with cover)
(с крышкой)

14.0203.401



Statyw nie zawiera implantów
 Stand does not include implants
 Подставка без имплантатов

Statyw na płytki 3,0ChLP 4x2 1/4H
Stand for plates 3,0ChLP 4x2 1/4H
Подставка для для пластин 3,0ChLP 4x2 1/4H

(bez pokrywy)
(without cover)
(без крышки)

14.0203.402

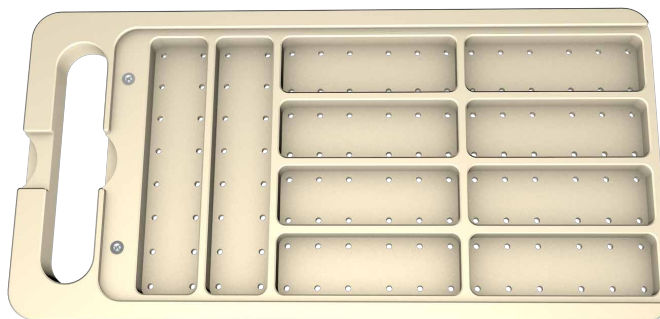

Statyw nie zawiera implantów
 Stand does not include implants
 Подставка без имплантатов

Pokrywa 4x2
Cover 4x2
Покрышка 4x2

14.0000.301

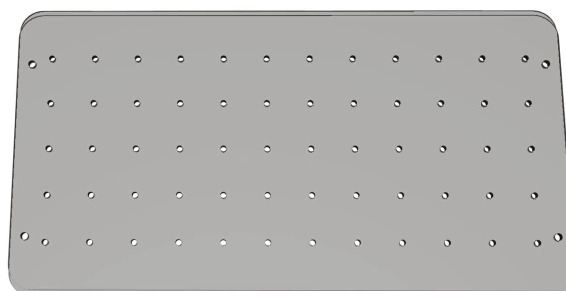

PRZYKŁADY KOMPLETACJI
EXAMPLE OF CONFIGURATION
ПРИМЕР КОМПЛЕКТАЦИИ

WARIANT I VARIANT I ВАРИАНТ I				WARIANT II VARIANT II ВАРИАНТ II			
Pakiet statywów na płytce – jedna pokrywa (max 4) Kit of stands for plates – one cover (max 4) Комплект подставок для пластин - одна покрывка (макс. 4)				Osobne statywy na płytce z pokrywkami Separate stands for plates with covers Одиночные подставки для пластин с покрывками			
Nazwa Name Название	Nr katalogowy Catalogue No. № по кат.	Szt. Pcs Шт.		Nazwa Name Название	Nr katalogowy Catalogue No. № по кат.	Szt. Pcs Шт.	
1 Statyw na płytce 3,0ChLP 4x2 1/4H Stand for plates 3,0ChLP 4x2 1/4H Подставка для для пластин 3,0ChLP 4x2 1/4H	14.0203.402	2		1 Statyw na płytce 3,0ChLP 4x2 1/4H Stand for plates 3,0ChLP 4x2 1/4H Подставка для для пластин 3,0ChLP 4x2 1/4H	14.0203.401	2	
2 Pokrywa 4x2 Cover 4x2 Покривка4x2	14.0000.301	1					

PRZYKŁADY KOMPLETACJI
EXAMPLE OF CONFIGURATION
ПРИМЕР КОМПЛЕКТАЦИИ

STATYWY NA IMPLANTY 3,0ChLP
STANDS FOR 3.0ChLP IMPLANTS
ПОДСТАВКА ДЛЯ ИМПЛАНТАТОВ 3,0ChLP

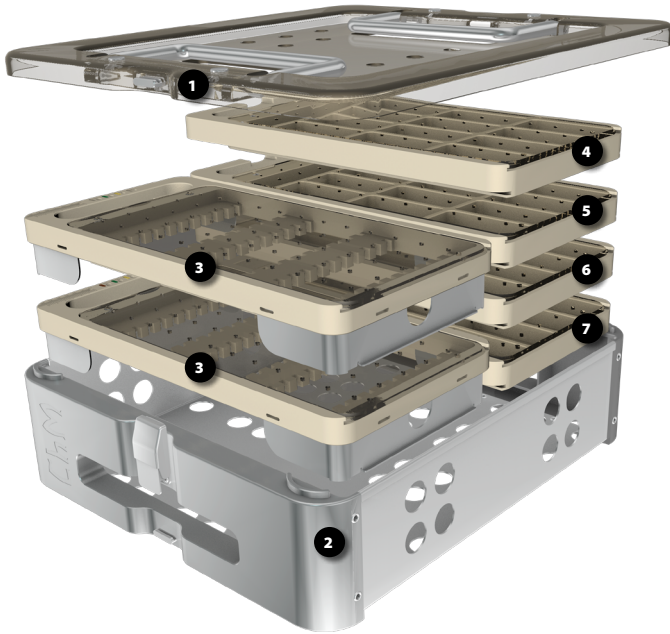

	Nazwa Name Название	Nr katalogowy Catalogue No. № по кат.
1	Pokrywa kontenera 3,0ChLP 4x4H Container lid 3.0ChLP 4x4H Покрышка д. контейнера 3,0ChLP 4x4H	14.0203.105
2	Kontener 3,0ChLP 4x4H Container for 3.0ChLP 4x4H Контейнер 3,0ChLP 4x4H	14.0203.104
3	Statyw na wkręty 3,0ChLP 4x2 1/2H Stand for 3.0ChLP screws 4x2H 1/2H Подставка для винтов 3,0ChLP 4x2 1/2H	14.0203.501
4	Statyw na płytki 3,0ChLP 4x2 1/4H Stand for plates 3.0ChLP 4x2 1/4H Подставка для для пластин 3,0ChLP 4x2 1/4H	14.0203.403
5	Statyw na płytki 3,0ChLP 4x2 1/4H Stand for plates 3.0ChLP 4x2 1/4H Подставка для для пластин 3,0ChLP 4x2 1/4H	14.0203.404
6	Statyw na płytki 3,0ChLP 4x2 1/4H Stand for plates 3.0ChLP 4x2 1/4H Подставка для для пластин 3,0ChLP 4x2 1/4H	14.0203.405
7	Statyw na płytki 3,0ChLP 4x2 1/4H Stand for plates 3.0ChLP 4x2 1/4H Подставка для для пластин 3,0ChLP 4x2 1/4H	14.0203.406

Zestaw 3,0ChLP 4x4 H
Set for 3.0ChLP 4x4 H
Инструменты для 3,0ChLP 4x4 H

15.0203.001

	Nazwa Name Название	Nr katalogowy Catalogue No. № по кат.	Szt. Pcs Шт.
	Instrumentarium 3,0ChLP 4x4 1/2H Instrument set for 3.0ChLP 4x4 1/2H Инструменты 3.0ChLP 4x2 1/2H	15.0203.201	1
	Instrumentarium 3,0ChLP 4x2 1/2H Instrument set for 3.0ChLP 4x2 1/2H Инструменты 3.0ChLP 4x2 1/2H	15.0203.202	1
	Instrumentarium 3,0ChLP 4x2 1/2H Instrument set for 3.0ChLP 4x2 1/2H Инструменты 3.0ChLP 4x2 1/2H	15.0203.203	1
	Pokrywa kontenera 3,0ChLP 4x4H 3.0ChLP container lid 4x4H Покрышка для контейнера 3,0ChLP 4x4H	14.0203.102	1
	Kontener 3,0ChLP 4x4H Container 3.0ChLP 4x4H Контейнер 3,0ChLP 4x4H	14.0203.101	1











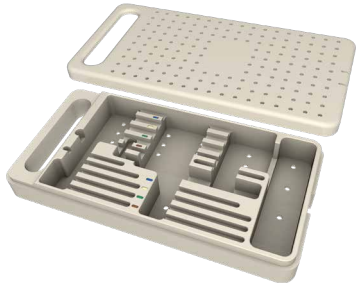







Instrumentarium 3,0ChLP 4x4 1/2H
Instrument set for 3.0ChLP 4x4 1/2H
Инструменты 3.0ChLP 4x4 1/2H

15.0203.201

	Nazwa Name Название	Nr katalogowy Catalogue No. № по кат.	Szt. Pcs Шт.
	Paleta na instrumentarium 3,0ChLP 4x4 1/2H Tray for 3.0ChLP instrument set 4x4 1/2H Поддон для инструментов для 3,0ChLP 4x4 1/2H	14.0203.201	1
	Szczypce do gięcia płytek Bending forceps for plates Клещи для выгибания пластин	40.8460.100	2
	Ustalacz odłamków kości 135mm Bone holding forceps 135mm Костодержатель 135мм	40.4150.000	1
	Ustalacz odłamków kości 90mm Bone holding forceps 90mm Костодержатель 90мм	40.4150.090	1
	Szczypce do cięcia płytek Plate cutting pliers Клещи для резания пластин	40.8406.100	1
	Szczypce redukcyjne Reduction forceps Клещи сокращённые	40.8461.000	1
	Prowadnica wiertła 0,9 Drill guide 0.9 Направитель сверла 0,9	40.8462.090	1
	Prowadnica wiertła 1,2 Drill guide 1.2 Направитель сверла 1,2	40.8462.120	1
	Prowadnica wiertła 1,5 Drill guide 1.5 Направитель сверла 1,5	40.8462.150	1
	Prowadnica wiertła 2,0 Drill guide 2.0 Направитель сверла 2,0	40.8462.200	1
	Prowadnica wiertła 1,8 Drill guide 1.8 Направитель сверла 1,8	40.8462.180	1
	Prowadnica wiertła 2,3 Drill guide 2.3 Направитель сверла 2,3	40.8462.230	1









Instrumentarium 3,0ChLP 4x2 1/2H
Instrument set for 3.0ChLP 4x2 1/2H
Инструменты 3.0ChLP 4x2 1/2H

15.0203.202

	Nazwa Name Название	Nr katalogowy Catalogue No. № по кат.	Szt. Pcs Шт.
	Statyw na instrumentarium 3,0ChLP 4x2 1/2H Stand for instrument set for 3.0ChLP 4x2 1/2H Подставка для инструментов 3,0ChLP 4x2 1/2H	14.0203.202	1
	Prowadnica wiertła 0,9/1,2 Drill guide 09/1.2 Направитель сверла 0,9/1,2	40.8463.000	1
	Prowadnica wiertła 1,2/1,5 Drill guide 1.2/1.5 Направитель сверла 1,2/1,5	40.8464.000	1
	Prowadnica wiertła 1,5/2,0 Drill guide 1.5/2.0 Направитель сверла 1,5/2,0	40.8465.000	1
	Prowadnica wiertła 1,8/2,3 Drill guide 1.8/2.3 Направитель сверла 1,8/2,3	40.8466.000	1
	Wiertło 0,9/60 Drill 0.9/60 Сверло 0,9/60	40.8467.660	1
	Wiertło 1,2/60 Drill 1.2/60 Сверло 1,2/60	40.8468.660	1
	Wiertło 1,2/70 Drill 1.2/70 Сверло 1,2/70	40.8468.670	1
	Wiertło 1,5/70 Drill 1.5/70 Сверло 1,5/70	40.8469.670	1
	Wiertło 1,5/70 Drill 1.5/70 Сверло 1,5/70	40.8470.670	1
	Wiertło 2,0/70 Drill 2.0/70 Сверло 2,0/70	40.8471.670	1
	Wiertło 1,8/70 Drill 1.8/70 Сверло 1,8/70	40.8479.670	1
	Wiertło 2,3/70 Drill 2.3/70 Сверло 2,3/70	40.8472.670	1
	Wzorzec głębokości Depth measure Измеритель глубины	40.4640.500	1
	Pogłębiacz Countersink Зенкер	40.8478.000	1
	Grot X Screwdriver tip X Наконечник X	40.6449.057	1
	Grot X z chwytakiem Screwdriver tip X with holder Наконечник X с держателем	40.8475.000	1
	Rękojeść z szybkozłączem Screwdriver tip X with holder Наконечник X с держателем	40.6405.300	1

Instrumentarium 3,0ChLP 4x2 1/2H
Instrument set for 3.0ChLP 4x2 1/2H
Инструменты 3.0ChLP 4x2 1/2H

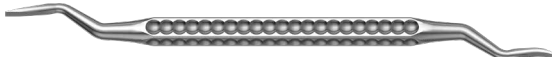
15.0203.203

	Nazwa Name Название	Nr katalogowy Catalogue No. № по кат.	Szt. Pcs Шт.
	Statyw na instrumentarium 3,0ChLP 4x2 1/2H Stand for instrument set for 3.0ChLP 4x2 1/2H Подставка для инструментов 3,0ChLP 4x2 1/2H	14.0203.203	1
	Drut prowadzący 0,8/150 Guide rod 0.8/150 Спица-направитель 0,8/150	40.8132.150	4
	Drut prowadzący 1,0/150 Guide rod 1.0/150 Спица-направитель 1,0/150	40.8133.150	4
	Drut prowadzący 1,2/150 Guide rod 1.2/150 Спица-направитель 1,2/150	40.6466.150	4
	Pinceta anatomiczna delikatna 10,5cm Dissecting forceps delicate 10.5cm Пинцет анатомический деликатный 10,5см	30.3376.000	1
	Podważka Elevator Элеватор	40.4984.000	1
	Podważka Elevator Элеватор	40.4986.000	1
	Hook Hook Крючок	40.8477.000	1

INDEX

3.1951.016	27	3.8000.612	28	3.8006.616	29	40.8460.000	19
3.1951.017	27	3.8000.613	28	3.8006.617	29	40.8460.100	37
3.3085.121	9, 14	3.8000.614	28	3.8006.618	29	40.8461.000	19, 37
3.3086.506	9, 14	3.8000.615	28	3.8006.619	29	40.8462.090	37
3.3086.514	9, 14	3.8000.616	28	3.8006.620	29	40.8462.120	37
3.3340.004	8	3.8000.617	28	3.8006.622	29	40.8462.121	19
3.3342.004	7, 13	3.8000.618	28	3.8006.624	29	40.8462.150	19, 37
3.3344.004	8	3.8000.619	28	3.8006.626	29	40.8462.180	37
3.3346.002	8	3.8000.620	28	3.8006.628	29	40.8462.200	19, 37
3.3348.002	8	3.8001.606	28	3.8010.006	25, 31	40.8462.230	37
3.3406.907	7, 13	3.8001.607	28	3.8010.012	25, 31	40.8463.000	38
3.3416.907	7, 13	3.8001.608	28	3.8010.120	25	40.8464.000	20, 38
3.3454.904	7, 13	3.8001.609	28	3.8010.206	25, 32	40.8465.000	20, 38
3.3454.906	7, 13	3.8001.610	28	3.8010.212	25, 32	40.8466.000	38
3.3454.908	7, 13	3.8001.611	28	3.8011.005	25, 31	40.8467.660	38
3.3454.910	7, 13	3.8001.612	28	3.8011.205	25, 32	40.8468.660	38
3.3454.912	7, 13	3.8001.613	28	3.8012.005	25, 31	40.8468.670	20, 38
3.3454.914	7	3.8001.614	28	3.8012.205	25, 32	40.8469.670	20, 38
3.3454.916	7	3.8001.615	28	3.8013.005	25, 31	40.8470.670	20, 38
3.3454.918	7	3.8001.616	28	3.8013.205	25, 32	40.8471.670	20, 38
3.3458.908	7, 13	3.8001.617	28	3.8014.005	25, 31	40.8472.670	38
3.3460.908	7, 13	3.8001.618	28	3.8014.205	25, 32	40.8473.000	20
3.3462.908	7, 13	3.8001.619	28	3.8015.007	26, 31	40.8474.000	20
3.3462.916	8	3.8001.620	28	3.8015.207	26, 32	40.8475.000	38
3.3464.908	7, 13	3.8001.622	28	3.8016.007	25, 31	40.8477.000	21, 39
3.3464.916	8	3.8001.624	28	3.8016.207	25, 32	40.8478.000	20, 38
3.3472.006	7, 13	3.8001.626	28	3.8017.007	26	40.8479.670	38
3.3472.016	7, 8, 13	3.8001.628	28	3.8017.207	26, 32		
3.3733.906	9, 14	3.8001.630	28	3.8018.007	26, 31		
3.3745.907	9, 14	3.8002.606	28	3.8018.207	26, 32		
3.3794.908	9, 14	3.8002.607	28	3.8019.004	31		
3.3796.908	9, 14	3.8002.608	28	3.8019.204	32		
3.3798.906	9, 14	3.8002.609	28	3.8020.004	31		
3.3800.906	9, 14	3.8002.610	28	3.8020.204	32		
3.4455.906	9, 14	3.8002.611	28	3.8021.003	27, 31		
3.4472.904	9, 14	3.8002.612	28	3.8021.203	27, 32		
3.4472.906	9, 14	3.8002.613	28	3.8022.003	27, 31		
3.4491.906	9, 14	3.8002.614	28	3.8022.203	27, 32		
3.4492.906	9, 14	3.8002.615	28	3.8023.006	26, 31		
3.4494.908	9, 14	3.8002.616	28	3.8023.206	26, 32		
3.4494.910	9, 14	3.8002.617	28	3.8024.002	27, 31		
3.4628.909	7, 13	3.8002.618	28	3.8024.008	27, 31		
3.4719.905	7, 13	3.8002.619	28	3.8024.202	27, 32		
3.4720.905	7, 13	3.8002.620	28	3.8024.208	27, 32		
3.4723.910	7, 13	3.8002.622	28	3.8025.004	27, 31		
3.4723.912	8	3.8002.624	28	3.8025.204	27, 32		
3.6650.504	10	3.8002.626	28	4.5235.010	10		
3.6650.505	10	3.8002.628	28	14.0000.301	15, 16, 33, 34		
3.6650.506	10	3.8002.630	28	14.0203.101	36		
3.6650.507	10	3.8003.605	29	14.0203.102	36		
3.6650.508	10	3.8003.606	29	14.0203.104	35		
3.6650.509	10	3.8003.607	29	14.0203.105	35		
3.6650.510	10	3.8003.608	29	14.0203.201	37		
3.6650.511	10	3.8003.609	29	14.0203.202	38		
3.6650.512	10	3.8003.610	29	14.0203.203	39		
3.6650.513	10	3.8003.611	29	14.0203.401	33, 34		
3.6650.514	10	3.8003.612	29	14.0203.402	33, 34		
3.6650.515	10	3.8003.613	29	14.0203.403	31, 35		
3.6650.516	10	3.8003.614	29	14.0203.404	31, 35		
3.6651.505	10	3.8003.615	29	14.0203.405	32, 35		
3.6651.507	10	3.8004.606	29	14.0203.406	32, 35		
3.6651.509	10	3.8004.607	29	14.0203.501	30, 35		
3.6651.511	10	3.8004.608	29	14.0301.101	18		
3.6651.513	10	3.8004.609	29	14.0301.102	18		
3.6651.515	10	3.8004.610	29	14.0301.103	17		
3.6651.517	10	3.8004.611	29	14.0301.104	17		
3.6651.520	10	3.8004.612	29	14.0301.201	19		
3.6658.510	10	3.8004.613	29	14.0301.202	20		
3.6658.512	10	3.8004.614	29	14.0301.203	21		
3.6658.514	10	3.8004.615	29	14.0301.401	15, 16		
3.6658.516	10	3.8004.616	29	14.0301.402	15, 16		
3.6660.504	11	3.8004.617	29	14.0301.501	12, 17		
3.6660.505	11	3.8004.618	29	14.0303.401	13, 17		
3.6660.506	11	3.8004.619	29	14.0303.402	13, 17		
3.6660.507	11	3.8004.620	29	14.0304.401	14, 17		
3.6660.508	11	3.8005.606	29	14.0304.402	14, 17		
3.6660.509	11	3.8005.607	29	15.0203.201	36		
3.6660.510	11	3.8005.608	29	15.0203.202	36		
3.6660.511	11	3.8005.609	29	15.0203.203	36		
3.6660.512	11	3.8005.610	29	15.0301.001	18		
3.6660.513	11	3.8005.611	29	15.0301.201	18, 19		
3.6660.514	11	3.8005.612	29	15.0301.202	18, 20		
3.6660.515	11	3.8005.613	29	15.0301.203	18, 21		
3.6660.516	11	3.8005.614	29	30.3376.000	21, 39		
3.6660.517	11	3.8005.615	29	40.4150.000	19, 37		
3.6660.518	11	3.8005.616	29	40.4150.090	19, 37		
3.6660.519	11	3.8005.617	29	40.4640.500	20, 38		
3.6661.504	11	3.8005.618	29	40.4984.000	21, 39		
3.6661.505	11	3.8005.619	29	40.4986.000	21, 39		
3.6661.506	11	3.8005.620	29	40.6405.300	20, 38		
3.6661.507	11	3.8005.622	29	40.6449.051	20		
3.6661.508	11	3.8005.624	29	40.6449.053	20		
3.6661.509	11	3.8005.626	29	40.6449.057	38		
3.6661.510	11	3.8005.628	29	40.6466.150	21, 39		
3.6661.512	11	3.8005.630	29	40.8132.150	21, 39		
3.6661.514	11	3.8006.509	29	40.8133.150	21, 39		
3.6661.516	11	3.8006.606	29	40.8406.000	19		
3.6661.518	11	3.8006.607	29	40.8406.100	37		
3.7309.000	27	3.8006.608	29	40.8422.000	22		
3.8000.606	28	3.8006.610	29	40.8422.002	22		
3.8000.607	28	3.8006.611	29	40.8424.010	22		
3.8000.608	28	3.8006.612	29	40.8424.012	22		
3.8000.609	28	3.8006.613	29	40.8424.014	22		
3.8000.610	28	3.8006.614	29	40.8424.016	22		
3.8000.611	28	3.8006.615	29	40.8424.018	22		

ChM sp. z o.o.

Lewickie 3b

16-061 Juchnowiec Kościelny

Poland

tel. +48 85 86 86 100

fax +48 85 86 86 101

chm@chm.eu

www.chm.eu



CE 0197