

SYSTEMY KRĘGOSŁUPOWE
SPINE SYSTEMS
СИСТЕМЫ ДЛЯ ПОЗВОНОЧНИКА



OPIS SYMBOLI.....	09.5
SYMBOL DESCRIPTION ОПИСАНИЕ СИМВОЛОВ	
JAK CZYTAĆ KATALOG.....	09.7
HOW TO READ THIS CATALOGUE КАК ЧИТАТЬ КАТАЛОГ	

**ODCINEK SZYJNY
CERVICAL SEGMENT**

ШЕЙНЫЙ ОТДЕЛ..... 09.9

KLATKI MIĘDZYKRĘGOWE SZYJNE.....	09.9
INTERVERTEBRAL CERVICAL CAGES МЕЖПОЗВОНОЧНЫЕ ШЕЙНЫЕ КЕЙДЖИ	
ZESTAW - KLATKI MIĘDZYKRĘGOWE SZYJNE.....	09.12
SET - CERVICAL INTERVERTEBRAL CAGES НАБОР - МЕЖПОЗВОНОЧНЫЕ ШЕЙНЫЕ КЕЙДЖИ	
INSTRUMENTARIUM - KLATKI MIĘDZYKRĘGOWE SZYJNE.....	09.13
INSTRUMENT SET - CERVICAL INTERVERTEBRAL CAGES ИНСТРУМЕНТЫ - МЕЖПОЗВОНОЧНЫЕ ШЕЙНЫЕ КЕЙДЖИ	
KLATKA MIĘDZYKRĘGOWA SZYJNA BLOKOWANA.....	09.16
INTERVERTEBRAL CERVICAL LOCKING CAGE КЕЙДЖ МЕЖПОЗВОНОЧНЫЙ ШЕЙНЫЙ БЛОКИРУЕМЫЙ	
KLATKA MIĘDZYKRĘGOWA SZYJNA BLOKOWANA.....	09.16
INTERVERTEBRAL CERVICAL LOCKING CAGE КЕЙДЖ МЕЖПОЗВОНОЧНЫЙ ШЕЙНЫЙ БЛОКИРУЕМЫЙ	
3D-Ti KLATKA MIĘDZYKRĘGOWA SZYJNA BLOKOWANA.....	09.17
3D-Ti INTERVERTEBRAL CERVICAL LOCKING CAGE 3D-Ti КЕЙДЖ МЕЖПОЗВОНОЧНЫЙ ШЕЙНЫЙ БЛОКИРУЕМЫЙ	
WKREŃ SZYJNY BLOKUJĄCY.....	09.18
CERVICAL LOCKING SCREW ВИНТ ШЕЙНЫЙ БЛОКИРУЮЩИЙ	
STATYW NA IMPLANTY-ZESTAW.....	09.19
STAND FOR IMPLANTS - SET ШТАТИВ НА ИМПЛАНТАТЫ - НАБОР	
INSTRUMENTARIUM DO KLATEK MIĘDZYKRĘGOWYCH SZYJNYCH BLOKOWANYCH.....	09.20
INSTRUMENT SET FOR CERVICAL INTERVERTEBRAL LOCKING CAGES ИНСТРУМЕНТЫ Д/МЕЖПОЗВОНОЧНЫХ ШЕЙНЫХ БЛОК.КЕЙДЖЕЙ	
PLYTKA SZYJNA BLOKOWANA.....	09.24
CERVICAL LOCKING PLATE ПЛАСТИНА ШЕЙНАЯ БЛОКИР.	
PLYTKA SZYJNA BLOKOWANA.....	09.28
CERVICAL LOCKING PLATE ПЛАСТИНА ШЕЙНАЯ БЛОКИР.	
INSTRUMENTARIUM DO PŁYTEK SZYJNYCH.....	09.29
INSTRUMENT SET FOR CERVICAL PLATES ИНСТРУМЕНТЫ ДЛЯ ШЕЙНЫХ ПЛАСТИН	
CHARSPINE OCT ŚRUBA POLIAKSJALNA.....	09.31
CHARSPINE OCT POLYAXIAL SCREW CHARSPINE OCT ВИНТ ПОЛИАКСИАЛЬНЫЙ	
CHARSPINE OCT ŚRUBA POLIAKSJALNA CZĘŚCIOWO GWINTOWANA.....	09.32
CHARSPINE OCT POLYAXIAL SCREW PARTIALLY THREADED CHARSPINE OCT ВИНТ ПОЛИАКСИАЛЬНЫЙ С ЧАСТИЧНОЙ РЕЗЬБОЙ	
CHARSPINE OCT ŁĄCZNIK PRZEGUBOWY (ŁEB DO ŁBA).....	09.33
CHARSPINE OCT ARTICULATED CONNECTOR (HEAD TO HEAD) CHARSPINE OCT СОЕДИНИТЕЛЬ ШАРНИРНЫЙ (ГОЛОВКА К ГОЛОВКЕ)	
CHARSPINE OCT ŁĄCZNIK PRZEGUBOWY (PRĘT DO PRĘTA).....	09.33
CHARSPINE OCT ARTICULATED CONNECTOR (ROD TO ROD) CHARSPINE OCT СОЕДИНИТЕЛЬ ШАРНИРНЫЙ (СТЕРЖЕНЬ К СТЕРЖНЮ)	
CHARSPINE OCT ŁĄCZNIK BOCZNY.....	09.33
CHARSPINE OCT LATERAL CONNECTOR CHARSPINE OCT СОЕДИНИТЕЛЬ ЛАТЕРАЛЬНЫЙ	
CHARSPINE OCT HAK LAMINARNY SZYJNY.....	09.34
CHARSPINE OCT CERVICAL LAMINAR HOOK CHARSPINE OCT КРЮЧОК ЛАМИНАРНЫЙ ШЕЙНЫЙ	
CHARSPINE OCT ŁĄCZNIK WSPÓŁOSIOWY.....	09.34
CHARSPINE OCT AXIAL CONNECTOR CHARSPINE OCT СОЕДИНИТЕЛЬ КОАКСИАЛЬНЫЙ	
CHARSPINE OCT ŁĄCZNIK RÓWNOLEGŁY.....	09.34
CHARSPINE OCT PARALLEL CONNECTOR CHARSPINE OCT СОЕДИНИТЕЛЬ ПАРАЛЛЕЛЬНЫЙ	
CHARSPINE OCT PRĘT Ø6,0/Ø3,5.....	09.35
CHARSPINE OCT ROD Ø6,0/Ø3,5 CHARSPINE OCT СТЕРЖЕНЬ Ø6,0/Ø3,5	
CHARSPINE OCT PRĘT Ø3,5.....	09.35
CHARSPINE OCT ROD Ø3,5 CHARSPINE OCT СТЕРЖЕНЬ Ø3,5	

CHARSPINE OCT PŁYTKA POTYLICZNA OBUSTRONNA.....	09.36
CHARSPINE OCT BILATERAL OCCIPITAL PLATE CHARSPINE OCT ПЛАСТИНА ДЛЯ ЗАТЫЛКА ДВУСТОРОННЯЯ	
CHARSPINE OCT PŁYTKA POTYLICZNA.....	09.36
CHARSPINE OCT OCCIPITAL PLATE CHARSPINE OCT ПЛАСТИНА ДЛЯ ЗАТЫЛКА	
CHARSPINE OCT WKREŃ POTYLICZNY.....	09.37
CHARSPINE OCT OCCIPITAL SCREW CHARSPINE OCT ВИНТ ДЛЯ ЗАТЫЛКА	
CHARSPINE OCT INSTRUMENTARIUM PODSTAWOWE.....	09.38
CHARSPINE OCT INSTRUMENT SET - BASIC CHARSPINE OCT ИНСТРУМЕНТЫ ОСНОВНЫЕ	
CHARSPINE OCT INSTRUMENTARIUM PODSTAWOWE.....	09.40
CHARSPINE OCT INSTRUMENT SET - BASIC CHARSPINE OCT ИНСТРУМЕНТЫ ОСНОВНЫЕ	
CHARSPINE OCT INSTRUMENTARIUM DODATKOWE 1.....	09.40
CHARSPINE OCT INSTRUMENT SET - ADDITIONAL 1 CHARSPINE OCT ИНСТРУМЕНТЫ ДОПОЛНИТЕЛЬНЫЕ 1	
CHARSPINE OCT INSTRUMENTARIUM DODATKOWE 1.....	09.41
CHARSPINE OCT INSTRUMENT SET - ADDITIONAL 1 CHARSPINE OCT ИНСТРУМЕНТЫ ДОПОЛНИТЕЛЬНЫЕ 1	

**ODCINEK PIERSIOWO-ŁĘDŹWIOWY
THORACO-LUMBAR SEGMENT**

ГРУДНО-ПОЯСНИЧНЫЙ ОТДЕЛ..... 09.42

CHARSPINE2 ŚRUBA MONOAKSJALNA.....	09.42
CHARSPINE2 MONOAXIAL SCREW ВИНТ МОНОАКСИАЛЬНЫЙ CHARSPINE2	
CHARSPINE2 ŚRUBA MONOAKSJALNA REDUKCYJNA.....	09.43
CHARSPINE2 MONOAXIAL REDUCTION SCREW ВИНТ МОНОАКСИАЛЬНЫЙ РЕДУКЦИОННЫЙ CHARSPINE2	
CHARSPINE2 ŚRUBA POLIAKSJALNA.....	09.44
CHARSPINE2 POLYAXIAL SCREW ВИНТ ПОЛИАКСИАЛЬНЫЙ CHARSPINE2	
CHARSPINE2 ŚRUBA POLIAKSJALNA REDUKCYJNA.....	09.45
CHARSPINE2 POLYAXIAL REDUCTION SCREW ВИНТ ПОЛИАКСИАЛЬНЫЙ РЕДУКЦИОННЫЙ CHARSPINE2	
CHARSPINE2 ŚRUBA POLIAKSJALNA DO MIEDNICY.....	09.46
CHARSPINE2 POLYAXIAL SCREW FOR PELVIS ВИНТ ПОЛИАКСИАЛЬНЫЙ ДЛЯ ТАЗА CHARSPINE2	
CHARSPINE2 ŚRUBA UNIPLANARNA.....	09.47
CHARSPINE2 UNIPLANAR SCREW CHARSPINE2 ВИНТ УНИПЛАНАРНЫЙ	
CHARSPINE2 ŚRUBA UNIPLANARNA REDUKCYJNA.....	09.48
CHARSPINE2 UNIPLANAR REDUCTION SCREW CHARSPINE2 ВИНТ УНИПЛАНАРНЫЙ РЕДУКЦИОННЫЙ	
PRĘT 6.....	09.49
ROD 6 СТЕРЖЕНЬ 6	
PRĘT ZAKRZYWIONY 6.....	09.50
CURVED ROD 6 СТЕРЖЕНЬ ИЗОГНУТЫЙ 6	
PRĘT ODGIĘTY 6.....	09.51
ANGLED ROD 6 СТЕРЖЕНЬ ИЗОГНУТЫЙ 6	
ŁĄCZNIK POPRZECZNY LITY.....	09.52
CROSSWISE CONNECTOR SOLID ПОПЕРЕЧНЫЙ СОЕДИНИТЕЛЬ СПЛОШНОЙ	
ŁĄCZNIK POPRZECZNY REGULOWANY.....	09.53
CROSSWISE CONNECTOR REGULATED ПОПЕРЕЧНЫЙ РЕГУЛИРУЕМЫЙ СОЕДИНИТЕЛЬ	
ŁĄCZNIK WSPÓŁOSIOWY.....	09.54
AXIAL CONNECTOR КОАКСИАЛЬНЫЙ СОЕДИНИТЕЛЬ	
ŁĄCZNIK RÓWNOLEGŁY.....	09.54
PARALLEL CONNECTOR ПАРАЛЛЕЛЬНЫЙ СОЕДИНИТЕЛЬ	
ŁĄCZNIK RÓWNOLEGŁY.....	09.54
PARALLEL CONNECTOR ПАРАЛЛЕЛЬНЫЙ СОЕДИНИТЕЛЬ	
ŁĄCZNIK KĄTOWY.....	09.55
ANGULAR CONNECTOR УГЛОВОЙ СОЕДИНИТЕЛЬ	
ŁĄCZNIK BOCZNY.....	09.55
LATERAL CONNECTOR СОЕДИНИТЕЛЬ ЛАТЕРАЛЬНЫЙ	

ŁĄCZNIK POPRZECZNY KLAMROWY09.56 CLAMP CROSSWISE CONNECTOR СОЕДИНИТЕЛЬ СКОБООБРАЗНЫЙ ПОПЕРЕЧНЫЙ	INSTRUMENTARIUM DO KLATEK TLIF PEEK09.97 INSTRUMENT SET FOR TLIF PEEK CAGES ИНСТРУМЕНТЫ ДЛЯ КЕЙДЖИ TLIF PEEK
ŁĄCZNIK PRĘTOWY09.56 ROD CONNECTOR СОЕДИНИТЕЛЬ СТЕРЖНЯ	INSTRUMENTARIUM DO KLATEK MIĘDZYKRĘGOWYCH TLIF PEEK (ROZSZERZENIE)09.99 INSTRUMENT SET FOR TLIF PEEK INTERVERTEBRAL CAGES (EXTENDED) ИНСТРУМЕНТЫ ДЛЯ МЕЖПОЗВОНОЧНЫХ КЕЙДЖИ TLIF PEEK (РАСШИРЕННЫЕ)
NAKI KRĘGOSŁUPOWE09.57 SPINAL HOOKS ПОЗВОНОЧНЫЕ КРЮЧКИ	ALIF PEEK KLATKA MIĘDZYKRĘGOWA ŚREDNIA09.101 ALIF PEEK INTERVERTEBRAL CAGE, MEDIUM ALIF PEEK МЕЖПОЗВОНОЧНЫЙ КЕЙДЖ СРЕДНИЙ
PALETY NA IMPLANTY09.59 PALETTES FOR IMPLANTS ПОДДОНЫ ДЛЯ ИМПЛАТОВ	ALIF PEEK KLATKA MIĘDZYKRĘGOWA DUŻA09.101 ALIF PEEK INTERVERTEBRAL CAGE, LARGE ALIF PEEK МЕЖПОЗВОНОЧНЫЙ КЕЙДЖ БОЛЬШОЙ
PALETY NA IMPLANTY09.62 PALETTES FOR IMPLANTS ПОДДОНЫ ДЛЯ ИМПЛАТОВ	INSTRUMENTARIUM DO KLATEK MIĘDZYKRĘGOWYCH ALIF PEEK09.102 INSTRUMENT SET FOR ALIF PEEK INTERVERTEBRAL CAGES ИНСТРУМЕНТЫ ДЛЯ МЕЖПОЗВОНОЧНЫХ КЕЙДЖИ ALIF PEEK
PALETY NA IMPLANTY09.63 PALETTES FOR IMPLANTS ПОДДОНЫ ДЛЯ ИМПЛАТОВ	ALIF PEEK KLATKA MIĘDZYK. BLOK., ŚREDNIA09.104 ALIF PEEK INTERVERT. LOCKING CAGE, MEDIUM ALIF PEEK МЕЖПОЗВОН. БЛОК. КЕЙДЖ, СРЕДНИЙ
INSTRUMENTARIUM DO KRĘGOSŁUPA CHARSPINE2 PODSTAWOWE09.65 INSTRUMENT SET FOR CHARSPINE2 SPINE STABILIZER - BASIC ИНСТРУМЕНТЫ ДЛЯ СТАБИЛИЗАТОРА ПОЗВОНОЧНИКА CHARSPINE2 ОСНОВНЫЕ	ALIF PEEK KLATKA MIĘDZYK. BLOK., DUŻA09.104 ALIF PEEK INTERVERT. LOCKING CAGE, LARGE ALIF PEEK МЕЖПОЗВОН. БЛОК. КЕЙДЖ, БОЛЬШОЙ
NARZĘDZIA DODATKOWE09.71 ADDITIONAL INSTRUMENTS ДОПОЛНИТЕЛЬНЫЕ ИНСТРУМЕНТЫ	INSTRUMENTARIUM DO KLATEK MIĘDZYKRĘGOWYCH BLOKOWANYCH ALIF PEEK 15.0905.00109.105 INSTRUMENT SET FOR ALIF PEEK INTERVERTEBRAL LOCKING CAGES 15.0905.001 ИНСТРУМЕНТЫ ДЛЯ МЕЖПОЗВОНОЧНЫХ БЛОКИРУЕМЫХ КЕЙДЖИ ALIF PEEK 15.0905.001
SPOSOBY KOMPLETACJI KONTENERÓW09.74 CONTAINERS ARRANGEMENT СПОСОБЫ КОМПЛЕКТАЦИИ КОНТЕЙНЕРОВ	SYSTEM IMPLANTÓW REGULOWANYCH VBR09.107 EXPANDABLE VBR IMPLANTS SYSTEM СИСТЕМА ИМПЛАТОВ РЕГУЛИРУЕМЫХ VBR
CHARSPINE2 MIS ŚRUBA POLIAKSJALNA09.76 CHARSPINE2 MIS POLYAXIAL SCREW CHARSPINE2 MIS ВИНТ ПОЛИАКСИАЛЬНЫЙ	INSTRUMENTARIUM SYSTEM IMPLANTÓW REGULOWANYCH VBR 15.0914.101 09.109 INSTRUMENT SET FOR EXPANDABLE VBR IMPLANTS 15.0914.101 ИНСТРУМЕНТЫ-СИСТЕМА ИМПЛАТОВ РЕГУЛИРУЕМЫХ VBR 15.0914.101
CHARSPINE2 MIS PRĘT 609.77 CHARSPINE2 MIS ROD 6 CHARSPINE2 MIS СТЕРЖЕНЬ 6	SYSTEM IMPLANTÓW SIATKOWYCH VBR09.111 MESH VBR IMPLANT SYSTEM СЕТЧАТАЯ СИСТЕМА ЗАМЕЩЕНИЯ ТЕЛА ПОЗВОНКА VBR
CHARSPINE2 MIS PRĘT TWARDY 609.77 CHARSPINE2 MIS Hard rod 6 CHARSPINE2 MIS СТЕРЖЕНЬ ТВЕРДЫЙ 6	INSTRUMENTARIUM SYSTEM IMPLANTÓW SIATKOWYCH VBR09.112 INSTRUMENT SET FOR VBR MESH IMPLANTS ИНСТРУМЕНТЫ-СИСТЕМА ИМПЛАТОВ СЕТЧАТЫХ VBR
CHARSPINE2 MIS PRĘT ZAKRZYWIONY TWARDY 609.78 CHARSPINE2 MIS CURVED HARD ROD 6 CHARSPINE2 MIS СТЕРЖЕНЬ ИЗОГНУТЫЙ ТВЕРДЫЙ 6	INSTRUMENTARIUM SYSTEM IMPLANTÓW SIATKOWYCH VBR09.113 INSTRUMENT SET FOR VBR MESH IMPLANTS ИНСТРУМЕНТЫ-СИСТЕМА ИМПЛАТОВ СЕТЧАТЫХ VBR
CHARSPINE2 MIS PRĘT ZAKRZYWIONY 609.78 CHARSPINE2 MIS CURVED ROD 6 CHARSPINE2 MIS СТЕРЖЕНЬ ИЗОГНУТЫЙ 6	BEZPOŚREDNIA DEROTACJA KRĘGÓW CHARSPINE2 VD09.114 CHARSPINE2 VD DIRECT VERTEBRAL BODY DEROTATION ПРЯМАЯ ДЕРОТАЦИЯ ПОЗВОНКОВ CHARSPINE2 VD
PALETY NA IMPLANTY09.79 PALETTES FOR IMPLANTS ПОДДОНЫ ДЛЯ ИМПЛАТОВ	INSTRUMENTARIUM DO TYLNEJ PREPARACJI KRĘGOSŁUPA ŁĘDŹWIOWEGO 15.0903.00109.115 INSTRUMENT SET FOR POSTERIOR LUMBAR SPINE PREPARATION 15.0903.001 ИНСТР.Д/ЗАДНЕЙ ПОДГОТ.ПОЯСНИЧНОГО ОТДЕЛА ПОЗВОНОЧ. 15.0903.001
INSTRUMENTARIUM CHARSPINE2 MIS PODSTAWOWE09.80 CHARSPINE2 MIS INSTRUMENT SET - BASIC CHARSPINE2 MIS ИНСТРУМЕНТЫ ОСНОВНЫЕ	INDEKS09.120 INDEX ИНДЕКС
INSTRUMENTARIUM CHARSPINE2 MIS DODATKOWE 109.84 CHARSPINE2 MIS INSTRUMENT SET - ADDITIONAL 1 CHARSPINE2 MIS ИНСТРУМЕНТЫ ДОПОЛНИТЕЛЬНЫЕ 1	
KONTENERY NA INSTRUMENTARIUM PODSTAWOWE [15.0913.101] I INSTRUMENTARIUM DODATKOWE [15.0913.202]09.86 CONTAINERS FOR BASIC INSTRUMENT SET [15.0913.101] AND ADDITIONAL INSTRUMENTS [15.0913.202] КОНТЕЙНЕРЫ ДЛЯ ОСНОВНОГО НАБОРА ИНСТРУМЕНТОВ [15.0913.101] И ИНСТРУМЕНТОВ ДОПОЛНИТЕЛЬНЫХ [15.0913.202]	

**ODCINEK ŁĘDŹWIOWY
LUMBAR SEGMENT
ПОЯСНИЧНЫЙ ОТДЕЛ09.87**

PLIF PEEK CAGE, KLATKA MIĘDZYKRĘGOWA09.87 PLIF PEEK CAGE, INTERVERTEBRAL CAGE PLIF PEEK CAGE, МЕЖПОЗВОНОЧНЫЙ КЕЙДЖ
3D-Ti PLIF KLATKA MIĘDZYKRĘGOWA09.88 3D-Ti PLIF INTERVERTEBRAL CAGE 3D-Ti PLIF МЕЖПОЗВОНОЧНЫЙ КЕЙДЖ
INSTRUM.DO KLATEK MIĘDZYKRĘGOWYCH PLIF PEEK CAGE09.91 INSTRUMENT SET FOR PLIF PEEK CAGES ИНСТРУМЕНТЫ Д/МЕЖПОЗВОНОЧНЫХ КЕЙДЖИ PLIF PEEK CAGE
INSTRUM.DO KLATEK MIĘDZYKRĘGOWYCH PLIF PEEK CAGE (ROZSZERZENIE) ...09.93 INSTRUMENT SET FOR PLIF PEEK CAGES (EXTENDED) ИНСТРУМЕНТЫ Д/МЕЖПОЗВОНОЧНЫХ КЕЙДЖИ PLIF PEEK CAGE (РАСШИРЕННЫЕ)
TLIF PEEK KLATKA MIĘDZYKRĘGOWA09.95 TLIF PEEK INTERVERTEBRAL CAGE TLIF PEEK МЕЖПОЗВОНОЧНЫЙ КЕЙДЖ
3D-Ti TLIF KLATKA MIĘDZYKRĘGOWA09.96 3D-Ti TLIF INTERVERTEBRAL CAGE 3D-Ti TLIF КЕЙДЖ МЕЖПОЗВОНОЧНЫЙ

The manufacturer reserves the right to structural changes.

Review: 27.09.2024

	Stop tytanu Titanium alloy Сплав титана		Zakres długości zalecany przy użyciu z daną płytką Recommended length range for a particular plate Диапазон длин рекомендуемый для использования с определенной пластиной
	Stop kobaltu Cobalt alloy Сплав кобальта		Długość A [mm] A length [mm] Длина A [мм]
	PEEK PEEK PEEK		Długość H [mm] H length [mm] Длина H [мм]
	Lewy Left Левый		Kąt Angle Угол
	Prawy Right Правый		Rozmiar Size Размер
	Dostępne w wersji lewy/prawy Available versions: left/right Доступные варианты: левый/правый		Dostępne długości Available lengths Доступные длины
	Długość [mm] Length [mm] Длина [мм]		Dostępna liczba otworów Available number of holes Доступное количество отверстий
	Gniazdo torx Torx drive Шлиц торкс		Grubość [mm] Thickness [mm] Толщина [мм]
	Gniazdo torx kaniulowane Torx drive cannulated Шлиц торкс канюлированный		Skala 1:1 Scale 1:1 Масштаб 1:1
	Gniazdo sześciokątne Hexagonal drive Шлиц шестигранный		Liczba otworów gwintowanych w części trzonowej płytki Number of threaded holes in the shaft part of the plate Количество резьбовых отверстий в диафизарной части пластины
	Gniazdo sześciokątne kaniulowane Hexagonal drive cannulated Шлиц шестигранный канюлированный		Łączna liczba otworów blokowanych w płycie Number of locking holes in the plate Количество блокирующих отверстий в пластине
	Kaniulowany Cannulated Канюлированный		Zmienny kątowno Variable angle Переменный угол
	Blokowany Locking Блокирующий		Korowy Cortical Кортикальный
	Samogwintujący Self-tapping Самонарезающий		Gąbczasty Cancellous Спонгиозный
	Samowierzący Self-drilling Самосверлящий		Dostępny w wersji sterylnej/ niesterylnej Available in sterile/ non-sterile condition Доступный вариант стерильный/ нестерильный
	Średnica [mm] Diameter [mm] Диаметр [мм]		Dostępny w wersji sterylnej Available in sterile condition Доступный вариант стерильный
	Średnica d [mm] d Diameter [mm] Диаметр d [мм]		Patrz technika operacyjna See surgery technique Смотри операционную технику
	Średnica D [mm] D Diameter [mm] Диаметр D [мм]		

Symbole opisujące implant
Symbols describing the implant
Иконки описывающие имплантат

ChM®

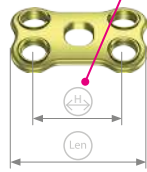

PLYTKA SZYJNA BLOKOWANA
CERVICAL LOCKING PLATE
ПЛАСТИНА ШЕЙНАЯ БЛОКИР.

CHARSPINE system

Len	H ₂	Ti
23	14	3.3133.614
25	16	3.3133.616
28	18	3.3133.618
30	20	3.3133.620
32	22	3.3133.622
34	24	3.3133.624
36	26	3.3133.626
38	28	3.3133.628
45	35	3.3133.635

Nr katalogowy
Catalogue no.
№ по кат.

PLYTKI SZYJNE BLOKOWANE/ CERVICAL LOCKING PLATES/
ШЕЙНЫЕ ПЛАСТИНЫ

	Ti	Len			VA	
	3.3201.012	12				
	3.3201.014	14				
	3.3201.016	16	✓		✓	4.0
	3.3201.018	18				
	3.3995.012	12				
	3.3995.014	14				
	3.3995.016	16		✓	✓	4.0
	3.3995.018	18				
	3.3202.012	12				
	3.3202.014	14	✓		✓	4.5
	3.3202.016	16				
	3.3202.018	18				
	3.3997.012	12				
	3.3997.014	14				
	3.3997.016	16		✓	✓	4.5
	3.3997.018	18				
	3.3998.012	12				
	3.3998.014	14	✓			4.0
	3.3998.016	16				
	3.3998.018	18				
	3.3994.012	12				
	3.3994.014	14				
	3.3994.016	16		✓		4.0
	3.3994.018	18				
	3.3999.012	12				
	3.3999.014	14	✓			4.5
	3.3999.016	16				
	3.3999.018	18				
	3.3996.012	12				
	3.3996.014	14				
	3.3996.016	16		✓		4.5
	3.3996.018	18				



STATYW DO PLYTEK SZYJNYCH - ZESTAW
STAND FOR CERVICAL PLATES - SET
ПОДСТАВКА ДЛЯ ШЕЙНЫХ ПЛАСТИН - НАБОР

40.4865.000

Rozmiary gabarytowe [mm] / Overall dimensions [mm] / Габаритные размеры [мм]

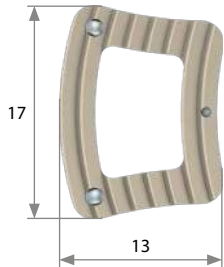

17x13

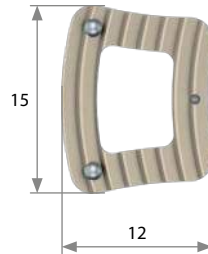

15x12

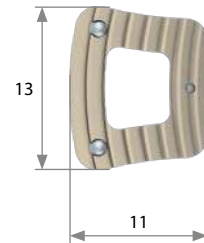

13x11

Rozmiary wysokościowe [mm] / Height sizes [mm] / Размеры высоты H [мм]



4

5

6

7

8

9

10

Odmiany / Variants / Варианты



Kątowa
Angular
Угловая

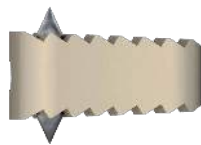

Kątowa z kolcami
Angular with spikes
Угловая с шипами

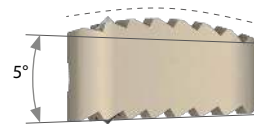

Wypukła
Convex
Выпуклая

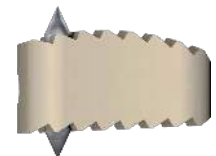

Wypukła z kolcami
Convex with spikes
Выпуклая с шипами

Material/ Material/ Материал



Peek

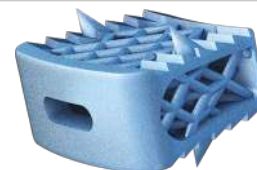

Ti



Klatka międzykręgowa szyjna kątowa
Кейдж межпозвоночный шейный угловой
Angular cervical intervertebral cage

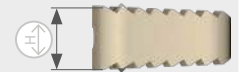

Rozmiar [mm] Size [mm] Размер [mm]					
17x13		15x12		13x11	
Peek	H	Peek	H	Peek	H
8.4558.004	4	8.4554.004	4	8.4556.004	4
8.4558.005	5	8.4554.005	5	8.4556.005	5
8.4558.006	6	8.4554.006	6	8.4556.006	6
8.4558.007	7	8.4554.007	7	8.4556.007	7
8.4558.008	8	8.4554.008	8	8.4556.008	8
8.4558.009	9	8.4554.009	9	8.4556.009	9
8.4558.010	10	8.4554.010	10	8.4556.010	10

Klatka międzykręgowa szyjna kątowa (z kolcami)
Кейдж межпозвоночный шейный угловой (с колючками)
Angular cervical intervertebral cage (with spikes)

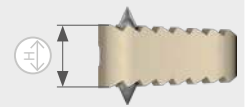

Rozmiar [mm] Size [mm] Размер [mm]					
17x13		15x12		13x11	
Peek	H	Peek	H	Peek	H
8.4584.004	4	8.4582.004	4	8.4580.004	4
8.4584.005	5	8.4582.005	5	8.4580.005	5
8.4584.006	6	8.4582.006	6	8.4580.006	6
8.4584.007	7	8.4582.007	7	8.4580.007	7
8.4584.008	8	8.4582.008	8	8.4580.008	8
8.4584.009	9	8.4582.009	9	8.4580.009	9
8.4584.010	10	8.4582.010	10	8.4580.010	10

Klatka międzykręgowa szyjna wypukła
Кейдж межпозвоночный шейный выпуклый
Convex cervical intervertebral cage

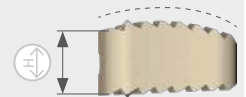

Rozmiar [mm] Size [mm] Размер [mm]					
17x13		15x12		13x11	
Peek	H	Peek	H	Peek	H
8.4559.004	4	8.4555.004	4	8.4557.004	4
8.4559.005	5	8.4555.005	5	8.4557.005	5
8.4559.006	6	8.4555.006	6	8.4557.006	6
8.4559.007	7	8.4555.007	7	8.4557.007	7
8.4559.008	8	8.4555.008	8	8.4557.008	8
8.4559.009	9	8.4555.009	9	8.4557.009	9
8.4559.010	10	8.4555.010	10	8.4557.010	10

Klatka międzykręgowa szyjna wypukła (z kolcami)
Convex cervical intervertebral cage (with spikes)
Кейдж межпозвоночный шейный выпуклый (с колючками)

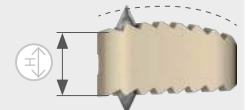

Rozmiar [mm] Size [mm] Размер [mm]					
17x13		15x12		13x11	
Peek	H	Peek	H	Peek	H
8.4585.004	4	8.4583.004	4	8.4581.004	4
8.4585.005	5	8.4583.005	5	8.4581.005	5
8.4585.006	6	8.4583.006	6	8.4581.006	6
8.4585.007	7	8.4583.007	7	8.4581.007	7
8.4585.008	8	8.4583.008	8	8.4581.008	8
8.4585.009	9	8.4583.009	9	8.4581.009	9
8.4585.010	10	8.4583.010	10	8.4581.010	10

Ster

CHARSPINE system 2

3D-Ti Klatka międzykręgowa szyjna kątowa
3D-Ti Angular cervical intervertebral cage
3D-Ti Кейдж межпозвоночный шейный угловой



Rozmiar [mm] Size [mm] Размер [мм]								
17x13			15x12			13x11		
1:1	Ti	H	1:1	Ti	H	1:1	Ti	H
	3.6937.004S	4		3.6936.004S	4		3.6935.004S	4
	3.6937.005S	5		3.6936.005S	5		3.6935.005S	5
	3.6937.006S	6		3.6936.006S	6		3.6935.006S	6
	3.6937.007S	7		3.6936.007S	7		3.6935.007S	7
	3.6937.008S	8		3.6936.008S	8		3.6935.008S	8
	3.6937.009S	9		3.6936.009S	9		3.6935.009S	9
	3.6937.010S	10		3.6936.010S	10		3.6935.010S	10

3D-Ti Klatka międzykręgowa szyjna kątowa (z kolcami)
3D-Ti Angular cervical intervertebral cage (with spikes)
3D-Ti Кейдж межпозвоночный шейный угловой (с колючками)



Rozmiar [mm] Size [mm] Размер [мм]								
17x13			15x12			13x11		
1:1	Ti	H	1:1	Ti	H	1:1	Ti	H
	3.6940.004S	4		3.6939.004S	4		3.6938.004S	4
	3.6940.005S	5		3.6939.005S	5		3.6938.005S	5
	3.6940.006S	6		3.6939.006S	6		3.6938.006S	6
	3.6940.007S	7		3.6939.007S	7		3.6938.007S	7
	3.6940.008S	8		3.6939.008S	8		3.6938.008S	8
	3.6940.009S	9		3.6939.009S	9		3.6938.009S	9
	3.6940.010S	10		3.6939.010S	10		3.6938.010S	10

3D-Ti Klatka międzykręgowa szyjna wypukła
3D-Ti Convex cervical intervertebral cage
3D-Ti Кейдж межпозвоночный шейный выпуклый

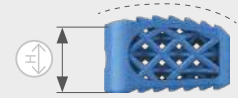







Rozmiar [mm] Size [mm] Размер [мм]								
17x13			15x12			13x11		
1:1	Ti	H	1:1	Ti	H	1:1	Ti	H
	3.6943.004S	4		3.6942.004S	4		3.6941.004S	4
	3.6943.005S	5		3.6942.005S	5		3.6941.005S	5
	3.6943.006S	6		3.6942.006S	6		3.6941.006S	6
	3.6943.007S	7		3.6942.007S	7		3.6941.007S	7
	3.6943.008S	8		3.6942.008S	8		3.6941.008S	8
	3.6943.009S	9		3.6942.009S	9		3.6941.009S	9
	3.6943.010S	10		3.6942.010S	10		3.6941.010S	10

3D-Ti Klatka międzykręgowa szyjna wypukła (z kolcami)
Convex cervical intervertebral cage (with spikes)
Кейдж межпозвоночный шейный выпуклый (с колючками)



Rozmiar [mm] Size [mm] Размер [мм]								
17x13			15x12			13x11		
1:1	Ti	H	1:1	Ti	H	1:1	Ti	H
	3.6946.004S	4		3.6945.004S	4		3.6944.004S	4
	3.6946.005S	5		3.6945.005S	5		3.6944.005S	5
	3.6946.006S	6		3.6945.006S	6		3.6944.006S	6
	3.6946.007S	7		3.6945.007S	7		3.6944.007S	7
	3.6946.008S	8		3.6945.008S	8		3.6944.008S	8
	3.6946.009S	9		3.6945.009S	9		3.6944.009S	9
	3.6946.010S	10		3.6945.010S	10		3.6944.010S	10

15.0902.002	Zestaw - klatki międzykręgowe szyjne Set - cervical intervertebral cages Набор - межпозвоночные шейные кейджи	Nr katalogowy Catalogue no. № по кат.
	Pokrywa - Klatki międzykręgowe szyjne 9x4 Lid - Cervical intervertebral cages 9x4 Покрышка для инструментов -Межпозвоночные шейные кейджи 9x4	14.0902.102
	Instrumentarium - Klatki międzykręgowe szyjne Instrument set - Cervical intervertebral cages Инструменты - Межпозвоночные шейные кейджи	15.0902.202
	Instrumentarium - Klatki międzykręgowe szyjne Instrument set - Cervical intervertebral cages Инструменты - Межпозвоночные шейные кейджи	15.0902.203
	Instrumentarium - Klatki międzykręgowe szyjne Instrument set - Cervical intervertebral cages Инструменты - Межпозвоночные шейные кейджи	15.0902.204
	Instrumentarium - Klatki międzykręgowe szyjne Instrument set - Cervical intervertebral cages Инструменты - Межпозвоночные шейные кейджи	15.0902.201
	Kontener - Klatki międzykręgowe szyjne 9x4 1/2H Container - Cervical intervertebral cages 9x4 1/2H Контейнер - Межпозвоночные шейные кейджи 9x4 1/2H	14.0902.101

15.0902.201 Instrumentarium - klatki międzykręgowe szyjne
 Instrument set - cervical intervertebral cages
 Инструменты - межпозвоночные шейные кейджи

Nr katalogowy
 Catalogue No.
 № по каталогу

Szt.
 Pcs
 Шт.



Paleta na instrumentarium - Klatki międzykr. szyjne 5x4 1/2H
 Tray for instrument set - Cervical intervertebral cages 5x4 1/2H
 Поддон для инструментов - Межпозвоночные шейные кейджи 5x4 1/2H

14.0902.201 1

	Aplikator Applicator Аппликатор	40.6078.000	1
	Manipulator Persuader Манипулятор	40.6080.000	1
	Wkrętak do grotów Caspara Screwdriver for Caspar pins Отвертка для наконечников Caspara	40.6086.000	1
	Ubijak Compressor Пробойник	40.6077.000	1
	Młotek 200g Hammer 200g Молоток 200г	40.6087.000	1
	Stolik roboczy Working stand Подставка рабочая	40.6085.000	1
	Ustalacz położenia Position retainer Стопор позиции	40.6079.000	1
	Dystraktor szyjny Caspara Caspar cervical distractor Дистрактор шейный Caspara	40.6075.000	1
	Grot Caspara 3,0x14 Caspar pin 3.0x14 Наконечник Caspara 3,0x14	40.6076.014	2
	Grot Caspara 3,0x16 Caspar pin 3.0x16 Наконечник Caspara 3,0x16	40.6076.016	2

15.0902.202	Instrumentarium - klatki międzykręgowie szyjne Instrument set - cervical intervertebral cages Инструменты - межпозвоночные шейные кейджи	Nr katalogowy Catalogue No. № по каталогу	Szt. Pcs Шт.
	Statyw na instrumentarium - Klatki międzykręgowie szyjne 4x2 1/2H Stand for instrument set - Cervical intervertebral cages 4x2 1/2H Подставка для инструментов - Межпозвоночные шейные кейджи 4x2 1/2H	14.0902.203	1
	Raszpla Bone rasp Рашпиль	4x13x11 5x13x11 6x13x11 7x13x11 8x13x11 9x13x11 10x13x11	40.6088.004 40.6088.005 40.6088.006 40.6088.007 40.6088.008 40.6088.009 40.6088.010
	Przymiar kątowy Angular trial Мера угловая	4x13x11 5x13x11 6x13x11 7x13x11 8x13x11 9x13x11 10x13x11	40.6090.004 40.6090.005 40.6090.006 40.6090.007 40.6090.008 40.6090.009 40.6090.010
	Przymiar wypukły Convex trial Мера выпуклая	4x13x11 5x13x11 6x13x11 7x13x11 8x13x11 9x13x11 10x13x11	40.6089.004 40.6089.005 40.6089.006 40.6089.007 40.6089.008 40.6089.009 40.6089.010
15.0902.203	Instrumentarium - klatki międzykręgowie szyjne Instrument set - cervical intervertebral cages Инструменты - межпозвоночные шейные кейджи	Nr katalogowy Catalogue No. № по каталогу	Szt. Pcs Шт.
	Statyw na instrumentarium - Klatki międzykręgowie szyjne 4x2 1/2H Stand for instrument set - Cervical intervertebral cages 4x2 1/2H Подставка для инструментов - Межпозвоночные шейные кейджи 4x2 1/2H	14.0902.202	1
	Raszpla Bone rasp Рашпиль	4x15x12 5x15x12 6x15x12 7x15x12 8x15x12 9x15x12 10x15x12	40.6081.004 40.6081.005 40.6081.006 40.6081.007 40.6081.008 40.6081.009 40.6081.010
	Przymiar kątowy Angular trial Мера угловая	4x15x12 5x15x12 6x15x12 7x15x12 8x15x12 9x15x12 10x15x12	40.6083.004 40.6083.005 40.6083.006 40.6083.007 40.6083.008 40.6083.009 40.6083.010
	Przymiar wypukły Convex trial Мера выпуклая	4x15x12 5x15x12 6x15x12 7x15x12 8x15x12 9x15x12 10x15x12	40.6082.004 40.6082.005 40.6082.006 40.6082.007 40.6082.008 40.6082.009 40.6082.010

15.0902.204 Instrumentarium - klatki międzykręgowie szyjne
 Instrument set - cervical intervertebral cages
 Инструменты-межпозвоночные шейные кейджи

Nr katalogowy Szt.
 Catalogue No. Pcs
 № по каталогу Шт.



Statyw na instrumentarium - Klatki międzykręgowie szyjne 4x2
 1/2H

Stand for instrument set - Cervical intervertebral cages 4x2 1/2H
 Подставка для инструментов - Межпозвоночные шейные кейджи 4x2 1/2H

14.0902.204 1



Raszpla
 Bone rasp
 Рашпиль

4x17x13	40.6091.004	1
5x17x13	40.6091.005	1
6x17x13	40.6091.006	1
7x17x13	40.6091.007	1
8x17x13	40.6091.008	1
9x17x13	40.6091.009	1
10x17x13	40.6091.010	1



Przymiar kątowy
 Мера угловая
 Angular trial

4x17x13	40.6093.004	1
5x17x13	40.6093.005	1
6x17x13	40.6093.006	1
7x17x13	40.6093.007	1
8x17x13	40.6093.008	1
9x17x13	40.6093.009	1
10x17x13	40.6093.010	1



Przymiar wypukły
 Мера выпуклая
 Convex trial

4x17x13	40.6092.004	1
5x17x13	40.6092.005	1
6x17x13	40.6092.006	1
7x17x13	40.6092.007	1
8x17x13	40.6092.008	1
9x17x13	40.6092.009	1
10x17x13	40.6092.010	1



Rozmiary gabarytowe Overall dimensions Габаритные размер [mmmm]

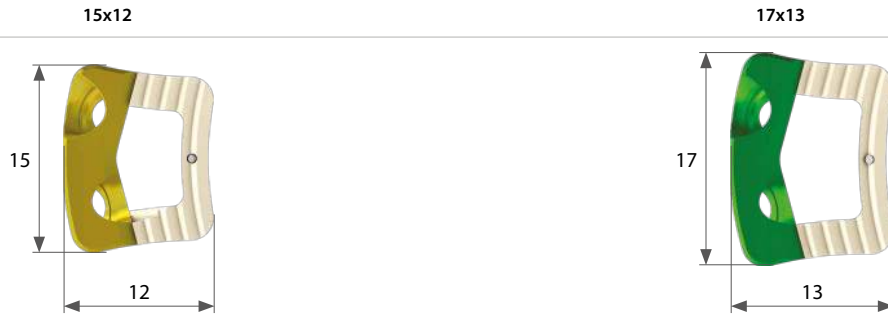

Rozmiary wysokościowe Height sizes Размеры высоты H [mmmm]



Odmiany Variants Варианты

Klatka międzykręgowa szyjna kątowa
 Angular cervical intervertebral cage
 Кейдж межпозвоночный шейный угловой

Klatka międzykręgowa szyjna wypukła
 Convex cervical intervertebral cage
 Кейдж межпозвоночный шейный выпуклый

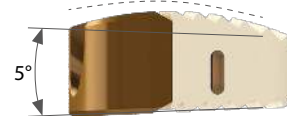

Klatka międzykręgowa szyjna kątowa /Angular cervical intervertebral cage/ Кейдж межпозвоночный шейный угловой



Rozmiar Size Размер 15x12 [mmmm]

Rozmiar Size Размер 17x13 [mmmm]

Nr katalogowy Catalogue no. № по каталогу	Wysokość [mm] Height H [mm] Высота [мм]	Nr katalogowy Catalogue no. № по каталогу	Wysokość [mm] Height H [mm] Высота [мм]
8.6970.505	5	8.6971.505	5
8.6970.506	6	8.6971.506	6
8.6970.507	7	8.6971.507	7
8.6970.508	8	8.6971.508	8
8.6970.509	9	8.6971.509	9
8.6970.510	10	8.6971.510	10

Klatka międzykręgowa szyjna wypukła/ Кейдж межпозвоночный шейный выпуклый/ Convex cervical intervertebral cage



Rozmiar Size Размер 15x12 [mmmm]

Rozmiar Size Размер 17x13 [mmmm]

Nr katalogowy Catalogue no. № по каталогу	Wysokość [mm] Height H [mm] Высота [мм]	Nr katalogowy Catalogue no. № по каталогу	Wysokość [mm] Height H [mm] Высота [мм]
8.6972.005	5	8.6973.005	5
8.6972.006	6	8.6973.006	6
8.6972.007	7	8.6973.007	7
8.6972.008	8	8.6973.008	8
8.6972.009	9	8.6973.009	9
8.6972.010	10	8.6973.010	10

Ster

Rozmiary gabarytowe Overall dimensions Габаритные размеры [mmmm]

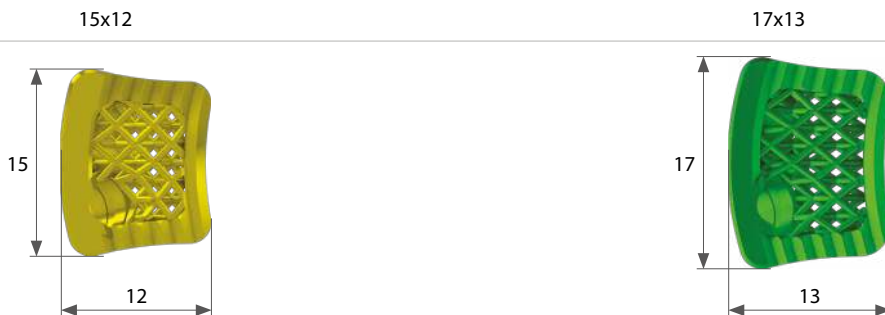

Rozmiary wysokościowe Height sizes Размеры высоты H [mmmm]



Odmiany Variants Варианты

Klatka międzykręgową szyjną kątową Кейдж межпозвоночный шейный угловой Angular cervical intervertebral cage

Klatka międzykręgową szyjną wypukłą Кейдж межпозвоночный шейный выпуклый Convex cervical intervertebral cage



Klatka międzykręgową szyjną kątową Кейдж межпозвоночный шейный угловой Angular cervical intervertebral cage



Ster

Rozmiar Size Размер 15x12 [mmmm]

Rozmiar Size Размер 17x13 [mmmm]

Nr katalogowy Catalogue no. № по каталогу	Wysokość [mm] Height H [mm] Высота [мм]	Nr katalogowy Catalogue no. № по каталогу	Wysokość [mm] Height H [mm] Высота [мм]
3.6986.005S	5	3.6987.005S	5
3.6986.006S	6	3.6987.006S	6
3.6986.007S	7	3.6987.007S	7
3.6986.008S	8	3.6987.008S	8
3.6986.009S	9	3.6987.009S	9
3.6986.010S	10	3.6987.010S	10

Klatka międzykręgową szyjną wypukłą Кейдж межпозвоночный шейный выпуклый Convex cervical intervertebral cage



Ster

Rozmiar Size Размер 15x12 [mmmm]

Rozmiar Size Размер 17x13 [mmmm]

Nr katalogowy Catalogue no. № по каталогу	Wysokość [mm] Height H [mm] Высота [мм]	Nr katalogowy Catalogue no. № по каталогу	Wysokość [mm] Height H [mm] Высота [мм]
3.6988.005S	5	3.6989.005S	5
3.6988.006S	6	3.6989.006S	6
3.6988.007S	7	3.6989.007S	7
3.6988.008S	8	3.6989.008S	8
3.6988.009S	9	3.6989.009S	9
3.6988.010S	10	3.6989.010S	10



Wkręt szyjny blokujący 3,5 samowiercący
Cervical locking screw 3.5 (self-drilling)
Винт шейный блокирующий 3,5 самосверлящий



Średnica Diameter Диаметр	Długość [mm] Length [mm] Длина [мм]	Kolor Colour Цвет	Nr katalogowy Catalogue no. № по каталогу
3.5	10		3.6974.010
3.5	12		3.6974.012
3.5	14		3.6974.014
3.5	16		3.6974.016

Wkręt szyjny blokujący 4,0 samowiercący
Cervical locking screw 4.0 (self-drilling)
Винт шейный блокирующий 4,0 самосверлящий



Średnica Diameter Диаметр	Długość [mm] Length [mm] Длина [мм]	Kolor Colour Цвет	Nr katalogowy Catalogue no. № по каталогу
4	10		3.6975.010
4	12		3.6975.012
4	14		3.6975.014
4	16		3.6975.016

Material Material Материал: Ti

Statyw na implanty-zestaw
 Stand for implants - set
 Подставка для имплантатов - набор

Nr katalogowy
 Catalogue No.
 № по каталогу



Pokrywa kontenera
 Container lid 4x4
 Покрышка для контейнера 4x4

14.0917.103



Statyw na implanty-Klatki międzykręgowie 4x2 1/2H
 Stand for implants - Cervical intervertebral cages 4x2 1/2H
 Подставка д/импл.-межпозв.шейные кейджи 4x2 1/2H

14.0917.401



Statyw na implanty-Klatki międzykręgowie 4x2 1/2H
 Stand for implants - Cervical intervertebral cages 4x2 1/2H
 Подставка д/импл.-межпозв.шейные кейджи 4x2 1/2H

14.0917.501



Kontener 4x4
 Container 4x4H
 Контейнер 4x4H

14.0000.003

Puszka sterylizacyjna (do statywu na implanty - zestaw)
 Контейнер для стерилизации (для подставки для имплантатов)
 Sterilization container (for the stand for implants - set)

Nr katalogowy
 Catalogue No.
 № по каталогу















Pokrywa aluminiowa perfor. 1/2 306x272x15mm szara
 Perforated aluminum lid 1/2 306x272x15mm Gray
 Покрышка алюм.перфорир. 1/2 306x272x15мм Серая

12.0751.200







Kontener z litym dnem 1/2 306x272x85mm Container
 with solid bottom 1/2 306x272x85mm Контейнер со
 сплошным дном 1/2 306x272x85мм

12.0751.100

15.0917.102	Instrumentarium do klatek międzykręgowych szyjnych blokowanych Instrument set for cervical intervertebral locking cages Инструменты д/межпозвоночных шейных блок.Кейджей	Nr katalogowy Catalogue No. № по каталогу	Szt. Pcs Шт.
	Pokrywa kontenera 9x4 Покрышка для контейнера 9x4 Container lid 9x4	14.0917.105	1
	Aplikator Апликатор Applicator	40.8784.000	1
	Manipulator Манипулятор Persuader	40.6080.000	1
	Ubijak Пробойник Comractor	40.6077.000	1
	Młotek 200g Молоток 200g Hammer 200g	40.6087.000	1
	Statyw roboczy Working stand Подставка рабочая	40.8786.100	1
	Ustalacz położenia Стопор позиции Position retainer	40.6079.100	1
H-5		40.8785.105	1
H-6		40.8785.106	1
H-7	Nakładka celująca Aiming block	40.8785.107	1
H-8	Шаблон накладка	40.8785.108	1
H-9		40.8785.109	1
H-10		40.8785.110	1
	Trokar Trocar Троакаp	40.8780.100	1
	Trokar Trocar Троакаp	40.8781.100	1
	Grot T10 Screwdriver tip T10 Наконечник 10	40.8783.100	1
	Grot przegubowy T10 Screwdriver tip T10 with joint Наконечник шарнирный T10	40.8782.100	1
	Rękojeść ze sprzęgłem Handle ratchet device Рукоятка со сцеплением	40.6654.001	1
	Wykręтак Extractor Экстрактор	40.8789.000	1

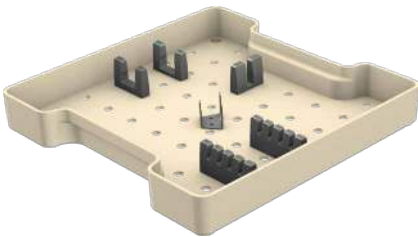
15.0917.102	Instrumentarium do klatek międzykręgowych szyjnych blokowanych Instrument set for cervical intervertebral locking cages Инструменты д/межпозвоночных шейных блок.Кейджей	Nr katalogowy Catalogue No. № по каталогу	Szt. Pcs Шт.
	Statyw 9x4 Stand 9x4 Подставка 9x4	14.0917.201	1
	Przymiar kątowy Мера угловая Angular trial	5x15x12 40.6083.005 6x15x12 40.6083.006 7x15x12 40.6083.007 8x15x12 40.6083.008 9x15x12 40.6083.009 10x15x12 40.6083.010	1 1 1 1 1 1
	Przymiar wypukły Мера выпуклая Convex trial	5x15x12 40.6082.005 6x15x12 40.6082.006 7x15x12 40.6082.007 8x15x12 40.6082.008 9x15x12 40.6082.009 10x15x12 40.6082.010	1 1 1 1 1 1
	Przymiar kątowy Мера угловая Angular trial	5x17x13 40.6093.005 6x17x13 40.6093.006 7x17x13 40.6093.007 8x17x13 40.6093.008 9x17x13 40.6093.009 10x17x13 40.6093.010	1 1 1 1 1 1
	Przymiar wypukły Мера выпуклая Convex trial	5x17x13 40.6092.005 6x17x13 40.6092.006 7x17x13 40.6092.007 8x17x13 40.6092.008 9x17x13 40.6092.009 10x17x13 40.6092.010	1 1 1 1 1 1
	Kontener 9x4 1/2H Container 9x4 1/2H Контейнер 9x4 1/2H	14.0917.104	1
Puszka sterylizacyjna (do Instrumentarium do klatek międzykr. szyjnych blokowanych) Контейнер для стерилизации (для Инструменты д/межпозвоночных шейных блок.кейджей) Sterilization container (for the Instrument set for cervical intervertebral locking cages)		Nr katalogowy Catalogue No. № по каталогу	Szt. Pcs Шт.
	Pokrywa aluminiowa perfor.1/1 595x275x15mm Szara Perforated aluminum lid 1/1 595x275x15mm Gray Покрышка алюм.перфорир.1/1 595x275x15мм Серая	12.0750.200	1
	Kontener z litym dnem 1/1 595x275x86mm Container with solid bottom 1/1 595x275x86mm Контейнер со сплошным дном 1/1 595x275x86мм	12.0750.100	1

Narzędzia ponadstandardowe Supplementary instruments Дополнительные инструменты		Nr katalogowy Catalogue no. № по кат.	Szt. Pcs Шт.
15.0918.220	Instrumentarium Dystraktor szyjny Caspara Instrument set for Caspar cervical distractor Инструменты дистрактор шейный Caspara		
	Dystraktor szyjny Caspara Caspar cervical distractor Дистрактор шейный Caspara	40.6075.000	1
	Wkrętak do grotów Caspara Screwdriver for Caspar pins Отвертка для наконечников Caspara	40.6086.000	1
	Grot Caspara 3,0x14 Caspar pin 3.0x14 Наконечник Caspara 3,0x14	40.6076.014	2
	Grot Caspara 3,0x16 Caspar pin 3.0x16 Наконечник Caspara 3,0x16	40.6076.016	2
	Paleta 4x4 1/2H Tray 4x4 1/2H Поддон 4x4 1/2H	14.0918.220	1
Kontener z pokrywą (do zestawu do dystrakcji) Container with lid (for the distraction set) Контейнер с крышкой (для набора для дистракции)		Nr katalogowy Catalogue no. № по кат.	Szt. Pcs Шт.
	Pokrywa kontenera 4x4 Покрышка для контейнера 4x4 Container lid 4x4	14.0000.102	1
	Kontener 4x4 1/2H Container 4x4 1/2H Контейнер 4x4 1/2H	14.0000.004	1

Puszka sterylizacyjna (do zestawu do dystrakcji) Sterilization container (for the distraction set) Контейнер для стерилизации (для набора для дистракции)	Nr katalogowy Catalogue no. № по кат.	Szt. Pcs Шт.
---	---	--------------------



Pokrywa aluminiowa perfor. 1/2 306x272x15mm
 szara Perforated aluminum lid 1/2 306x272x15mm
 Gray Покрышка алюм. перфорир. 1/2
 306x272x15мм Серая

12.0751.200 1



Kontener z litym dnem 1/2 306x272x85mm
 Container with solid bottom 1/2 306x272x85mm
 Контейнер со сплошным дном 1/2 306x272x85мм

12.0751.100 1

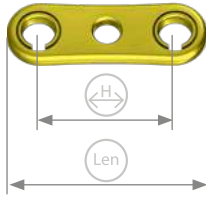







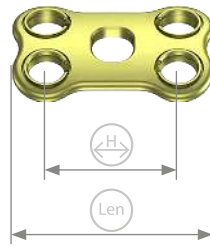

Len	H	Ti
23	14	3.3136.023
25	16	3.3136.025
27	18	3.3136.027
29	18	3.3136.029

	Ti	Len			VA	
	3.3201.012	12				
	3.3201.014	14				
	3.3201.016	16	✓		✓	4.0
	3.3201.018	18				
	3.3995.012	12				
	3.3995.014	14				
	3.3995.016	16		✓	✓	4.0
	3.3995.018	18				
	3.3202.012	12				
	3.3202.014	14				
	3.3202.016	16	✓		✓	4.5
	3.3202.018	18				
	3.3997.012	12				
	3.3997.014	14				
	3.3997.016	16		✓	✓	4.5
	3.3997.018	18				
	3.3998.012	12				
	3.3998.014	14				
	3.3998.016	16	✓			4.0
	3.3998.018	18				
	3.3994.012	12				
	3.3994.014	14				
	3.3994.016	16		✓		4.0
	3.3994.018	18				
	3.3999.012	12				
	3.3999.014	14				
	3.3999.016	16	✓			4.5
	3.3999.018	18				
	3.3996.012	12				
	3.3996.014	14				
	3.3996.016	16		✓		4.5
	3.3996.018	18				





Len	H	Ti
23	14	3.3133.614
25	16	3.3133.616
28	18	3.3133.618
30	20	3.3133.620
32	22	3.3133.622
34	24	3.3133.624
36	26	3.3133.626
38	28	3.3133.628
45	35	3.3133.635

	Ti	Len			VA	
	3.3201.012	12				
	3.3201.014	14				
	3.3201.016	16	✓		✓	4.0
	3.3201.018	18				
	3.3995.012	12				
	3.3995.014	14				
	3.3995.016	16		✓	✓	4.0
	3.3995.018	18				
	3.3202.012	12				
	3.3202.014	14				
	3.3202.016	16	✓		✓	4.5
	3.3202.018	18				
	3.3997.012	12				
	3.3997.014	14				
	3.3997.016	16		✓	✓	4.5
	3.3997.018	18				
	3.3998.012	12				
	3.3998.014	14				
	3.3998.016	16	✓			4.0
	3.3998.018	18				
	3.3994.012	12				
	3.3994.014	14				
	3.3994.016	16		✓		4.0
	3.3994.018	18				
	3.3999.012	12				
	3.3999.014	14				
	3.3999.016	16	✓			4.5
	3.3999.018	18				
	3.3996.012	12				
	3.3996.014	14				
	3.3996.016	16		✓		4.5
	3.3996.018	18				







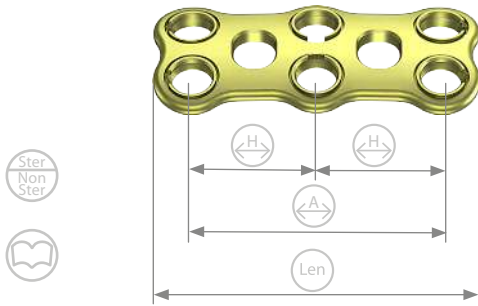



STATYW DO PLYTEK SZYJNYCH - ZESTAW
STAND FOR CERVICAL PLATES - SET
ПОДСТАВКА ДЛЯ ШЕЙНЫХ ПЛАСТИН - НАБОР

40.4865.000



Len	H	A	Ti
37	14	28	3.3133.228
39	15	30	3.3133.230
41	16	32	3.3133.232
43	17	34	3.3133.234
46	18	36	3.3133.236

	Ti	Len	✓	✓	VA	↗
	3.3201.012	12				
	3.3201.014	14				
	3.3201.016	16	✓		✓	4.0
	3.3201.018	18				
	3.3995.012	12				
	3.3995.014	14				
	3.3995.016	16		✓	✓	4.0
	3.3995.018	18				
	3.3202.012	12				
	3.3202.014	14				
	3.3202.016	16	✓		✓	4.5
	3.3202.018	18				
	3.3997.012	12				
	3.3997.014	14				
	3.3997.016	16		✓	✓	4.5
	3.3997.018	18				
	3.3998.012	12				
	3.3998.014	14				
	3.3998.016	16	✓			4.0
	3.3998.018	18				
	3.3994.012	12				
	3.3994.014	14				
	3.3994.016	16		✓		4.0
	3.3994.018	18				
	3.3999.012	12				
	3.3999.014	14				
	3.3999.016	16	✓			4.5
	3.3999.018	18				
	3.3996.012	12				
	3.3996.014	14				
	3.3996.016	16		✓		4.5
	3.3996.018	18				







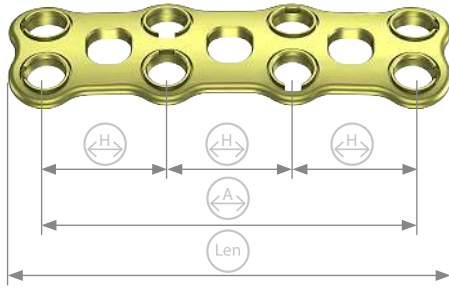



STATYW DO PŁYTEK SZYJNYCH - ZESTAW
STAND FOR CERVICAL PLATES - SET
ПОДСТАВКА ДЛЯ ШЕЙНЫХ ПЛАСТИН - НАБОР

40.4865.000



Len	H	A	Ti
50	14	42	3.3133.342
53	15	45	3.3133.345
56	16	48	3.3133.348
59	17	51	3.3133.351
62	18	54	3.3133.354
65	19	57	3.3133.357

	Ti	Len			VA	
	3.3201.012	12				
	3.3201.014	14				
	3.3201.016	16	✓		✓	4.0
	3.3201.018	18				
	3.3995.012	12				
	3.3995.014	14				
	3.3995.016	16		✓	✓	4.0
	3.3995.018	18				
	3.3202.012	12				
	3.3202.014	14				
	3.3202.016	16	✓		✓	4.5
	3.3202.018	18				
	3.3997.012	12				
	3.3997.014	14				
	3.3997.016	16		✓	✓	4.5
	3.3997.018	18				
	3.3998.012	12				
	3.3998.014	14				
	3.3998.016	16	✓			4.0
	3.3998.018	18				
	3.3994.012	12				
	3.3994.014	14				
	3.3994.016	16		✓		4.0
	3.3994.018	18				
	3.3999.012	12				
	3.3999.014	14				
	3.3999.016	16	✓			4.5
	3.3999.018	18				
	3.3996.012	12				
	3.3996.014	14				
	3.3996.016	16		✓		4.5
	3.3996.018	18				







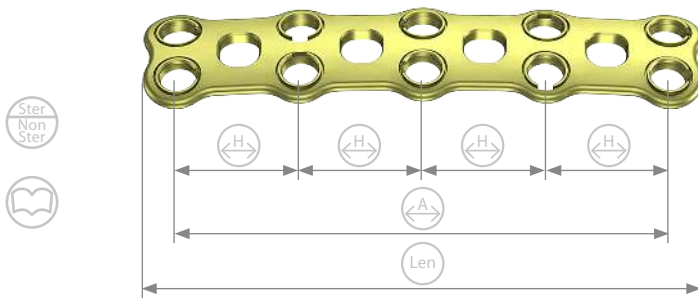



STATYW DO PLYTEK SZYJNYCH - ZESTAW
STAND FOR CERVICAL PLATES - SET
ПОДСТАВКА ДЛЯ ШЕЙНЫХ ПЛАСТИН - НАБОР

40.4865.000



Len	H	A	Ti
69	15	60	3.3133.460
73	16	64	3.3133.464
77	17	68	3.3133.468
81	18	72	3.3133.472
85	19	76	3.3133.476
89	20	80	3.3133.480





	Ti	Len			VA	
	3.3201.012	12				
	3.3201.014	14				
	3.3201.016	16	✓		✓	4.0
	3.3201.018	18				
	3.3995.012	12				
	3.3995.014	14				
	3.3995.016	16		✓	✓	4.0
	3.3995.018	18				
	3.3202.012	12				
	3.3202.014	14				
	3.3202.016	16	✓		✓	4.5
	3.3202.018	18				
	3.3997.012	12				
	3.3997.014	14				
	3.3997.016	16		✓	✓	4.5
	3.3997.018	18				
	3.3998.012	12				
	3.3998.014	14				
	3.3998.016	16	✓			4.0
	3.3998.018	18				
	3.3994.012	12				
	3.3994.014	14				
	3.3994.016	16		✓		4.0
	3.3994.018	18				
	3.3999.012	12				
	3.3999.014	14				
	3.3999.016	16	✓			4.5
	3.3999.018	18				
	3.3996.012	12				
	3.3996.014	14				
	3.3996.016	16		✓		4.5
	3.3996.018	18				



STATYW DO PLYTEK SZYJNYCH - ZESTAW
STAND FOR CERVICAL PLATES - SET
ПОДСТАВКА ДЛЯ ШЕЙНЫХ ПЛАСТИН - НАБОР

40.4865.000

40.4820.700	Instrumentarium do płytek szyjnych Instrument set for cervical plates Инструменты для шейных пластин	Nr katalogowy Catalogue no. № по кат.	Szt. Pcs Шт.
	Trokar C Trocar C Троакар C	40.4821.100	1
	Prowadnica do wiertła C - wielokątna Drill guide C - multiangular Направитель сверла C - многоугольный	40.4825.100	1
	Wkręt pozycjonujący C Positioning screw C Винт позиционированный C	40.4826.225	2
	Wkrętak do wkrętów szyjnych bloko- wanych Screwdriver for locking cervical screws Отвертка для шейных блокирующих винтов	40.4828.100	1
	Wyginak do płytek Plates bender Выгибатель для пластин	40.4830.000	1
	Wiertło z ogranicznikiem C 2,2/12 Drill with limiter C 2.2/12 Сверло с ограничителем C 2,2/12	40.4831.512	1
	Wiertło z ogranicznikiem C 2,2/14 Drill with limiter C 2.2/14 Сверло с ограничителем C 2,2/14	40.4831.514	1
	Wiertło z ogranicznikiem C 2,2/16 Drill with limiter C 2.2/16 Сверло с ограничителем C 2,2/16	40.4831.516	1
	Wiertło z ogranicznikiem C 2,2/18 Drill with limiter C 2.2/18 Сверло с ограничителем C 2,2/18	40.4831.518	1
	Rękojeść ze sprzęgłem Handle ratchet device Рукоятка со сцеплением	40.6654.001	1
	Wkrętak do wkrętów szyjnych lity Screwdriver for cervical screws Отвертка сплошная для шейных винтов	40.5286.500	1

40.4820.700	Instrumentarium do płytek szyjnych Instrument set for cervical plates Инструменты для шейных пластин	Nr katalogowy Catalogue no. № по кат.	Szt. Pcs Шт.
	 <p>Chwytnak do płytek Plate holder Захват для пластин</p>	40.4832.100	1
	 <p>Wzorzec głębokości otw. C Hole depth measure C Измеритель глубины отверстий C</p>	40.4833.100	1
	 <p>Wzorzec rozmiaru płytki Plate size measure Измеритель размера пластины</p>	40.4834.100	1
	 <p>Prowadnica do wiertła C - sztywna Drill guide C - rigid Направитель сверла C - жесткий</p>	40.4836.100	1
	 <p>Statyw do instrument. płytek szyjnych blokowanych Stand for instrument set for cervical locking plates Подставка для инструментов для блокируемых шейных пластин</p>	40.4838.600	1

CHARSPINE OCT ŚRUBA POLIAKSJALNA
 CHARSPINE OCT POLYAXIAL SCREW
 CHARSPINE OCT ВИНТ ПОЛИАКСИАЛЬНЫЙ

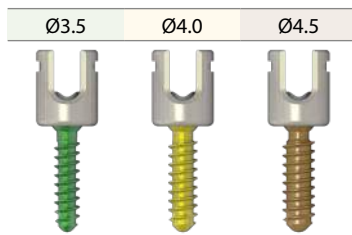
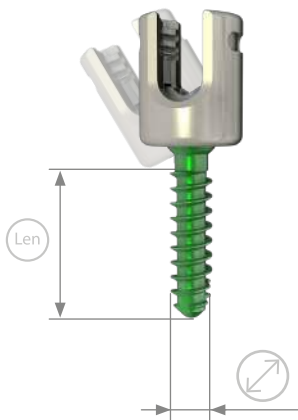

CHARSPINE OCT WKRĘT BLOKUJĄCY
 CHARSPINE OCT LOCKING SCREW
 CHARSPINE OCT ВИНТ ЗАЖИМНОЙ



3.6111.000



	Len	Ti
3.5	10	3.5999.010
	12	3.5999.012
	14	3.5999.014
	16	3.5999.016
	18	3.5999.018
	20	3.5999.020
	22	3.5999.022
	24	3.5999.024
	26	3.5999.026
	28	3.5999.028
	30	3.5999.030
	32	3.5999.032
4.0	34	3.5999.034
	10	3.6100.010
	12	3.6100.012
	14	3.6100.014
	16	3.6100.016
	18	3.6100.018
	20	3.6100.020
	22	3.6100.022
	24	3.6100.024
	26	3.6100.026
	28	3.6100.028
	30	3.6100.030
32	3.6100.032	
34	3.6100.034	
36	3.6100.036	
38	3.6100.038	
40	3.6100.040	
4.5	10	3.6101.010
	12	3.6101.012
	14	3.6101.014
	16	3.6101.016
	18	3.6101.018
	20	3.6101.020
	22	3.6101.022
	24	3.6101.024
	26	3.6101.026
	28	3.6101.028
	30	3.6101.030
	32	3.6101.032
34	3.6101.034	
36	3.6101.036	
38	3.6101.038	
40	3.6101.040	

CHARSPINE OCT ŚRUBA POLIAKSJALNA CZĘŚCIOWO GWINTOWANA
 CHARSPINE OCT POLYAXIAL SCREW PARTIALLY THREADED
 CHARSPINE OCT ВИНТ ПОЛИАКСИАЛЬНЫЙ С ЧАСТИЧНОЙ РЕЗЬБОЙ

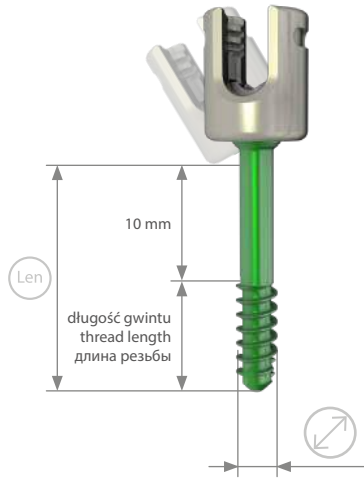

	Len	długość gwintu [mm] Thread length [mm] длина резьбы [мм]	Ti
3.5	24	14	3.5998.024
	26	16	3.5998.026
	28	18	3.5998.028
	30	20	3.5998.030
	32	22	3.5998.032
	34	24	3.5998.034
4.0	36	26	3.5998.036
	24	14	3.5997.024
	26	16	3.5997.026
	28	18	3.5997.028
	30	20	3.5997.030
	32	22	3.5997.032
	34	24	3.5997.034
	36	26	3.5997.036

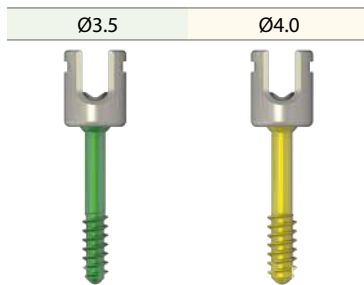

CHARSPINE OCT WKREŃ BLOKUJĄCY
 CHARSPINE OCT LOCKING SCREW
 CHARSPINE OCT ВИНТ ЗАЖИМНОЙ



Ti	
3.6111.000	✓

CHARSPINE OCT ŁĄCZNIK PRZEGUBOWY (ŁEB DO ŁBA)
 CHARSPINE OCT ARTICULATED CONNECTOR (HEAD TO HEAD)
 CHARSPINE OCT СОЕДИНИТЕЛЬ ШАРНИРНЫЙ (ГОЛОВКА К ГОЛОВКЕ)



Len	Ti
29÷35	3.5996.035
34÷40	3.5996.040
39÷45	3.5996.045
44÷50	3.5996.050
49÷55	3.5996.055

CHARSPINE OCT WKRĘT BLOKUJĄCY
 CHARSPINE OCT LOCKING SCREW
 CHARSPINE OCT ВИНТ ЗАЖИМНОЙ

	Ti	
	3.5991.000	✓
	3.5990.000	✓

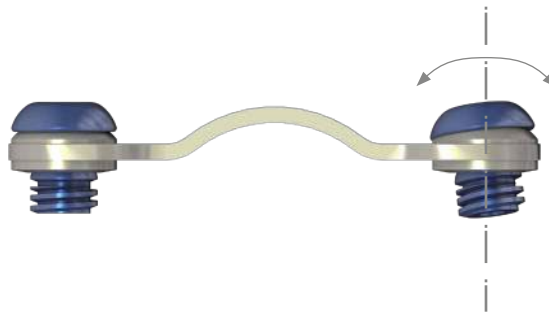

CHARSPINE OCT ŁĄCZNIK PRZEGUBOWY (PRĘT DO PRĘTA)
 CHARSPINE OCT ARTICULATED CONNECTOR (ROD TO ROD)
 CHARSPINE OCT СОЕДИНИТЕЛЬ ШАРНИРНЫЙ (СТЕРЖЕНЬ К СТЕРЖНЮ)



Len	Ti
29÷34	3.6104.034
33÷42	3.6104.042
40÷55	3.6104.055

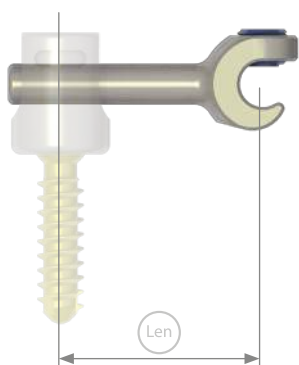

CHARSPINE OCT ŁĄCZNIK BOCZNY
 CHARSPINE OCT LATERAL CONNECTOR
 CHARSPINE OCT СОЕДИНИТЕЛЬ ЛАТЕРАЛЬНЫЙ

Len	Ti
9÷12	3.6103.012
9÷20	3.6103.020



Len	Ti
4.5	3.6102.001
6	3.6102.002

CHARSPINE OCT WKRĘT BLOKUJĄCY
 CHARSPINE OCT LOCKING SCREW
 CHARSPINE OCT ВИНТ ЗАЖИМНОЙ



Ti	
3.6111.000	✓

	Ti
① Hak laminarny szyjny Cervical laminar hook Крючок ламинарный шейный	3.6102.001
② Hak laminarny szyjny duży Cervical laminar hook large Крючок ламинарный шейный большой	3.6102.002



CHARSPINE OCT ŁĄCZNIK WSPÓŁOSIOWY
 CHARSPINE OCT AXIAL CONNECTO
 CHARSPINE OCT СОЕДИНИТЕЛЬ КОАКСИАЛЬНЫЙ

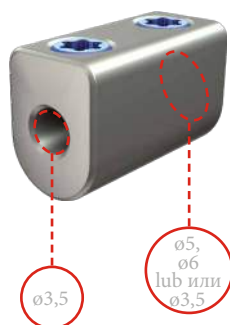

Len	Ti
rozmiar size размер	
6/3,5	3.3970.863
5/3,5	3.3970.853
3,5/3,5	3.3970.833

CHARSPINE OCT ŁĄCZNIK RÓWNOLEGŁY
 CHARSPINE OCT PARALLEL CONNECTOR
 CHARSPINE OCT СОЕДИНИТЕЛЬ ПАРАЛЛЕЛЬНЫЙ



Len	Ti
rozmiar size размер	
6/3,5	3.3970.963
5/3,5	3.3970.953
3,5/3,5	3.3970.933

CHARSPINE OCT PRĘT Ø6,0/Ø3,5
 CHARSPINE OCT ROD Ø6.0/Ø3.5
 CHARSPINE OCT СТЕРЖЕНЬ Ø6,0/Ø3,5



Len

Ti

	Len	Ti
①	400	3.6106.400

CHARSPINE OCT PRĘT Ø3,5
 CHARSPINE OCT ROD Ø3.5
 CHARSPINE OCT СТЕРЖЕНЬ Ø3,5

Len

Ti

	Len	Ti
	40	3.6105.040
	60	3.6105.060
②	90	3.6105.090
	150	3.6105.150
	240	3.6105.240



Len



CHARSPINE OCT PŁYTKA POTYLICZNA
 CHARSPINE OCT OCCIPITAL PLATE
 CHARSPINE OCT ПЛАСТИНА ДЛЯ ЗАТЫЛКА



CHARSPINE OCT WKREŃ BLOKUJĄCY
 CHARSPINE OCT LOCKING SCREW
 CHARSPINE OCT ВИНТ ЗАЖИМНОЙ

Len	Ti
mała/small /малая (25÷35)	3.6107.035
średnia/medium/средняя (35÷45)	3.6107.045
duża/large/большая (45÷55)	3.6107.055

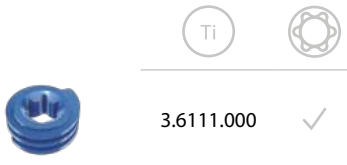

3.6111.000 ✓

CHARSPINE OCT PŁYTKA POTYLICZNA OBUSTRONNA
 CHARSPINE OCT BILATERAL OCCIPITAL PLATE
 CHARSPINE OCT ПЛАСТИНА ДЛЯ ЗАТЫЛКА ДВУСТОРОННЯЯ



Len	Ti
200	3.5995.204

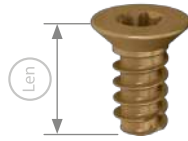

	Len	Ti
4,0	6	3.6109.006
	8	3.6109.008
	10	3.6109.010
	12	3.6109.012
	14	3.6109.014
	16	3.6109.016
4,5	6	3.6110.006
	8	3.6110.008
	10	3.6110.010
	12	3.6110.012
	14	3.6110.014
	16	3.6110.016

40.8346.000

Paleta na implanty CHARSPINE OCT
Palette for CHARSPINE OCT implants
Поддон для имплантатов CHARSPINE OCT



















Nr katalogowy
Catalogue no.
№ по кат.



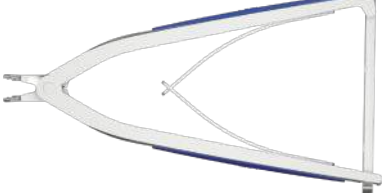





Paleta na implanty CHARSPINE OCT
Palette for CHARSPINE OCT implants
Поддон для имплантатов CHARSPINE OCT





40.8346.000

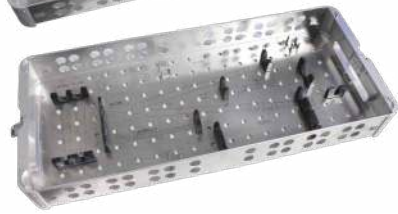









15.0915.101	CHARSPINE OCT Instrumentarium podstawowe CHARSPINE OCT Instrument set - basic CHARSPINE OCT Инструменты основные	Nr katalogow Catalogue no. № по кат.	Szt Pcs Шт.
	Wyginak pręta regulowany Adjustable rod bender Выгибатель стержня регулируемый	40.5770.000	1
	Szczypce dystrykcyjne Distraction forceps Дистракционные клещи	40.5771.000	1
	Szczypce kompresyjne Compression forceps Компрессионные клещи	40.5772.000	1
	Tuleja prowadząca regulowana Adjustable guide sleeve Втулка направляющая регулируемая	40.5773.000	1
	Kleszcze Forceps Щипцы	40.5774.000	1
	Klucz kontrujący Counter wrench Ключ контрующий	40.5775.000	1
	Manipulator do śrub Screw persuader Манипулятор для винтов	40.5776.000	1

15.0915.101	CHARSPINE OCT Instrumentarium podstawowe CHARSPINE OCT Instrument set - basic CHARSPINE OCT Инструменты основные	Nr katalogow Catalogue no. № по кат.	Szt Pcs Шт.
	Wiertło z ogranicznikiem 2,4 Drill with limiter 2.4 Сверло с ограничителем 2,4	40.5777.024	1
	Wiertło z ogranicznikiem 2,9 Drill with limiter 2.9 Сверло с ограничителем 2,9	40.5777.029	1
	Wiertło z ogranicznikiem 3,4 Drill with limiter 3.4 Сверло с ограничителем 3,4	40.5777.034	1
	Gwintownik 3,5mm Tap 3.5mm Метчик 3,5мм	40.5778.035	1
	Gwintownik 4,0mm Tap 4.0mm Метчик 4,0мм	40.5778.040	1
	Gwintownik 4,5mm Tap 4.5mm Метчик 4,5мм	40.5778.045	1
	Sonda pedikularna Pedicle probe Зонд педикулярный	40.5779.000	1
	Wyginak do pręta 3,5 lewy Rod bender 3.5 left Выгибатель стержня 3,5 левый	40.5780.000	1
	Wyginak do pręta 3,5 prawy Rod bender 3.5 right Выгибатель стержня 3,5 правый	40.5781.000	1
	Preparator do haków Raspatory for hooks Распатор для крючков	40.5782.000	1
	Wkrętak T15 Screwdriver T15 Отвёртка T15	40.5783.000	1
	Chwytek do śrub wieloosiowych Polyaxial screws holder Захват для многоосевых винтов	40.5786.000	1
	Chwytek do haków Hook holder Захват для крючков	40.5787.000	1
	Nożyce gilotynowe do pręta Hand hold rod cutter Гилиотинные ножницы для стержня	40.5788.000	1
	Grot T15 Screwdriver tip T15 Наконечник T15	40.5789.000	1
	Tuleja ochronna Protective guide Втулка защитная	40.5790.000	1
	Klucz do śrub Wrench for screw Ключ для винтов	40.5791.000	1
	Trokar Trocar Троакап	40.6099.000	1

15.0915.101	CHARSPINE OCT Instrumentarium podstawowe CHARSPINE OCT Instrument set - basic CHARSPINE OCT Инструменты основные		Nr katalogowy Catalogue no. № по кат.	Szt Pcs Шт.
		Rękojeść dynamometryczna 3,3Nm (AO) Torque handle 3.3Nm (AO) Рукоятка динамометрическая 3,3Нм (AO)	40.6655.233	1
		Rękojeść ze sprzęgłem (AO) Handle ratchet device (AO) Рукоятка со сцеплением (AO)	40.6654.001	1
		Wzorzec głębokości Depth measure Измеритель глубины	40.8348.000	1
		Pokrywa kontenera 9x4 Container lid 9x4 Покрышка для контейнера 9x4	14.0915.103	1
		Paleta 9x4 1/2H Tray 9x4 1/2H Поддон 9x4 1/2H	14.0915.201	1
		Kontener 9x4H Container 9x4H Контейнер 9x4H	14.0915.101	1
		Kontener 9x4H Container 9x4H Контейнер 9x4H	14.0915.102	1

CHARSPINE OCT INSTRUMENTARIUM DODATKOWE 1
CHARSPINE OCT INSTRUMENT SET - ADDITIONAL 1
CHARSPINE OCT Инструменты дополнительные 1

15.0915.202	CHARSPINE OCT Instrumentarium dodatkowe 1 (narzędzia do stabilizacji potylicznej) CHARSPINE OCT Instrument set - additional 1 (instruments for occipital stabilization) CHARSPINE OCT Инструменты дополнительные 1 (инструменты для стабилизации затылка)		Szt Pcs Шт.	Nr katalogowy Catalogue no. № по кат.
		Wyginak do płytek potylicznych Bender for occipital plates Выгибатель для пластин для затылка	1	40.8350.000
		Wyginak do płytek potylicznych Bender for occipital plates Выгибатель для пластин для затылка	1	40.8351.000
		Wiertło przeg. z ogranicznikiem 2,9 Drill with joint and limiter 2.9 Сверло шарнирное с ограничителем 2,9	1	40.8352.029
		Wiertło przeg. z ogranicznikiem 3,4 Drill with joint and limiter 3.4 Сверло шарнирное с ограничителем 3,4	1	40.8352.034

15.0915.202	CHARSPINE OCT Instrumentarium dodatkowe 1 (narzędzia do stabilizacji potylicznej) CHARSPINE OCT Instrument set - additional 1 (instruments for occipital stabilization) CHARSPINE OCT Инструменты дополнительные 1 (инструменты для стабилизации затылка)	Nazwa Name Название	Szt Pcs Шт.	Nr katalogowy Catalogue no. № по кат.
		Wiertło z ogranicznikiem 2,9 Drill with limiter 2.9 Сверло с ограничителем 2,9	1	40.8353.029
		Wiertło z ogranicznikiem 3,4 Drill with limiter 3.4 Сверло с ограничителем 3,4	1	40.8353.034
		Gwintownik przegubowy 4,0mm Tap with joint 4.0 Метчик шарнирный 4,0	1	40.8354.040
		Gwintownik przegubowy 4,5mm Tap with joint 4.5 Метчик шарнирный 4,5	1	40.8354.045
		Gwintownik 4,0mm Tap 4.0 Метчик 4,0	1	40.8355.040
		Gwintownik 4,5mm Tap 4.5 Метчик 4,5	1	40.8355.045
		Tuleja prowadząca regulowana Adjustable guide sleeve Втулка направляющая регулируемая	1	40.8356.000
		Klucz kontrolujący Counter wrench Ключ контролирующий	1	40.8357.000
		Wkrętak T15 Screwdriver T15 Наконечник T15	1	40.8358.000
		Grot przegubowy T15 Screwdriver T15 with joint Наконечник шарнирный T15	1	40.8359.000
		Paleta 9x4 1/2H Tray 9x4 1/2H Поддон 9x4 1/2H	1	14.0915.202



CHARSPINE2 WKREŃ BLOKUJĄCY
CHARSPINE2 LOCKING SCREW
CHARSPINE2 ВИНТ ЗАЖИМНОЙ



3.6160.000 ✓

Ø4.0 Ø4.5 Ø5.0 Ø5.5 Ø6.0 Ø6.5 Ø7.5 Ø8.5 Ø9.5 Ø10.5

Kolory Colors Цвета



Len	Ti	Len	Ti
25	3.6150.525	25	3.6157.525
30	3.6150.530	30	3.6157.530
35	3.6150.535	35	3.6157.535
40	3.6150.540	40	3.6157.540
45	3.6150.545	45	3.6157.545
25	3.6151.525	50	3.6157.550
30	3.6151.530	55	3.6157.555
35	3.6151.535	60	3.6157.560
40	3.6151.540	65	3.6157.565
45	3.6151.545	70	3.6157.570
25	3.6152.525	75	3.6157.575
30	3.6152.530	80	3.6157.580
35	3.6152.535	85	3.6157.585
40	3.6152.540	90	3.6157.590
45	3.6152.545	95	3.6157.595
50	3.6152.550	100	3.6157.601
25	3.6153.525	25	3.6158.525
30	3.6153.530	30	3.6158.530
35	3.6153.535	35	3.6158.535
40	3.6153.540	40	3.6158.540
45	3.6153.545	45	3.6158.545
50	3.6153.550	50	3.6158.550
55	3.6153.555	55	3.6158.555
25	3.6154.525	60	3.6158.560
30	3.6154.530	65	3.6158.565
35	3.6154.535	70	3.6158.570
40	3.6154.540	75	3.6158.575
45	3.6154.545	80	3.6158.580
50	3.6154.550	85	3.6158.585
55	3.6154.555	90	3.6158.590
60	3.6154.560	95	3.6158.595
65	3.6154.565	100	3.6158.601
25	3.6155.525	25	3.6159.525
30	3.6155.530	30	3.6159.530
35	3.6155.535	35	3.6159.535
40	3.6155.540	40	3.6159.540
45	3.6155.545	45	3.6159.545
50	3.6155.550	50	3.6159.550
55	3.6155.555	55	3.6159.555
60	3.6155.560	60	3.6159.560
65	3.6155.565	65	3.6159.565
25	3.6156.525	70	3.6159.570
30	3.6156.530	75	3.6159.575
35	3.6156.535	80	3.6159.580
40	3.6156.540	85	3.6159.585
45	3.6156.545	90	3.6159.590
50	3.6156.550	95	3.6159.595
55	3.6156.555	100	3.6159.601
60	3.6156.560		
65	3.6156.565		
70	3.6156.570		
75	3.6156.575		
80	3.6156.580		
85	3.6156.585		
90	3.6156.590		



CHARSPINE2 WKREŃ BLOKUJĄCY
 CHARSPINE2 LOCKING SCREW
 CHARSPINE2 ВИНТ ЗАЖИМНОЙ

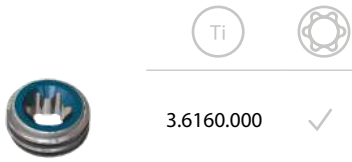

Ø4.0 Ø4.5 Ø5.0 Ø5.5 Ø6.0 Ø6.5 Ø7.5 Ø8.5 Ø9.5 Ø10.5

Kolory Colors Цвета



Len	Ti	Len	Ti
25	3.6161.525	25	3.6168.525
30	3.6161.530	30	3.6168.530
35	3.6161.535	35	3.6168.535
40	3.6161.540	40	3.6168.540
45	3.6161.545	45	3.6168.545
25	3.6162.525	50	3.6168.550
30	3.6162.530	55	3.6168.555
35	3.6162.535	60	3.6168.560
40	3.6162.540	65	3.6168.565
45	3.6162.545	70	3.6168.570
25	3.6163.525	75	3.6168.575
30	3.6163.530	80	3.6168.580
35	3.6163.535	85	3.6168.585
40	3.6163.540	90	3.6168.590
45	3.6163.545	95	3.6168.595
50	3.6163.550	100	3.6168.601
25	3.6164.525	25	3.6169.525
30	3.6164.530	30	3.6169.530
35	3.6164.535	35	3.6169.535
40	3.6164.540	40	3.6169.540
45	3.6164.545	45	3.6169.545
50	3.6164.550	50	3.6169.550
55	3.6164.555	55	3.6169.555
25	3.6165.525	60	3.6169.560
30	3.6165.530	65	3.6169.565
35	3.6165.535	70	3.6169.570
40	3.6165.540	75	3.6169.575
45	3.6165.545	80	3.6169.580
50	3.6165.550	85	3.6169.585
55	3.6165.555	90	3.6169.590
60	3.6165.560	95	3.6169.595
65	3.6165.565	100	3.6169.601
25	3.6166.525	25	3.6149.525
30	3.6166.530	30	3.6149.530
35	3.6166.535	35	3.6149.535
40	3.6166.540	40	3.6149.540
45	3.6166.545	45	3.6149.545
50	3.6166.550	50	3.6149.550
55	3.6166.555	55	3.6149.555
60	3.6166.560	60	3.6149.560
65	3.6166.565	65	3.6149.565
25	3.6167.525	70	3.6149.570
30	3.6167.530	75	3.6149.575
35	3.6167.535	80	3.6149.580
40	3.6167.540	85	3.6149.585
45	3.6167.545	90	3.6149.590
50	3.6167.550	95	3.6149.595
55	3.6167.555	100	3.6149.601
60	3.6167.560		
65	3.6167.565		
70	3.6167.570		
75	3.6167.575		
80	3.6167.580		
85	3.6167.585		
90	3.6167.590		

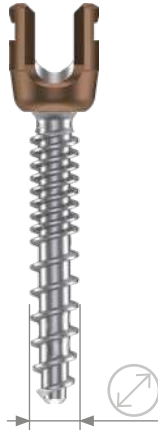

CHARSPINE2 WKREŃ BLOKUJĄCY
CHARSPINE2 LOCKING SCREW
CHARSPINE2 ВИНТ ЗАЖИМНОЙ



Ti



3.6160.000 ✓

Ø4.0 Ø4.5 Ø5.0 Ø5.5 Ø6.0 Ø6.5 Ø7.5 Ø8.5 Ø9.5 Ø10.5

Kolory Colors Цвета



	Len	Ti		Len	Ti
4.0	25	3.6170.525	8.5	25	3.6530.525
	30	3.6170.530		30	3.6530.530
	35	3.6170.535		35	3.6530.535
	40	3.6170.540		40	3.6530.540
	45	3.6170.545		45	3.6530.545
	50	3.6170.550		50	3.6530.550
4.5	25	3.6171.525	8.5	55	3.6530.555
	30	3.6171.530		60	3.6530.560
	35	3.6171.535		65	3.6530.565
	40	3.6171.540		70	3.6530.570
	45	3.6171.545		75	3.6530.575
	50	3.6171.550		80	3.6530.580
5.0	25	3.6172.525	8.5	85	3.6530.585
	30	3.6172.530		90	3.6530.590
	35	3.6172.535		95	3.6530.595
	40	3.6172.540		100	3.6530.600
	45	3.6172.545		25	3.6531.525
	50	3.6172.550		30	3.6531.530
5.5	55	3.6172.555	9.5	35	3.6531.535
	25	3.6173.525		40	3.6531.540
	30	3.6173.530		45	3.6531.545
	35	3.6173.535		50	3.6531.550
	40	3.6173.540		55	3.6531.555
	45	3.6173.545		60	3.6531.560
6.0	50	3.6173.550	9.5	65	3.6531.565
	55	3.6173.555		70	3.6531.570
	25	3.6174.525		75	3.6531.575
	30	3.6174.530		80	3.6531.580
	35	3.6174.535		85	3.6531.585
	40	3.6174.540		90	3.6531.590
6.5	45	3.6174.545	10.5	95	3.6531.595
	50	3.6174.550		100	3.6531.600
	55	3.6174.555		25	3.6532.525
	60	3.6174.560		30	3.6532.530
	65	3.6174.565		35	3.6532.535
	25	3.6175.525		40	3.6532.540
7.0	30	3.6175.530	10.5	45	3.6532.545
	35	3.6175.535		50	3.6532.550
	40	3.6175.540		55	3.6532.555
	45	3.6175.545		60	3.6532.560
	50	3.6175.550		65	3.6532.565
	55	3.6175.555		70	3.6532.570
7.5	60	3.6175.560	10.5	75	3.6532.575
	65	3.6175.565		80	3.6532.580
	25	3.6176.525		85	3.6532.585
	30	3.6176.530		90	3.6532.590
	35	3.6176.535		95	3.6532.595
	40	3.6176.540		100	3.6532.600
8.0	45	3.6176.545	7.5	50	3.6176.550
	50	3.6176.550		55	3.6176.555
	55	3.6176.555		60	3.6176.560
	60	3.6176.560		65	3.6176.565
	65	3.6176.565		70	3.6176.570
	70	3.6176.570		75	3.6176.575
8.5	75	3.6176.575	7.5	80	3.6176.580
	80	3.6176.580		85	3.6176.585
	85	3.6176.585		90	3.6176.590
	90	3.6176.590			



CHARSPINE2 WKREŃ BLOKUJĄCY
CHARSPINE2 LOCKING SCREW
CHARSPINE2 ВИНТ ЗАЖИМНОЙ



3.6160.000 ✓

Ø4.0 Ø4.5 Ø5.0 Ø5.5 Ø6.0 Ø6.5 Ø7.5 Ø8.5 Ø9.5 Ø10.5

Kolory Colors Цвета



	Len	Ti		Len	Ti
4.0	25	3.6177.525	8.5	25	3.6533.525
	30	3.6177.530		30	3.6533.530
	35	3.6177.535		35	3.6533.535
	40	3.6177.540		40	3.6533.540
	45	3.6177.545		45	3.6533.545
4.5	25	3.6178.525	9.5	50	3.6533.550
	30	3.6178.530		55	3.6533.555
	35	3.6178.535		60	3.6533.560
	40	3.6178.540		65	3.6533.565
	45	3.6178.545		70	3.6533.570
5.0	20	3.6179.520	10.5	75	3.6533.575
	25	3.6179.525		80	3.6533.580
	30	3.6179.530		85	3.6533.585
	35	3.6179.535		90	3.6533.590
	40	3.6179.540		95	3.6533.595
5.5	45	3.6179.545	100	100	3.6533.600
	50	3.6179.550		25	3.6534.525
	25	3.6180.525		30	3.6534.530
	30	3.6180.530		35	3.6534.535
	35	3.6180.535		40	3.6534.540
6.0	40	3.6180.540	9.5	45	3.6534.545
	45	3.6180.545		50	3.6534.550
	50	3.6180.550		55	3.6534.555
	55	3.6180.555		60	3.6534.560
	25	3.6181.525		65	3.6534.565
6.5	30	3.6181.530	10.5	70	3.6534.570
	35	3.6181.535		75	3.6534.575
	40	3.6181.540		80	3.6534.580
	45	3.6181.545		85	3.6534.585
	50	3.6181.550		90	3.6534.590
7.5	55	3.6181.555	100	95	3.6534.595
	60	3.6181.560		100	3.6534.600
	65	3.6181.565		25	3.6535.525
	25	3.6182.525		30	3.6535.530
	30	3.6182.530		35	3.6535.535
8.5	35	3.6182.535	10.5	40	3.6535.540
	40	3.6182.540		45	3.6535.545
	45	3.6182.545		50	3.6535.550
	50	3.6182.550		55	3.6535.555
	55	3.6182.555		60	3.6535.560
9.5	60	3.6182.560	10.5	65	3.6535.565
	65	3.6182.565		70	3.6535.570
	25	3.6183.525		75	3.6535.575
	30	3.6183.530		80	3.6535.580
	35	3.6183.535		85	3.6535.585
10.5	40	3.6183.540	100	90	3.6535.590
	45	3.6183.545		95	3.6535.595
	50	3.6183.550		100	3.6535.600
	55	3.6183.555		25	3.6535.525
	60	3.6183.560		30	3.6535.530
11.5	65	3.6183.565	10.5	35	3.6535.535
	70	3.6183.570		40	3.6535.540
	75	3.6183.575		45	3.6535.545
	80	3.6183.580		50	3.6535.550
	85	3.6183.585		55	3.6535.555
12.5	90	3.6183.590	10.5	60	3.6535.560
	95	3.6183.595		65	3.6535.565
	100	3.6183.600		70	3.6535.570
	25	3.6183.525		75	3.6535.575
	30	3.6183.530		80	3.6535.580

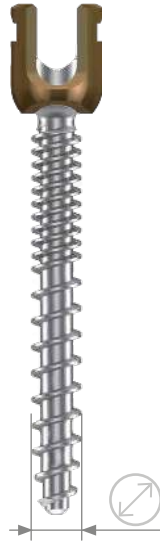

CHARSPINE2 WKREŃ BLOKUJĄCY
 CHARSPINE2 LOCKING SCREW
 CHARSPINE2 ВИНТ ЗАЖИМНОЙ



3.6160.000



	Len	Ti
6.5	25	3.6514.525
	30	3.6514.530
	35	3.6514.535
	40	3.6514.540
	45	3.6514.545
	50	3.6514.550
	55	3.6514.555
	60	3.6514.560
	65	3.6514.565
	70	3.6514.570
7.5	75	3.6514.575
	80	3.6514.580
	85	3.6514.585
	90	3.6514.590
	25	3.6515.525
	30	3.6515.530
	35	3.6515.535
	40	3.6515.540
	45	3.6515.545
	50	3.6515.550
7.5	55	3.6515.555
	60	3.6515.560
	65	3.6515.565
	70	3.6515.570
	75	3.6515.575
	80	3.6515.580
	85	3.6515.585
	90	3.6515.590

Ø6.5 Ø7.5

Kolory Colors
 Цвета



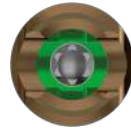

Dla wzrokowego odróżnienia śrub uniplanarnych od poliaksjalnych, element wewnętrzny w główce śruby uniplanarnej jest barwiony na kolor zielony.



For the visual distinction of uniplanar from polyaxial screws, the inner element in the uniplanar screw is green anodized.

Для визуального отличия винтов унипланарных от полиаксиальных, внутренний элемент в головке винта унипланарного кодирован в зелёный цвет.

CHARSPINE2 WKREŃ BLOKUJĄCY
CHARSPINE2 LOCKING SCREW
CHARSPINE2 ВИНТ ЗАЖИМНОЙ



Ti



3.6160.000



Ø4.0 Ø4.5 Ø5.0 Ø5.5 Ø6.0 Ø6.5 Ø7.5

Kolory Colors Цвета



	Len	Ti	
4.0	25	3.6184.525	
	30	3.6184.530	
	35	3.6184.535	
	40	3.6184.540	
	45	3.6184.545	
4.5	25	3.6185.525	
	30	3.6185.530	
	35	3.6185.535	
	40	3.6185.540	
5.0	45	3.6185.545	
	25	3.6186.525	
	30	3.6186.530	
	35	3.6186.535	
	40	3.6186.540	
5.5	45	3.6186.545	
	50	3.6186.550	
	25	3.6187.525	
	30	3.6187.530	
	35	3.6187.535	
	40	3.6187.540	
6.0	45	3.6187.545	
	50	3.6187.550	
	55	3.6187.555	
	25	3.6188.525	
	30	3.6188.530	
	35	3.6188.535	
6.5	40	3.6188.540	
	45	3.6188.545	
	50	3.6188.550	
	55	3.6188.555	
	60	3.6188.560	
	65	3.6188.565	
7.5	25	3.6189.525	
	30	3.6189.530	
	35	3.6189.535	
	40	3.6189.540	
	45	3.6189.545	
	50	3.6189.550	
	55	3.6189.555	
	60	3.6189.560	
	65	3.6189.565	
	70	3.6189.570	
8.0	75	3.6189.575	
	80	3.6189.580	
	85	3.6189.585	
	90	3.6189.590	
	8.5	85	3.6190.585
		90	3.6190.590

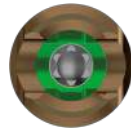

Dla wzrokowego odróżnienia śrub uniplanarnych od poliaksjalnych, element wewnętrzny w główce śruby uniplanarnej jest barwiony na kolor zielony.

For the visual distinction of uniplanar from polyaxial screws, the inner element in the uniplanar screw is green anodized.

Для визуального отличия винтов унипланарных от полиаксиальных, внутренний элемент в головке винта унипланарного кодирован в зелёный цвет.



CHARSPINE2 WKREŃ BLOKUJĄCY
 CHARSPINE2 LOCKING SCREW
 CHARSPINE2 ВИНТ ЗАЖИМНОЙ



3.6160.000 ✓

Ø4.0 Ø4.5 Ø5.0 Ø5.5 Ø6.0 Ø6.5 Ø7.5

Kolory Colors Цвета



	Len	Ti
4.0	25	3.6191.525
	30	3.6191.530
	35	3.6191.535
	40	3.6191.540
	45	3.6191.545
4.5	25	3.6192.525
	30	3.6192.530
	35	3.6192.535
	40	3.6192.540
5.0	45	3.6192.545
	25	3.6193.525
	30	3.6193.530
	35	3.6193.535
	40	3.6193.540
5.5	45	3.6193.545
	50	3.6193.550
	25	3.6194.525
	30	3.6194.530
	35	3.6194.535
6.0	40	3.6194.540
	45	3.6194.545
	50	3.6194.550
	55	3.6194.555
	60	3.6194.560
6.5	65	3.6194.565
	25	3.6195.525
	30	3.6195.530
	35	3.6195.535
	40	3.6195.540
7.0	45	3.6195.545
	50	3.6195.550
	55	3.6195.555
	60	3.6195.560
	65	3.6195.565
7.5	25	3.6196.525
	30	3.6196.530
	35	3.6196.535
	40	3.6196.540
	45	3.6196.545
8.0	50	3.6196.550
	55	3.6196.555
	60	3.6196.560
	65	3.6196.565
	70	3.6196.570
8.5	75	3.6196.575
	80	3.6196.580
	85	3.6196.585
	90	3.6196.590
	95	3.6196.595

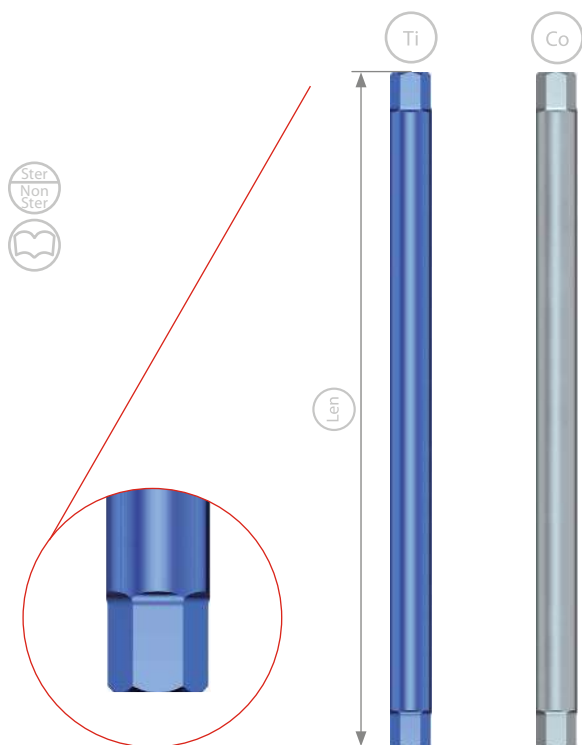

Len	Ti	Co
40	3.3246.040	4.3980.040
50	3.3246.050	4.3980.050
60	3.3246.060	4.3980.060
70	3.3246.070	4.3980.070
80	3.3246.080	4.3980.080
90	3.3246.090	4.3980.090
100	3.3246.100	4.3980.100
120	3.3246.120	4.3980.120
140	3.3246.140	4.3980.140
160	3.3246.160	4.3980.160
180	3.3246.180	4.3980.180
200	3.3246.200	4.3980.200
220	3.3246.220	4.3980.220
260	3.3246.260	4.3980.260
300	3.3246.300	4.3980.300
360	3.3246.360	4.3980.360
400	3.3246.400	4.3980.400
460	3.3246.460	4.3980.460
500	3.3246.500	4.3980.500

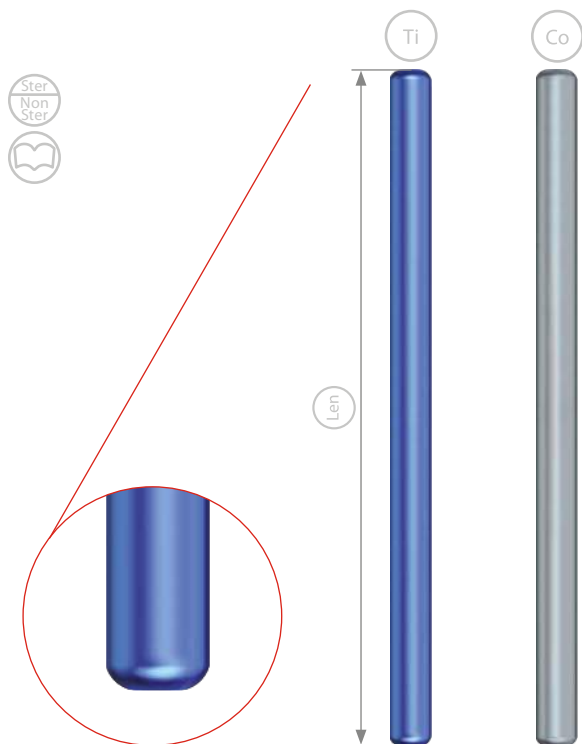

Len	Ti	Co
40	3.3248.040	4.3249.040
50	3.3248.050	4.3249.050
60	3.3248.060	4.3249.060
70	3.3248.070	4.3249.070
80	3.3248.080	4.3249.080
90	3.3248.090	4.3249.090
100	3.3248.100	4.3249.100
120	3.3248.120	4.3249.120
140	3.3248.140	4.3249.140
160	3.3248.160	4.3249.160
180	3.3248.180	4.3249.180
200	3.3248.200	4.3249.200

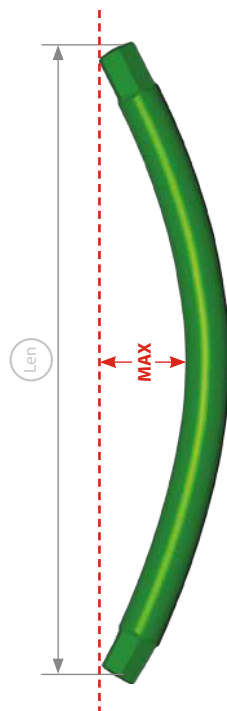
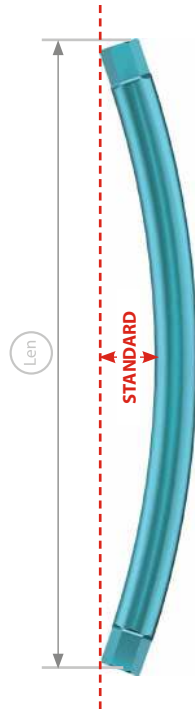

Len	Ti
35	3.6280.035
40	3.6280.040
45	3.6280.045
50	3.6280.050
55	3.6280.055
60	3.6280.060
65	3.6280.065
70	3.6280.070
75	3.6280.075
80	3.6280.080
85	3.6280.085
90	3.6280.090
95	3.6280.095
100	3.6280.100
110	3.6280.110
120	3.6280.120
130	3.6280.130
140	3.6280.140
150	3.6280.150
160	3.6280.160
170	3.6280.170
180	3.6280.180
190	3.6280.190
200	3.6280.200

Len	Ti
35	3.6295.035
40	3.6295.040
45	3.6295.045
50	3.6295.050
55	3.6295.055
60	3.6295.060
65	3.6295.065
70	3.6295.070
75	3.6295.075
80	3.6295.080
85	3.6295.085

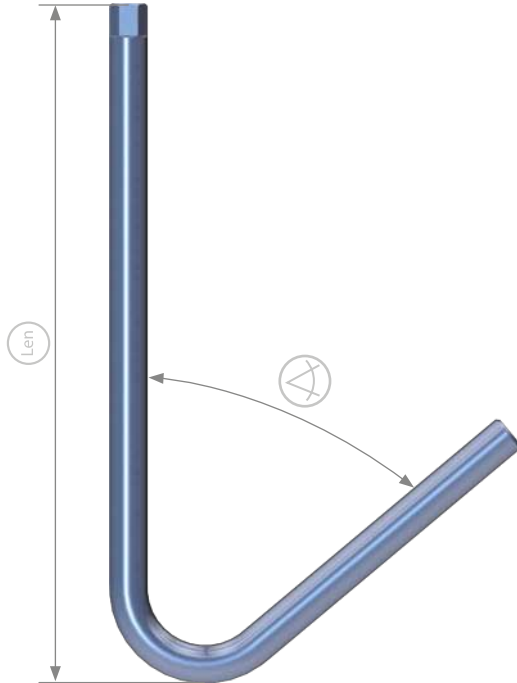

	Len	Ti
50°	150	3.3981.155
	200	3.3981.205
	250	3.3981.255
	300	3.3981.305
	350	3.3981.355
	450	3.3981.455
60°	150	3.3981.156
	200	3.3981.206
	250	3.3981.256
	300	3.3981.306
	350	3.3981.356
	450	3.3981.456
70°	150	3.3981.157
	200	3.3981.207
	250	3.3981.257
	300	3.3981.307
	350	3.3981.357
	450	3.3981.457

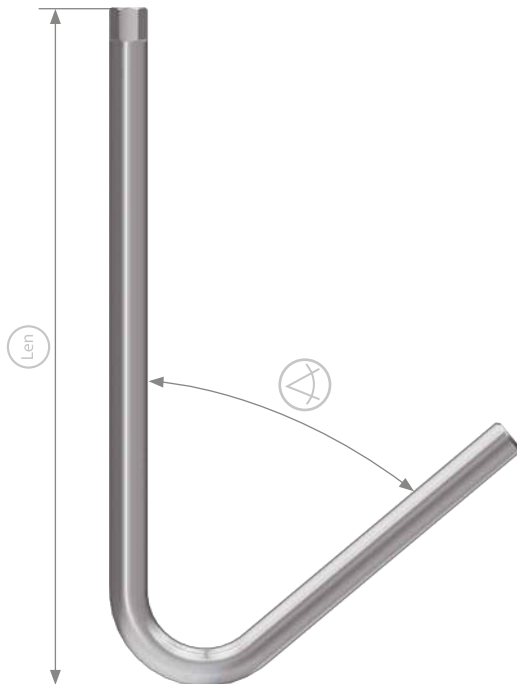

	Len	Co
50°	150	4.3981.155
	200	4.3981.205
	250	4.3981.255
	300	4.3981.305
	350	4.3981.355
	450	4.3981.455
60°	150	4.3981.156
	200	4.3981.206
	250	4.3981.256
	300	4.3981.306
	350	4.3981.356
	450	4.3981.456
70°	150	4.3981.157
	200	4.3981.207
	250	4.3981.257
	300	4.3981.307
	350	4.3981.357
	450	4.3981.457

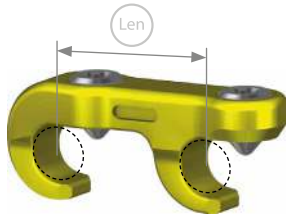

Len	Ti
14	3.6290.014
15	3.6290.015
16	3.6290.016
17	3.6290.017
18	3.6290.018
19	3.6290.019
20	3.6290.020
21	3.6290.021
22	3.6290.022
23	3.6290.023
24	3.6290.024
25	3.6290.025
26	3.6290.026
27	3.6290.027
28	3.6290.028
29	3.6290.029
30	3.6290.030

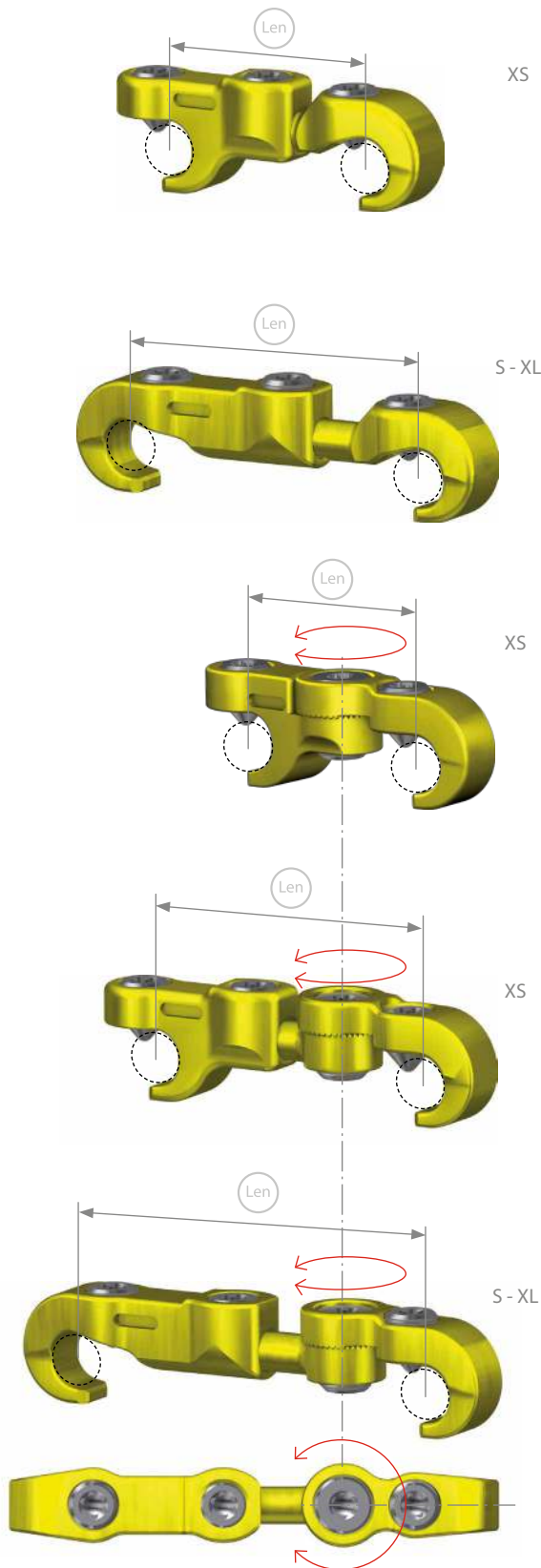

	Len	Ti
XS	26-30.5	3.3979.026

	Len	Ti
S	30.5-33	3.3979.030
M	33-38.5	3.3979.033
L	38.5-49	3.3979.038
XL	49-71	3.3979.049

	Len	Ti
XS	22	3.6296.022
	24	3.6296.024
	26	3.6296.026
	28	3.6296.028
	30	3.6296.030
	32	3.6296.032
	34	3.6296.034

	Len	Ti
XS	33-37.5	3.3972.033

	Len	Ti
S	37.5-40	3.3972.037
M	40-45.5	3.3972.040
L	45.5-56.5	3.3972.045
XL	56.5-78	3.3972.056
XXL	78-99	3.3972.078



d	D	Ti
5	5	3.3970.855
6	5	3.3970.865
6	6	3.3970.866

ŁĄCZNIK RÓWNOLEGŁY
PARALLEL CONNECTOR
ПАРАЛЛЕЛЬНЫЙ СОЕДИНИТЕЛЬ

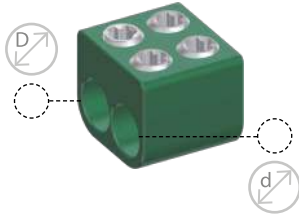



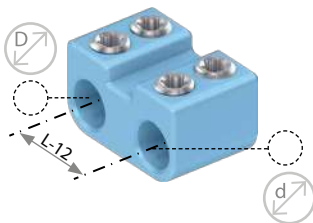

d	D	Ti
5	5	3.3970.955
6	5	3.3970.965
6	6	3.3970.966

ŁĄCZNIK RÓWNOLEGŁY
PARALLEL CONNECTOR
ПАРАЛЛЕЛЬНЫЙ СОЕДИНИТЕЛЬ

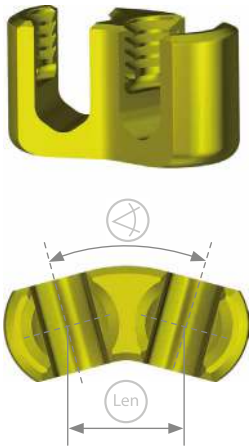

d	D	Ti
6	6	3.6294.012



			
0°		12	3.6284.012
		16	3.6284.016
10°		12	3.6285.012
		16	3.6285.016
30°		12	3.6286.012
		16	3.6286.016



CHARSPINE2 WKREŃ BLOKUJĄCY
CHARSPINE2 LOCKING SCREW
ЗАЖИМНОЙ ВИНТ CHARSPINE2

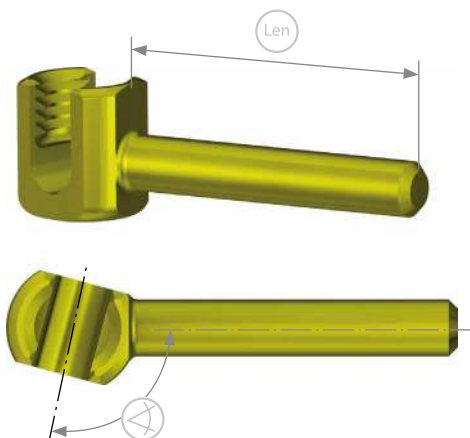

3.6160.000 ✓



ŁĄCZNIK BOCZNY
LATERAL CONNECTOR
СОЕДИНИТЕЛЬ ЛАТЕРАЛЬНЫЙ

			
90°		15	3.6281.015
		20	3.6281.020
		25	3.6281.025
		30	3.6281.030
		35	3.6281.035
75°		15	3.6282.015
		20	3.6282.020
		25	3.6282.025
		30	3.6282.030
		35	3.6282.035
105°		15	3.6283.015
		20	3.6283.020
		25	3.6283.025
		30	3.6283.030
		35	3.6283.035

CHARSPINE2 WKREŃ BLOKUJĄCY
CHARSPINE2 LOCKING SCREW
ЗАЖИМНОЙ ВИНТ CHARSPINE2



3.6160.000 ✓

ŁĄCZNIK POPRZECZNY KLAMROWY
CLAMP CROSSWISE CONNECTOR
СОЕДИНИТЕЛЬ СКОБООБРАЗНЫЙ ПОПЕРЕЧНЫЙ

CHARSPINE *system 2*



Ti

3.6287.000



ŁĄCZNIK PRĘTOWY
ROD CONNECTOR
СОЕДИНИТЕЛЬ СТЕРЖНЯ

CHARSPINE *system 2*















Len

Ti

Len	Ti
35	3.6289.035
40	3.6289.040
45	3.6289.045
50	3.6289.050
55	3.6289.055
60	3.6289.060
65	3.6289.065
70	3.6289.070
80	3.6289.080
90	3.6289.090
100	3.6289.100





Mały Small Малый	Standardowy Standard Стандартный	Duży Large Большой
Hak laminarny Laminar hook Ламинарный крючок		
 3.6266.001	 3.6266.002	 3.6266.003
Hak laminarny wąskie ostrze Laminar hook narrow blade Ламинарный крючок узкое лезвие		
 3.6267.001	 3.6267.002	 3.6267.003
Hak laminarny wydłużony Laminar hook extended body Ламинарный крючок с удлиненным телом		
3.6268.001*	 3.6268.002	3.6268.003*
Hak laminarny odsadzony Laminar hook offset Ламинарный крючок офсетный		
3.6269.001 – prawy right правый * 3.6269.101 – lewy left левый *	 3.6269.002 – prawy right правый 3.6269.102 – lewy left левый	3.6269.003 – prawy right правый * 3.6269.103 – lewy left левый *
Hak laminarny odgięte ostrze Laminar hook angled blade Ламинарный крючок угловой		
3.6270.001*	 3.6270.002	3.6270.003*
Hak laminarny piersiowy Thoracic laminar hook Торакальный ламинарный крючок		
	 3.6271.002	
Hak laminarny piersiowy wąskie ostrze Thoracic laminar hook narrow blade Торакальный ламинарный крючок узкое лезвие		
	 3.6272.002	
Hak laminarny piersiowy odsadzony Thoracic laminar hook offset Торакальный ламинарный крючок офсетный		
	 3.6273.002 – małe odsadzenie, prawy; Small offset, right; небольшое смещение, правый 3.6273.102 – małe odsadzenie, lewy; Small offset, left; небольшое смещение, левый 3.6274.002 – duże odsadzenie, prawy; Large offset, right; большое смещение, правый 3.6274.102 – duże odsadzenie, lewy; Large offset, left; большое смещение, левый	



Mały Small Малый	Standardowy Standard Стандартный	Duży Large Большой
Hak pedikularny Pedicle hook Педикулярный крючок		
 3.6275.001	 3.6275.002	 3.6275.003*
Hak na wyrostek poprzeczny Transverse process hook Крючок для поперечного отростка		
3.6276.001 – prawy right правый * 3.6276.101 – lewy left левый *	 3.6276.002 – prawy right правый 3.6276.102 – lewy left левый	3.6276.003 – prawy right правый * 3.6276.103 – lewy left левый *

* dodatkowo dostępne
available as additional item
доступные дополнительно



Przedstawione poniżej palety na implanty nie są oferowane jako zestawy (nie zawierają implantów).

The palettes for implants presented below are not offered as sets (they do not include implants).

Нижепредставленные поддоны для имплантатов не предлагаются в виде набора (не содержат имплантатов).

40.8064.000	Paleta na implanty charspine2-śruby 40.8064.000 Palette for charspine2 implants - screws 40.8064.000 Поддон для имплантатов charspine2-винты 40.8064.000			Ilość gniazd No. of sockets Количество секций	
		Śruby monoaksjalne Monoaxial screws Винты моноаксиальные		25	2
				30	2
				35	2
				40	2
				45	2
				50	2
				35	2
				40	2
				45	2
				50	2
				55	2
				60	2
				30	8
				35	8
				40	8
				45	8
				50	8
				55	8
				35	8
				40	8
				45	8
				50	8
				55	8
				60	8
35	6				
40	6				
45	6				
50	6				
55	6				
60	6				
35	6				
40	6				
45	6				
50	6				
55	6				
60	6				
50	2				
55	2				
60	2				
70	2				
80	2				
90	2				
50	2				
55	2				
60	2				
70	2				
80	2				
90	2				
30	4				
35	4				
40	4				
45	4				
50	4				
55	4				
35	4				
40	4				
45	4				
50	4				
55	4				
60	4				
35	6				
40	6				
45	6				
50	6				
55	6				
60	6				
35	6				
40	6				
45	6				
50	6				
55	6				
60	6				
5.5	Śruby poliaksjalne Polyaxial screws Винты полиаксиальные			30	4
		Śruby poliaksjalne Polyaxial screws Винты полиаксиальные		35	4
				40	4
				45	4
				50	4
				55	4
				35	4
				40	4
				45	4
				50	4
				55	4
				60	4
				35	6
				40	6
				45	6
				50	6
				55	6
				60	6
				35	6
				40	6
				45	6
				50	6
				55	6
				60	6

40.8119.000 Paleta mała na implanty charspine2-śruby
Palette small for charspine2 implants - screws
Поддон маленький для имплантатов charspine2-винты



Śruby (monoaksjalne, poliaksjalne, uniplanarne)
Винты (моноаксиальные, полиаксиальные, унипланарные) Monoaxial, polyaxial and uniplanar screws

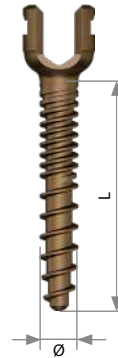

	Len	Ilość gniazd No. of sockets Количество секций
5.0	30	6
	35	6
	40	6
	45	6
	50	5
5.5	30	6
	35	6
	40	6
	45	6
	50	5
6.0	35	6
	40	6
	45	6
	50	6
	55	6
6.5	60	5
	35	6
	40	6
	45	6
	50	6
	55	6
	60	5

Paleta modułowa na implanty charspine2-łączniki 1 (konfiguracja standardowa)
Modular palette for charspine2 implants - connectors 1 (standard configuration)
Модульный поддон для имплантатов charspine2-соединители 1 (стандартная конфигурация)



40.8065.000
Paleta na implanty CHARSPINE2- łączniki 1
Palette for CHARSPINE2 implants - Connectors 1
Поддон для имплантатов CHARSPINE2-Соединители 1



40.8078.000
Moduł wymienny 1
Exchangeable module 1
Модуль сменный 1



40.8080.000
Moduł wymienny 3
Exchangeable module 3
Модуль сменный 3

40.8065.000 Paleta na implanty CHARSPINE2-Łączniki 1
Поддон для имплантатов CHARSPINE2-Соединители 1
Palette for CHARSPINE2 implants - Connectors 1



Typ implantu Implant type Тип имплантата	Rozmiar Size Размер	Ilość gniazd No. of sockets Количество секций
Pręty Rod Стержни	L-40	2
	L-50	2
	L-60	2
	L-70	2
	L-80	2
	L-90	2
	L-100	2
	L-120	4
	L-160	4
	L-200	4
	L-220	4
	L-260	4
	L-300	2
	L-360	2
	L-460	2

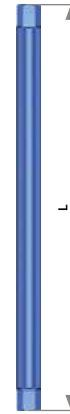

Łącznik prętowy Rod connectors Соединитель стержня	Rozmiar Size Размер	Ilość gniazd No. of sockets Количество секций
Łącznik prętowy Rod connectors Соединитель стержня	L-60	2
	L-80	2
	L-100	2

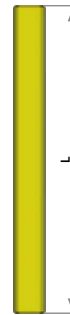

Wkręty blokujące Locking screws Винты зажимные	Rozmiar Size Размер	Ilość gniazd No. of sockets Количество секций
Wkręty blokujące Locking screws Винты зажимные	-	28



Łącznik współosiowy Axial connector Соединитель коаксиальный	Rozmiar Size Размер	Ilość gniazd No. of sockets Количество секций
Łącznik współosiowy Axial connector Соединитель коаксиальный	6/6	1



Łącznik równoległy Parallel connector Соединитель параллельный	Rozmiar Size Размер	Ilość gniazd No. of sockets Количество секций
Łącznik równoległy Parallel connector Соединитель параллельный	6/6	1



Łącznik poprzeczny klamrowy Clamp crosswise connector Соединитель скобообразный поперечный	Rozmiar Size Размер	Ilość gniazd No. of sockets Количество секций
Łącznik poprzeczny klamrowy Clamp crosswise connector Соединитель скобообразный поперечный	-	4



MODUŁY WYMIENNE – KONFIGURACJA GNIAZD NA IMPLANTY
МОДУЛИ СМЕННЫЕ - КОНФИГУРАЦИЯ СЕКЦИЙ ДЛЯ ИМПЛАТАТОВ
EXCHANGEABLE MODULES – IMPLANT SOCKETS CONFIGURATION



40.8078.000	Moduł wymienny 1 Exchangeable module 1 Модуль сменный 1	Typ implantu Implant type Тип имплантата	Rozmiar Size Размер	Ilość gniazd No. of sockets Количество секций
		Pręt zakrzywiony Curved rod Стержень изогнутый	L-35	1
		L-40	1	
		L-45	1	
		L-50	1	
		L-55	1	
		L-60	1	
		L-65	1	
		L-70	1	
		L-75	1	
		L-80	1	
L-85	1			

40.6795.000	Moduł wymienny 5 Exchangeable module 5 Модуль сменный 5	Typ implantu Implant type Тип имплантата	Rozmiar Size Размер	Ilość gniazd No. of sockets Количество секций
		Pręt zakrzywiony Curved rod Стержень изогнутый	L-90	1
		L-95	1	
		L-100	1	
		L-110	1	
		L-120	1	
		L-130	1	
		L-140	1	
		L-150	1	
		L-160	1	

40.8080.000	Moduł wymienny 3 Exchangeable module 3 Модуль сменный 3	Typ implantu Implant type Тип имплантата	Rozmiar Size Размер	Ilość gniazd No. of sockets Количество секций	
		Łącznik poprzeczny lity Crosswise connector solid поперечный сплошной	L-14	1	
			L-15	1	
			L-16	1	
			L-17	1	
			L-18	1	
			L-19	1	
			L-20	1	
			Łącznik poprzeczny regulowany (monoaksjalny) Crosswise connector regulated (monoaxial) Соединитель поперечный регулируемый (моноаксиальный)	XS	1
				S	1
				M	1
		L		1	
		Łącznik boczny (poliaksjalny) Lateral connector (polyaxial) Соединитель латеральный (полиаксиальный)	XS	1	
			S	1	
			M	1	
L	1				
XL	1				

Paleta modułowa na implanty charspine2-łączniki 2 (konfiguracja standardowa)
Modular palette for charspine2 implants - connectors 2 (standard configuration)
Модульный поддон для имплантатов charspine2-соединители 2 (стандартная конфигурация)

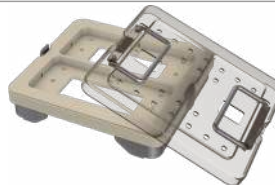

40.8066.000
Paleta na implanty Charspine2- łączniki 2
Palette for CHARSPINE2 implants - Connectors 2
Поддон для имплантатов CHARSPINE2-
Соединители 2



40.8081.000
Moduł wymienny 4
Exchangeable module 4
Модуль сменный 4



40.8079.000
Moduł wymienny 2
Exchangeable module 2
Модуль сменный 2

MODUŁY WYMIENNE – KONFIGURACJA GNIAZD NA IMPLANTY
EXCHANGEABLE MODULES – IMPLANT SOCKETS CONFIGURATION
МОДУЛИ СМЕННЫЕ - КОНФИГУРАЦИЯ СЕКЦИЙ ДЛЯ ИМПЛАТАТОВ

40.8081.000
Moduł wymienny 4
Exchangeable module 4
Модуль сменный 4

Typ implantu
Implant type
Тип имплантата

Rozmiar
Size
Размер

Ilość gniazd
No. of sockets
Количество секций

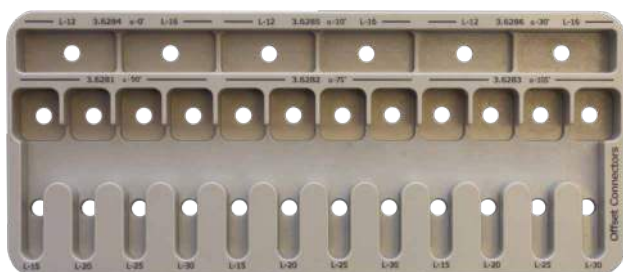

Łącznik kątowy
Angular connector
Соединитель угловой



Łącznik boczny
Lateral connector
Соединитель латеральный



L-12	1
L-16	1
10° L-12	1
10° L-16	1
30° L-12	1
30° L-16	1
90° L-15	1
90° L-20	1
90° L-25	1
90° L-30	1
75° L-15	1
75° L-20	1
75° L-25	1
75° L-30	1
105° L-15	1
105° L-20	1
105° L-25	1
105° L-30	1

40.8077.000	Paleta na implanty CHARSPINE2-Haki Поддон для имплантатов CHARSPINE2-Крючки Palette for CHARSPINE2 implants - Hooks	Typ implantu Implant type Тип имплантата	Odmiana Variant вариант	Ilość gniazd No. of sockets Количество секций
		 Hak laminarny Laminar hook Крючок ламинарный	Mały Small Малый	6
			Standardowy Standard Стандартный	6
			Duży Large Большой	6
		 Hak laminarny wąskie ostrze Laminar hook, narrow blade Крючок ламинарный узкое лезвие	Mały Small Малый	6
			Standardowy Standard Стандартный	6
			Duży Large Большой	6
		 Hak laminarny wydłużony Laminar hook, extended body Крючок ламинарный с удлиненным телом	-	2
		 Hak laminarny odsadzony Laminar hook, offset Крючок ламинарный офсетный	Prawy Right Правый	2
			Lewy Left Левый	2
		 Hak laminarny odgięte ostrze Laminar hook, angled blade Крючок ламинарный угловой	-	2
		 Hak laminarny piersiowy Thoracic laminar hook Крючок ламинарный торакальный	-	3
 Hak laminarny piersiowy wąskie ostrze Thoracic laminar hook, narrow blade Крючок ламинарный торакальный узкое лезвие	-	3		
 Hak laminarny piersiowy małe odsadzenie Thoracic laminar hook, narrow blade небольшое смещение	Prawy Right Правый	3		
	Lewy Left Левый	3		
 Hak laminarny piersiowy duże odsadzenie Thoracic laminar hook, large offset Крючок ламинарный торакальный большое смещение	Prawy Right Правый	3		
	Lewy Left Левый	3		
 Hak pedikularny Pedicule hook Крючок педикулярный	Mały Small Малый	2		
	Standardowy Standard Стандартный	2		
 Hak na wyrostek poprzeczny Transverse process hook Крючок для поперечного отростка	Prawy Right Правый	3		
	Lewy Left Левый	3		

15.0907.011	Instrumentarium do kręgosłupa CHARSPINE2 podstawowe Instrument set for CHARSPINE2 spine stabilizer - basic Инструменты для стабилизатора позвоночника CHARSPINE2 основные		
15.0907.111	Instrumentarium CHARSPINE2 moduł 1 Instrument set for CHARSPINE2 module 1 Инструменты CHARSPINE2 модуль 1	Nr katalogowy Catalogue no. № по кат.	Szt. Pcs Шт.



Pokrywa kontenera 9x4
Container lid 9x4
Покрышка для контейнера 9x4

14.0907.113 1



Kontener 9x4 H
Container 9x4H
Контейнер 9x4H

14.0907.116 1



Manipulator do śrub
Screw persuader
Манипулятор для винтов

40.8096.100 1



Trokar pedikularny piersiowy
Thoracic pedicular trocar
Троакары педикулярный грудной

40.8070.000 1



Trokar pedikularny uniwersalny
Universal pedicular trocar
Троакары педикулярный универсальный

40.8071.000 1



Trokar pedikularny prosty
Straight pedicular trocar
Троакары педикулярный прямой

40.8072.000 1



Szczypce-trzymacze
Holding forceps
Клещи держатели

40.6202.000 1



Klucz do śrub monoaksjalnych
Wrench for monoaxial screws
Ключ для моноаксиальных винтов

40.6734.000 1



Klucz do śrub poliaksjalnych
Wrench for polyaxial screws
Ключ для полиаксиальных винтов

40.6737.000 2



Wyginak do pręta regulowany
Adjustable rod bender
Выгибатель стержня регулируемый

40.8074.000 1



Rękojeść owalna ze sprzęgłem
Oval head ratchet handle

40.8086.000 2

15.0907.011	Instrumentarium do kręgosłupa CHARSPINE2 podstawowe Instrument set for CHARSPINE2 spine stabilizer - basic Инструменты для стабилизатора позвоночника CHARSPINE2 основные		
15.0907.112	Instrumentarium CHARSPINE2 moduł 2 Instrument set for CHARSPINE2 module 2 Инструменты CHARSPINE2 модуль 2	Nr katalogowy Catalogue no. № по кат.	Szt. Pcs Шт.



Kontener 9x4 H
Container 9x4H
Контейнер 9x4H

14.0907.112 1



Klucz kontrujący
Counter wrench
Ключ контрующий

40.8095.000 1



Grot T30
Screwdriver tip T30
Наконечник T30

40.8084.000 1



Wkrętak T30
Screwdriver T30
Отвертка T30

40.8111.000 1



Sonda pedikularna prosta
Pedicule probe straight
Зонд педикулярный прямой

40.6698.000 1



Sonda pedikularna wygięta
Pedicule probe curved
Зонд педикулярный изогнутый

40.6699.000 1



Szczypce kompresyjne-szczęki W-26 (komplet)
Compression forceps-jaws W-26 (set)
Компрессионные клещи-губки W-26 (комплект)

40.5768.026 1



Szczypce kompresyjne-szczęki W-46 (komplet)
Compression forceps-jaws W-46 (set)
Компрессионные клещи-губки W-46 (комплект)

40.5768.046 1





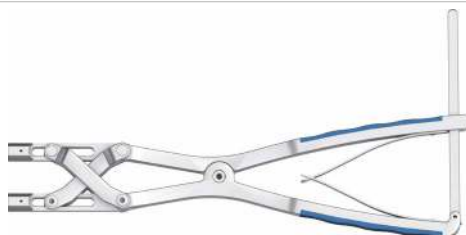

Szczypce dystrykcyjne-szczęki
Distraction forceps-jaws
Дистракционные клещи-губки

40.5769.000 1



Szczypce dystrykcyjne równoległe
Parallel distraction forceps
Дистракционные параллельные клещи

40.8093.000 1

15.0907.011	Instrumentarium do kręgosłupa CHARSPINE2 podstawowe Instrument set for CHARSPINE2 spine stabilizer - basic Инструменты для стабилизатора позвоночника CHARSPINE2 основные		
	Szczypcy kompresyjne równoległe Parallel compression forceps Компрессионные параллельные клещи	40.8094.000	1
	Trokar Троакап Trocar	40.8073.000	1
15.0907.211	Instrumentarium CHARSPINE2 moduł 4 Instrument set for CHARSPINE2 module 4 Инструменты CHARSPINE2 модуль 4	Nr katalogowy Catalogue no. № по кат.	Szt. Pcs Шт.
	Paleta 4x4 1/2H Tray 4x4 1/2H Поддон 4x4 1/2H	14.0907.211	1
	Szczypcy do pręta Pliers for rod Клещи для стержня	40.8109.000	1
	Rękojeść dynamometryczna T 12 Nm T-type torque handle 12Nm Рукоятка динамометрическая T 12Нм	40.8087.000	1

15.0907.012	Instrumentarium do kręgosłupa CHARSPINE2 dodatkowe Instrument set for CHARSPINE2 spine stabilizer - extension Инструменты для стабилизатора позвоночника CHARSPINE2 дополнительные		
15.0907.114	Instrumentarium CHARSPINE2 moduł 3 Instrument set for CHARSPINE2 module 3 Инструменты CHARSPINE2 модуль 3	Nr katalogowy Catalogue no. № по кат.	Szt. Pcs Шт.



Pokrywa kontenera 9x4
Container lid 9x4
Покрышка для контейнера 9x4

14.0907.115 1









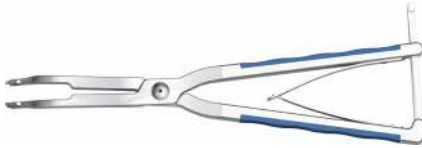

Kontener 9x4 H
Container 9x4H
Контейнер 9x4H

14.0907.114 1

	Gwintownik 4,0 Метчик 4,0 Cortical tap 4.0	40.8075.540	1
	Gwintownik 4,5 Метчик 4,5 Cortical tap 4.5	40.8075.545	1
	Gwintownik 5,0 Метчик 5,0 Cortical tap 5.0	40.8075.550	1
	Gwintownik 5,5 Метчик 5,5 Cortical tap 5.5	40.8075.555	1
	Gwintownik 6,0 Метчик 6,0 Cortical tap 6.0	40.8075.560	1
	Gwintownik 6,5 Метчик 6,5 Cortical tap 6.5	40.8075.565	1
	Gwintownik 7,5 Метчик 7,5 Cortical tap 7.5	40.8075.575	1
	Gwintownik 8,5 Метчик 8,5 Cortical tap 8.5	40.8075.585	1
	Gwintownik 9,5 Метчик 9,5 Cortical tap 9.5	40.8075.595	1
	Grot T15 Screwdriver tip T15 Наконечник T15	40.8110.000	1
	Przyrząd do śruby redukcyjnej Reduction screw device Прибор для редуционного винта	40.8108.000	1
	Wyginak do pręta 6,0 lewy Rod bender 6.0 left Выгибатель стержня 6,0 левый	40.8091.000	1
	Wyginak do pręta 6,0 prawy Rod bender 6.0 right Выгибатель стержня 6,0 правый	40.8092.000	1
	Manipulator widelkowy Fork persuader Манипулятор вилковый	40.8100.000	1
	Klucz oczkowy Eye wrench Ключ гаечный	40.8069.000	1
	Doruchacz pręta Rod impactor Толкатель стержня	40.8068.000	1

15.0907.012	Instrumentarium do kręgosłupa CHARSPINE2 dodatkowe Instrument set for CHARSPINE2 spine stabilizer - extension Инструменты для стабилизатора позвоночника CHARSPINE2 дополнительные		
15.0907.212	Instrumentarium CHARSPINE2 moduł 5 Instrument set for CHARSPINE2 module 5 Инструменты CHARSPINE2 модуль 5	Nr katalogowy Catalogue no. № по кат.	Szt. Pcs Шт.
	Paleta 4x4 1/2H Tray 4x4 1/2H Поддон 4x4 1/2H	14.0907.212	1
	Chwytnik do łączników poprzecznych Holder for crosswise connectors Захват для поперечных соединителей	40.8067.000	1
	Chwytnik do łączników prętowych Holder for rod connectors Захват для соединителей стержней	40.8076.000	1
	Rękojeść dynamometryczna T 3,5 Nm T-type torque handle 3.5Nm Рукятка динамометрическая Т 3,5Нм	40.8088.000	1
	Wzorzec Измеритель Template	40.5248.000	1

15.0907.002	Instrumentarium do kręgosłupa CHARSPINE2 rozszerzenie 1 (narzędzia do haków kręgosłupowych) Instrument set for CHARSPINE2 spine stabilizer - extended 1 (instruments for spine hooks) Инструменты для стабилизатора позвоночника CHARSPINE2 расширенные 1 (инструменты для крючков позвоночных)	Nr katalogowy Catalogue no. № по кат.	Szt. Pcs Шт.
15.0907.203	Instrumentarium CHARSPINE2 moduł 6 Instrument set for CHARSPINE2 module 6 Инструменты CHARSPINE2 модуль 6	14.0907.203	1
	 <p>Paleta 5x4 1/2H Tray 5x4 1/2H Поддон 5x4 1/2H</p>		
	 <p>Chwytek do haków Hook holder Захват для крючков</p>	40.8101.000	1
	 <p>Chwytek do haków boczny Lateral hook holder Захват для крючков латеральный</p>	40.8102.000	1
15.0907.204	Instrumentarium CHARSPINE2 moduł 7 Instrument set for CHARSPINE2 module 7 Инструменты CHARSPINE2 модуль 7	Nr katalogowy Catalogue no. № по кат.	Szt. Pcs Шт.
	 <p>Paleta 5x4 1/2H Tray 5x4 1/2H Поддон 5x4 1/2H</p>	14.0907.204	1
	 <p>Impaktor do haków Impactor for hooks Импактор для крючков</p>	40.8103.000	1
	 <p>Preparator do haków laminarnych wąski Narrow raspatory for laminar hooks Распатор для ламинарных крючков узкий</p>	40.8104.000	1
	 <p>Preparator do haków laminarnych Raspatory for laminar hooks Распатор для ламинарных крючков</p>	40.8105.000	1
	 <p>Preparator do haków laminarnych szeroki Wide raspatory for laminar hooks Распатор для ламинарных крючков широкий</p>	40.8106.000	1
	 <p>Preparator do haków pedikularnych Raspatory for pedicle hooks Распатор для педикулярных крючков</p>	40.8107.000	1









Instrumentarium rozszerzające [15.0907.002] stanowi wyposażenie ponadstandardowe. Extended instrument set [15.0907.002] is additional equipment. Инструменты расширенные [15.0907.002] являются дополнительным оснащением.
 W celu dołączenia go do zamawianego instrumentarium CHARSPINE2, proszę skontaktować się z lokalnym przedstawicielem lub Działem sprzedaży firmy ChM. In order to include the instruments to the ordered CHARSPINE2 instruments, please contact your local representative or ChM Sales Department. Для их заказа следует обратиться к местному представителю или к Отделу продаж компании ChM.

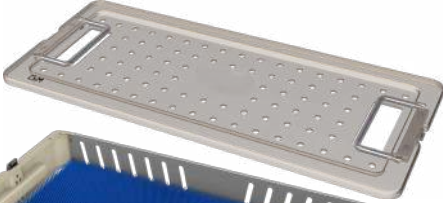

Przedstawione poniżej narzędzia stanowią wyposażenie ponadstandardowe. Instruments mentioned below are not included in the standard instrument set. Нижепредставленные инструменты являются дополнительным оснащением.
 W celu dołączenia poszczególnych narzędzi do zamawianego instrumentarium CHARSPINE2, proszę skontaktować się z lokalnym przedstawicielem lub Działem sprzedaży firmy ChM. In order to include them to the ordered CHARSPINE2 instruments, please contact your local representative or ChM Sales Department. Для их заказа необходимо связаться с местным представителем или с Отделом продаж компании ChM.

Narzędzia ponadstandardowe Дополнительные инструменты Supplementary instruments		Nr katalogowy Catalogue no. № по кат.
	Manipulator do śrub Screw persuader Манипулятор для винтов	40.8083.100
	Przymiar pręta 6/300 Rod trial 6/300 Мера стержня 6/300	40.5246.300
	Sonda pedikularna Pedicel probe Зонд педикулярный	40.6696.000
	Wyginak do pręta rurowy (2 szt.) Tubular rod bender (2 pcs.) Выгибатель стержня трубчатый(2 шт.)	40.6178.000
	Szczypsc dystrakcyjne Distraction forceps Клещи дистракционные	40.6176.000
	Szczypsc kompresyjne Compression forceps Клещи компрессионные	40.6694.000
	Wkrętak T30 krótki Screwdriver T30 short Отвертка T30 короткая	40.6151.100

Narzędzia ponadstandardowe Дополнительные инструменты Supplementary instruments		
	Nazwa Name Название	Nr katalogowy Catalogue no. № по кат.
	Trokar pedicularny piersiowy Thoracic pedicular trocar Троакар педикулярный грудной	40.6243.000
	Trokar pedicularny uniwersalny Universal pedicular trocar Троакар педикулярный универсальный	40.6244.000
	Trokar pedicularny prosty Straight pedicular trocar Троакар педикулярный прямой	40.6245.000
	Nożyce gilotynowe do pręta Hand hold rod cutter Гилиотинные ножницы для стержня	40.5288.000
	Pokrywa kontenera 9x4 Container lid 9x4 Покрышка для контейнера 9x4	14.0907.106
	Kontener 9x4H Container 9x4H Контейнер 9x4H	14.0907.105

Narzędzia ponadstandardowe do procedury podania cementu kostnego z dostępu otwartego
Additional instruments, not included in the set, for bone cement delivery through an open access
Дополнительные инструменты для процедуры подачи костного цемента с открытым доступом

Nazwa
 Name
 Название





Nr katalogowy
 Catalogue no.
 № по кат.

Szt.
 Pcs
 Шт.



W celu dołączenia poniższych narzędzi do instrumentarium CHARSPINE2, proszę skontaktować się z lokalnym przedstawicielem lub Działem sprzedaży firmy ChM.
 In order to include them to the ordered CHARSPINE2 instruments, please contact your local representative or ChM Sales Department.

Для добавления отдельных инструментов к заказываемому набору инструментов CHARSPINE2, обратитесь, пожалуйста, к местному представителю или в Отдел продаж компании ChM.

	Kaniula do cementu kostnego Cannula for bone cement Канюля для костного цемента	40.8591.000	1
	Przymiar wyrównujący do kaniuli Alignment trial for cannula Мера выравнивающая для канюли	40.8592.000	1
	Popychacz Pusher Толкатель	40.8596.000	1
	Klucz kontrolujący Counter wrench Ключ контролирующий	40.6749.000	1

Instrumentarium podstawowe [15.0907.111]
Containers for basic instrument set [15.0907.111]
Инструменты основные [15.0907.111]

Lp. No. №	Nazwa Name Название	Nr katalogow Catalogue No. № по кат.	Szt. Pcs Шт.
1	Pokrywa kontenera 9x4 Container lid 9x4 Покрышка для контейнера 9x4	14.0907.113	1
2	Kontener 9x4H Container 9x4H Контейнер 9x4H	14.0907.116	1
3	Paleta 4x4 1/2 Tray 4x4 1/2 Поддон 4x4 1/2H	14.0907.211	1
4	Paleta Tray Поддон 4x4 1/2H	14.0907.112	1

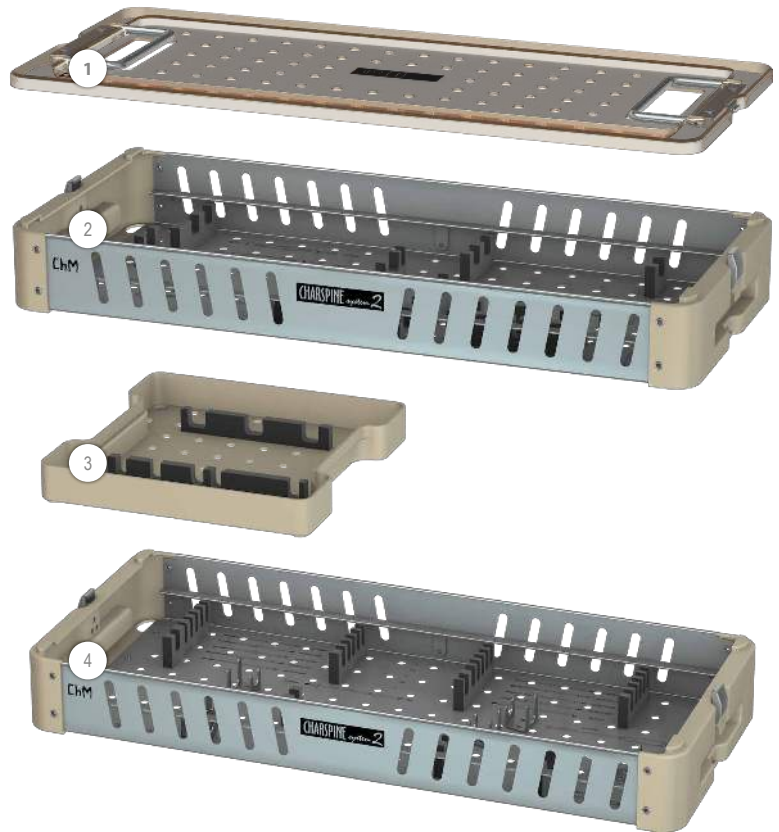

Instrumentarium rozszerzone 15.0907.012
Инструменты расширенные [15.0907.012]
Containers for extended instrument [15.0907.012]

Lp. No. №	Nazwa Name Название	Nr katalogow Catalogue No. № по кат.	Szt. Pcs Шт.
1	Pokrywa kontenera 9x4 Container lid 9x4 Покрышка для контейнера 9x4	14.0907.115	1
2	Paleta 4x4 1/2H Tray 4x4 1/2H Поддон 4x4 1/2H	14.0907.212	1
3	Kontener 9x4H Container 9x4H Контейнер 9x4H	14.0907.114	1

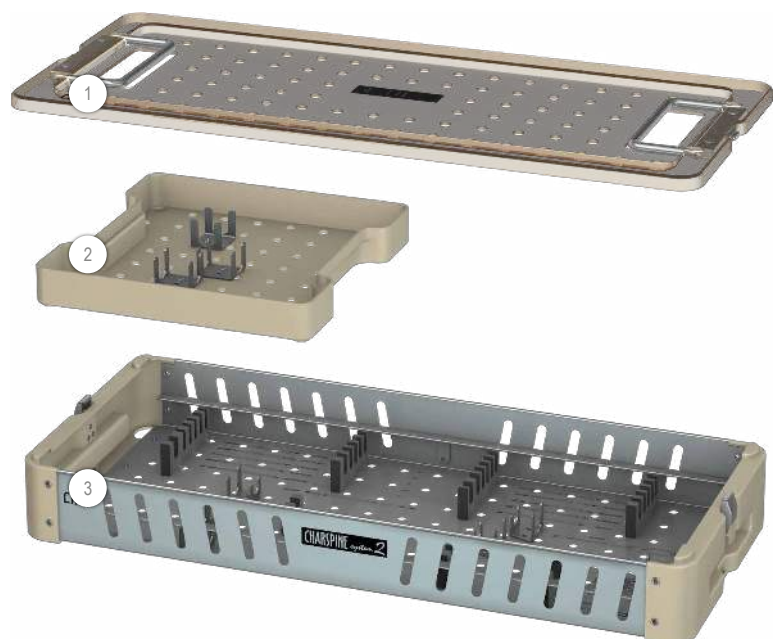

Instrumentarium rozszerzone [15.0907.002]
Containers for extended instrument [15.0907.002]
Инструменты расширенные [15.0907.002]

Опция I
Option I
Опция I

Lp. No. №	Nazwa Name Название	Nr katalogow Catalogue No. № по кат.	Szt. Pcs Шт.
1	Instrumentarium do kręgosłupa CHAR-SPINE2 podstawowe Instrument set for CHARSPINE2 spine stabilizer - basic Инструменты для стабилизатора позвоночника CHARSPINE2 основные	15.0907.011	1
2	Paleta 5x4 1/2H Tray 5x4 1/2H Поддон 5x4 1/2H	14.0907.203	1
3	Instrumentarium do kręgosłupa CHAR-SPINE2 dodatkowe Instrument set for CHARSPINE2 spine stabilizer - extension Инструменты для стабилизатора позвоночника CHARSPINE2 дополнительные	15.0907.012	1
4	Paleta 5x4 1/2H Tray 5x4 1/2H Поддон 5x4 1/2H	14.0907.204	1

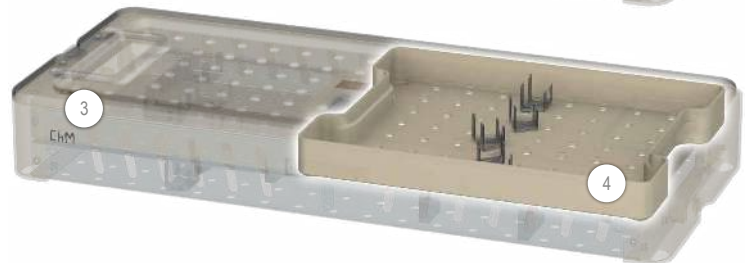
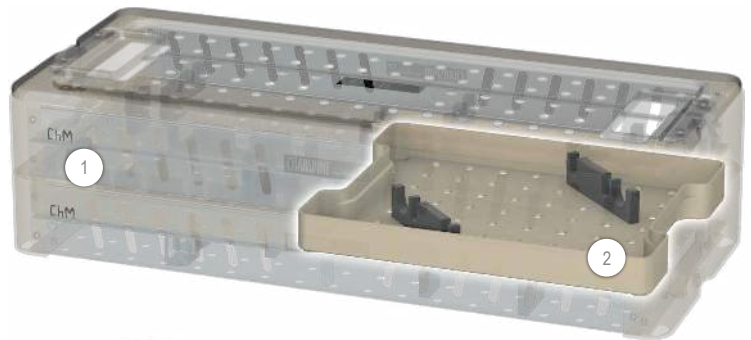

Опция II
Option II
Опция II

(w przypadku nieposiadania Instrumentarium rozszerzonego 15.0907.012)
(In case extended Instrument set 15.0907.012 has not been purchased)
(при отсутствии инструментария расширенного 15.0907.012)

Lp. No. №	Nazwa Name Название	Nr katalogow Catalogue No. № по кат.	Szt. Pcs Шт.
1	Pokrywa aluminiowa perfor.1/1 595x275x15mm Szara Perforated aluminum lid 1/1 595x275x15mm Gray Покрышка алюминиевая перфорированная 1/1 595x275x15mm Серая	12.0750.200	1
2	Paleta 5x4 1/2H Tray 5x4 1/2H Поддон 5x4 1/2H	14.0907.203	1
3	Paleta 5x4 1/2H Tray 5x4 1/2H Поддон 5x4 1/2H	14.0907.204	1
4	Kontener z litym dnem 1/1 595x275x86mm Container with solid bottom 1/1 595x275x86mm Контейнер со сплошным дном 1/1 595x275x86мм	12.0750.100	1

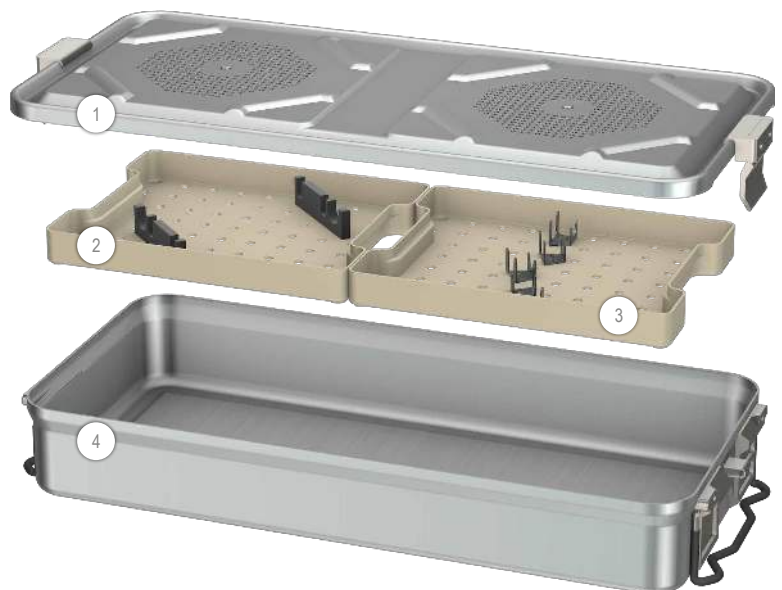

Przeznaczona do stosowania z drutem Kirschnera o średnicy 1,5mm.
The screw is intended for use with a Kirschner wire of a 1.5 mm diameter.
Предназначена для применения со спицей Киршнером диаметром 1,5мм.



Fenestracje do wstrzyknięcia cementu
Fenestrations for cement injection
Боковые отверстия для инъекции цемента

CHARSPINE2 WKREŃ BLOKUJĄCY
CHARSPINE2 LOCKING SCREW
CHARSPINE2 ВИНТ ЗАЖИМНОЙ



3.6160.000 ✓

Ø4.5 Ø5.0 Ø5.5 Ø6.0 Ø6.5 Ø7.0 Ø7.5 Ø8.5 Ø9.5 Ø10.5



	Len	Ti		Len	Ti
4.5	30	3.6565.030	8.5	30	3.6572.030
	35	3.6565.035		35	3.6572.035
	40	3.6565.040		40	3.6572.040
	45	3.6565.045		45	3.6572.045
5.0	30	3.6566.030	9.5	50	3.6572.050
	35	3.6566.035		55	3.6572.055
	40	3.6566.040		60	3.6572.060
	45	3.6566.045		65	3.6572.065
5.5	30	3.6567.030	10.5	70	3.6572.070
	35	3.6567.035		75	3.6572.075
	40	3.6567.040		80	3.6572.080
	45	3.6567.045		85	3.6572.085
	50	3.6567.050		90	3.6572.090
	55	3.6567.055		95	3.6572.095
6.0	60	3.6567.060	10.5	100	3.6572.100
	65	3.6567.065		30	3.6573.030
	30	3.6568.030		35	3.6573.035
	35	3.6568.035		40	3.6573.040
	40	3.6568.040		45	3.6573.045
	45	3.6568.045		50	3.6573.050
6.5	50	3.6568.050	10.5	55	3.6573.055
	55	3.6568.055		60	3.6573.060
	60	3.6568.060		65	3.6573.065
	65	3.6568.065		70	3.6573.070
	30	3.6569.030		75	3.6573.075
	35	3.6569.035		80	3.6573.080
7.0	40	3.6569.040	10.5	85	3.6573.085
	45	3.6569.045		90	3.6573.090
	50	3.6569.050		95	3.6573.095
	55	3.6569.055		100	3.6573.100
	60	3.6569.060		30	3.6574.030
	65	3.6569.065		35	3.6574.035
7.5	30	3.6570.030	10.5	40	3.6574.040
	35	3.6570.035		45	3.6574.045
	40	3.6570.040		50	3.6574.050
	45	3.6570.045		55	3.6574.055
	50	3.6570.050		60	3.6574.060
	55	3.6570.055		65	3.6574.065
8.5	60	3.6570.060	10.5	70	3.6574.070
	65	3.6570.065		75	3.6574.075
	30	3.6571.030		80	3.6574.080
	35	3.6571.035		85	3.6574.085
	40	3.6571.040		90	3.6574.090
	45	3.6571.045		95	3.6574.095
9.5	50	3.6571.050	10.5	100	3.6574.100
	55	3.6571.055		30	3.6575.030
	60	3.6571.060		35	3.6575.035
	65	3.6571.065		40	3.6575.040
	70	3.6571.070		45	3.6575.045
	75	3.6571.075		50	3.6575.050
10.5	80	3.6571.080	10.5	55	3.6575.055
	85	3.6571.085		60	3.6575.060
	90	3.6571.090		65	3.6575.065
				70	3.6575.070
				75	3.6575.075
				80	3.6575.080



Len	Ti
30	3.6900.030
35	3.6900.035
40	3.6900.040
45	3.6900.045
50	3.6900.050
55	3.6900.055
60	3.6900.060
65	3.6900.065
70	3.6900.070
75	3.6900.075
80	3.6900.080
85	3.6900.085
90	3.6900.090
95	3.6900.095
100	3.6900.100
110	3.6900.110
120	3.6900.120
130	3.6900.130
140	3.6900.140
150	3.6900.150
160	3.6900.160
170	3.6900.170
180	3.6900.180
190	3.6900.190
200	3.6900.200
300	3.6900.300
400	3.6900.400
500	3.6900.500
600	3.6900.600

CHARSPINE2 MIS PRĘT TWARDY 6
 CHARSPINE2 MIS Hard rod 6
 CHARSPINE2 MIS СТЕРЖЕНЫ ТВЁРДЫЙ 6



Len	Co
30	4.6900.030
35	4.6900.035
40	4.6900.040
45	4.6900.045
50	4.6900.050
55	4.6900.055
60	4.6900.060
65	4.6900.065
70	4.6900.070
75	4.6900.075
80	4.6900.080
85	4.6900.085
90	4.6900.090
95	4.6900.095
100	4.6900.100
110	4.6900.110
120	4.6900.120
130	4.6900.130
140	4.6900.140
150	4.6900.150
160	4.6900.160
170	4.6900.170
180	4.6900.180
190	4.6900.190
200	4.6900.200
300	4.6900.300
400	4.6900.400
500	4.6900.500
600	4.6900.600

CHARSPINE2 MIS PRĘT ZAKRZYWIONY 6
 CHARSPINE2 MIS CURVED ROD 6
 CHARSPINE2 MIS СТЕРЖЕНЬ ИЗОГНУТЫЙ 6



















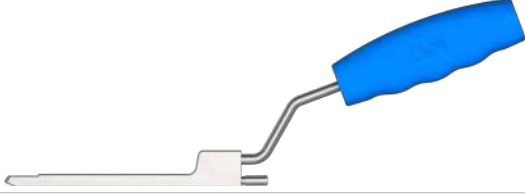



Len	Ti
30	3.6901.030
35	3.6901.035
40	3.6901.040
45	3.6901.045
50	3.6901.050
55	3.6901.055
60	3.6901.060
65	3.6901.065
70	3.6901.070
75	3.6901.075
80	3.6901.080
85	3.6901.085
90	3.6901.090
95	3.6901.095
100	3.6901.100
110	3.6901.110
120	3.6901.120
130	3.6901.130
140	3.6901.140
150	3.6901.150
160	3.6901.160
170	3.6901.170
180	3.6901.180
190	3.6901.190
200	3.6901.200



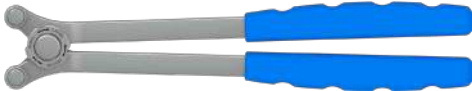





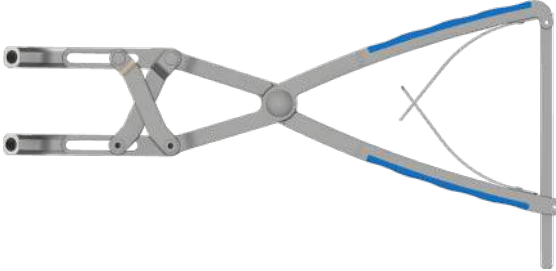
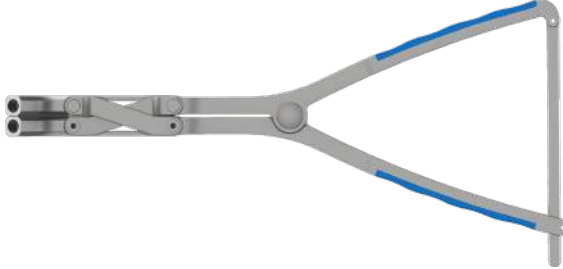

CHARSPINE2 MIS PRĘT ZAKRZYWIONY TWARDY 6
 CHARSPINE2 MIS CURVED HARD ROD 6
 CHARSPINE2 MIS СТЕРЖЕНЬ ИЗОГНУТЫЙ ТВЁРДЫЙ 6













Len	Co
30	4.6901.030
35	4.6901.035
40	4.6901.040
45	4.6901.045
50	4.6901.050
55	4.6901.055
60	4.6901.060
65	4.6901.065
70	4.6901.070
75	4.6901.075
80	4.6901.080
85	4.6901.085
90	4.6901.090
95	4.6901.095
100	4.6901.100
110	4.6901.110
120	4.6901.120
130	4.6901.130
140	4.6901.140
150	4.6901.150
160	4.6901.160
170	4.6901.170
180	4.6901.180
190	4.6901.190
200	4.6901.200

Instrumentarium CHARSPINE2 MIS podstawowe			
15.0913.101	CHARSPINE2 MIS Instrument set - basic CHARSPINE2 MIS инструменты основные		
Instrumentarium CHARSPINE2 MIS CHARSPINE2 MIS Instrument set CHARSPINE2 MIS инструменты		Szt. Pcs Шт.	
		Nr katalogowy Catalogue no. № по кат.	
	Kontener 9x4H Container 9x4H Контейнер 9x4H	1	14.0913.101
	Tuleja ochronna I Protective guide I Втулка защитная I	1	40.8562.000
	Tuleja ochronna II Protective guide II Втулка защитная II	1	40.8563.000
	Tuleja ochronna III Protective guide III Втулка защитная III	1	40.8564.000
	Tuleja ochronna IV Protective guide IV Втулка защитная IV	1	40.8588.000
	Trokar Тросар Троакар	1	40.8561.000
	Wkrętak T30 Screwdriver T30 Отвертка T30	1	40.8574.000
	Wkrętak T30 Screwdriver T30 Отвертка T30	1	40.8111.000
	Aplikator Applicator Апликатор	1	40.8571.000
	Aplikator Applicator Апликатор	1	40.8572.000

Instrumentarium CHARSPINE2 MIS podstawowe 15.0913.101 CHARSPINE2 MIS Instrument set - basic CHARSPINE2 MIS инструменты основные		
Instrumentarium CHARSPINE2 MIS CHARSPINE2 MIS Instrument set CHARSPINE2 MIS инструменты	Szt. Pcs Шт.	Nr katalogowy Catalogue no. № по кат.
	1	14.0913.102
Kontener 9x4H Container 9x4H Контейнер 9x4H		
	2	40.8086.000
Rękojeść owalna ze sprzęgłem Рукоятка овальная со сцеплением Oval head ratchet handle		
	1	40.8565.000
Rozwiertak ręczny kaniulowany Manual cannulated reamer Сверло ручное каниюлированное		
	1	40.8570.000
Przymiar Gauge Мера		
	1	40.8566.000
Raszpla Bone rasp Рашпиль		
	1	40.8074.000
Wyginak do pręta regulowany Adjustable rod bender Выгибатель стержня регулируемый		
	2	40.8568.000
Klucz do śrub poliaksjalnych Wrench for polyaxial screws Ключ для полиаксиальных винтов		
	2	40.5246.300
Przymiar pręta 6/300 Rod trial 6/300 Мера стержня 6/300		
	1	14.0913.103
Kontener Container Контейнер 9x4H		
	1	40.8084.000
Grot Screwdriver tip Наконечник T30		
	1	40.8578.000
Płytko do repozycji Reposition plate Пластина для репозиции		

Instrumentarium CHARSPINE2 MIS podstawowe 15.0913.101 CHARSPINE2 MIS Instrument set - basic CHARSPINE2 MIS инструменты основные		Szt. Pcs Шт.	Nr katalogowy Catalogue no. № по кат.
 <p>Szczypce kompresyjne równoległe Parallel compression forceps Клещи компрессионные параллельные</p>		1	40.8576.000
 <p>Szczypce dystrykcyjne równoległe Parallel distraction forceps Клещи дистракционные параллельные</p>		1	40.8577.000
 <p>Rękojeść dynamometryczna T 12 Nm T-type torque handle 12Nm Рукоятка динамометрическая T 12Нм</p>		1	40.8087.000
 <p>Paleta 9x4 1/2H Tray 9x4 1/2H Поддон 9x4 1/2H</p>		1	14.0913.201
 <p>Gwintownik 4,5 Cortical tap 4.5 Метчик 4,5</p>		1	40.8567.045
 <p>Gwintownik 5,0 Cortical tap 5.0 Метчик 5,0</p>		1	40.8567.050
 <p>Gwintownik 5,5 Cortical tap 5.5 Метчик 5,5</p>		1	40.8567.055
 <p>Gwintownik 6,0 Cortical tap 6.0 Метчик 6,0</p>		1	40.8567.060
 <p>Gwintownik 6,5 Cortical tap 6.5 Метчик 6,5</p>		1	40.8567.065
 <p>Gwintownik 7,0 Cortical tap 7.0 Метчик 7,0</p>		1	40.8567.070
 <p>Gwintownik 7,5 Cortical tap 7.5 Метчик 7,5</p>		1	40.8567.075
 <p>Gwintownik 8,5 Cortical tap 8.5 Метчик 8,5</p>		1	40.8567.085

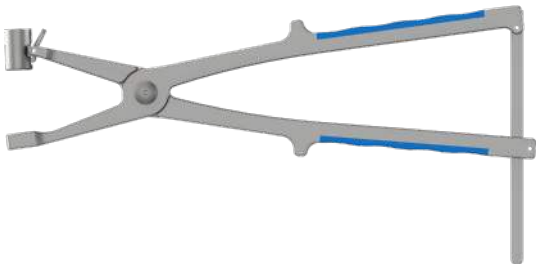
Instrumentarium CHARSPINE2 MIS podstawowe 15.0913.101 CHARSPINE2 MIS Instrument set - basic CHARSPINE2 MIS инструменты основные			Szt. Pcs Шт.	Nr katalogowy Catalogue no. № по кат.
Instrumentarium CHARSPINE2 MIS CHARSPINE2 MIS Instrument set CHARSPINE2 MIS инструменты				
	Gwintownik 9,5 Cortical tap 9.5 Метчик 9,5		1	40.8567.095
	Gwintownik 10,5 Cortical tap 10.5 Метчик 10,5		1	40.8567.105
	Statyw Stand Подставка		1	40.8590.000
	Drut prowadzący 1,5/500 Guide rod 1.5/500 Спица-направитель 1,5/500		10	40.8560.000
	Pokrywa kontenera 9x4 Container lid 9x4 Покрышка для контейнера 9x4		1	14.0913.104

Instrumentarium CHARSPINE2 MIS dodatkowe 1 15.0913.202 CHARSPINE2 MIS Instrument set - additional 1 CHARSPINE2 MIS инструменты дополнительные 1		Szt. Pcs Шт.	Nr katalogowy Catalogue no. № по кат.
 <p>Paleta 9x4 1/2H Tray 9x4 1/2H Поддон 9x4 1/2H</p>		1	14.0913.202
 <p>Klucz kontrolujący Counter wrench Ключ контролирующий</p>		1	40.8579.000
 <p>Tuleja II Guide II Втулка II</p>		2	40.8575.000
 <p>Klucz Wrench Ключ</p>		1	40.8580.000
 <p>Dopychacz pręta Rod impactor Толкатель стержня</p>		1	40.8573.000
 <p>Tuleja prowadząca Guide sleeve Втулка направляющая</p>		10	40.8569.000

Przedstawione poniżej narzędzia stanowią wyposażenie ponadstandardowe.
Instruments mentioned below are not included in the standard instrument set.











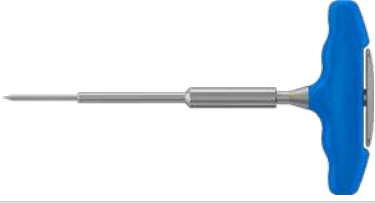

Нижеуказанные инструменты являются дополнительным оснащением.

W celu dołączenia poszczególnych narzędzi do zamawianego instrumentarium CHARSPINE2, proszę skontaktować się z lokalnym przedstawicielem lub Działem sprzedaży firmy ChM.

In order to include them to the ordered CHARSPINE2 instruments, please contact your local representative or ChM Sales Department.

Для их заказа, обратитесь, пожалуйста, к местному представителю или к Отделу продаж компании ChM.



	Nazwa Name Название	Szt. Pcs Шт.	Nr katalogowy Catalogue no. № по кат.
	Kaniula do cementu kostnego Cannula for bone cement Канюля для костного цемента	1	40.8591.000
	Przymiar wyrównujący do kaniuli Alignment trial for cannula Мера выравнивающая для канюли	1	40.8592.000
	Trokar Trocar Троакар	1	40.8601.000
	Łącznik Connector Соединитель	1	40.8595.000
	Drut prowadzący 1,5/500 Guide rod 1.5/500 Спица-направитель 1,5/500	1	40.8560.000
	Drut prowadzący 1,5/500 Guide rod 1.5/500 Спица-направитель 1,5/500	1	40.8558.000
	Drut prowadzący 1,5/500 Guide rod 1.5/500 Спица-направитель 1,5/500	1	40.8557.000
	Drut prowadzący 1,5/600 Guide rod 1.5/600 Спица-направитель 1,5/600	1	40.8559.600
	Drut prowadzący 1,5/600 Guide rod 1.5/600 Спица-направитель 1,5/600	1	40.8560.600
	Drut prowadzący 1,5/600 Guide rod 1.5/600 Спица-направитель 1,5/600	1	40.8558.600
	Drut prowadzący 1,5/600 Guide rod 1.5/600 Спица-направитель 1,5/600	1	40.8557.600
	Kontener Container Контейнер	1	40.8555.000
	Wzorzec głębokości Depth measure Измеритель глубины	1	40.8586.000

KONTENERY NA INSTRUMENTARIUM PODSTAWOWE [15.0913.101] I INSTRUMENTARIUM DODATKOWE [15.0913.202]
 CONTAINERS FOR BASIC INSTRUMENT SET [15.0913.101] AND ADDITIONAL INSTRUMENTS [15.0913.202]
 КОНТЕЙНЕРЫ ДЛЯ ОСНОВНОГО НАБОРА ИНСТРУМЕНТОВ [15.0913.101] И ИНСТРУМЕНТОВ ДОПОЛНИТЕЛЬНЫХ [15.0913.202]

Lp. No. №	Nazwa Name Название	Nr katalogow Catalogue No. № по кат.	Szt. Pcs Шт.
1	Pokrywa kontenera 9x4 Container lid 9x4 Покрышка для контейнера 9x4	14.0913.104	2
2	Paleta 9x4 1/2H Tray 9x4 1/2H Поддон 9x4 1/2H	14.0913.201	1
3	Kontener 9x4H Container 9x4H Контейнер 9x4H	14.0913.101	1
4	Paleta 9x4 1/2H Tray 9x4 1/2H Поддон 9x4 1/2H	14.0913.202	1
5	Kontener 9x4H Container 9x4H Контейнер 9x4H	14.0913.103	1
6	Kontener 9x4H Container 9x4H Контейнер 9x4H	14.0913.102	1



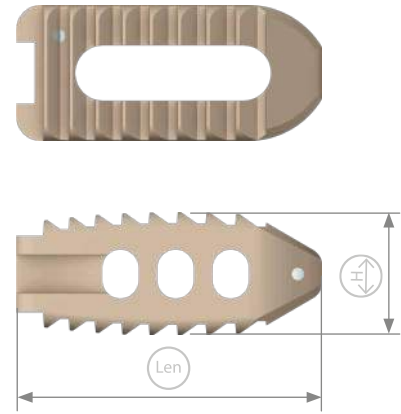
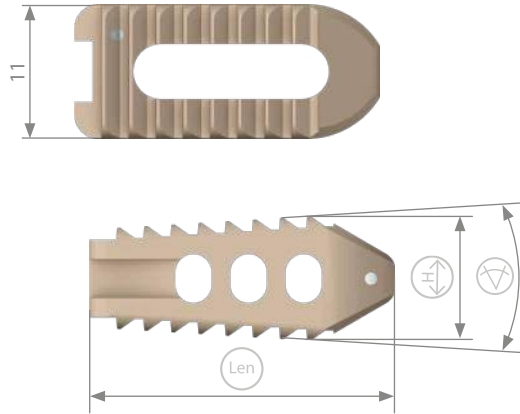

Lordyczny Lordic Лордический



0° 4° 7°

Len	H	Peek	Peek	Peek
20	9	8.3988.009	8.3988.409	8.3988.709
	10	8.3988.010	8.3988.410	8.3988.710
	11	8.3988.011	8.3988.411	8.3988.711
	12	8.3988.012	8.3988.412	8.3988.712
	13	8.3988.013	8.3988.413	8.3988.713
	14	8.3988.014	8.3988.414	8.3988.714
	15	8.3988.015	8.3988.415	8.3988.715
	16	8.3988.016	8.3988.416	8.3988.716
	17	8.3988.017	8.3988.417	8.3988.717
	18	8.3988.018	8.3988.418	8.3988.718
25	9	8.3989.009	8.3989.409	8.3989.709
	10	8.3989.010	8.3989.410	8.3989.710
	11	8.3989.011	8.3989.411	8.3989.711
	12	8.3989.012	8.3989.412	8.3989.712
	13	8.3989.013	8.3989.413	8.3989.713
	14	8.3989.014	8.3989.414	8.3989.714
	15	8.3989.015	8.3989.415	8.3989.715
	16	8.3989.016	8.3989.416	8.3989.716
	17	8.3989.017	8.3989.417	8.3989.717
	18	8.3989.018	8.3989.418	8.3989.718

Wypukły Convex Выпуклый

Len	H	Peek	Peek
20	9	8.3988.909	8.3988.909
	10	8.3988.910	8.3988.910
	11	8.3988.911	8.3988.911
	12	8.3988.912	8.3988.912
	13	8.3988.913	8.3988.913
	14	8.3988.914	8.3988.914
	15	8.3988.915	8.3988.915
	16	8.3988.916	8.3988.916
	17	8.3988.917	8.3988.917
	18	8.3988.918	8.3988.918
25	9	8.3989.909	8.3989.909
	10	8.3989.910	8.3989.910
	11	8.3989.911	8.3989.911
	12	8.3989.912	8.3989.912
	13	8.3989.913	8.3989.913
	14	8.3989.914	8.3989.914
	15	8.3989.915	8.3989.915
	16	8.3989.916	8.3989.916
	17	8.3989.917	8.3989.917
	18	8.3989.918	8.3989.918

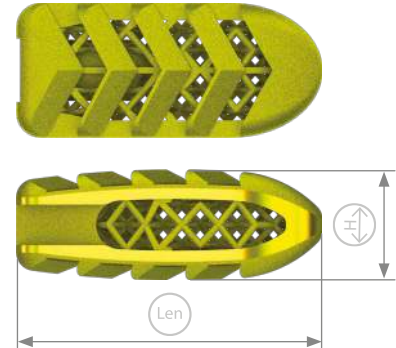
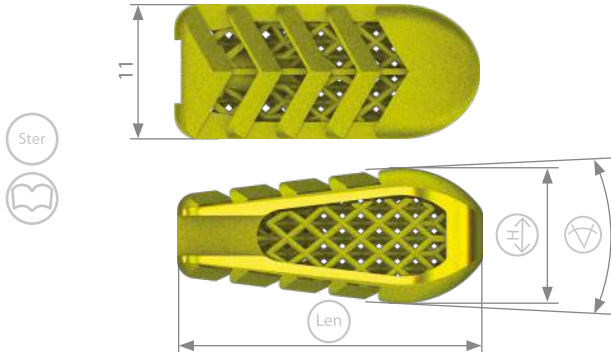

Lordyczny Lordic Лордический

Len	H	Lordosis Angle (°)				
		0°	4°	7°	14°	
20	8	8	3.6925.008S	3.6925.408S	3.6925.708S	-
		9	3.6925.009S	3.6925.409S	3.6925.709S	3.6925.149S
		10	3.6925.010S	3.6925.410S	3.6925.710S	3.6925.140S
		11	3.6925.011S	3.6925.411S	3.6925.711S	3.6925.141S
		12	3.6925.012S	3.6925.412S	3.6925.712S	3.6925.142S
		13	3.6925.013S	3.6925.413S	3.6925.713S	3.6925.143S
		14	3.6925.014S	3.6925.414S	3.6925.714S	3.6925.144S
		15	3.6925.015S	3.6925.415S	3.6925.715S	3.6925.145S
		16	3.6925.016S	3.6925.416S	3.6925.716S	3.6925.146S
		17	3.6925.017S	3.6925.417S	3.6925.717S	3.6925.147S
25	8	8	3.6926.008S	3.6926.408S	3.6926.708S	-
		9	3.6926.009S	3.6926.409S	3.6926.709S	-
		10	3.6926.010S	3.6926.410S	3.6926.710S	3.6926.140S
		11	3.6926.011S	3.6926.411S	3.6926.711S	3.6926.141S
		12	3.6926.012S	3.6926.412S	3.6926.712S	3.6926.142S
		13	3.6926.013S	3.6926.413S	3.6926.713S	3.6926.143S
		14	3.6926.014S	3.6926.414S	3.6926.714S	3.6926.144S
		15	3.6926.015S	3.6926.415S	3.6926.715S	3.6926.145S
		16	3.6926.016S	3.6926.416S	3.6926.716S	3.6926.146S
		17	3.6926.017S	3.6926.417S	3.6926.717S	3.6926.147S
18	3.6926.018S	3.6926.418S	3.6926.718S	3.6926.148S		

KĄT LORDOZY
LORDOSIS ANGLE
УГОЛ ЛОРДОЗА

Wyukły Convex Выпуклый

Len	H	Ti			
		Len	Ti		
20	8	8	3.6925.908S		
		9	3.6925.909S		
		10	3.6925.910S		
		11	3.6925.911S		
		12	3.6925.912S		
		13	3.6925.913S		
		14	3.6925.914S		
		15	3.6925.915S		
		16	3.6925.916S		
		17	3.6925.917S		
		18	3.6925.918S		
		25	8	8	3.6926.908S
				9	3.6926.909S
				10	3.6926.910S
				11	3.6926.911S
				12	3.6926.912S
				13	3.6926.913S
				14	3.6926.914S
15	3.6926.915S				
16	3.6926.916S				
17	3.6926.917S				
18	3.6926.918S				
30	8			8	3.6927.908S
				9	3.6927.909S
				10	3.6927.910S
				11	3.6927.911S
				12	3.6927.912S
				13	3.6927.913S
				14	3.6927.914S
		15	3.6927.915S		
		16	3.6927.916S		
		17	3.6927.917S		
		18	3.6927.918S		

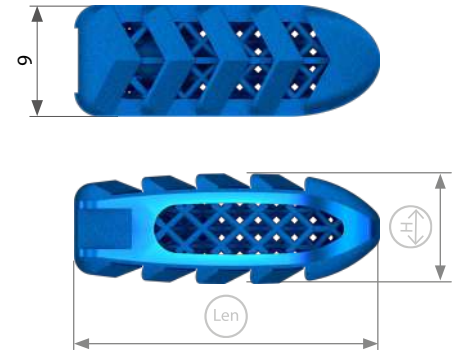
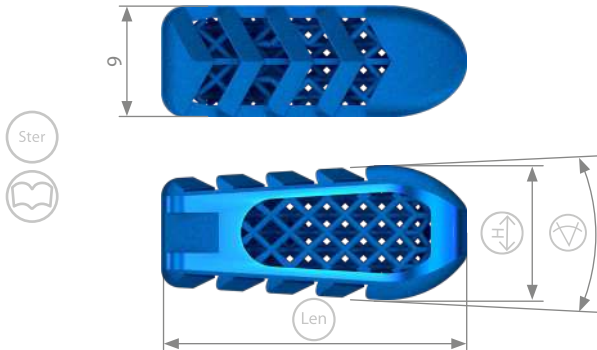

Lordyczny Lordic Лордический

Len	H	Ti			
		0°	4°	7°	14°
20	8	3.8127.008S	3.8127.408S	3.8127.708S	-
	9	3.8127.009S	3.8127.409S	3.8127.709S	3.8127.149S
	10	3.8127.010S	3.8127.410S	3.8127.710S	3.8127.140S
	11	3.8127.011S	3.8127.411S	3.8127.711S	3.8127.141S
	12	3.8127.012S	3.8127.412S	3.8127.712S	3.8127.142S
	13	3.8127.013S	3.8127.413S	3.8127.713S	3.8127.143S
	14	3.8127.014S	3.8127.414S	3.8127.714S	3.8127.144S
	15	3.8127.015S	3.8127.415S	3.8127.715S	3.8127.145S
	16	3.8127.016S	3.8127.416S	3.8127.716S	3.8127.146S
25	17	3.8127.017S	3.8127.417S	3.8127.717S	3.8127.147S
	18	3.8127.018S	3.8127.418S	3.8127.718S	3.8127.148S
	8	3.8128.008S	3.8128.408S	3.8128.708S	-
	9	3.8128.009S	3.8128.409S	3.8128.709S	-
	10	3.8128.010S	3.8128.410S	3.8128.710S	3.8128.140S
	11	3.8128.011S	3.8128.411S	3.8128.711S	3.8128.141S
	12	3.8128.012S	3.8128.412S	3.8128.712S	3.8128.142S
	13	3.8128.013S	3.8128.413S	3.8128.713S	3.8128.143S
	14	3.8128.014S	3.8128.414S	3.8128.714S	3.8128.144S







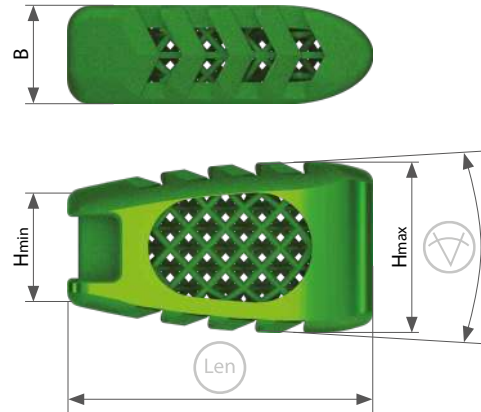

KAT LORDOZY
LORDOSIS ANGLE
УГОЛ ЛОРДОЗА

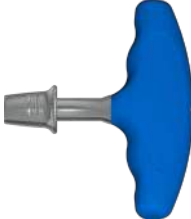
Wyukły Convex Выпуклый

Len	H	Ti
		8
20	9	3.8127.909S
	10	3.8127.910S
	11	3.8127.911S
	12	3.8127.912S
	13	3.8127.913S
	14	3.8127.914S
	15	3.8127.915S
	16	3.8127.916S
	17	3.8127.917S
25	18	3.8127.918S
	8	3.8128.908S
	9	3.8128.909S
	10	3.8128.910S
	11	3.8128.911S
	12	3.8128.912S
	13	3.8128.913S
	14	3.8128.914S
	15	3.8128.915S
30	16	3.8128.916S
	17	3.8128.917S
	18	3.8128.918S
	8	3.8129.908S
	9	3.8129.909S
	10	3.8129.910S
	11	3.8129.911S
	12	3.8129.912S
	13	3.8129.913S
14	3.8129.914S	
15	3.8129.915S	
16	3.8129.916S	
17	3.8129.917S	
18	3.8129.918S	



Len	Ti	B	Hmax	Hmin	Ti
25	0°	6	10	9	3.6981.010S
		7	11	10	3.6981.011S
			12	11	3.6981.012S
		8	13	12	3.6981.013S
			14	13	3.6981.014S
		10	15	14	3.6981.015S
			16	15	3.6981.016S
	7°	6	10	8	3.6981.710S
		7	11	9	3.6981.711S
			12	10	3.6981.712S
		8	13	11	3.6981.713S
			14	12	3.6981.714S
		10	15	13	3.6981.715S
			16	14	3.6981.716S
	14°	7	11	6	3.6981.141S
			12	7	3.6981.142S
8		13	8	3.6981.143S	
		14	9	3.6981.144S	
		15	10	3.6981.145S	
		16	11	3.6981.146S	

Instrumentarium do klatek międzykręgowych PLIF PEEK Cage (podstawowe) 15.0901.101 Instrument set for PLIF PEEK Intervertebral Cages (basic) Инструменты для межпозвоночных кейджи PLIF PEEK (основные)		Nr katalogowy Catalogue no. № по каталогу	Szt. Pcs. Шт.
	Rozszerzacz 9 Reamer 9 Расширитель 9	40.5805.009	1
	Rozszerzacz 10 Reamer 10 Расширитель 10	40.5805.010	1
	Rozszerzacz 11 Reamer 11 Расширитель 11	40.5805.011	1
	Rozszerzacz 12 Reamer 12 Расширитель 12	40.5805.012	1
	Rozszerzacz 13 Reamer 13 Расширитель 13	40.5805.013	1
	Rozszerzacz 14 Reamer 14 Расширитель 14	40.5805.014	1
	Rozszerzacz 15 Reamer 15 Расширитель 15	40.5805.015	1
	Rozszerzacz 16 Reamer 16 Расширитель 16	40.5805.016	1
	Rozszerzacz 17 Reamer 17 Расширитель 17	40.5805.017	1
	Rozszerzacz 18 Reamer 18 Расширитель 18	40.5805.018	1
	Rękojeść T z szybkozłączem 1/4 "Quick coupling handle T-type 1/4" "Рукоятка Т с быстроразъемным соединением 1/4"	40.6673.000	1
	Aplikator Applicator Аппликатор	40.5829.000	1
	Impaktor do klatek Impactor for cages Импактор для кейджей	40.5836.000	1
	Ubijak Compactor Пробойник	40.6190.000	1
	Statyw roboczy Working stand Подставка рабочая	40.5809.000	1
	Szczypce dystrykcyjne-szczęki Distraction forceps-jaws Дистракционные клещи-губки	40.5812.000	1
	Szczypce dystrykcyjne-szczęki Distraction forceps-jaws Дистракционные клещи-губки	40.5815.000	1
	Podważka 6 Elevator 6 Элеватор 6	40.4467.006	1
	Podważka 10 Elevator 10 Элеватор 10	40.4467.010	1

15.0901.101	Instrumentarium do klatek międzykręgowych PLIF PEEK Cage (podstawowe) Instrument set for PLIF PEEK Intervertebral Cages (basic) Инструменты для межпозвоночных кейджи PLIF PEEK (основные)	Nr katalogowy Catalogue no. № по каталогу	Szt. Pcs. Шт.
-------------	--	---	---------------------



Pokrywa kontenera 9x4
 Container lid 9x4
 Покрышка для контейнера 9x4

14.0901.103 1

Kontener 9x4H
 Container 9x4H
 Контейнер 9x4H

14.0901.101 1



Instrumentarium [15.0901.102] stanowi wyposażenie ponadstandardowe.













W celu dołączenia go do zamawianego instrumentarium podstawowego, proszę skontaktować się z lokalnym przedstawicielem lub Działem sprzedaży firmy ChM.

Instrument set [15.0901.102] is additional equipment.

In order to include the instruments to the ordered basic instrument set, please contact your local representative or ChM Sales Department.

Инструменты [15.0901.102] являются дополнительным оснащением.

Для заказа вышеуказанных дополнительных инструментов следует обратиться к представителю или отделу продаж компании ChM.

15.0901.102	Instrumentarium do klatek międzykręgowych PLIF PEEK Cage (rozszerzenie) Instrument set for PLIF PEEK Intervertebral Cages (extended) Инструменты для межпозвоночных кейджи PLIF PEEK (расширенные)	Nr katalogowy Catalogue no. № по каталогу	Szt. Pcs. Шт.
	Pilnik File Напильник	40.6196.000	1
	Skrobaczka kostna owalna Bone curette oval Распатор костный овальный	40.6192.000	1
	Skrobaczka kostna prostokątna Bone curette rectangular Распатор костный прямоугольный (rozszerzenie)	40.6193.000	1
	Skrobaczka kostna Bone curette Распатор костный прямоугольный	40.6198.000	1
	Skrobaczka kostna odgięta Bone curette curved Распатор костный изогнутый	40.6199.000	1
	Osteotom Osteotome Остеотом	40.6191.000	1
	Odgryzacz KERRISON, w górę, 130°, 230mm, 2mm KERRISON bone rongeur, upwards, 130°, 230mm, 2mm Кусачки костные Kerrison, вверх 130°, 230мм, 2мм	40.7086.002	1
	Odgryzacz KERRISON, w górę, 130°, 230mm, 4mm KERRISON bone rongeur, upwards, 130°, 230mm, 4mm Кусачки костные Kerrison, вверх 130°, 230мм, 4мм	40.7086.004	1
	Odgryzacz CUSHING, prosty, 230 mm, 2x10 mm CUSHING bone rongeur straight 230mm, 2x10mm Кусачки костные CUSHING прямые 230мм, 2x10мм	40.7027.042	1
	Odgryzacz SPURLING, prosty, 230 mm, 4x10 mm SPURLING bone rongeur straight 230mm 4x10mm Кусачки костные SPURLING прямые, 230мм 4x10мм	40.7033.044	1
	Odgryzacz CUSHING, w górę, 230mm, 2x10mm CUSHING bone rongeur upwards 230mm, 2x10mm Кусачки костные CUSHING вверх, 230мм, 2x10мм	40.7028.042	1
	Odgryzacz SPURLING, w górę, 230mm, 4x10mm SPURLING bone rongeur upwards 230mm, 4x10mm Кусачки костные SPURLING вверх, 230мм, 4x10мм	40.7034.044	1

15.0901.102	Instrumentarium do klatek międzykręgowych PLIF PEEK Cage (rozszerzenie)	Nr katalogowy	Szt.
	Instrument set for PLIF PEEK Intervertebral Cages (extended)	Catalogue no.	Pcs.
	Инструменты для межпозвоночных кейджи PLIF PEEK (расширенные)	№ по каталогу	Шт.



Kontener 9x4H
 Container 9x4H
 Контейнер 9x4H

14.0901.102 1

 Instrumentarium do klatek międzykręgowych-szczypce dystrykcyjne [15.0908.201] stanowi wyposażenie ponadstandardowe. W celu dołączenia go do zamawianego instrumentarium podstawowego, proszę skontaktować się z lokalnym przedstawicielem lub Działem sprzedaży firmy ChM. Instrument set for Intervertebral Cages - distraction forceps [15.0908.201] is additional equipment. In order to include the instrument to the ordered basic instrument set, please contact your local representative or ChM Sales Department. Инструменты для межпозвоночных кейджи - дистракционные клещи [15.0908.201] являются дополнительным оснащением. Для заказа вышеуказанных дополнительных инструментов следует обратиться к представителю или отделу продаж компании ChM.

15.0908.201	Instrumentarium do klatek międzykręgowych-szczypce dystrykcyjne (rozszerzenie)	Szt.	Nr katalogowy
	Instrument set for Intervertebral Cages - distraction forceps (extended)	Pcs.	Catalogue no.
	Инструменты для межпозвоночных кейджи - дистракционные клещи (расширенные)	Шт.	№ по каталогу

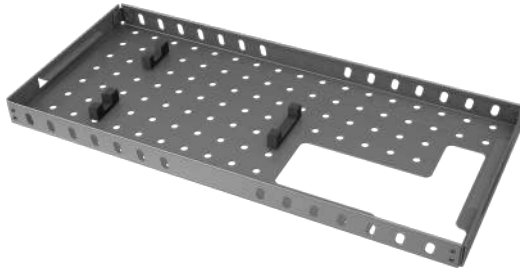

Paleta 9x4 1/2H
 Tray 9x4 1/2H
 Поддон 9x4 1/2H

1 14.0908.201

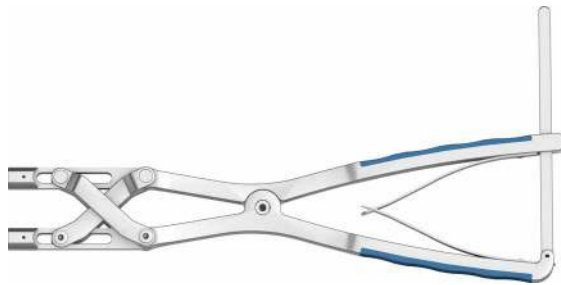

Szczypce dystrykcyjne równoległe
 Parallel distraction forceps
 Дистракционные параллельные клещи

1 40.8093.000

Narzędzia ponadstandardowe do implantacji klatek międzykręgowych PLIF rotacyjnych Non-standard instrument for use with 3D-Ti PLIF Rotary intervertebral cages

 W celu dołączenia poniższych narzędzi do instrumentarium do klatek PLIF, proszę skontaktować się z lokalnym przedstawicielem lub Działem sprzedaży firmy ChM. In order to include the instrument to the ordered PLIF instrument set, please contact your local representative or ChM Sales Department.



Aplikator
 Applicator
 Апликатор

1 40.6738.000

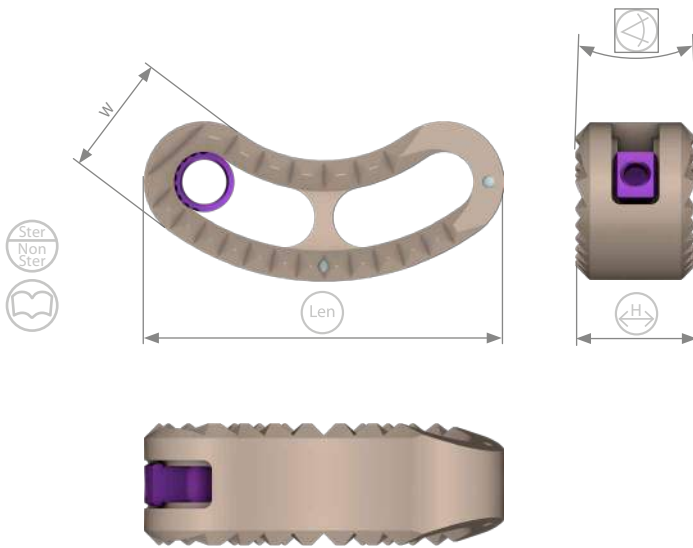

	Len	H	Peek				
0°	26	7	8.4550.007				
			8	8.4550.008			
			9	8.4550.009			
			10	8.4550.010			
			11	8.4550.011			
			12	8.4550.012			
			13	8.4550.013			
			14	8.4550.014			
			15	8.4550.015			
			16	8.4550.016			
			30°	26	7	8.4552.007	
						8	8.4552.008
						9	8.4552.009
						10	8.4552.010
						11	8.4552.011
						12	8.4552.012
13	8.4552.013						
14	8.4552.014						
15	8.4552.015						
16	8.4552.016						
5°	26	7				8.4551.007	
						8	8.4551.008
						9	8.4551.009
						10	8.4551.010
						11	8.4551.011
						12	8.4551.012
			13	8.4551.013			
			14	8.4551.014			
			15	8.4551.015			
			16	8.4551.016			
			30°	26	7	8.4553.007	
						8	8.4553.008
						9	8.4553.009
						10	8.4553.010
						11	8.4553.011
						12	8.4553.012
13	8.4553.013						
14	8.4553.014						
15	8.4553.015						
16	8.4553.016						



KĄT LORDOZY
 LORDOSIS ANGLE
 УГОЛ ЛОРДОЗА

PEEK-CHARSPINE

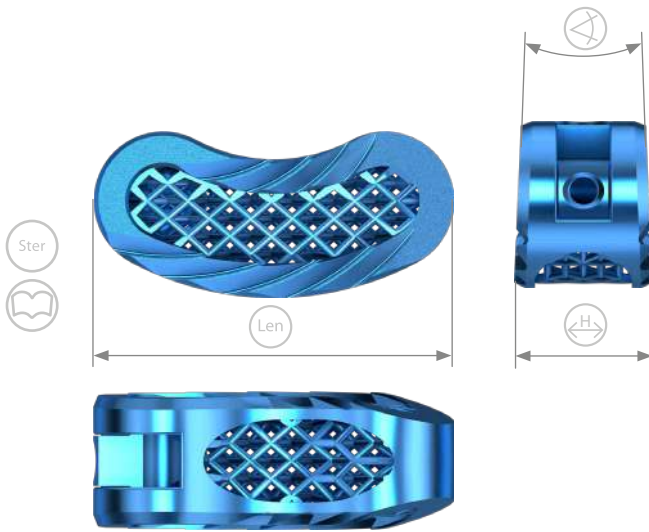

			7	3.6930.007S
			8	3.6930.008S
			9	3.6930.009S
			10	3.6930.010S
		26	11	3.6930.011S
			12	3.6930.012S
			13	3.6930.013S
			14	3.6930.014S
			15	3.6930.015S
			16	3.6930.016S
			7	3.6931.007S
			8	3.6931.008S
			9	3.6931.009S
			10	3.6931.010S
		0°	11	3.6931.011S
		30	12	3.6931.012S
			13	3.6931.013S
			14	3.6931.014S
			15	3.6931.015S
			16	3.6931.016S
			7	3.6932.007S
			8	3.6932.008S
			9	3.6932.009S
			10	3.6932.010S
		35	11	3.6932.011S
			12	3.6932.012S
			13	3.6932.013S
			14	3.6932.014S
			15	3.6932.015S
			16	3.6932.016S
			7	3.6930.507S
			8	3.6930.508S
			9	3.6930.509S
			10	3.6930.510S
		26	11	3.6930.511S
			12	3.6930.512S
			13	3.6930.513S
			14	3.6930.514S
			15	3.6930.515S
			16	3.6930.516S
			7	3.6931.507S
			8	3.6931.508S
			9	3.6931.509S
			10	3.6931.510S
		5°	11	3.6931.511S
		30	12	3.6931.512S
			13	3.6931.513S
			14	3.6931.514S
			15	3.6931.515S
			16	3.6931.516S
			7	3.6932.507S
			8	3.6932.508S
			9	3.6932.509S
			10	3.6932.510S
		35	11	3.6932.511S
			12	3.6932.512S
			13	3.6932.513S
			14	3.6932.514S
			15	3.6932.515S
			16	3.6932.516S

15.0904.101 Instrumentarium do klatek międzykręgowych TLIF PEEK (podstawowe)
 Instrument set for TLIF PEEK Intervertebral Cages (basic)
 Инструменты для межпозвоночных кейджи TLIF PEEK (основные)

Nr katalogowy Szt.
 Catalogue no. Pcs
 № по каталогу Шт.



Pokrywa kontenera 9x4H
 Container lid 9x4
 Покрышка для контейнера 9x4

14.0904.103 1

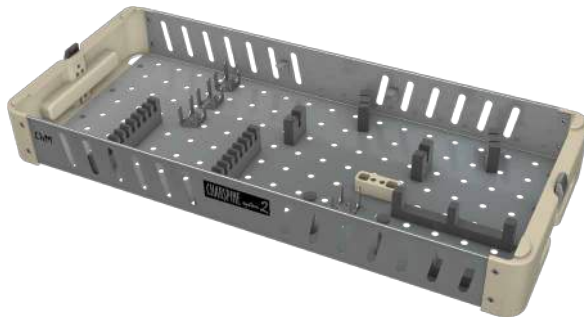

Kontener 9x4H
 Container 9x4H
 Контейнер 9x4H

14.0904.101 1

- Rozszerzacz 7 / Reamer 7 / Расширитель 7 40.5805.007 1
- Rozszerzacz 8 / Reamer 8 / Расширитель 8 40.5805.008 1
- Rozszerzacz 9 / Reamer 9 / Расширитель 9 40.5805.009 1
- Rozszerzacz 10 / Reamer 10 / Расширитель 10 40.5805.010 1
- Rozszerzacz 11 / Reamer 11 / Расширитель 11 40.5805.011 1
- Rozszerzacz 12 / Reamer 12 / Расширитель 12 40.5805.012 1
- Rozszerzacz 13 / Reamer 13 / Расширитель 13 40.5805.013 1
- Rozszerzacz 14 / Reamer 14 / Расширитель 14 40.5805.014 1
- Rozszerzacz 15 / Reamer 15 / Расширитель 15 40.5805.015 1
- Rozszerzacz 16 / Reamer 16 / Расширитель 16 40.5805.016 1

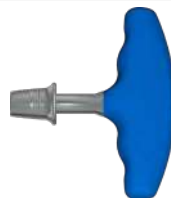

Rękojeść T z szybkozłączem 1/4"
 Quick coupling handle T-type 1/4"
 Рукоятка Т с быстроразъемным соединением 1/4"

40.6673.000 1

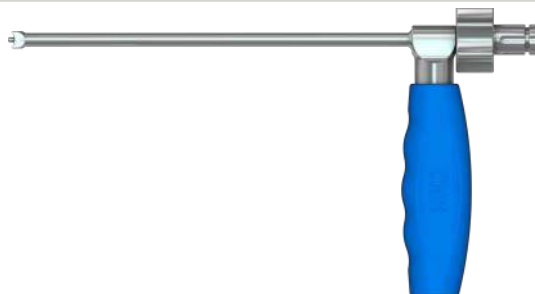

Aplikator
 Applicator
 Апликатор

40.6216.000 1



Ubijak
 Compactor
 Пробойник

40.6218.000 1



Impaktor
 Impactor
 Импактор

40.6219.000 1

15.0904.101 Instrumentarium do klatek międzykręgowych TLIF PEEK (podstawowe) Instrument set for TLIF PEEK Intervertebral Cages (basic) Инструменты для межпозвоночных кейджи TLIF PEEK (основные)		Nr katalogowy Catalogue no. № по каталогу	Szt. Pcs Шт.
	Manipulator Persuader Манипулятор	40.6217.000	1
	Statyw roboczy Working stand Подставка рабочая	40.6208.000	1
	Wbijak-wybijak Impactor-extractor Импактор-экстрактор	40.6209.000	1
	Podważka 6 / Elevator 6 / Элеватор 6	40.4467.006	1
	Podważka 10 / Elevator 10 / Элеватор 10	40.4467.010	1
	Szczypce dystrakcyjne-szczęki Distraction forceps-jaws Дистракционные клещи-губки	40.5812.000	1
	Statyw 4x2 Stand 4x2 Подставка 4x2	14.0904.201	1
	Przymiar duży 7 / Big trial 7 / Мера большая 7	40.6205.007	1
	Przymiar mały 7 / Small trial 7 / Мера малая 7	40.6206.007	1
	Przymiar duży 8 / Big trial 8 / Мера большая 8	40.6205.008	1
	Przymiar mały 8 / Small trial 8 / Мера малая 8	40.6206.008	1
	Przymiar duży 9 / Big trial 9 / Мера большая 9	40.6205.009	1
	Przymiar mały 9 / Small trial 9 / Мера малая 9	40.6206.009	1
	Przymiar duży 10 / Big trial 10 / Мера большая 10	40.6205.010	1
	Przymiar mały 10 / Small trial 10 / Мера малая 10	40.6206.010	1
	Przymiar duży 11 / Big trial 11 / Мера большая 11	40.6205.011	1
	Przymiar mały 11 / Small trial 11 / Мера малая 11	40.6206.011	1
	Przymiar duży 12 / Big trial 12 / Мера большая 12	40.6205.012	1
	Przymiar mały 12 / Small trial 12 / Мера малая 12	40.6206.012	1
	Przymiar duży 13 / Big trial 13 / Мера большая 13	40.6205.013	1
	Przymiar mały 13 / Small trial 13 / Мера малая 13	40.6206.013	1
	Przymiar duży 14 / Big trial 14 / Мера большая 14	40.6205.014	1
	Przymiar mały 14 / Small trial 14 / Мера малая 14	40.6206.014	1
	Przymiar duży 15 / Big trial 15 / Мера большая 15	40.6205.015	1
	Przymiar mały 15 / Small trial 15 / Мера малая 15	40.6206.015	1
	Przymiar duży 16 / Big trial 16 / Мера большая 16	40.6205.016	1
	Przymiar mały 16 / Small trial 16 / Мера малая 16	40.6206.016	1



Instrumentarium [15.0904.102] stanowi wyposażenie ponadstandardowe.
 W celu dołączenia go do zamawianego instrumentarium podstawowego, proszę skontaktować się z lokalnym przedstawicielem lub Działem sprzedaży firmy ChM.
 Instrument set [15.0904.102] is additional equipment.
 In order to include the instruments to the ordered basic instrument set, please contact your local representative or ChM Sales Department.
 Инструменты [15.0904.102] являются дополнительным оснащением.
 Для заказа вышеуказанных дополнительных инструментов следует обратиться к представителю или отделу продаж компании ChM.

15.0904.102	Instrumentarium do klatek międzykręgowych TLIF PEEK (rozszerzenie) Instrument set for TLIF PEEK Intervertebral Cages (extended) Инструменты для межпозвоночных кейджи TLIF PEEK (расширенные)	Nr katalogowy Catalogue no. № по каталогу	Szt. Pcs Шт.
	Kontener 9x4H Container 9x4H Контейнер 9x4H	14.0904.102	1
	Pilnik odgięty Curved file Напильник изогнутый	40.6197.000	1
	Skrobaczka kostna prostokątna prawa Bone curette rectangular right Распатор костный прямоугольный правый	40.6194.000	1
	Skrobaczka kostna prostokątna lewa Bone curette rectangular left Распатор костный прямоугольный левый	40.6195.000	1
	Osteotom Osteotome Остеотом	40.6191.000	1
	Skrobaczka kostna lewa Bone curette left Распатор костный левый	40.6201.000	1
	Skrobaczka kostna prawa Bone curette right Распатор костный правый	40.6200.000	1
	Odgryzacz SPURLING, prosty, 230mm, 4x10mm SPURLING bone rongeur straight 230mm 4x10mm Кусачки костные SPURLING прямые, 230мм 4x10мм	40.7033.044	1
	Odgryzacz SPURLING, w górę, 230mm, 4x10mm SPURLING bone rongeur upwards 230mm, 4x10mm Кусачки костные SPURLING вверх, 230мм, 4x10мм	40.7034.044	1
	Odgryzacz KERRISON, w górę, 130°, 230mm, 4 mm KERRISON bone rongeur, upwards, 130°, 230mm, 4mm Кусачки костные Kerrison, вверх 130°, 230мм, 4мм	40.7086.004	1



Instrumentarium [15.0908.201] stanowi wyposażenie ponadstandardowe.
 W celu dołączenia go do zamawianego instrumentarium podstawowego, proszę skontaktować się z lokalnym przedstawicielem lub Działem sprzedaży firmy ChM.
 Instrument set [15.0908.201] is additional equipment.
 In order to include the instruments to the ordered basic instrument set, please contact your local representative or ChM Sales Department.
 Инструменты [15.0908.201] являются дополнительным оснащением.
 Для заказа вышеуказанных дополнительных инструментов следует обратиться к представителю или отделу продаж компании ChM.

15.0908.201	Instrumentarium do klatek międzykręgowych-szczypce dystrakcyjne (rozszerzenie) Instrument set for Intervertebral Cages - distraction forceps (extended) Инструменты для межпозвоночных кейджи - клещи дистракционные (расширенные)	Nr katalogowy Catalogue no. № по каталогу	Szt. Pcs Шт.
-------------	--	---	--------------------

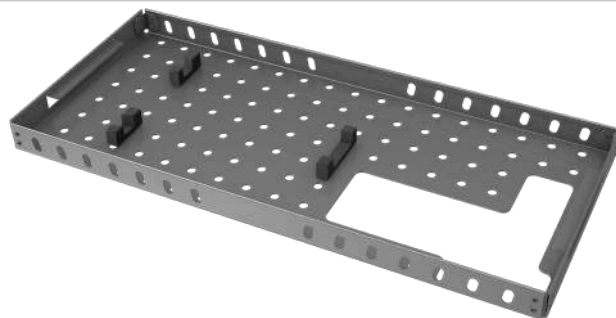

Paleta 9x4 1/2H
 Tray 9x4 1/2H
 Поддон 9x4 1/2H

14.0908.201

1

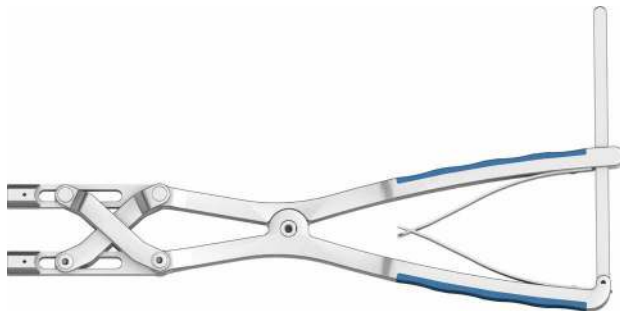

Szczypce dystrakcyjne
 Parallel distraction forceps
 Дистракционные параллельные клещи



40.8093.000

1

ALIF PEEK KLATKA MIĘDZYKRĘGOWA ŚREDNIA
ALIF PEEK INTERVERTEBRAL CAGE, MEDIUM
ALIF PEEK МЕЖПОЗВОНОЧНЫЙ КЕЙДЖ СРЕДНИЙ

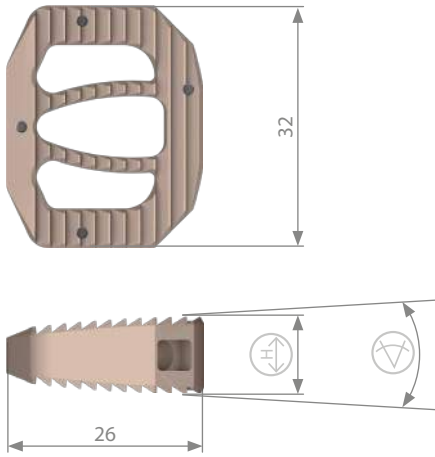
CHARSPINE system



			
8°			8.4560.010
			8.4560.011
			8.4560.013
			8.4560.015
			8.4560.017
			8.4560.019
12°			8.4561.010
			8.4561.011
			8.4561.013
			8.4561.015
			8.4561.017
			8.4561.019



 KĄT LORDOZY
LORDOSIS ANGLE
УГОЛ ЛОРДОЗА

PEEK-

ALIF PEEK KLATKA MIĘDZYKRĘGOWA DUŻA
ALIF PEEK INTERVERTEBRAL CAGE, LARGE
ALIF PEEK МЕЖПОЗВОНОЧНЫЙ КЕЙДЖ БОЛЬШОЙ

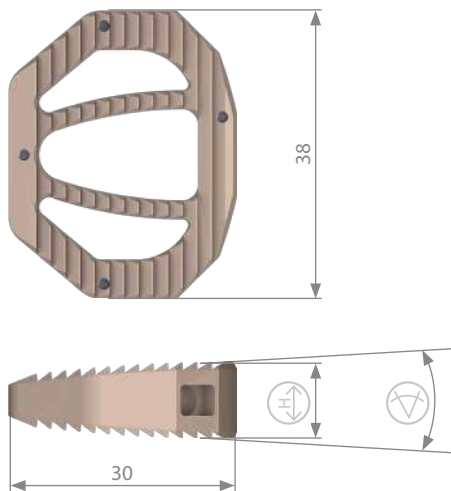





CHARSPINE system





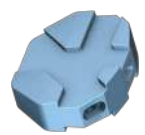
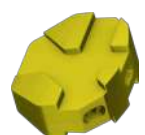

			
8°			8.4562.010
			8.4562.011
			8.4562.013
			8.4562.015
			8.4562.017
			8.4562.019
12°			8.4563.010
			8.4563.011
			8.4563.013
			8.4563.015
			8.4563.017
			8.4563.019

 KĄT LORDOZY
LORDOSIS ANGLE
УГОЛ ЛОРДОЗА

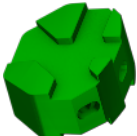
PEEK-

15.0906.101	Instrumentarium do klatek międzykręgowych ALIF PEEK Instrument set for ALIF PEEK Intervertebral Cages Инструменты для межпозвоночных кейджи ALIF PEEK	Nr katalogowy Catalogue no. № по каталогу	Szt. Pcs Шт.
	Manipulator Persuader Манипулятор	40.6182.000	2
	Szczypce dystrykcyjne Distraction forceps Дистракционные клещи	40.6233.000	1
	Pobijak Mallet Молоток щелевидный	40.6247.000	1
	Ubijak Compactor Пробойник	40.6190.000	1
	Raszpla średnia H-10 Bone rasp medium H-10 Рашпиль средний H-10	40.6183.010	1
	Raszpla średnia H-11 Bone rasp medium H-11 Рашпиль средний H-11	40.6183.011	1
	Raszpla średnia H-13 Bone rasp medium H-13 Рашпиль средний H-13	40.6183.013	1
	Raszpla średnia H-15 Bone rasp medium H-15 Рашпиль средний H-15	40.6183.015	1
	Raszpla średnia H-17 Bone rasp medium H-17 Рашпиль средний H-17	40.6183.017	1
	Raszpla średnia H-19 Bone rasp medium H-19 Рашпиль средний H-19	40.6183.019	1
		Przymiar średni H-10/8° Medium trial H-10/8° Мера средняя H-10/8°	40.6184.010
Przymiar średni H-10/12° Medium trial H-10/12° Мера средняя H-10/12°		40.6185.010	1
Przymiar duży H-10/8° Large trial H-10/8° Мера большая H-10/8°		40.6186.010	1
Przymiar duży H-10/12° Large trial H-10/12° Мера большая H-10/12°		40.6187.010	1
	Przymiar średni H-11/8° Medium trial H-11/8° Мера средняя H-11/8°	40.6184.011	1
	Przymiar średni H-11/12° Medium trial H-11/12° Мера средняя H-11/12°	40.6185.011	1
	Przymiar duży H-11/8° Large trial H-11/8° Мера большая H-11/8°	40.6186.011	1
	Przymiar duży H-11/12° Large trial H-11/12° Мера большая H-11/12°	40.6187.011	1
	Przymiar średni H-13/8° Medium trial H-13/8° Мера средняя H-13/8°	40.6184.013	1
	Przymiar średni H-13/12° Medium trial H-13/12° Мера средняя H-13/12°	40.6185.013	1
	Przymiar duży H-13/8° Large trial H-13/8° Мера большая H-13/8°	40.6186.013	1
	Przymiar duży H-13/12° Large trial H-13/12° Мера большая H-13/12°	40.6187.013	1

15.0906.101	Instrumentarium do klatek międzykręgowych ALIF PEEK Instrument set for ALIF PEEK Intervertebral Cages Инструменты для межпозвоночных кейджи ALIF PEEK	Nr katalogowy Catalogue no. № по каталогу	Szt. Pcs Шт.
	Przymiar średni H-15/8° Medium trial H-15/8° Мера средняя H-15/8°	40.6184.015	1
	Przymiar średni H-15/12° Medium trial H-15/12° Мера средняя H-15/12°	40.6185.015	1
	Przymiar duży H-15/8° Large trial H-15/8° Мера большая H-15/8°	40.6186.015	1
	Przymiar duży H-15/12° Large trial H-15/12° Мера большая H-15/12°	40.6187.015	1
	Przymiar średni H-17/8° Medium trial H-17/8° Мера средняя H-17/8°	40.6184.017	1
	Przymiar średni H-17/12° Medium trial H-17/12° Мера средняя H-17/12°	40.6185.017	1
	Przymiar duży H-17/8° Large trial H-17/8° Мера большая H-17/8°	40.6186.017	1
	Przymiar duży H-17/12° Large trial H-17/12° Мера большая H-17/12°	40.6187.017	1
	Przymiar średni H-19/8° Medium trial H-19/8° Мера средняя H-19/8°	40.6184.019	1
	Przymiar średni H-19/12° Medium trial H-19/12° Мера средняя H-19/12°	40.6185.019	1
	Przymiar duży H-19/8° Large trial H-19/8° Мера большая H-19/8°	40.6186.019	1
	Przymiar duży H-19/12° Large trial H-19/12° Мера большая H-19/12°	40.6187.019	1
		Statyw roboczy Working stand Подставка рабочая	40.6232.000
	Pokrywa kontenera 9x4 Container lid 9x4 Покрышка для контейнера 9x4	14.0906.102	1
	Kontener 4x9 Container 9x4H Контейнер 9x4H	14.0906.101	1

ALIF PEEK KLATKA MIĘDZYK. BLOK., ŚREDNIA
ALIF PEEK INTERVERT. LOCKING CAGE, MEDIUM
ALIF PEEK МЕЖПОЗВОН. БЛОК. КЕЙДЖ, СРЕДНИЙ

CHARSPINE system

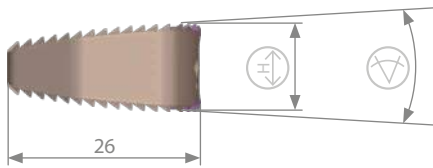
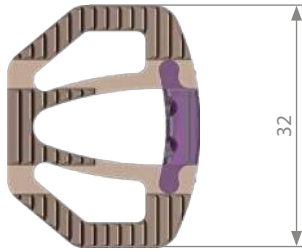

			Peek
8°		12.0	8.3992.082
		13.5	8.3992.083
		15.0	8.3992.085
		17.0	8.3992.087
		19.0	8.3992.089
12°		12.0	8.3992.122
		13.5	8.3992.123
		15.0	8.3992.125
		17.0	8.3992.127
		19.0	8.3992.129

KĄT LORDOZY
LORDOSIS ANGLE
УГОЛ ЛОРДОЗА

PEEK-

ALIF PEEK KLATKA MIĘDZYK. BLOK., DUŻA
ALIF PEEK INTERVERTEBR. LOCKING CAGE, LARGE
ALIF PEEK МЕЖПОЗВОН. БЛОК. КЕЙДЖ, БОЛЬШОЙ

CHARSPINE system

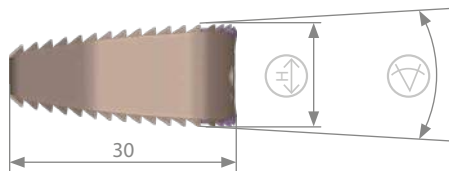
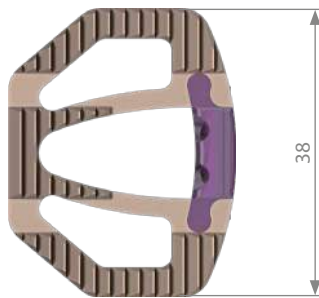











			Peek
8°		12.0	8.3993.082
		13.5	8.3993.083
		15.0	8.3993.085
		17.0	8.3993.087
		19.0	8.3993.089
12°		12.0	8.3993.122
		13.5	8.3993.123
		15.0	8.3993.125
		17.0	8.3993.127
		19.0	8.3993.129









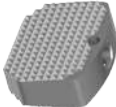

KĄT LORDOZY
LORDOSIS ANGLE
УГОЛ ЛОРДОЗА

PEEK-

WKRĘT BLOKUJACY 4,5
LOCKING SCREW 4.5
ЗАЖИМНОЙ ВИНТ 4,5

	Ti	Len				
	3.3920.015	10				
	3.3920.020	15	✓	✓	✓	4.5
	3.3920.025	25				
	3.3920.030	30				

15.0905.001	Instrumentarium do klitek międzykręgowych blokowanych ALIF PEEK Instrument set for ALIF PEEK Intervertebral Locking Cages Инструменты для межпозвоночных блокируемых кейджи ALIF PEEK	Nr katalogowy Catalogue no. № по каталогу	Szt. Pcs Шт.
	Manipulator Persuader Манипулятор	40.6224.000	1
	Trokar Trocar Троакап	40.6246.000	1
	Wkrętak T15 Screwdriver T15 Отвертка T15	40.5822.000	1
	Szcypce dystrykcyjne Distraction forceps Дистракционные клещи	40.5826.000	1
	Pinceta anatomiczna Standard, 30cm Dissecting forceps Standard 30cm Пинцет анатомический Стандарт, 30см	30.3317.000	1
	Pobijak Mallet Молоток щелевидный	40.6247.000	1
	Ubijak Compactor Пробойник	40.6190.000	1
	Rękojeść dynamometryczna T 2,8Nm T-type torque handle 2.8Nm Динамометрическая рукоятка T 2,8Nm	40.6666.000	1
	Pokrywa kontenera 9x4 Container lid 9x4 Покрышка для контейнера 9x4	14.0905.103	1
	Kontener 9x4H Container 9x4H Контейнер 9x4H	14.0905.101	1

15.0905.001	Instrumentarium do klatek międzykręgowych blokowanych ALIF PEEK Instrument set for ALIF PEEK Intervertebral Locking Cages Инструменты для межпозвоночных блокируемых кейджи ALIF PEEK	Nr katalogowy Catalogue no. № по каталогу	Szt. Pcs Шт.
	Chwytnik Holder Захват	40.5820.000	1
	Nakładka celująca H-12 / Aiming block H-12 / Шаблон накладка H-12	40.5821.002	1
	Nakładka celująca H-13,5 / Aiming block H-13.5 / Шаблон накладка H-13,5	40.5821.003	1
	Nakładka celująca H-15 / Aiming block H-15 / Шаблон накладка H-15	40.5821.005	1
	Nakładka celująca H-17 / Aiming block H-17 / Шаблон накладка H-17	40.5821.007	1
	Nakładka celująca H-19 / Aiming block H-19 / Шаблон накладка H-19	40.5821.009	1
	Raszpla średnia H-12 / Bone rasp medium H-12 / Рашпиль средний H-12	40.5816.002	1
	Raszpla średnia H-13,5 / Bone rasp medium H-13.5 / Рашпиль средний H-13,5	40.5816.003	1
	Raszpla średnia H-15 / Bone rasp medium H-15 / Рашпиль средний H-15	40.5816.005	1
	Raszpla średnia H-17 / Bone rasp medium H-17 / Рашпиль средний H-17	40.5816.007	1
	Raszpla średnia H-19 / Bone rasp medium H-19 / Рашпиль средний H-19	40.5816.009	1
	Przymiar średni H-12/8° / Medium trial H-12/8° / Мера средняя H-12/8°	40.5818.082	1
	Przymiar średni H-12/12° / Medium trial H-12/12° / Мера средняя H-12/12°	40.5818.122	1
	Przymiar duży H-12/8° / Large trial H-12/8° / Мера большая H-12/8°	40.5819.082	1
	Przymiar duży H-12/12° / Large trial H-12/12° / Мера большая H-12/12°	40.5819.122	1
	Przymiar średni H-13,5/8° / Medium trial H-13.5/8° / Мера средняя H-13,5/8°	40.5818.083	1
	Przymiar średni H-13,5/12° / Medium trial H-13.5/12° / Мера средняя H-13,5/12°	40.5818.123	1
	Przymiar duży 13,5/8 / Large gau trial ge 13.5/8 / Мера большая H-13,5/8°	40.5819.083	1
	Przymiar duży 13,5/12 / Large trial 13.5/12 / Мера большая H-13,5/12°	40.5819.123	1
	Przymiar średni H-15/8° / Medium trial H-15/8° / Мера средняя H-15/8°	40.5818.085	1
	Przymiar średni H-15/12° / Medium trial H-15/12° / Мера средняя H-15/12°	40.5818.125	1
	Przymiar duży H-15/8° / Large trial H-15/8° / Мера большая H-15/8°	40.5819.085	1
	Przymiar duży H-15/12° / Large trial H-15/12° / Мера большая H-15/12°	40.5819.125	1
	Przymiar średni H-17/8° / Medium trial H-17/8° / Мера средняя H-17/8°	40.5818.087	1
	Przymiar średni H-17/12° / Medium trial H-17/12° / Мера средняя H-17/12°	40.5818.127	1
	Przymiar duży H-17/8° / Large trial H-17/8° / Мера большая H-17/8°	40.5819.087	1
	Przymiar duży H-17/12° / Large trial H-17/12° / Мера большая H-17/12°	40.5819.127	1
	Przymiar średni H-19/8° / Medium trial H-19/8° / Мера средняя H-19/8°	40.5818.089	1
	Przymiar średni H-19/12° / Medium trial H-19/12° / Мера средняя H-19/12°	40.5818.129	1
	Przymiar duży H-19/8° / Large trial H-19/8° / Мера большая H-19/8°	40.5819.089	1
	Przymiar duży H-19/12° / Large gauge H-19/12° / Мера большая H-19/12°	40.5819.129	1
	Statyw roboczy Working stand Подставка рабочая	40.5825.000	1
	Kontener 9x4H Container 9x4H Контейнер 9x4H	14.0905.102	1



TRZON REGULOWANY M
EXPANDABLE BODY M
ИМПЛАНТАТ РЕГУЛИРУЕМЫЙ M

Size	Peek
25÷34	8.6050.025
31÷46	8.6050.031
42÷64	8.6050.042

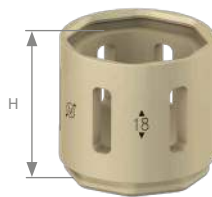

TULEJA PRZEDŁUŻAJĄCA M-XX
EXTENSION M-XX
ВТУЛКА УДЛИНЯЮЩАЯ M-XX

H	Peek
9	8.6051.009
18	8.6051.018

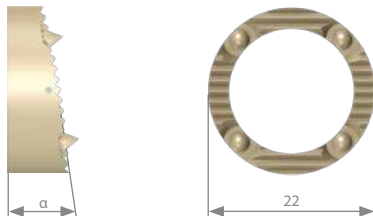

TALERZYK OPOROWY M Ø22
ENDPLATE M Ø22
КРЫШКА ЗУБЧАТАЯ M Ø22

α	Peek
0°	8.6052.000
3°	8.6052.003
5°	8.6052.005
9°	8.6052.009

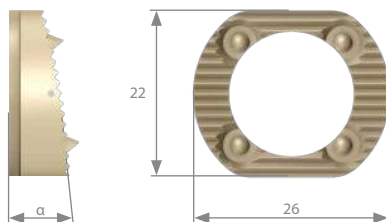

TALERZYK OPOROWY M 26X22
ENDPLATE M 26X22
КРЫШКА ЗУБЧАТАЯ M 26X22

α	Peek
0°	8.6053.000
3°	8.6053.003
5°	8.6053.005
9°	8.6053.009

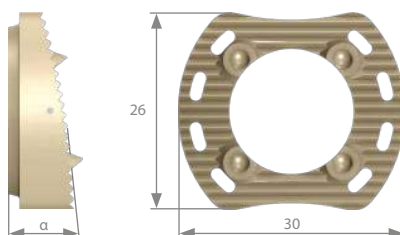

TALERZYK OPOROWY M 30X26
ENDPLATE M 30X26
КРЫШКА ЗУБЧАТАЯ M 30X26

α	Peek
0°	8.6054.000
3°	8.6054.003
5°	8.6054.005
9°	8.6054.009



TRZON REGULOWANY S (SMALL)
EXPANDABLE BODY S (SMALL)
ИМПЛАНТАТ РЕГУЛИРУЕМЫЙ S (SMALL)

Size	Peek
25÷34	8.6040.025
31÷46	8.6040.031
42÷64	8.6040.042



TULEJA PRZEDŁUŻAJĄCA S H-XX
EXTENSION S H-XX
ВТУЛКА УДЛИНЯЮЩАЯ S H-XX

H	Peek
9	8.6041.009
18	8.6041.018



TALERZYK OPOROWY M Ø18
ENDPLATE M Ø18
КРЫШКА ЗУБЧАТАЯ M Ø18

α	Peek
0°	8.6042.000
3°	8.6042.003
5°	8.6042.005
9°	8.6042.009

15.0914.101	Instrumentarium system implantów regulowanych VBR Instrument set for expandable VBR implants Инструменты-система имплантатов регулируемых VBR	Nr katalogowy Catalogue no. № по каталогу	Szt. Pcs Шт.
	Pokrywa kontenera 9x4H Container lid 9x4 Покрышка для контейнера 9x4	14.0914.102	1
	Kontener 9x4H Container 9x4H Контейнер 9x4H	14.0914.101	1
	Manipulator Persuader Манипулятор	40.6780.000	1
	Przymiar S 18 Trial S 18 Мера S 18	40.6781.018	1
	Przymiar M 22 Trial M 22 Мера M 22	40.6781.022	1
	Przymiar M 26x22 Trial M 26x22 Мера M 26x22	40.6781.026	1
	Przymiar M 30x26 Trial M 30x26 Мера M 30x26	40.6781.030	1
	Młotek 300g Hammer 300g Молоток 300г	40.6782.000	1
	Statyw roboczy Working stand Подставка рабочая	40.6783.000	1
	Podważka Elevator Элеватор	40.6784.000	1
	Pobijak Mallet Молоток щелевидный	40.6785.022	1
	Tuleja prowadząca M Guide sleeve M Втулка направляющая M	40.6786.022	1
	Pobijak Mallet Молоток щелевидный	40.6785.018	1
	Tuleja prowadząca S Guide sleeve S Втулка направляющая S	40.6787.000	1

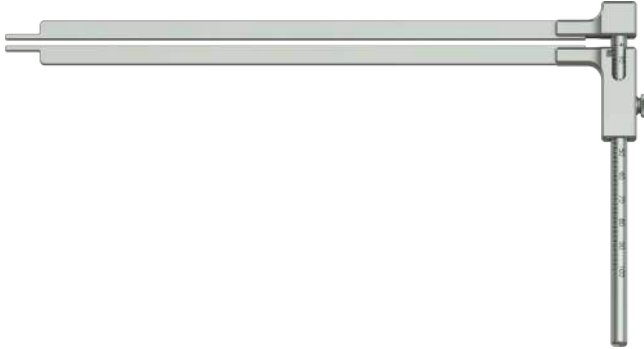
15.0914.101	Instrumentarium system implantów regulowanych VBR Instrument set for expandable VBR implants Инструменты-система имплантатов регулируемых VBR	Nr katalogowy Catalogue no. № по каталогу	Szt. Pcs Шт.
	Przymiar Trial Мера	40.8640.000	1

TRZON SIATKOWY
MESH BODY
ИМПЛАНТАТ СЕТЧАТЫЙ

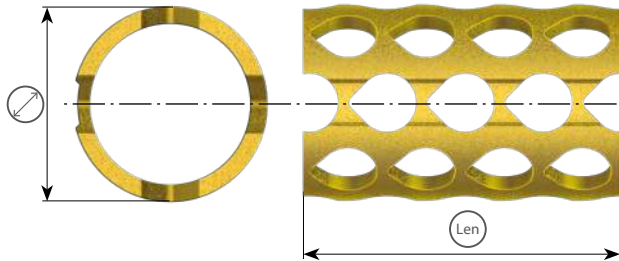

TALERZYK OPOROWY
ENDPLATE
КРЫШКА ЗУБЧАТАЯ

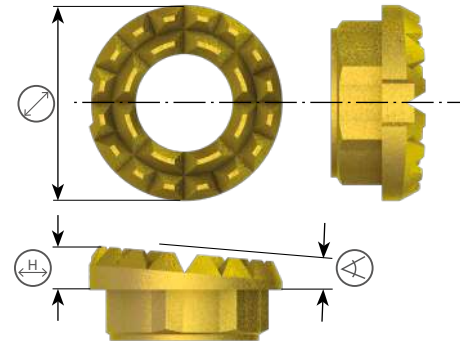

	Ø	Len	Ti	
odcinek szyjny cervical spine шейный отдел	10	7	3.8100.070	
		8	3.8100.080	
		12	3.8100.120	
		16	3.8100.160	
		20	3.8100.200	
		88	3.8100.880	
		12	7	3.8101.070
			8	3.8101.080
			12	3.8101.120
			16	3.8101.160
20	3.8101.200			
32	3.8101.320			
15	88	3.8101.880		
	odcinek szyjno- -pleciowy cervical and thoracic spine шейно-грудной отдел	7	3.8102.070	
		8	3.8102.080	
		12	3.8102.120	
		16	3.8102.160	
		20	3.8102.200	
32		3.8102.320		
20	88	3.8102.880		
	odcinek piersiowy thoracic spine грудной отдел	8	3.8103.080	
		16	3.8103.160	
		20	3.8103.200	
		24	3.8103.240	
		28	3.8103.280	
52		3.8103.520		
25	64	3.8103.640		
	88	3.8103.880		
	odcinek piersiowo-lędźwiowy thoracolumbar spine груднопоясничный отдел	8	3.8104.080	
		16	3.8104.160	
		20	3.8104.200	
		28	3.8104.280	
		32	3.8104.320	
		36	3.8104.360	
		40	3.8104.400	
		52	3.8104.520	
64		3.8104.640		
88		3.8104.880		
30	8	3.8105.080		
	16	3.8105.160		
	20	3.8105.200		
	28	3.8105.280		
	32	3.8105.320		
	36	3.8105.360		
	40	3.8105.400		
	52	3.8105.520		
	64	3.8105.640		
	88	3.8105.880		









	Ø	∠	H	Ti	
10	10	0	0.7	3.8106.000	
		2.5	1	3.8106.025	
		5	1	3.8106.050	
		12	0	0.7	3.8107.000
			2.5	1	3.8107.025
15	15	5	1.5	3.8107.050	
		0	0.7	3.8108.000	
		2.5	1	3.8108.025	
		5	1.5	3.8108.050	
		20	0	0.7	3.8109.000
2.5	1		3.8109.025		
25	25	5	2	3.8109.050	
		0	0.7	3.8110.000	
		2.5	1.5	3.8110.025	
		5	3	3.8110.050	
		30	30	0	0.7
2.5	1.5			3.8111.025	
5	3			3.8111.050	

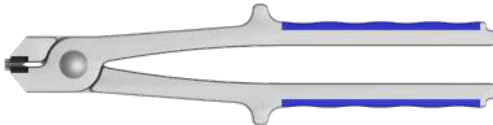

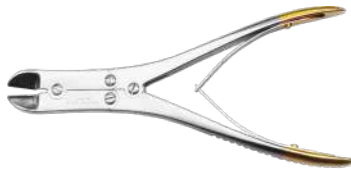
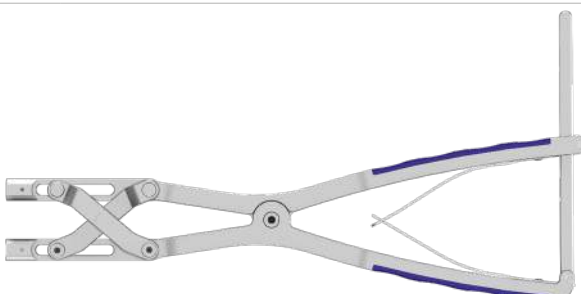



Identyfikacja talerzyka oporowego
Identification of the endplate
Идентификация тарельчатой опорки





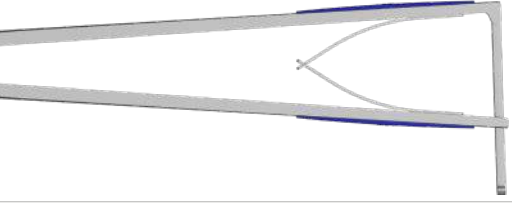

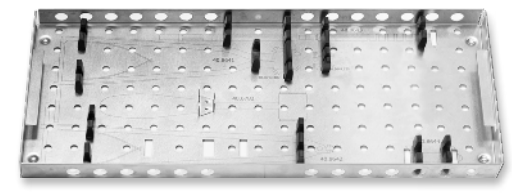
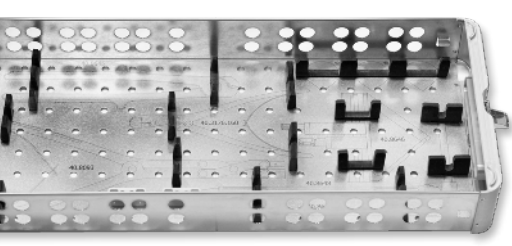

Oznaczenie talerzyków
Endplate marking
Маркировка тарельчатых опорок

Ø10		 po wewnętrznej stronie implantu on the implant inside на внутренней стороне имплантата
Ø12		
Ø15		
Ø20		 po zewnętrznej stronie implantu on the implant outside на внешней стороне имплантата
Ø25		
Ø30		









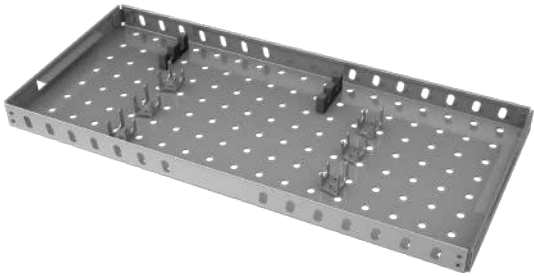

15.0916.001 Instrumentarium system implantów siatkowych VBR Instrument set for VBR mesh implants Инструменты-система имплантатов сетчатых VBR	Nr katalogowy Catalogue no. № по кат.	Szt. Pcs Шт.
	Kleszcze do cięcia Cutting pliers Щипцы для резания	40.8645.000 1
	Statyw roboczy Working stand Подставка рабочая	40.8646.100 1
	Kleszcze do cięcia drutu 16cm utwardz. Wire cutting pliers 16cm hardened Щипцы для резания проволоки упрочненные 16см	40.3176.160 1
	Szcypce dystrakcyjne równoległe Parallel distraction forceps Дистракционные параллельные клещи	40.8093.000 1
	Szcypce dystrakcyjne-szczęki Distraction forceps-jaws Дистракционные клещи-губки	40.8650.650 2
	Szcypce dystrakcyjne-szczęki Distraction forceps-jaws Дистракционные клещи-губки	40.8650.920 2
	Manipulator Persuader Манипулятор	40.8648.100 1
	Przymiar Trial Мера	40.8640.000 1
	Impaktor Impactor Импактор	40.8643.000 1

15.0916.001	Instrumentarium system implantów siatkowych VBR Instrument set for VBR mesh implants Инструменты-система имплантатов сетчатых VBR	Nr katalogowy Catalogue no. № по кат.	Szt. Pcs Шт.
	Applikator Applicator Апликатор	40.8652.000	1
	Młotek 300g Hammer 300g Молоток 300г	40.6782.000	1
	Applikator Applicator Апликатор	40.8642.000	1
	Pobijak Mallet Молоток щелевидный	40.8644.100	1
	Pokrywa kontenera 9x4H Container lid 9x4 Покрышка для контейнера 9x4	14.0916.102	1
	Paleta 9x4 1/2H Tray 9x4 1/2H Поддон 9x4 1/2H	14.0916.201	1
	Kontener 9x4H Container 9x4H Контейнер 9x4H	14.0916.101	1

15.0909.101	Bezpośrednia derotacja kręgów CHARSPINE2 VD CHARSPINE2 VD direct vertebral body derotation прямая деротация позвонков CHARSPINE2 VD	Nr katalogowy Catalogue no. № по кат.	Szt. Pcs Шт.
	Klamra derotacyjna Derotational clamp Скоба деротационная	40.6189.000	5
	Tuleja derotacyjna Derotational sleeve Втулка деротационная	40.6790.000	10
	Klucz S17 Wrench S17 Ключ S17	40.6793.000	1
	Rozszerzacz Reamer Расширитель	40.6794.000	1
	Paleta Tray Поддон	14.0909.201	1
	Kontener 9x4H Container lid 9x4 Контейнер 9x4H	14.0909.101	1
	Pokrywa 9x4 Container lid 9x4 Покрышка для контейнера 9x4	14.0909.102	1
Wyposażenie ponadstandardowe Additional equipment	Nazwa Name Название	Nr katalogowy Catalogue no. № по кат.	Szt. Pcs Шт.
	Pokrywa 1/1 595x275x15mm Container lid 1/1 595x275x15mm Покрышка алюм.перфорир.1/1 595x275x15мм Серая	12.0750.200	1
	Kontener z litym dnem 1/1 595x275x86mm Container with solid bottom 1/1 595x275x86mm Контейнер со сплошным дном 1/1 595x275x86мм	12.0750.100	1

15.0903.101	Instrumentarium 1/3 Instrument set 1/3 Инструменты 1/3	Nr katalogowy Catalogue no. № по кат.	Szt. Pcs Шт.
		Pokrywa kontenera 9x4 Container lid 9x4 Покрышка для контейнера 9x4	14.0903.103 1
		Kontener 9x4 H Container 9x4H Контейнер 9x4H	14.0903.101 1
		Osteotom Osteotome Остеотом	40.6191.000 1
		Skrobaczka kostna owalna prawa Bone curette oval right Распатор костный овальный правый	40.5838.000 1
		Skrobaczka kostna owalna lewa Bone curette oval left Распатор костный овальный левый	40.5839.000 1
		Skrobaczka kostna prostokątna prawa Bone curette rectangular right Распатор костный прямоугольный правый	40.6194.000 1
		Skrobaczka kostna prostokątna lewa Bone curette rectangular left Распатор костный прямоугольный левый	40.6195.000 1
		Skrobaczka kostna lewa Bone curette left Распатор костный левый	40.6201.000 1
		Skrobaczka kostna prawa Bone curette right Распатор костный правый	40.6200.000 1
		Podważka Elevator Элеватор	40.5837.000 1

15.0903.102	Instrumentarium 2/3 Instrument set 2/3 Инструменты 2/3	Nr katalogowy Catalogue no. № по кат.	Szt. Pcs Шт.
	Kontener 9x4 H Container 9x4H Контейнер 9x4H	14.0903.102	1
	Odgryzacz CUSHING, prosty, 230 mm, 2 x10 mm CUSHING bone rongeur straight 230mm, 2x10mm Кусачки костные CUSHING прямые 230мм, 2x10мм	40.7027.042	1
	Odgryzacz SPURLING, prosty, 230 mm, 4x10 mm SPURLING bone rongeur straight 230mm 4x10mm Кусачки костные SPURLING прямые, 230мм 4x10мм	40.7033.044	1
	Odgryzacz do neurochirurgii Ferris-Smith 6x10mm 23cm prosty FERRIS-SMITH neurosurgical bone rongeur 6x10mm 23cm straight Кусач.кост.д/невр.Ferris-Smith6x10mm 23cm прямые	40.7150.046	1
	Odgryzacz CUSHING, w górę, 230mm, 2x10mm CUSHING bone rongeur upwards 230mm, 2x10mm Кусачки костные CUSHING вверх, 230мм, 2x10мм	40.7028.042	1
	Odgryzacz SPURLING, w górę, 230mm, 4x10mm SPURLING bone rongeur upwards 230mm, 4x10mm Кусачки костные SPURLING вверх, 230мм, 4x10мм	40.7034.044	1
	Odgryzacz do neurochirurgii Ferris-Smith 6x10mm 23cm zagięty do góry FERRIS-SMITH neurosurgical bone rongeur 6x10mm 23cm curved up Кусач.кост.д/невр.Ferris-Smith6x10mm23cm изог.вв.	40.7151.046	1
	Odgryzacz Kerrison w górę 130° 2 mm KERRISON bone rongeur, upwards, 130°, 23cm, 2mm Кусачки костные Kerrison, вверх 130°, 230мм, 2мм	40.7086.002	1
	Odgryzacz Kerrison w górę 130° 4 mm KERRISON bone rongeur, upwards, 130°, 23cm, 4mm Кусачки костные Kerrison, вверх 130°, 230мм, 4мм	40.7086.004	1
	Odgryzacz Kerrison w górę 130° 6 mm KERRISON bone rongeur, upwards, 130°, 23cm, 6mm Кусачки костные Kerrison, вверх 130°, 230мм, 6мм	40.7086.006	1
	Odgryzacz kostny Sybert 8mm/360mm Sybert Bone rongeur 8/360mm Кусачки костные Sybert 8/360мм	40.3339.008	1

15.0903.201	Instrumentarium 3/3 Instrument set 3/3 Инструменты 3/3	Nr katalogowy Catalogue no. № по кат.	Szt. Pcs Шт.
	Paleta 9x4 1/2H Tray 9x4 1/2H Поддон 9x4 1/2H	14.0903.201	1
	Piłnik File Напильник	40.6196.000	1
	Piłnik odgięty Curved file Напильник изогнутый	40.6197.000	1
	Skrobaczka kostna Bone curette Распатор костный	40.6198.000	1
	Skrobaczka kostna odgięta Bone curette curved Распатор костный изогнутый	40.6199.000	1
	Skrobaczka kostna owalna Bone curette oval Распатор костный овальный	40.6192.000	1
	Skrobaczka kostna prostokątna Bone curette rectangular Распатор костный прямоугольный	40.6193.000	1
	Podważka 6mm Elevator 6 Элеватор 6	40.4467.006	1
	Podważka 10mm Elevator 10 Элеватор 10	40.4467.010	1
	Hak 4mm Cushing 28cm CUSHING retractor 4mm 28cm Крючок 4мм Cushing 28см	30.1010.000	1

Catalogue no. Nr katalogowy Каталожный Но.	Page Strona Страница	Catalogue no. Nr katalogowy Каталожный Но.	Page Strona Страница	Catalogue no. Nr katalogowy Каталожный Но.	Page Strona Страница	Catalogue no. Nr katalogowy Каталожный Но.	Page Strona Страница
3.3133.228	26	3.3970.833	34	3.5997.024	32	3.6107.045	36
3.3133.230	26	3.3970.853	34	3.5997.026	32	3.6107.055	36
3.3133.232	26	3.3970.855	54	3.5997.028	32	3.6109.006	37
3.3133.234	26	3.3970.863	34	3.5997.030	32	3.6109.008	37
3.3133.236	26	3.3970.865	54	3.5997.032	32	3.6109.010	37
3.3133.342	27	3.3970.866	54	3.5997.034	32	3.6109.012	37
3.3133.345	27	3.3970.933	34	3.5997.036	32	3.6109.014	37
3.3133.348	27	3.3970.953	34	3.5998.024	32	3.6109.016	37
3.3133.351	27	3.3970.955	54	3.5998.026	32	3.6110.006	37
3.3133.354	27	3.3970.963	34	3.5998.028	32	3.6110.008	37
3.3133.357	27	3.3970.965	54	3.5998.030	32	3.6110.010	37
3.3133.460	28	3.3970.966	54	3.5998.032	32	3.6110.012	37
3.3133.464	28	3.3972.033	53	3.5998.034	32	3.6110.014	37
3.3133.468	28	3.3972.037	53	3.5998.036	32	3.6110.016	37
3.3133.472	28	3.3972.040	53	3.5999.010	31	3.6111.000	31, 32, 34, 36
3.3133.476	28	3.3972.045	53	3.5999.012	31	3.6149.525	43
3.3133.480	28	3.3972.056	53	3.5999.014	31	3.6149.530	43
3.3133.614	25	3.3972.078	53	3.5999.016	31	3.6149.535	43
3.3133.616	25	3.3979.026	53	3.5999.018	31	3.6149.540	43
3.3133.618	25	3.3979.030	53	3.5999.020	31	3.6149.545	43
3.3133.620	25	3.3979.033	53	3.5999.022	31	3.6149.550	43
3.3133.622	25	3.3979.038	53	3.5999.024	31	3.6149.555	43
3.3133.624	25	3.3979.049	53	3.5999.026	31	3.6149.560	43
3.3133.626	25	3.3981.155	51	3.5999.028	31	3.6149.565	43
3.3133.628	25	3.3981.156	51	3.5999.030	31	3.6149.570	43
3.3133.635	25	3.3981.157	51	3.5999.032	31	3.6149.575	43
3.3136.023	24	3.3981.205	51	3.5999.034	31	3.6149.580	43
3.3136.025	24	3.3981.206	51	3.6100.010	31	3.6149.585	43
3.3136.027	24	3.3981.207	51	3.6100.012	31	3.6149.590	43
3.3136.029	24	3.3981.255	51	3.6100.014	31	3.6149.595	43
3.3201.012	24, 25, 26	3.3981.256	51	3.6100.016	31	3.6149.601	43
3.3201.014	24, 25, 26	3.3981.257	51	3.6100.018	31	3.6150.525	42
3.3201.016	24, 25, 26	3.3981.305	51	3.6100.020	31	3.6150.530	42
3.3201.018	24, 25, 26	3.3981.306	51	3.6100.022	31	3.6150.535	42
3.3202.012	24, 25, 26	3.3981.307	51	3.6100.024	31	3.6150.540	42
3.3202.014	24, 25, 26	3.3981.355	51	3.6100.026	31	3.6150.545	42
3.3202.016	24, 25, 26	3.3981.356	51	3.6100.028	31	3.6151.525	42
3.3202.018	24, 25, 26	3.3981.357	51	3.6100.030	31	3.6151.530	42
3.3246.040	49	3.3981.455	51	3.6100.032	31	3.6151.535	42
3.3246.050	49	3.3981.456	51	3.6100.034	31	3.6151.540	42
3.3246.060	49	3.3981.457	51	3.6100.036	31	3.6151.545	42
3.3246.070	49	3.3994.012	24, 25, 26	3.6100.038	31	3.6152.525	42
3.3246.080	49	3.3994.014	24, 25, 26	3.6100.040	31	3.6152.530	42
3.3246.090	49	3.3994.016	24, 25, 26	3.6101.010	31	3.6152.535	42
3.3246.100	49	3.3994.018	24, 25, 26	3.6101.012	31	3.6152.540	42
3.3246.120	49	3.3995.012	24, 25, 26	3.6101.014	31	3.6152.545	42
3.3246.140	49	3.3995.014	24, 25, 26	3.6101.016	31	3.6152.550	42
3.3246.160	49	3.3995.016	24, 25, 26	3.6101.018	31	3.6153.525	42
3.3246.180	49	3.3995.018	24, 25, 26	3.6101.020	31	3.6153.530	42
3.3246.200	49	3.3996.012	24, 25, 26	3.6101.022	31	3.6153.535	42
3.3246.220	49	3.3996.014	24, 25, 26	3.6101.024	31	3.6153.540	42
3.3246.260	49	3.3996.016	24, 25, 26	3.6101.026	31	3.6153.545	42
3.3246.300	49	3.3996.018	24, 25, 26	3.6101.028	31	3.6153.550	42
3.3246.360	49	3.3997.012	24, 25, 26	3.6101.030	31	3.6153.555	42
3.3246.400	49	3.3997.014	24, 25, 26	3.6101.032	31	3.6154.525	42
3.3246.460	49	3.3997.016	24, 25, 26	3.6101.034	31	3.6154.530	42
3.3246.500	49	3.3997.018	24, 25, 26	3.6101.036	31	3.6154.535	42
3.3248.040	49	3.3998.012	24, 25, 26	3.6101.038	31	3.6154.540	42
3.3248.050	49	3.3998.014	24, 25, 26	3.6101.040	31	3.6154.545	42
3.3248.060	49	3.3998.016	24, 25, 26	3.6102.001	34	3.6154.550	42
3.3248.070	49	3.3998.018	24, 25, 26	3.6102.002	34	3.6154.555	42
3.3248.080	49	3.3999.012	24, 25, 26	3.6103.012	33	3.6154.560	42
3.3248.090	49	3.3999.014	24, 25, 26	3.6103.020	33	3.6154.565	42
3.3248.100	49	3.3999.016	24, 25, 26	3.6104.034	33	3.6155.525	42
3.3248.120	49	3.3999.018	24, 25, 26	3.6104.042	33	3.6155.530	42
3.3248.140	49	3.5990.000	33	3.6104.055	33	3.6155.535	42
3.3248.160	49	3.5991.000	33	3.6105.040	35	3.6155.540	42
3.3248.180	49	3.5995.204	36	3.6105.060	35	3.6155.545	42
3.3248.200	49	3.5996.035	33	3.6105.090	35	3.6155.550	42
3.3920.015	104	3.5996.040	33	3.6105.150	35	3.6155.555	42
3.3920.020	104	3.5996.045	33	3.6105.240	35	3.6155.560	42
3.3920.025	104	3.5996.050	33	3.6106.400	35	3.6155.565	42
3.3920.030	104	3.5996.055	33	3.6107.035	36	3.6156.525	42

Catalogue no. Nr katalogowy Каталожный Но.	Page Strona Страница	Catalogue no. Nr katalogowy Каталожный Но.	Page Strona Страница	Catalogue no. Nr katalogowy Каталожный Но.	Page Strona Страница	Catalogue no. Nr katalogowy Каталожный Но.	Page Strona Страница
3.6156.530	42	3.6163.530	43	3.6169.590	43	3.6179.530	45
3.6156.535	42	3.6163.535	43	3.6169.595	43	3.6179.535	45
3.6156.540	42	3.6163.540	43	3.6169.601	43	3.6179.540	45
3.6156.545	42	3.6163.545	43	3.6170.525	44	3.6179.545	45
3.6156.550	42	3.6163.550	43	3.6170.530	44	3.6179.550	45
3.6156.555	42	3.6164.525	43	3.6170.535	44	3.6180.525	45
3.6156.560	42	3.6164.530	43	3.6170.540	44	3.6180.530	45
3.6156.565	42	3.6164.535	43	3.6170.545	44	3.6180.535	45
3.6156.570	42	3.6164.540	43	3.6170.550	44	3.6180.540	45
3.6156.575	42	3.6164.545	43	3.6171.525	44	3.6180.545	45
3.6156.580	42	3.6164.550	43	3.6171.530	44	3.6180.550	45
3.6156.585	42	3.6164.555	43	3.6171.535	44	3.6180.555	45
3.6156.590	42	3.6165.525	43	3.6171.540	44	3.6181.525	45
3.6157.525	42	3.6165.530	43	3.6171.545	44	3.6181.530	45
3.6157.530	42	3.6165.535	43	3.6171.550	44	3.6181.535	45
3.6157.535	42	3.6165.540	43	3.6172.525	44	3.6181.540	45
3.6157.540	42	3.6165.545	43	3.6172.530	44	3.6181.545	45
3.6157.545	42	3.6165.550	43	3.6172.535	44	3.6181.550	45
3.6157.550	42	3.6165.555	43	3.6172.540	44	3.6181.555	45
3.6157.555	42	3.6165.560	43	3.6172.545	44	3.6181.560	45
3.6157.560	42	3.6165.565	43	3.6172.550	44	3.6181.565	45
3.6157.565	42	3.6166.525	43	3.6172.555	44	3.6182.525	45
3.6157.570	42	3.6166.530	43	3.6173.525	44	3.6182.530	45
3.6157.575	42	3.6166.535	43	3.6173.530	44	3.6182.535	45
3.6157.580	42	3.6166.540	43	3.6173.535	44	3.6182.540	45
3.6157.585	42	3.6166.545	43	3.6173.540	44	3.6182.545	45
3.6157.590	42	3.6166.550	43	3.6173.545	44	3.6182.550	45
3.6157.595	42	3.6166.555	43	3.6173.550	44	3.6182.555	45
3.6157.601	42	3.6166.560	43	3.6173.555	44	3.6182.560	45
3.6158.525	42	3.6166.565	43	3.6174.525	44	3.6182.565	45
3.6158.530	42	3.6167.525	43	3.6174.530	44	3.6183.525	45
3.6158.535	42	3.6167.530	43	3.6174.535	44	3.6183.530	45
3.6158.540	42	3.6167.535	43	3.6174.540	44	3.6183.535	45
3.6158.545	42	3.6167.540	43	3.6174.545	44	3.6183.540	45
3.6158.550	42	3.6167.545	43	3.6174.550	44	3.6183.545	45
3.6158.555	42	3.6167.550	43	3.6174.555	44	3.6183.550	45
3.6158.560	42	3.6167.555	43	3.6174.560	44	3.6183.555	45
3.6158.565	42	3.6167.560	43	3.6174.565	44	3.6183.560	45
3.6158.570	42	3.6167.565	43	3.6175.525	44	3.6183.565	45
3.6158.575	42	3.6167.570	43	3.6175.530	44	3.6183.570	45
3.6158.580	42	3.6167.575	43	3.6175.535	44	3.6183.575	45
3.6158.585	42	3.6167.580	43	3.6175.540	44	3.6183.580	45
3.6158.590	42	3.6167.585	43	3.6175.545	44	3.6183.585	45
3.6158.595	42	3.6167.590	43	3.6175.550	44	3.6183.590	45
3.6158.601	42	3.6168.525	43	3.6175.555	44	3.6184.525	47
3.6159.525	42	3.6168.530	43	3.6175.560	44	3.6184.530	47
3.6159.530	42	3.6168.535	43	3.6175.565	44	3.6184.535	47
3.6159.535	42	3.6168.540	43	3.6176.525	44	3.6184.540	47
3.6159.540	42	3.6168.545	43	3.6176.530	44	3.6184.545	47
3.6159.545	42	3.6168.550	43	3.6176.535	44	3.6185.525	47
3.6159.550	42	3.6168.555	43	3.6176.540	44	3.6185.530	47
3.6159.555	42	3.6168.560	43	3.6176.545	44	3.6185.535	47
3.6159.560	42	3.6168.565	43	3.6176.550	44	3.6185.540	47
3.6159.565	42	3.6168.570	43	3.6176.555	44	3.6185.545	47
3.6159.570	42	3.6168.575	43	3.6176.560	44	3.6186.525	47
3.6159.575	42	3.6168.580	43	3.6176.565	44	3.6186.530	47
3.6159.580	42	3.6168.585	43	3.6176.570	44	3.6186.535	47
3.6159.585	42	3.6168.590	43	3.6176.575	44	3.6186.540	47
3.6159.590	42	3.6168.595	43	3.6176.580	44	3.6186.545	47
3.6159.595	42	3.6168.601	43	3.6176.585	44	3.6186.550	47
3.6159.601	42	3.6169.525	43	3.6176.590	44	3.6187.525	47
3.6160.000	42, 43, 44, 45, 46, 47, 48, 55	3.6169.530	43	3.6177.525	45	3.6187.530	47
3.6161.525	43	3.6169.535	43	3.6177.530	45	3.6187.535	47
3.6161.530	43	3.6169.540	43	3.6177.535	45	3.6187.540	47
3.6161.535	43	3.6169.545	43	3.6177.540	45	3.6187.545	47
3.6161.540	43	3.6169.550	43	3.6177.545	45	3.6187.550	47
3.6161.545	43	3.6169.555	43	3.6178.525	45	3.6187.555	47
3.6162.525	43	3.6169.560	43	3.6178.530	45	3.6188.525	47
3.6162.530	43	3.6169.565	43	3.6178.535	45	3.6188.530	47
3.6162.535	43	3.6169.570	43	3.6178.540	45	3.6188.535	47
3.6162.540	43	3.6169.575	43	3.6178.545	45	3.6188.540	47
3.6162.545	43	3.6169.580	43	3.6179.520	45	3.6188.545	47
3.6163.525	43	3.6169.585	43	3.6179.525	45	3.6188.550	47

Catalogue no. Nr katalogowy Каталожный Но.	Page Strona Страница	Catalogue no. Nr katalogowy Каталожный Но.	Page Strona Страница	Catalogue no. Nr katalogowy Каталожный Но.	Page Strona Страница	Catalogue no. Nr katalogowy Каталожный Но.	Page Strona Страница
3.6188.555	47	3.6197.555	48	3.6282.030	55	3.6514.585	46
3.6188.560	47	3.6197.560	48	3.6282.035	55	3.6514.590	46
3.6188.565	47	3.6197.565	48	3.6283.015	55	3.6515.525	46
3.6189.525	47	3.6197.570	48	3.6283.020	55	3.6515.530	46
3.6189.530	47	3.6197.575	48	3.6283.025	55	3.6515.535	46
3.6189.535	47	3.6197.580	48	3.6283.030	55	3.6515.540	46
3.6189.540	47	3.6197.585	48	3.6283.035	55	3.6515.545	46
3.6189.545	47	3.6197.590	48	3.6284.012	55	3.6515.550	46
3.6189.550	47	3.6266.001	57	3.6284.016	55	3.6515.555	46
3.6189.555	47	3.6266.002	57	3.6285.012	55	3.6515.560	46
3.6189.560	47	3.6266.003	57	3.6285.016	55	3.6515.565	46
3.6189.565	47	3.6267.001	57	3.6286.012	55	3.6515.570	46
3.6190.525	47	3.6267.002	57	3.6286.016	55	3.6515.575	46
3.6190.530	47	3.6267.003	57	3.6287.000	56	3.6515.580	46
3.6190.535	47	3.6268.001	57	3.6289.035	56	3.6515.585	46
3.6190.540	47	3.6268.002	57	3.6289.040	56	3.6515.590	46
3.6190.545	47	3.6268.003	57	3.6289.045	56	3.6530.525	44
3.6190.550	47	3.6269.001	57	3.6289.050	56	3.6530.530	44
3.6190.555	47	3.6269.002	57	3.6289.055	56	3.6530.535	44
3.6190.560	47	3.6269.003	57	3.6289.060	56	3.6530.540	44
3.6190.565	47	3.6269.101	57	3.6289.065	56	3.6530.545	44
3.6190.570	47	3.6269.102	57	3.6289.070	56	3.6530.550	44
3.6190.575	47	3.6269.103	57	3.6289.080	56	3.6530.555	44
3.6190.580	47	3.6270.001	57	3.6289.090	56	3.6530.560	44
3.6190.585	47	3.6270.002	57	3.6289.100	56	3.6530.565	44
3.6190.590	47	3.6270.003	57	3.6290.014	52	3.6530.570	44
3.6191.525	48	3.6271.002	57	3.6290.015	52	3.6530.575	44
3.6191.530	48	3.6272.002	57	3.6290.016	52	3.6530.580	44
3.6191.535	48	3.6273.002	57	3.6290.017	52	3.6530.585	44
3.6191.540	48	3.6273.102	57	3.6290.018	52	3.6530.590	44
3.6191.545	48	3.6274.002	57	3.6290.019	52	3.6530.595	44
3.6192.525	48	3.6274.102	57	3.6290.020	52	3.6530.600	44
3.6192.530	48	3.6275.001	58	3.6290.021	52	3.6531.525	44
3.6192.535	48	3.6275.002	58	3.6290.022	52	3.6531.530	44
3.6192.540	48	3.6275.003	58	3.6290.023	52	3.6531.535	44
3.6192.545	48	3.6276.001	58	3.6290.024	52	3.6531.540	44
3.6193.525	48	3.6276.002	58	3.6290.025	52	3.6531.545	44
3.6193.530	48	3.6276.003	58	3.6290.026	52	3.6531.550	44
3.6193.535	48	3.6276.101	58	3.6290.027	52	3.6531.555	44
3.6193.540	48	3.6276.102	58	3.6290.028	52	3.6531.560	44
3.6193.545	48	3.6276.103	58	3.6290.029	52	3.6531.565	44
3.6193.550	48	3.6280.035	50	3.6290.030	52	3.6531.570	44
3.6194.525	48	3.6280.040	50	3.6294.012	54	3.6531.575	44
3.6194.530	48	3.6280.045	50	3.6295.035	50	3.6531.580	44
3.6194.535	48	3.6280.050	50	3.6295.040	50	3.6531.585	44
3.6194.540	48	3.6280.055	50	3.6295.045	50	3.6531.590	44
3.6194.545	48	3.6280.060	50	3.6295.050	50	3.6531.595	44
3.6194.550	48	3.6280.065	50	3.6295.055	50	3.6531.600	44
3.6194.555	48	3.6280.070	50	3.6295.060	50	3.6532.525	44
3.6195.525	48	3.6280.075	50	3.6295.065	50	3.6532.530	44
3.6195.530	48	3.6280.080	50	3.6295.070	50	3.6532.535	44
3.6195.535	48	3.6280.085	50	3.6295.075	50	3.6532.540	44
3.6195.540	48	3.6280.090	50	3.6295.080	50	3.6532.545	44
3.6195.545	48	3.6280.095	50	3.6295.085	50	3.6532.550	44
3.6195.550	48	3.6280.100	50	3.6296.022	53	3.6532.555	44
3.6195.555	48	3.6280.110	50	3.6296.024	53	3.6532.560	44
3.6195.560	48	3.6280.120	50	3.6296.026	53	3.6532.565	44
3.6195.565	48	3.6280.130	50	3.6296.028	53	3.6532.570	44
3.6196.525	48	3.6280.140	50	3.6296.030	53	3.6532.575	44
3.6196.530	48	3.6280.150	50	3.6296.032	53	3.6532.580	44
3.6196.535	48	3.6280.160	50	3.6296.034	53	3.6532.585	44
3.6196.540	48	3.6280.170	50	3.6514.525	46	3.6532.590	44
3.6196.545	48	3.6280.180	50	3.6514.530	46	3.6532.595	44
3.6196.550	48	3.6280.190	50	3.6514.535	46	3.6532.600	44
3.6196.555	48	3.6280.200	50	3.6514.540	46	3.6533.525	45
3.6196.560	48	3.6281.015	55	3.6514.545	46	3.6533.530	45
3.6196.565	48	3.6281.020	55	3.6514.550	46	3.6533.535	45
3.6197.525	48	3.6281.025	55	3.6514.555	46	3.6533.540	45
3.6197.530	48	3.6281.030	55	3.6514.560	46	3.6533.545	45
3.6197.535	48	3.6281.035	55	3.6514.565	46	3.6533.550	45
3.6197.540	48	3.6282.015	55	3.6514.570	46	3.6533.555	45
3.6197.545	48	3.6282.020	55	3.6514.575	46	3.6533.560	45
3.6197.550	48	3.6282.025	55	3.6514.580	46	3.6533.565	45

Catalogue no. Nr katalogowy Каталожный Но.	Page Strona Страница	Catalogue no. Nr katalogowy Каталожный Но.	Page Strona Страница	Catalogue no. Nr katalogowy Каталожный Но.	Page Strona Страница	Catalogue no. Nr katalogowy Каталожный Но.	Page Strona Страница
3.6533.570	45	3.6570.040	76	3.6900.075	77	3.6925.415	88
3.6533.575	45	3.6570.045	76	3.6900.080	77	3.6925.416	88
3.6533.580	45	3.6570.050	76	3.6900.085	77	3.6925.417	88
3.6533.585	45	3.6570.055	76	3.6900.090	77	3.6925.418	88
3.6533.590	45	3.6570.060	76	3.6900.095	77	3.6925.708	88
3.6533.595	45	3.6570.065	76	3.6900.100	77	3.6925.709	88
3.6533.600	45	3.6571.030	76	3.6900.110	77	3.6925.710	88
3.6534.525	45	3.6571.035	76	3.6900.120	77	3.6925.711	88
3.6534.530	45	3.6571.040	76	3.6900.130	77	3.6925.712	88
3.6534.535	45	3.6571.045	76	3.6900.140	77	3.6925.713	88
3.6534.540	45	3.6571.050	76	3.6900.150	77	3.6925.714	88
3.6534.545	45	3.6571.055	76	3.6900.160	77	3.6925.715	88
3.6534.550	45	3.6571.060	76	3.6900.170	77	3.6925.716	88
3.6534.555	45	3.6571.065	76	3.6900.180	77	3.6925.717	88
3.6534.560	45	3.6571.070	76	3.6900.190	77	3.6925.718	88
3.6534.565	45	3.6571.075	76	3.6900.200	77	3.6925.908	88
3.6534.570	45	3.6571.080	76	3.6900.300	77	3.6925.909	88
3.6534.575	45	3.6571.085	76	3.6900.400	77	3.6925.910	88
3.6534.580	45	3.6571.090	76	3.6900.500	77	3.6925.911	88
3.6534.585	45	3.6572.030	76	3.6900.600	77	3.6925.912	88
3.6534.590	45	3.6572.035	76	3.6901.030	78	3.6925.913	88
3.6534.595	45	3.6572.040	76	3.6901.035	78	3.6925.914	88
3.6534.600	45	3.6572.045	76	3.6901.040	78	3.6925.915	88
3.6535.525	45	3.6572.050	76	3.6901.045	78	3.6925.916	88
3.6535.530	45	3.6572.055	76	3.6901.050	78	3.6925.917	88
3.6535.535	45	3.6572.060	76	3.6901.055	78	3.6925.918	88
3.6535.540	45	3.6572.065	76	3.6901.060	78	3.6926.008	88
3.6535.545	45	3.6572.070	76	3.6901.065	78	3.6926.009	88
3.6535.550	45	3.6572.075	76	3.6901.070	78	3.6926.010	88
3.6535.555	45	3.6572.080	76	3.6901.075	78	3.6926.011	88
3.6535.560	45	3.6572.085	76	3.6901.080	78	3.6926.012	88
3.6535.565	45	3.6572.090	76	3.6901.085	78	3.6926.013	88
3.6535.570	45	3.6572.095	76	3.6901.090	78	3.6926.014	88
3.6535.575	45	3.6572.100	76	3.6901.095	78	3.6926.015	88
3.6535.580	45	3.6573.030	76	3.6901.100	78	3.6926.016	88
3.6535.585	45	3.6573.035	76	3.6901.110	78	3.6926.017	88
3.6535.590	45	3.6573.040	76	3.6901.120	78	3.6926.018	88
3.6535.595	45	3.6573.045	76	3.6901.130	78	3.6926.140	88
3.6535.600	45	3.6573.050	76	3.6901.140	78	3.6926.141	88
3.6565.030	76	3.6573.055	76	3.6901.150	78	3.6926.142	88
3.6565.035	76	3.6573.060	76	3.6901.160	78	3.6926.143	88
3.6565.040	76	3.6573.065	76	3.6901.170	78	3.6926.144	88
3.6565.045	76	3.6573.070	76	3.6901.180	78	3.6926.145	88
3.6566.030	76	3.6573.075	76	3.6901.190	78	3.6926.146	88
3.6566.035	76	3.6573.080	76	3.6901.200	78	3.6926.147	88
3.6566.040	76	3.6573.085	76	3.6925.008	88	3.6926.148	88
3.6566.045	76	3.6573.090	76	3.6925.009	88	3.6926.408	88
3.6567.030	76	3.6573.095	76	3.6925.010	88	3.6926.409	88
3.6567.035	76	3.6573.100	76	3.6925.011	88	3.6926.410	88
3.6567.040	76	3.6574.030	76	3.6925.012	88	3.6926.411	88
3.6567.045	76	3.6574.035	76	3.6925.013	88	3.6926.412	88
3.6567.050	76	3.6574.040	76	3.6925.014	88	3.6926.413	88
3.6567.055	76	3.6574.045	76	3.6925.015	88	3.6926.414	88
3.6567.060	76	3.6574.050	76	3.6925.016	88	3.6926.415	88
3.6567.065	76	3.6574.055	76	3.6925.017	88	3.6926.416	88
3.6568.030	76	3.6574.060	76	3.6925.018	88	3.6926.417	88
3.6568.035	76	3.6574.065	76	3.6925.140	88	3.6926.418	88
3.6568.040	76	3.6574.070	76	3.6925.141	88	3.6926.708	88
3.6568.045	76	3.6574.075	76	3.6925.142	88	3.6926.709	88
3.6568.050	76	3.6574.080	76	3.6925.143	88	3.6926.710	88
3.6568.055	76	3.6574.085	76	3.6925.144	88	3.6926.711	88
3.6568.060	76	3.6574.090	76	3.6925.145	88	3.6926.712	88
3.6568.065	76	3.6574.095	76	3.6925.146	88	3.6926.713	88
3.6569.030	76	3.6574.100	76	3.6925.147	88	3.6926.714	88
3.6569.035	76	3.6900.030	77	3.6925.148	88	3.6926.715	88
3.6569.040	76	3.6900.035	77	3.6925.149	88	3.6926.716	88
3.6569.045	76	3.6900.040	77	3.6925.408	88	3.6926.717	88
3.6569.050	76	3.6900.045	77	3.6925.409	88	3.6926.718	88
3.6569.055	76	3.6900.050	77	3.6925.410	88	3.6926.908	88
3.6569.060	76	3.6900.055	77	3.6925.411	88	3.6926.909	88
3.6569.065	76	3.6900.060	77	3.6925.412	88	3.6926.910	88
3.6570.030	76	3.6900.065	77	3.6925.413	88	3.6926.911	88
3.6570.035	76	3.6900.070	77	3.6925.414	88	3.6926.912	88

Catalogue no. Nr katalogowy Каталожный Но.	Page Strona Страница	Catalogue no. Nr katalogowy Каталожный Но.	Page Strona Страница	Catalogue no. Nr katalogowy Каталожный Но.	Page Strona Страница	Catalogue no. Nr katalogowy Каталожный Но.	Page Strona Страница
3.6926.913	88	3.6932.513	96	3.6946.004	11	3.8102.080	111
3.6926.914	88	3.6932.514	96	3.6946.005	11	3.8102.120	111
3.6926.915	88	3.6932.515	96	3.6946.006	11	3.8102.160	111
3.6926.916	88	3.6932.516	96	3.6946.007	11	3.8102.200	111
3.6926.917	88	3.6935.004	11	3.6946.008	11	3.8102.320	111
3.6926.918	88	3.6935.005	11	3.6946.009	11	3.8102.880	111
3.6927.908	88	3.6935.006	11	3.6946.010	11	3.8103.080	111
3.6927.909	88	3.6935.007	11	3.6974.010	18	3.8103.160	111
3.6927.910	88	3.6935.008	11	3.6974.012	18	3.8103.200	111
3.6927.911	88	3.6935.009	11	3.6974.014	18	3.8103.240	111
3.6927.912	88	3.6935.010	11	3.6974.016	18	3.8103.280	111
3.6927.913	88	3.6936.004	11	3.6975.010	18	3.8103.520	111
3.6927.914	88	3.6936.005	11	3.6975.012	18	3.8103.640	111
3.6927.915	88	3.6936.006	11	3.6975.014	18	3.8103.880	111
3.6927.916	88	3.6936.007	11	3.6975.016	18	3.8104.080	111
3.6927.917	88	3.6936.008	11	3.6981.010	90	3.8104.160	111
3.6927.918	88	3.6936.009	11	3.6981.011	90	3.8104.200	111
3.6930.007	96	3.6936.010	11	3.6981.012	90	3.8104.280	111
3.6930.008	96	3.6937.004	11	3.6981.013	90	3.8104.320	111
3.6930.009	96	3.6937.005	11	3.6981.014	90	3.8104.360	111
3.6930.010	96	3.6937.006	11	3.6981.015	90	3.8104.400	111
3.6930.011	96	3.6937.007	11	3.6981.016	90	3.8104.520	111
3.6930.012	96	3.6937.008	11	3.6981.141	90	3.8104.640	111
3.6930.013	96	3.6937.009	11	3.6981.142	90	3.8104.880	111
3.6930.014	96	3.6937.010	11	3.6981.143	90	3.8105.080	111
3.6930.015	96	3.6938.004	11	3.6981.144	90	3.8105.160	111
3.6930.016	96	3.6938.005	11	3.6981.145	90	3.8105.200	111
3.6930.507	96	3.6938.006	11	3.6981.146	90	3.8105.280	111
3.6930.508	96	3.6938.007	11	3.6981.710	90	3.8105.320	111
3.6930.509	96	3.6938.008	11	3.6981.711	90	3.8105.360	111
3.6930.510	96	3.6938.009	11	3.6981.712	90	3.8105.400	111
3.6930.511	96	3.6938.010	11	3.6981.713	90	3.8105.520	111
3.6930.512	96	3.6939.004	11	3.6981.714	90	3.8105.640	111
3.6930.513	96	3.6939.005	11	3.6981.715	90	3.8105.880	111
3.6930.514	96	3.6939.007	11	3.6981.716	90	3.8106.000	111
3.6930.515	96	3.6939.009	11	3.6986.005	17	3.8106.250	111
3.6930.516	96	3.6940.004	11	3.6986.006	17	3.8106.500	111
3.6931.007	96	3.6940.005	11	3.6986.007	17	3.8107.000	111
3.6931.008	96	3.6940.006	11	3.6986.008	17	3.8107.250	111
3.6931.009	96	3.6940.007	11	3.6986.009	17	3.8107.500	111
3.6931.010	96	3.6940.008	11	3.6986.010	17	3.8108.000	111
3.6931.011	96	3.6940.009	11	3.6987.005	17	3.8108.250	111
3.6931.012	96	3.6940.010	11	3.6987.006	17	3.8108.500	111
3.6931.013	96	3.6941.004	11	3.6987.007	17	3.8109.000	111
3.6931.014	96	3.6941.005	11	3.6987.008	17	3.8109.250	111
3.6931.015	96	3.6941.006	11	3.6987.009	17	3.8109.500	111
3.6931.016	96	3.6941.007	11	3.6987.010	17	3.8110.000	111
3.6931.507	96	3.6941.008	11	3.6988.005	17	3.8110.250	111
3.6931.508	96	3.6941.009	11	3.6988.006	17	3.8110.500	111
3.6931.509	96	3.6941.010	11	3.6988.007	17	3.8111.000	111
3.6931.510	96	3.6942.004	11	3.6988.008	17	3.8111.250	111
3.6931.511	96	3.6942.005	11	3.6988.009	17	3.8111.500	111
3.6931.512	96	3.6942.007	11	3.6988.010	17	3.8127.0085	89
3.6931.513	96	3.6942.009	11	3.6989.005	17	3.8127.0095	89
3.6931.514	96	3.6942.010	11	3.6989.006	17	3.8127.0105	89
3.6931.515	96	3.6943.004	11	3.6989.007	17	3.8127.0115	89
3.6931.516	96	3.6943.005	11	3.6989.008	17	3.8127.0125	89
3.6932.007	96	3.6943.006	11	3.6989.009	17	3.8127.0135	89
3.6932.008	96	3.6943.007	11	3.6989.010	17	3.8127.0145	89
3.6932.009	96	3.6943.008	11	3.8100.070	111	3.8127.0155	89
3.6932.010	96	3.6943.009	11	3.8100.080	111	3.8127.0165	89
3.6932.011	96	3.6943.010	11	3.8100.120	111	3.8127.0175	89
3.6932.012	96	3.6944.004	11	3.8100.160	111	3.8127.0185	89
3.6932.013	96	3.6944.005	11	3.8100.200	111	3.8127.1405	89
3.6932.014	96	3.6944.006	11	3.8100.880	111	3.8127.1415	89
3.6932.015	96	3.6944.007	11	3.8101.070	111	3.8127.1425	89
3.6932.016	96	3.6944.008	11	3.8101.080	111	3.8127.1435	89
3.6932.507	96	3.6944.009	11	3.8101.120	111	3.8127.1445	89
3.6932.508	96	3.6944.010	11	3.8101.160	111	3.8127.1455	89
3.6932.509	96	3.6945.004	11	3.8101.200	111	3.8127.1465	89
3.6932.510	96	3.6945.005	11	3.8101.320	111	3.8127.1475	89
3.6932.511	96	3.6945.006	11	3.8101.880	111	3.8127.1485	89
3.6932.512	96	3.6945.010	11	3.8102.070	111	3.8127.1495	89

Catalogue no. Nr katalogowy Каталожный Но.	Page Strona Страница	Catalogue no. Nr katalogowy Каталожный Но.	Page Strona Страница	Catalogue no. Nr katalogowy Каталожный Но.	Page Strona Страница	Catalogue no. Nr katalogowy Каталожный Но.	Page Strona Страница
3.8127.408S	89	3.8128.717S	89	4.6900.030	77	8.3988.418	87
3.8127.409S	89	3.8128.718S	89	4.6900.035	77	8.3988.709	87
3.8127.410S	89	3.8128.908S	89	4.6900.040	77	8.3988.710	87
3.8127.411S	89	3.8128.909S	89	4.6900.045	77	8.3988.711	87
3.8127.412S	89	3.8128.910S	89	4.6900.050	77	8.3988.712	87
3.8127.413S	89	3.8128.911S	89	4.6900.055	77	8.3988.713	87
3.8127.414S	89	3.8128.912S	89	4.6900.060	77	8.3988.714	87
3.8127.415S	89	3.8128.913S	89	4.6900.065	77	8.3988.715	87
3.8127.416S	89	3.8128.914S	89	4.6900.070	77	8.3988.716	87
3.8127.417S	89	3.8128.915S	89	4.6900.075	77	8.3988.717	87
3.8127.418S	89	3.8128.916S	89	4.6900.080	77	8.3988.718	87
3.8127.708S	89	3.8128.917S	89	4.6900.085	77	8.3988.909	87
3.8127.709S	89	3.8128.918S	89	4.6900.090	77	8.3988.910	87
3.8127.710S	89	3.8129.908S	89	4.6900.095	77	8.3988.911	87
3.8127.711S	89	3.8129.909S	89	4.6900.100	77	8.3988.912	87
3.8127.712S	89	3.8129.910S	89	4.6900.110	77	8.3988.913	87
3.8127.713S	89	3.8129.911S	89	4.6900.120	77	8.3988.914	87
3.8127.714S	89	3.8129.912S	89	4.6900.130	77	8.3988.915	87
3.8127.715S	89	3.8129.913S	89	4.6900.140	77	8.3988.916	87
3.8127.716S	89	3.8129.914S	89	4.6900.150	77	8.3988.917	87
3.8127.717S	89	3.8129.915S	89	4.6900.160	77	8.3988.918	87
3.8127.718S	89	3.8129.916S	89	4.6900.170	77	8.3989.009	87
3.8127.908S	89	3.8129.917S	89	4.6900.180	77	8.3989.010	87
3.8127.909S	89	3.8129.918S	89	4.6900.190	77	8.3989.011	87
3.8127.910S	89	4.3249.040	49	4.6900.200	77	8.3989.012	87
3.8127.911S	89	4.3249.050	49	4.6900.300	77	8.3989.013	87
3.8127.912S	89	4.3249.060	49	4.6900.400	77	8.3989.014	87
3.8127.913S	89	4.3249.070	49	4.6900.500	77	8.3989.015	87
3.8127.914S	89	4.3249.080	49	4.6900.600	77	8.3989.016	87
3.8127.915S	89	4.3249.090	49	4.6901.030	78	8.3989.017	87
3.8127.916S	89	4.3249.100	49	4.6901.035	78	8.3989.018	87
3.8127.917S	89	4.3249.120	49	4.6901.040	78	8.3989.409	87
3.8127.918S	89	4.3249.140	49	4.6901.045	78	8.3989.410	87
3.8128.008S	89	4.3249.160	49	4.6901.050	78	8.3989.411	87
3.8128.009S	89	4.3249.180	49	4.6901.055	78	8.3989.412	87
3.8128.010S	89	4.3249.200	49	4.6901.060	78	8.3989.413	87
3.8128.011S	89	4.3980.040	49	4.6901.065	78	8.3989.414	87
3.8128.012S	89	4.3980.050	49	4.6901.070	78	8.3989.415	87
3.8128.013S	89	4.3980.060	49	4.6901.075	78	8.3989.416	87
3.8128.014S	89	4.3980.070	49	4.6901.080	78	8.3989.417	87
3.8128.015S	89	4.3980.080	49	4.6901.085	78	8.3989.418	87
3.8128.016S	89	4.3980.090	49	4.6901.090	78	8.3989.709	87
3.8128.017S	89	4.3980.100	49	4.6901.095	78	8.3989.710	87
3.8128.018S	89	4.3980.120	49	4.6901.100	78	8.3989.711	87
3.8128.140S	89	4.3980.140	49	4.6901.110	78	8.3989.712	87
3.8128.141S	89	4.3980.160	49	4.6901.120	78	8.3989.713	87
3.8128.142S	89	4.3980.180	49	4.6901.130	78	8.3989.714	87
3.8128.143S	89	4.3980.200	49	4.6901.140	78	8.3989.715	87
3.8128.144S	89	4.3980.220	49	4.6901.150	78	8.3989.716	87
3.8128.145S	89	4.3980.260	49	4.6901.160	78	8.3989.717	87
3.8128.146S	89	4.3980.300	49	4.6901.170	78	8.3989.718	87
3.8128.147S	89	4.3980.360	49	4.6901.180	78	8.3989.909	87
3.8128.148S	89	4.3980.400	49	4.6901.190	78	8.3989.910	87
3.8128.408S	89	4.3980.460	49	4.6901.200	78	8.3989.911	87
3.8128.409S	89	4.3980.500	49	8.3988.009	87	8.3989.912	87
3.8128.410S	89	4.3981.155	51	8.3988.010	87	8.3989.913	87
3.8128.411S	89	4.3981.156	51	8.3988.011	87	8.3989.914	87
3.8128.412S	89	4.3981.157	51	8.3988.012	87	8.3989.915	87
3.8128.413S	89	4.3981.205	51	8.3988.013	87	8.3989.916	87
3.8128.414S	89	4.3981.206	51	8.3988.014	87	8.3989.917	87
3.8128.415S	89	4.3981.207	51	8.3988.015	87	8.3989.918	87
3.8128.416S	89	4.3981.255	51	8.3988.016	87	8.3992.082	104
3.8128.417S	89	4.3981.256	51	8.3988.017	87	8.3992.083	104
3.8128.418S	89	4.3981.257	51	8.3988.018	87	8.3992.085	104
3.8128.708S	89	4.3981.305	51	8.3988.409	87	8.3992.087	104
3.8128.709S	89	4.3981.306	51	8.3988.410	87	8.3992.089	104
3.8128.710S	89	4.3981.307	51	8.3988.411	87	8.3992.122	104
3.8128.711S	89	4.3981.355	51	8.3988.412	87	8.3992.123	104
3.8128.712S	89	4.3981.356	51	8.3988.413	87	8.3992.125	104
3.8128.713S	89	4.3981.357	51	8.3988.414	87	8.3992.127	104
3.8128.714S	89	4.3981.455	51	8.3988.415	87	8.3992.129	104
3.8128.715S	89	4.3981.456	51	8.3988.416	87	8.3993.082	104
3.8128.716S	89	4.3981.457	51	8.3988.417	87	8.3993.083	104

Catalogue no. Nr katalogowy Каталожный Но.	Page Strona Страница	Catalogue no. Nr katalogowy Каталожный Но.	Page Strona Страница	Catalogue no. Nr katalogowy Каталожный Но.	Page Strona Страница	Catalogue no. Nr katalogowy Каталожный Но.	Page Strona Страница
8.3993.085	104	8.4557.008	10	8.4584.008	10	14.0902.202	14
8.3993.087	104	8.4557.009	10	8.4584.009	10	14.0902.203	14
8.3993.089	104	8.4557.010	10	8.4584.010	10	14.0902.204	15
8.3993.122	104	8.4558.004	10	8.4585.004	10	14.0903.101	115
8.3993.123	104	8.4558.005	10	8.4585.005	10	14.0903.102	116
8.3993.125	104	8.4558.006	10	8.4585.006	10	14.0903.103	115
8.3993.127	104	8.4558.007	10	8.4585.007	10	14.0903.201	117
8.3993.129	104	8.4558.008	10	8.4585.008	10	14.0904.101	97
8.4550.007	95	8.4558.009	10	8.4585.009	10	14.0904.102	99
8.4550.008	95	8.4558.010	10	8.4585.010	10	14.0904.103	97
8.4550.009	95	8.4559.004	10	8.6040.025	108	14.0904.201	98
8.4550.010	95	8.4559.005	10	8.6040.031	108	14.0905.101	105
8.4550.011	95	8.4559.006	10	8.6040.042	108	14.0905.102	106
8.4550.012	95	8.4559.007	10	8.6041.009	108	14.0905.103	105
8.4550.013	95	8.4559.008	10	8.6041.018	108	14.0906.101	103
8.4550.014	95	8.4559.009	10	8.6042.000	108	14.0906.102	103
8.4550.015	95	8.4559.010	10	8.6042.003	108	14.0907.111	74
8.4550.016	95	8.4560.010	101	8.6042.005	108	14.0907.112	74
8.4551.007	95	8.4560.011	101	8.6042.009	108	14.0907.113	74
8.4551.008	95	8.4560.013	101	8.6050.025	107	14.0907.114	74
8.4551.009	95	8.4560.015	101	8.6050.031	107	14.0907.115	74
8.4551.010	95	8.4560.017	101	8.6050.042	107	14.0907.203	75
8.4551.011	95	8.4560.019	101	8.6051.009	107	14.0907.204	75
8.4551.012	95	8.4561.010	101	8.6051.018	107	14.0907.211	74
8.4551.013	95	8.4561.011	101	8.6052.000	107	14.0907.212	74
8.4551.014	95	8.4561.013	101	8.6052.003	107	14.0908.201	94, 100
8.4551.015	95	8.4561.015	101	8.6052.005	107	14.0909.101	114
8.4551.016	95	8.4561.017	101	8.6052.009	107	14.0909.102	114
8.4552.007	95	8.4561.019	101	8.6053.000	107	14.0909.201	114
8.4552.008	95	8.4562.010	101	8.6053.003	107	14.0913.101	80, 86
8.4552.009	95	8.4562.011	101	8.6053.005	107	14.0913.102	81, 86
8.4552.010	95	8.4562.013	101	8.6053.009	107	14.0913.103	81, 86
8.4552.011	95	8.4562.015	101	8.6054.000	107	14.0913.104	83, 86
8.4552.012	95	8.4562.017	101	8.6054.003	107	14.0913.201	82, 86
8.4552.013	95	8.4562.019	101	8.6054.005	107	14.0913.202	84, 86
8.4552.014	95	8.4563.010	101	8.6054.009	107	14.0914.101	109
8.4552.015	95	8.4563.011	101	8.6970.505	16	14.0914.102	109
8.4552.016	95	8.4563.013	101	8.6970.506	16	14.0915.101	40
8.4553.007	95	8.4563.015	101	8.6970.507	16	14.0915.102	40
8.4553.008	95	8.4563.017	101	8.6970.508	16	14.0915.103	40
8.4553.009	95	8.4563.019	101	8.6970.509	16	14.0915.201	40
8.4553.010	95	8.4580.004	10	8.6970.510	16	14.0915.202	41
8.4553.011	95	8.4580.005	10	8.6971.505	16	14.0917.103	19
8.4553.012	95	8.4580.006	10	8.6971.506	16	14.0917.104	21
8.4553.013	95	8.4580.007	10	8.6971.507	16	14.0917.105	20
8.4553.014	95	8.4580.008	10	8.6971.508	16	14.0917.201	21
8.4553.015	95	8.4580.009	10	8.6971.509	16	14.0917.401	19
8.4553.016	95	8.4580.010	10	8.6971.510	16	14.0917.501	19
8.4554.004	10	8.4581.004	10	8.6972.005	16	14.0918.220	22
8.4554.005	10	8.4581.005	10	8.6972.006	16	15.0901.101	91
8.4554.006	10	8.4581.006	10	8.6972.007	16	15.0901.102	93
8.4554.007	10	8.4581.007	10	8.6972.008	16	15.0902.002	12
8.4554.008	10	8.4581.008	10	8.6972.009	16	15.0902.201	12, 13
8.4554.009	10	8.4581.009	10	8.6972.010	16	15.0902.202	12, 14
8.4554.010	10	8.4581.010	10	8.6973.005	16	15.0902.203	12, 14
8.4555.004	10	8.4582.004	10	8.6973.006	16	15.0902.204	12, 15
8.4555.005	10	8.4582.005	10	8.6973.007	16	15.0903.001	116, 117
8.4555.006	10	8.4582.006	10	8.6973.008	16	15.0903.101	115
8.4555.007	10	8.4582.007	10	8.6973.009	16	15.0903.102	116
8.4555.008	10	8.4582.008	10	8.6973.010	16	15.0903.201	117
8.4555.009	10	8.4582.009	10	12.0750.100	21, 75, 114	15.0904.101	97, 98
8.4555.010	10	8.4582.010	10	12.0750.200	21, 75, 114	15.0904.102	99
8.4556.004	10	8.4583.004	10	12.0751.100	19, 23	15.0905.001	105, 106
8.4556.005	10	8.4583.005	10	12.0751.200	19, 23	15.0906.101	102
8.4556.006	10	8.4583.006	10	14.0000.003	19	15.0907.002	70
8.4556.007	10	8.4583.007	10	14.0000.004	22	15.0907.011	65
8.4556.008	10	8.4583.008	10	14.0000.102	22	15.0907.012	68, 74, 75
8.4556.009	10	8.4583.009	10	14.0901.101	92	15.0907.111	65
8.4556.010	10	8.4583.010	10	14.0901.102	94	15.0907.112	66
8.4557.004	10	8.4584.004	10	14.0901.103	92	15.0907.114	68
8.4557.005	10	8.4584.005	10	14.0902.101	12	15.0907.203	70
8.4557.006	10	8.4584.006	10	14.0902.102	12	15.0907.204	70
8.4557.007	10	8.4584.007	10	14.0902.201	13	15.0907.211	67

Catalogue no. Nr katalogowy Каталожный Но.	Page Strona Страница	Catalogue no. Nr katalogowy Каталожный Но.	Page Strona Страница	Catalogue no. Nr katalogowy Каталожный Но.	Page Strona Страница	Catalogue no. Nr katalogowy Каталожный Но.	Page Strona Страница
15.0907.212	69	40.5816.002	106	40.6088.006	14	40.6190.000	91, 102, 105
15.0908.201	94, 100	40.5816.003	106	40.6088.007	14	40.6191.000	93, 99, 115
15.0909.101	114	40.5816.005	106	40.6088.008	14	40.6192.000	93, 117
15.0913.101	80, 86	40.5816.007	106	40.6088.009	14	40.6193.000	93, 117
15.0913.202	84	40.5816.009	106	40.6088.010	14	40.6194.000	99, 115
15.0914.101	109, 110	40.5818.082	106	40.6089.004	14	40.6195.000	99, 115
15.0915.101	38	40.5818.083	106	40.6089.005	14	40.6196.000	93, 117
15.0915.202	40	40.5818.085	106	40.6089.006	14	40.6197.000	99, 117
15.0916.001	112	40.5818.087	106	40.6089.007	14	40.6198.000	93, 117
15.0917.102	20, 21	40.5818.089	106	40.6089.008	14	40.6199.000	93, 117
15.0918.220	22	40.5818.122	106	40.6089.009	14	40.6200.000	99, 115
30.1010.000	117	40.5818.123	106	40.6089.010	14	40.6201.000	99, 115
30.3317.000	105	40.5818.125	106	40.6090.004	14	40.6205.007	98
40.3339.008	116	40.5818.127	106	40.6090.005	14	40.6205.008	98
40.4467.006	91, 98, 117	40.5818.129	106	40.6090.006	14	40.6205.009	98
40.4467.010	91, 98, 117	40.5819.082	106	40.6090.007	14	40.6205.010	98
40.4820.700	29	40.5819.083	106	40.6090.008	14	40.6205.011	98
40.4821.100	29	40.5819.085	106	40.6090.009	14	40.6205.012	98
40.4825.100	29	40.5819.087	106	40.6090.010	14	40.6205.013	98
40.4826.225	29	40.5819.089	106	40.6091.004	15	40.6205.014	98
40.4828.100	29	40.5819.122	106	40.6091.005	15	40.6205.015	98
40.4830.000	29	40.5819.123	106	40.6091.006	15	40.6205.016	98
40.4831.512	29	40.5819.125	106	40.6091.007	15	40.6206.007	98
40.4831.514	29	40.5819.127	106	40.6091.008	15	40.6206.008	98
40.4831.516	29	40.5819.129	106	40.6091.009	15	40.6206.009	98
40.4831.518	29	40.5820.000	106	40.6091.010	15	40.6206.010	98
40.4832.100	30	40.5821.002	106	40.6092.004	15	40.6206.011	98
40.4833.100	30	40.5821.003	106	40.6092.005	15, 21	40.6206.012	98
40.4834.100	30	40.5821.005	106	40.6092.006	15, 21	40.6206.013	98
40.4836.100	30	40.5821.007	106	40.6092.007	15, 21	40.6206.014	98
40.4838.600	30	40.5821.009	106	40.6092.008	15, 21	40.6206.015	98
40.4865.000	25, 26, 27, 28	40.5822.000	105	40.6092.009	15, 21	40.6206.016	98
40.5246.300	81	40.5825.000	106	40.6092.010	15, 21	40.6208.000	98
40.5286.100	29	40.5826.000	105	40.6093.004	15	40.6209.000	98
40.5770.000	38	40.5829.000	91	40.6093.005	15, 21	40.6216.000	97
40.5771.000	38	40.5836.000	91	40.6093.006	15, 21	40.6217.000	98
40.5772.000	38	40.5837.000	115	40.6093.007	15, 21	40.6218.000	97
40.5773.000	38	40.5838.000	115	40.6093.008	15, 21	40.6219.000	97
40.5774.000	38	40.5839.000	115	40.6093.009	15, 21	40.6224.000	105
40.5775.000	38	40.6075.000	13, 22	40.6093.010	15, 21	40.6232.000	103
40.5776.000	38	40.6076.014	13, 22	40.6099.000	39	40.6233.000	102
40.5777.024	39	40.6076.016	13, 22	40.6182.000	102	40.6246.000	105
40.5777.029	39	40.6077.000	13, 20	40.6183.010	102	40.6247.000	102, 105
40.5777.034	39	40.6078.000	13	40.6183.011	102	40.6654.001	20, 29, 40
40.5778.035	39	40.6079.000	13	40.6183.013	102	40.6655.233	40
40.5778.040	39	40.6079.100	20	40.6183.015	102	40.6666.000	105
40.5778.045	39	40.6080.000	13, 20	40.6183.017	102	40.6673.000	91, 97
40.5779.000	39	40.6081.004	14	40.6183.019	102	40.6738.000	94
40.5780.000	39	40.6081.005	14	40.6184.010	102	40.6780.000	109
40.5781.000	39	40.6081.006	14	40.6184.011	102	40.6781.122	109
40.5782.000	39	40.6081.007	14	40.6184.013	102	40.6781.126	109
40.5783.000	39	40.6081.008	14	40.6184.015	103	40.6781.130	109
40.5786.000	39	40.6081.009	14	40.6184.017	103	40.6782.000	109
40.5787.000	39	40.6081.010	14	40.6184.019	103	40.6783.000	109
40.5788.000	39	40.6082.004	14	40.6185.010	102	40.6784.000	109
40.5789.000	39	40.6082.005	14, 21	40.6185.011	102	40.6785.018	109
40.5790.000	39	40.6082.006	14, 21	40.6185.013	102	40.6785.022	109
40.5791.000	39	40.6082.007	14, 21	40.6185.015	103	40.6786.022	109
40.5805.007	97	40.6082.008	14, 21	40.6185.017	103	40.6787.000	109
40.5805.008	97	40.6082.009	14, 21	40.6185.019	103	40.6790.000	114
40.5805.009	91, 97	40.6082.010	14, 21	40.6186.010	102	40.6793.000	114
40.5805.010	91, 97	40.6083.004	14	40.6186.011	102	40.6794.000	114
40.5805.011	91, 97	40.6083.005	14, 21	40.6186.013	102	40.6795.000	62
40.5805.012	91, 97	40.6083.006	14, 21	40.6186.015	103	40.7027.042	93, 116
40.5805.013	91, 97	40.6083.007	14, 21	40.6186.017	103	40.7028.042	93, 116
40.5805.014	91, 97	40.6083.008	14, 21	40.6186.019	103	40.7033.044	93, 99, 116
40.5805.015	91, 97	40.6083.009	14, 21	40.6187.010	102	40.7034.044	93, 99, 116
40.5805.016	91, 97	40.6083.010	14, 21	40.6187.011	102	40.7086.002	93, 116
40.5805.017	91	40.6085.000	13	40.6187.013	102	40.7086.004	93, 99, 116
40.5805.018	91	40.6086.000	13, 22	40.6187.015	103	40.7086.006	116
40.5809.000	91	40.6087.000	13, 20	40.6187.017	103	40.7150.046	116
40.5812.000	91, 98	40.6088.004	14	40.6187.019	103	40.7151.046	116
40.5815.000	91	40.6088.005	14	40.6189.000	114	40.8060.000	74, 75

Catalogue no. Nr katalogowy Каталожный Но.	Page Strona Страница	Catalogue no. Nr katalogowy Каталожный Но.	Page Strona Страница
40.8061.000	75	40.8593.000	79
40.8064.000	59	40.8595.000	85
40.8065.000	60, 61	40.8601.000	85
40.8066.000	63	40.8640.000	110
40.8074.000	81	40.8780.100	20
40.8077.000	64	40.8781.100	20
40.8078.000	60, 62	40.8782.100	20
40.8079.000	63	40.8783.100	20
40.8080.000	60, 62	40.8784.000	20
40.8081.000	63	40.8785.105	20
40.8084.000	81	40.8785.106	20
40.8086.000	81	40.8785.107	20
40.8087.000	82	40.8785.108	20
40.8093.000	94, 100	40.8785.109	20
40.8111.000	80	40.8785.110	20
40.8119.000	60	40.8786.100	20
40.8346.000	37	40.8789.000	20
40.8348.000	40		
40.8350.000	40		
40.8351.000	40		
40.8352.029	40		
40.8352.034	40		
40.8353.029	41		
40.8353.034	41		
40.8354.040	41		
40.8354.045	41		
40.8355.040	41		
40.8355.045	41		
40.8356.000	41		
40.8357.000	41		
40.8358.000	41		
40.8359.000	41		
40.8555.000	85		
40.8557.000	85		
40.8557.600	85		
40.8558.000	85		
40.8558.600	85		
40.8559.600	85		
40.8560.000	83, 85		
40.8560.600	85		
40.8561.000	80		
40.8562.000	80		
40.8563.000	80		
40.8564.000	80		
40.8565.000	81		
40.8566.000	81		
40.8567.045	82		
40.8567.050	82		
40.8567.055	82		
40.8567.060	82		
40.8567.065	82		
40.8567.070	82		
40.8567.075	82		
40.8567.085	82		
40.8567.095	83		
40.8567.105	83		
40.8568.000	81		
40.8569.000	84		
40.8570.000	81		
40.8571.000	80		
40.8572.000	80		
40.8573.000	84		
40.8574.000	80		
40.8575.000	84		
40.8576.000	82		
40.8577.000	82		
40.8578.000	81		
40.8579.000	84		
40.8580.000	84		
40.8586.000	85		
40.8590.000	83		
40.8591.000	85		
40.8592.000	85		

ChM sp. z o.o.
Lewickie 3b
16-061 Juchnowiec Kościelny
Poland
tel. +48 85 86 86 100
fax +48 85 86 86 101
chm@chm.eu
www.chm.eu

