

II. IMPLANTS

ChARPEL reconstruction plate 3.5mm straight

Catalogue No.		
O	L [mm]	Steel
5	66	1.7052.005
6	78	1.7052.006
7	90	1.7052.007
8	102	1.7052.008
9	114	1.7052.009
10	126	1.7052.010
12	150	1.7052.012
14	174	1.7052.014
16	198	1.7052.016
18	222	1.7052.018
20	246	1.7052.020
22	270	1.7052.022

O - threaded holes number in the plate

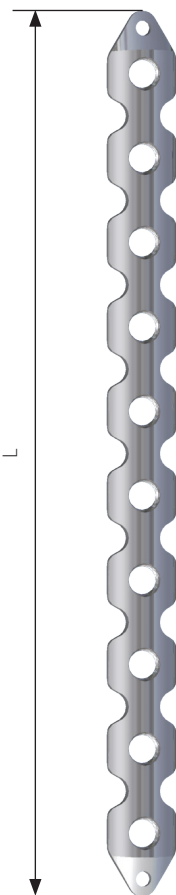

ChARPEL reconstruction plate 3.5 straight

Catalogue No.

O	L [mm]	Steel
5	66	1.3118.005
6	78	1.3118.006
7	90	1.3118.007
8	102	1.3118.008
9	114	1.3118.009
10	126	1.3118.010
12	150	1.3118.012
14	174	1.3118.014
16	198	1.3118.016
18	222	1.3118.018
20	246	1.3118.020
22	270	1.3118.022

O - holes number in the plate

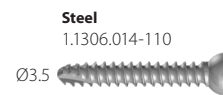
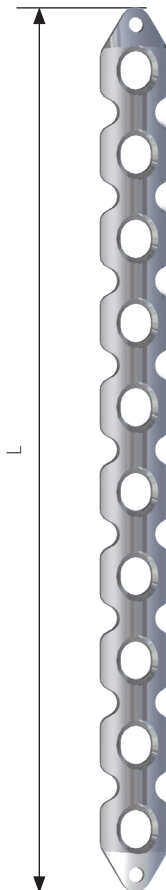

ChARPEL reconstruction plate 4.5 straight

Catalogue No.		
O	L [mm]	Steel
3	52	1.3119.003
4	68	1.3119.004
5	84	1.3119.005
6	100	1.3119.006
7	116	1.3119.007
8	132	1.3119.008
9	148	1.3119.009
10	164	1.3119.010
11	180	1.3119.011
12	196	1.3119.012
13	212	1.3119.013
14	228	1.3119.014
15	244	1.3119.015
16	260	1.3119.016

O - holes number in the plate

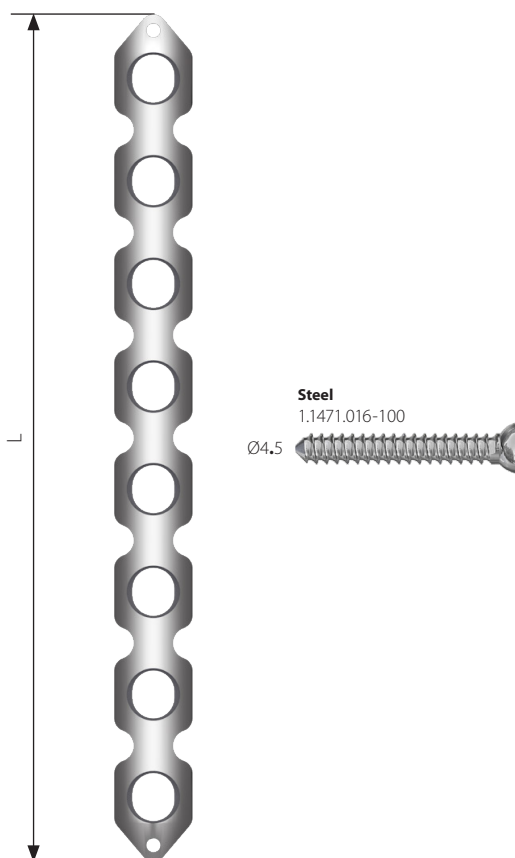

ChARPEL reconstruction plate R108 4.5mm

Catalogue No.		
O	L [mm]	Steel
4	72	1.3037.004
6	102	1.3037.006
8	129	1.3037.008
10	154	1.3037.010
12	175	1.3037.012
14	193	1.3037.014
16	208	1.3037.016

O - holes number in the plate

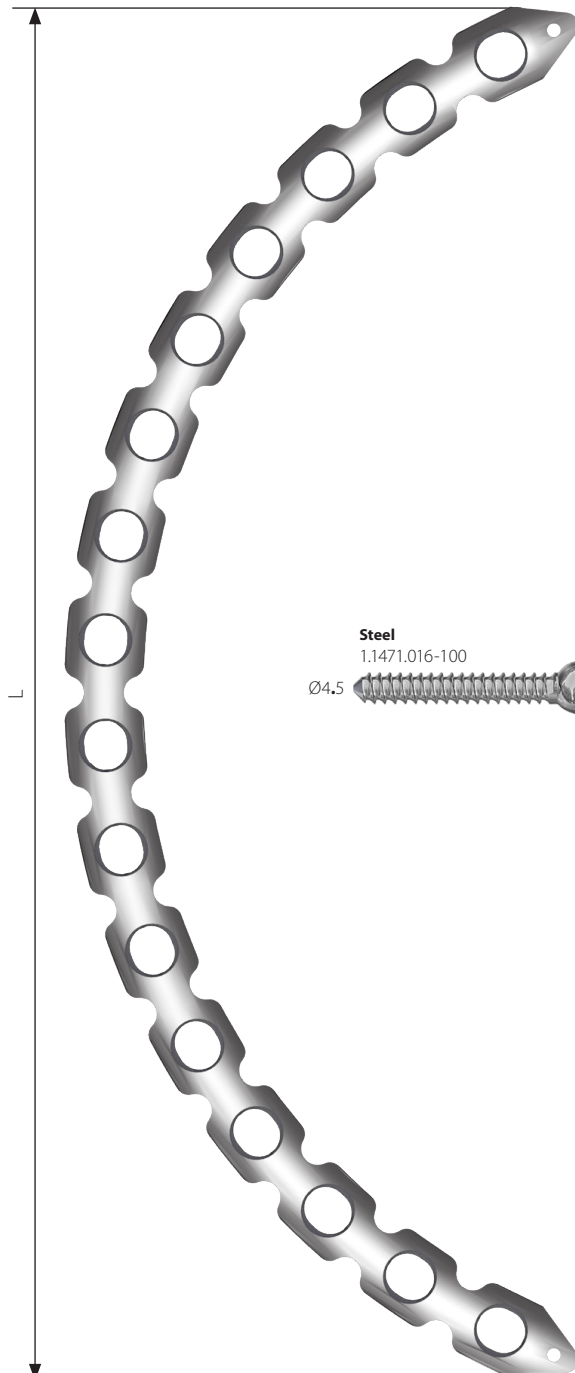

ChARPEL reconstruction plate 3.5mm R100

Catalogue No.

O	L [mm]	Steel
4	59	1.7053.004
6	82	1.7053.006
8	104	1.7053.008
10	124	1.7053.010
12	143	1.7053.012
14	159	1.7053.014
16	173	1.7053.016
18	185	1.7053.018

O - threaded holes number in the plate

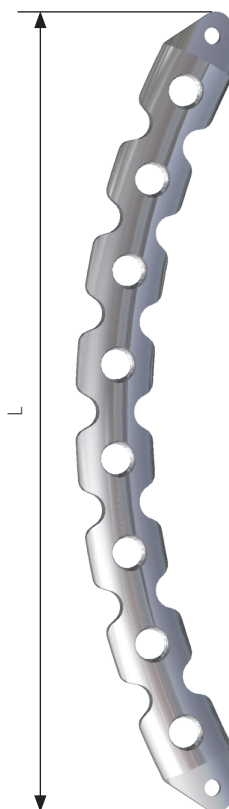

ChARPEL reconstruction plate R100 3.5mm

Catalogue No.

O	L [mm]	Steel
4	59	1.3117.004
6	82	1.3117.006
8	104	1.3117.008
10	124	1.3117.010
12	143	1.3117.012
14	159	1.3117.014
16	173	1.3117.016
18	185	1.3117.018

O - holes number in the plate

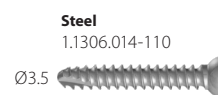
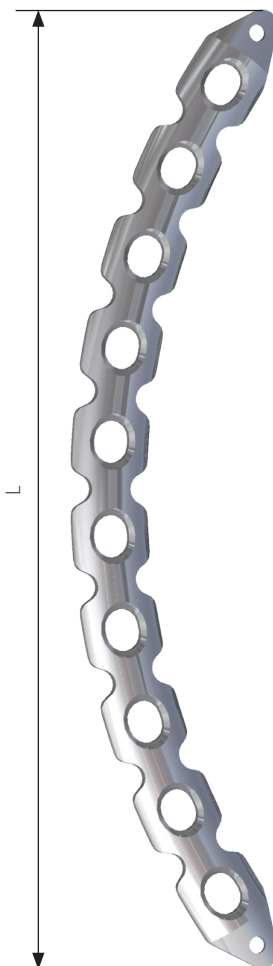

ChARPEL reconstruction J plate

Left		
Catalogue No.		
O	L [mm]	Steel
10	123	1.7013.010
12	143	1.7013.012
14	163	1.7013.014
16	181	1.7013.016

Right		
Catalogue No.		
O	L [mm]	Steel
10	123	1.7012.010
12	143	1.7012.012
14	163	1.7012.014
16	181	1.7012.016

O - threaded holes number in the plate

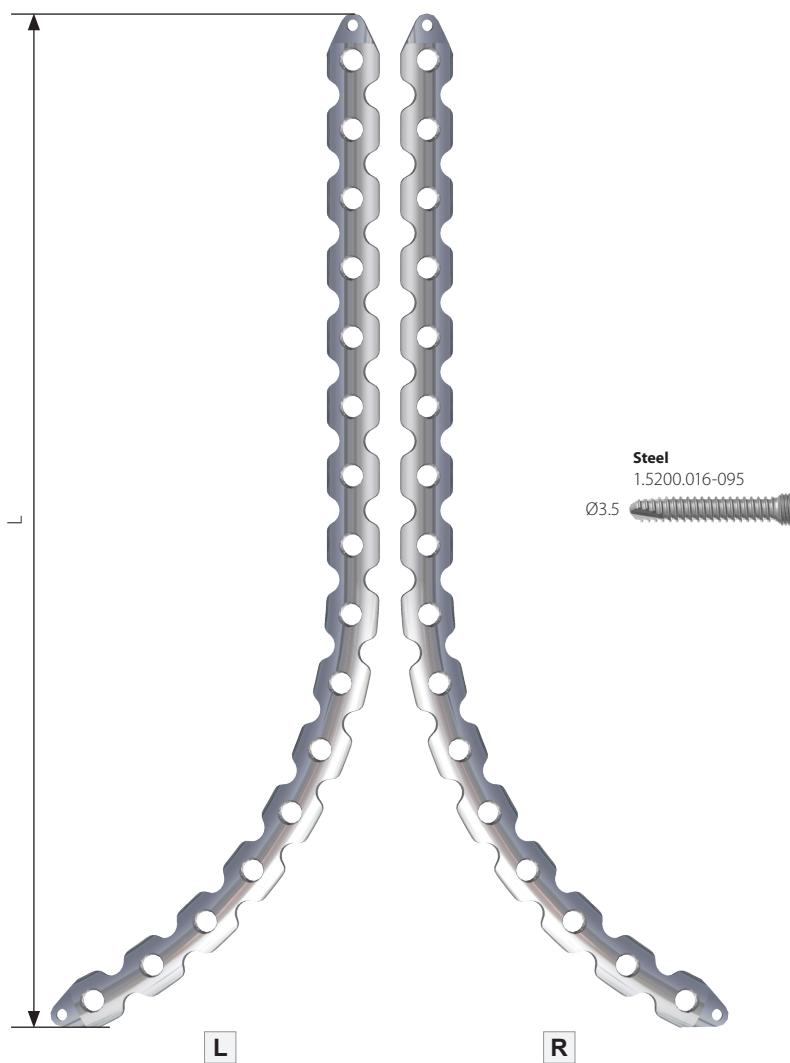

ChARPEL reconstruction J plate

Left		
Catalogue No.		
O	L [mm]	Steel
10	123	1.3036.010
12	143	1.3036.012
14	163	1.3036.014
16	181	1.3036.016

Right		
Catalogue No.		
O	L [mm]	Steel
10	123	1.3035.010
12	143	1.3035.012
14	163	1.3035.014
16	181	1.3035.016

O - holes number in the plate

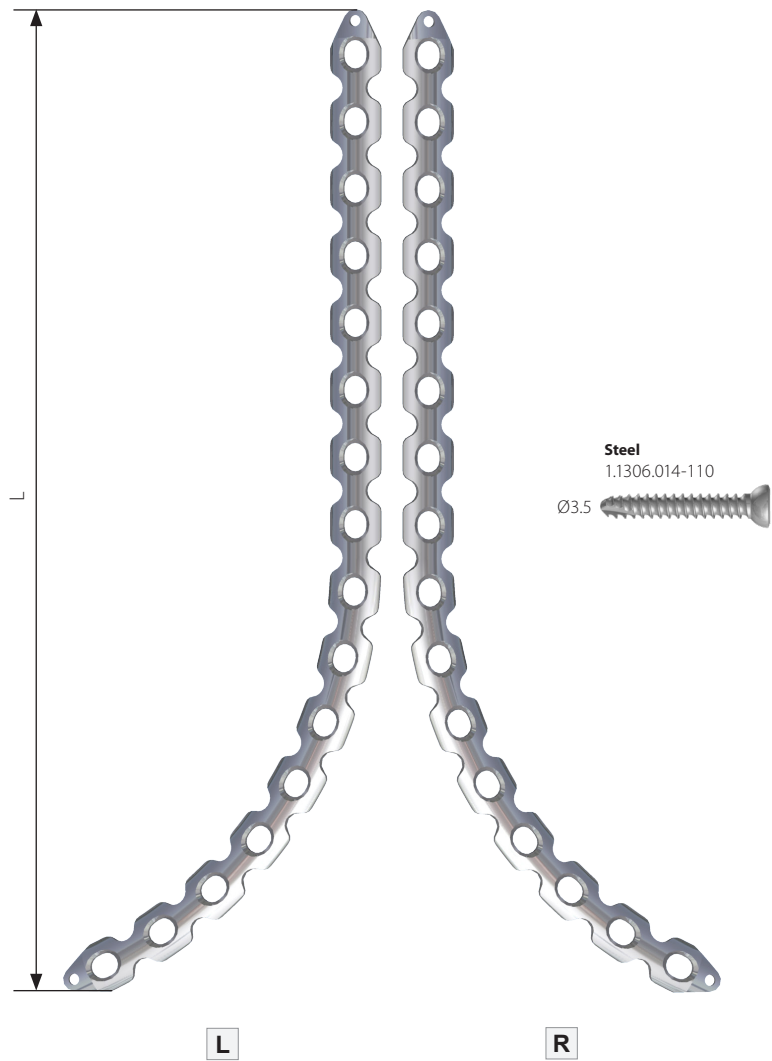

5.0ChLP symphysic plate

Catalogue No.

O	L [mm]	Steel
4	56.5	1.7046.104
6	83	1.7046.106

O - holes number in the plate



Reconstruction plate

Left

Catalogue No.

O	L [mm]	Steel
16	44.5x134.6	1.7151.016

O - holes number in the plate

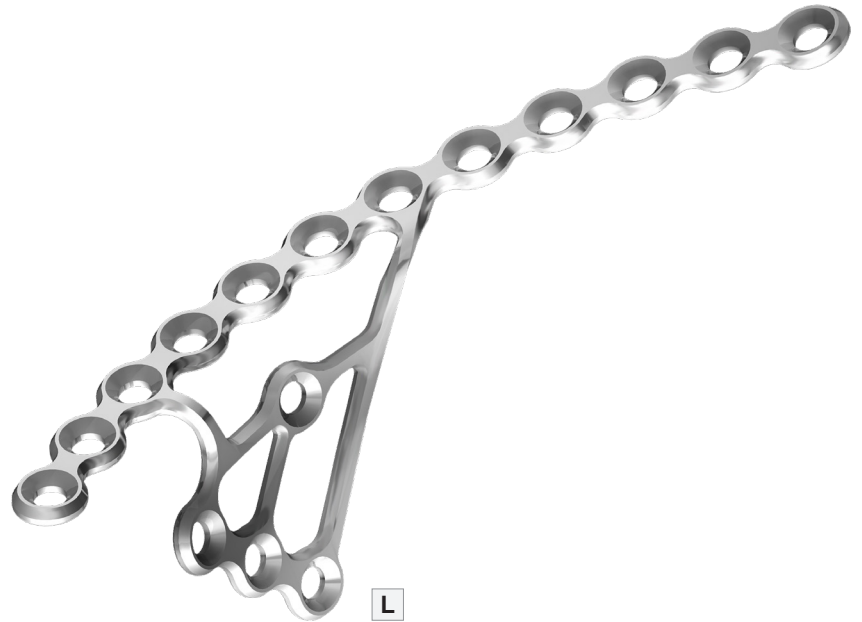

Right

Catalogue No.

O	L [mm]	Steel
16	44.5x134.6	1.7152.016

O - holes number in the plate

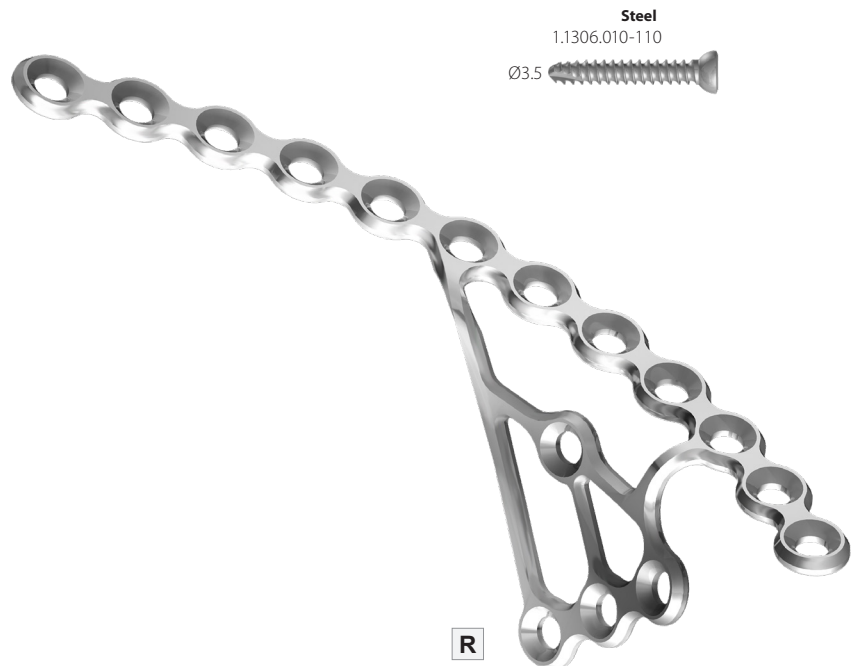

5.0ChLP reconstruction plate

Left

Catalogue No.		
O	L [mm]	Steel
16	44.5x134.6	1.7251.016

O - holes number in the plate



Right

Catalogue No.		
O	L [mm]	Steel
16	44.5x134.6	1.7252.016

O - holes number in the plate

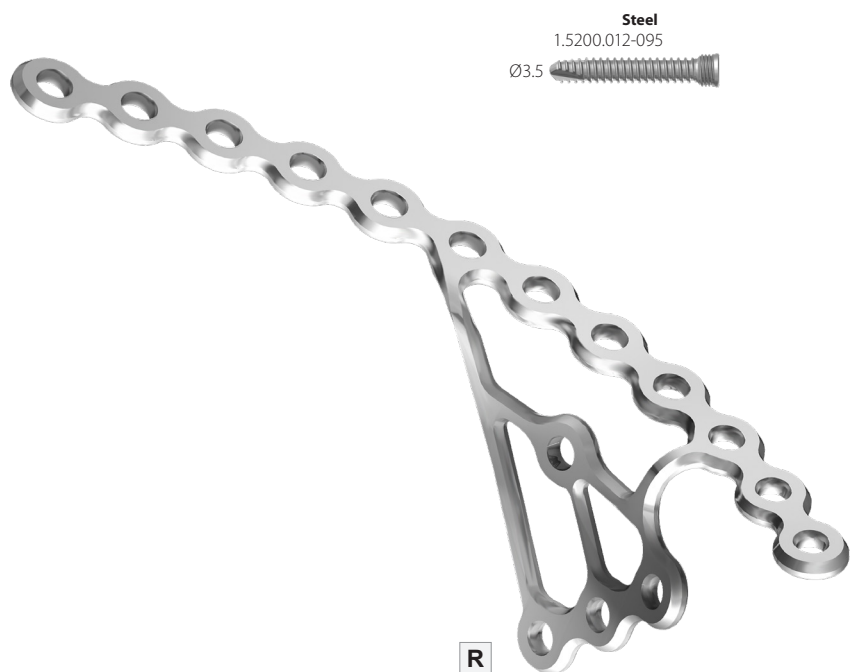

Reconstruction elastic plate 3.5

Catalogue No.

O	L [mm]	Steel
1	18.5	1.3120.001
2	31.5	1.3120.002
3	44.5	1.3120.003

O - holes number in the plate

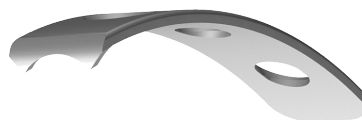

Reconstruction plate

Left

Catalogue No.	
O	Steel
18	1.7151.118

O - holes number in the plate

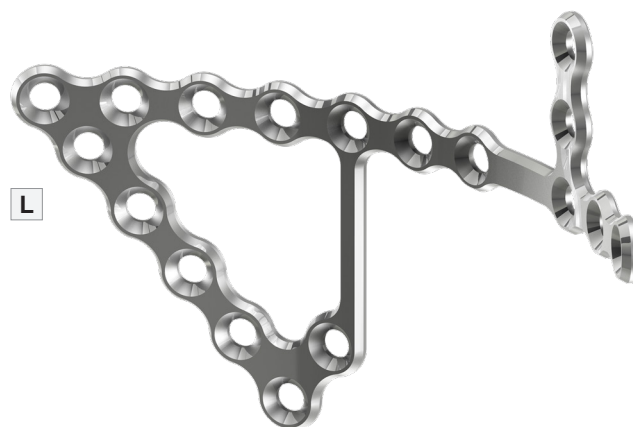

Steel
1.1306.014-110



Right

Catalogue No.	
O	Steel
18	1.7152.118

O - holes number in the plate

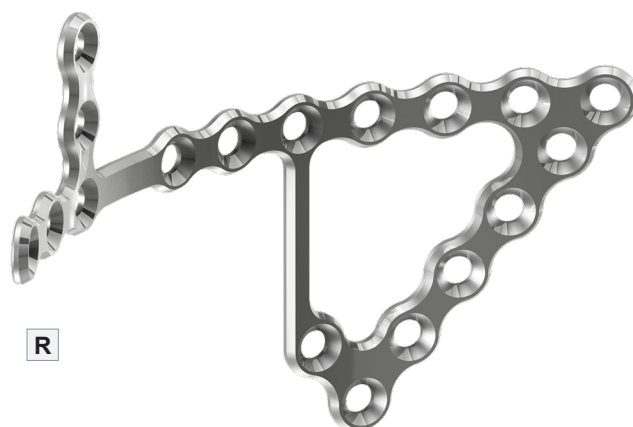

Reconstruction plate

Left

Catalogue No.	
O	Steel
20	1.7152.120

O	Steel
20	1.7152.120

O - holes number in the plate



Steel
1.1306.014-110

Ø3.5 

Right

Catalogue No.	
O	Steel
20	1.7151.120

O	Steel
20	1.7151.120

O - holes number in the plate



R

Reconstruction plate

Left

Catalogue No.	
O	Steel
18	1.7152.018

O - holes number in the plate



Right

Catalogue No.	
O	Steel
18	1.7151.018

O - holes number in the plate

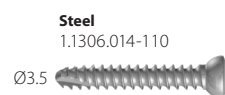

Reconstruction plate

Catalogue No.

O	Steel
10	1.7151.110

O - holes number in the plate

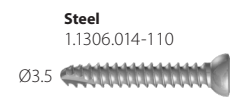

5.0ChLP self-tapping screw 3.5

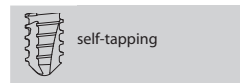
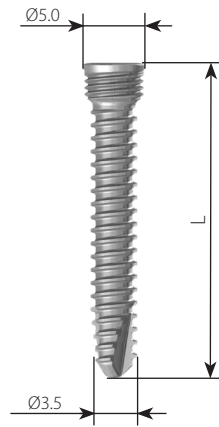

Catalogue No.

L [mm]	Steel
12	1.5200.012
14	1.5200.014
16	1.5200.016
18	1.5200.018
20	1.5200.020
22	1.5200.022
24	1.5200.024
26	1.5200.026
28	1.5200.028
30	1.5200.030
32	1.5200.032
34	1.5200.034
36	1.5200.036
38	1.5200.038
40	1.5200.040
45	1.5200.045
50	1.5200.050
55	1.5200.055
60	1.5200.060
65	1.5200.065
70	1.5200.070
75	1.5200.075
80	1.5200.080
85	1.5200.085
90	1.5200.090
95	1.5200.095

Cortical self-tapping screw 4.5

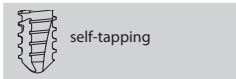
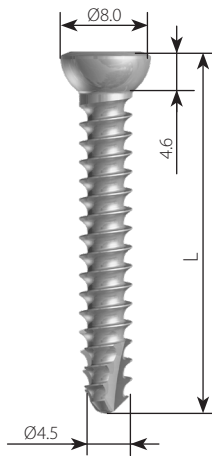

Catalogue No.

L [mm]	Steel
16	1.1471.016
18	1.1471.018
20	1.1471.020
22	1.1471.022
24	1.1471.024
26	1.1471.026
28	1.1471.028
30	1.1471.030
32	1.1471.032
34	1.1471.034
36	1.1471.036
38	1.1471.038
40	1.1471.040
45	1.1471.044
50	1.1471.050
55	1.1471.055
60	1.1471.060
65	1.1471.065
70	1.1471.070
75	1.1471.075
80	1.1471.080
85	1.1471.085
90	1.1471.090
95	1.1471.095
100	1.1471.100

Cortical self-tapping screw 3.5

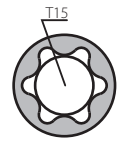
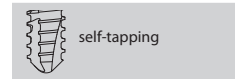
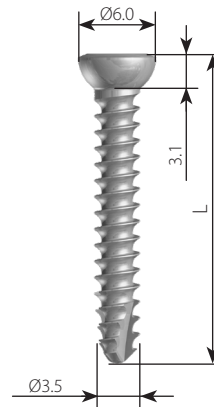

Catalogue No.

L [mm]	Steel
10	1.1306.010
12	1.1306.012
14	1.1306.014
16	1.1306.016
18	1.1306.018
20	1.1306.020
22	1.1306.022
24	1.1306.024
26	1.1306.026
28	1.1306.028
30	1.1306.030
32	1.1306.032
34	1.1306.034
36	1.1306.036
38	1.1306.038
40	1.1306.040
45	1.1306.045
50	1.1306.050
55	1.1306.055
60	1.1306.060
65	1.1306.065
70	1.1306.070
75	1.1306.075
80	1.1306.080
85	1.1306.085
90	1.1306.090
95	1.1306.095
100	1.1306.100
105	1.1306.105
110	1.1306.110

Stand for screws

No.	Name	Catalogue No.	Pcs.
1	Stand for screws	40.6030.100	1
2	Container solid bottom 1/2 306x272x184mm	12.0751.103	1
3	Perforated aluminum lid 1/2 306x272x15mm Gray	12.0751.200	1

40.6030.000

implants not included

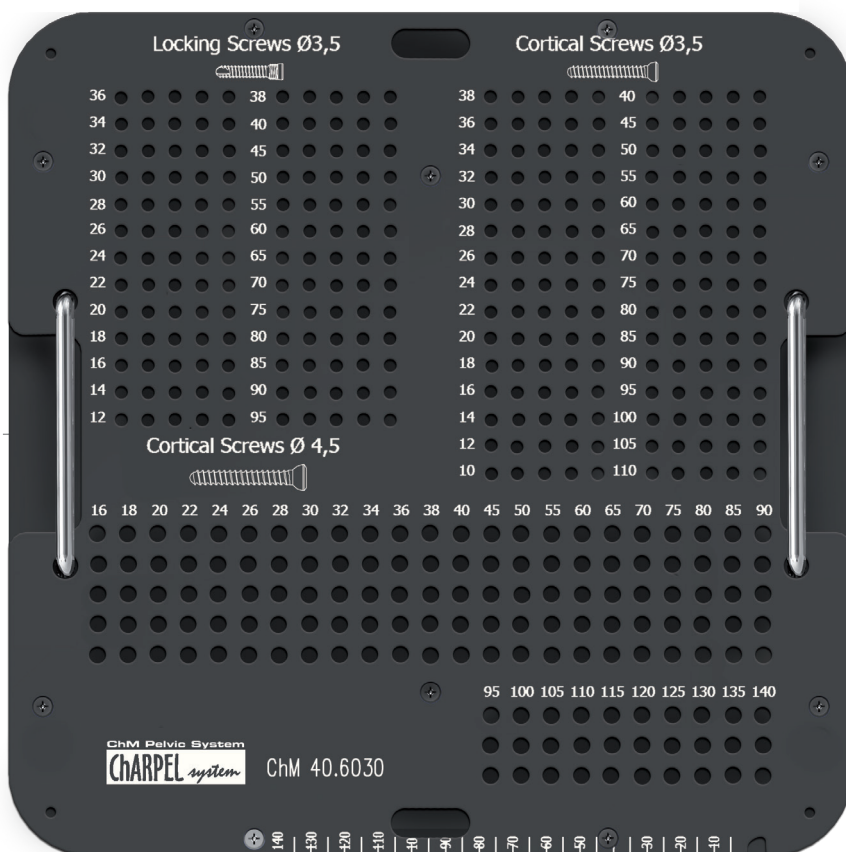

40.6030.100



40.6030.000

Palette for implants

No.	Name	Catalogue No.	Pcs.
1	Stand for implants	40.6018.300	1
2	Container solid bottom 1/1 595x275x86mm	12.0750.100	1
3	Perforated aluminum lid 1/1 595x275x15mm Gray Покрышка алюминиевая перфорированная 1/1 595x275x15мм Серая	12.0750.200	1

40.6000.540

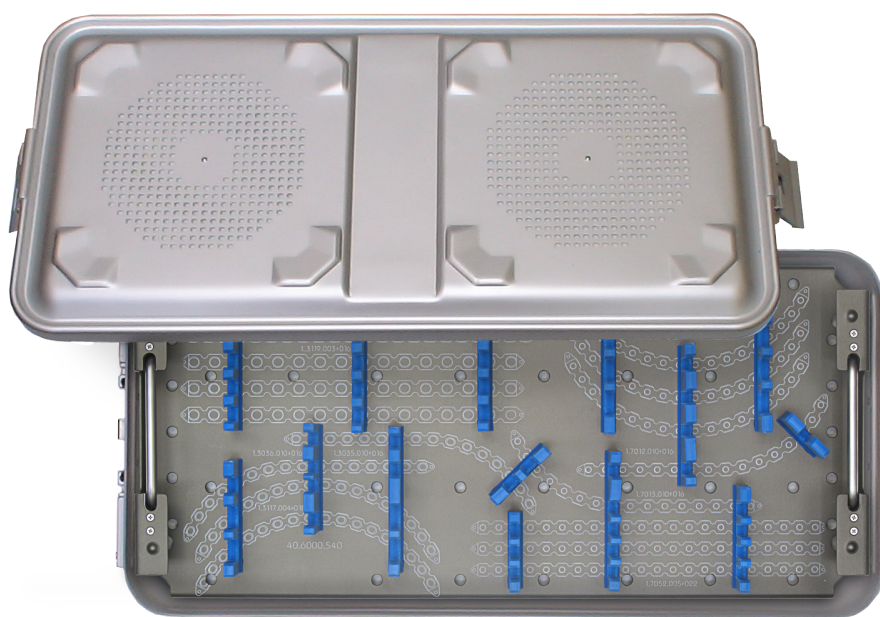







40.6000.540



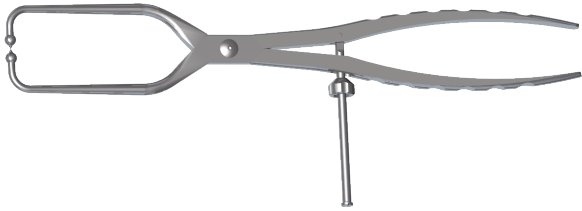
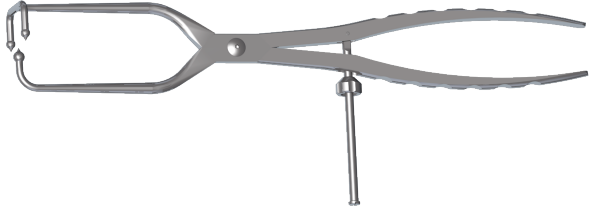
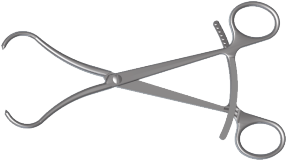

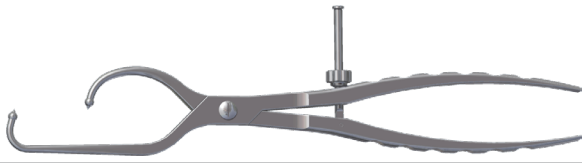
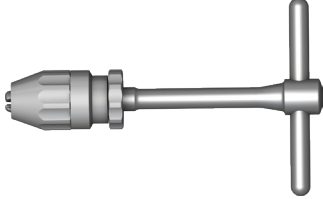
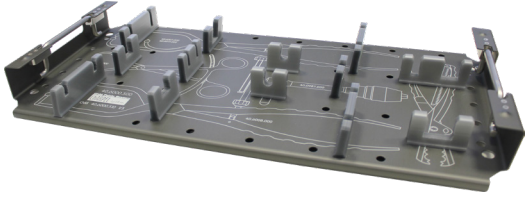
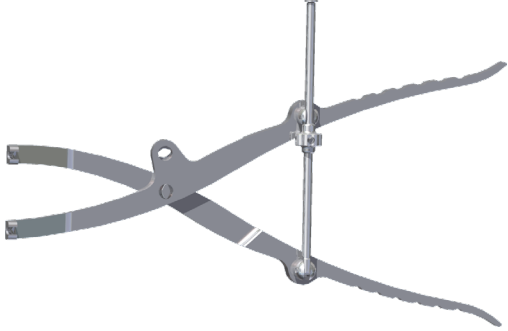

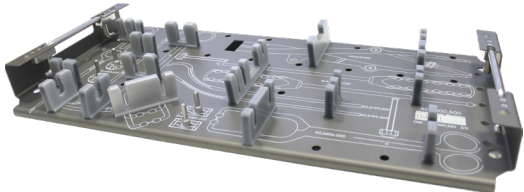







Plate trials













No.	Catalogue no.	Name
1	40.6019.000	Plate 1.3035 trial
2	40.6020.000	Plate 1.3036 trial
3	40.6021.000	Plate 1.3117 trial
4	40.6022.000	Plate 1.3118 trial
5	40.6023.000	Plate 1.3119 trial

III. INSTRUMENTS



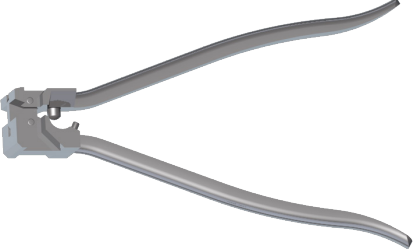

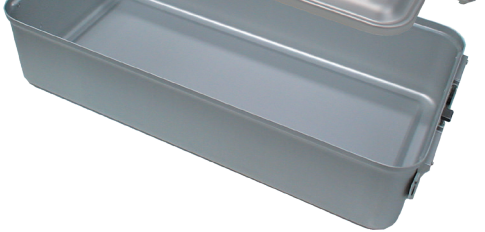

III.1. INSTRUMENT SET FOR PELVIC FIXATION 40.6000.500



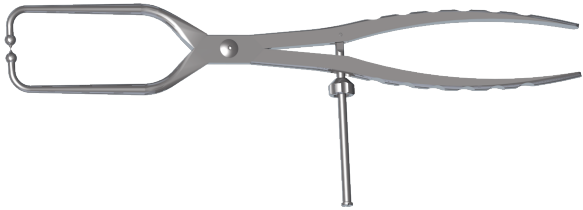
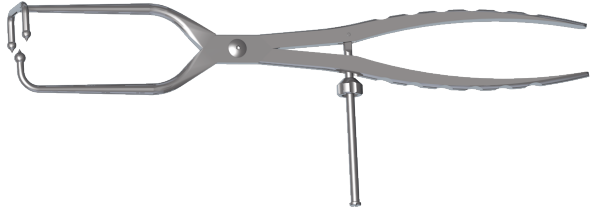
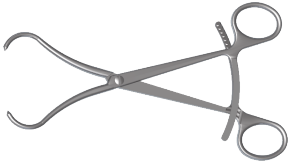

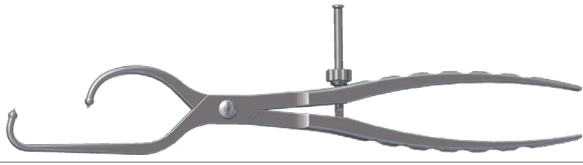
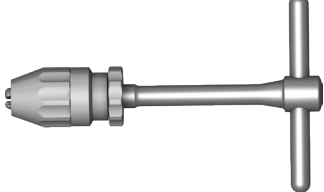
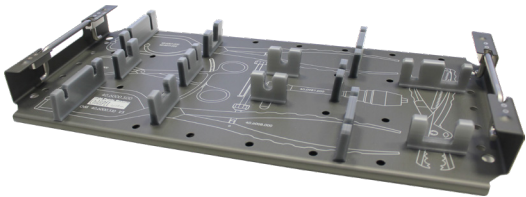







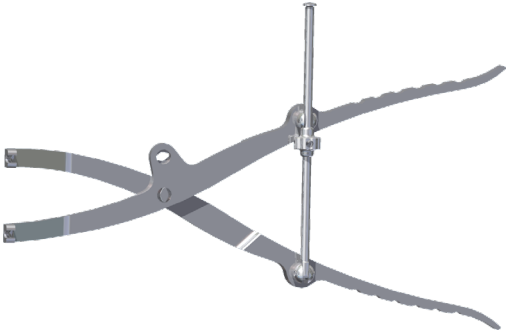

No.		Name	Catalogue No.	Pcs.
1		Reduction long forceps 1x1	40.6007.000	1
2		Reduction long forceps 2x1	40.6008.000	1
3		Reduction ratchet pliers with sharp tips	40.6009.000	1
4		Compression forceps	40.6016.000	1
5		Reduction asymmetric pliers	40.6017.000	1
6		STEINMANN handle	40.0987.200	1
7		Stand for instrument set for pelvic fixation	40.6018.100	1
8		Retractor for bone straight	40.6001.000	1
9		Temporary persuader	40.6002.000	2
10		Retractor for bone with handle	40.6003.000	1

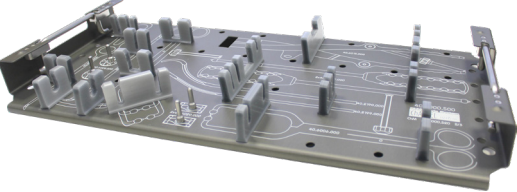

No.	Name	Catalogue No.	Pcs.
11	 Angular reduction curved forceps long	40.6004.000	1
12	 Angular reduction curved forceps short	40.6005.000	1
13	 Angular reduction straight forceps	40.6006.000	1
14	 Latch swinging round	40.6028.000	2
15	 Latch swinging rectangular	40.6029.000	2
16	 Reduction regulating forceps	40.6015.000	1
17	 Elevator 24	40.2199.001	1
18	 LANGE-HOHMANN elevator modif. 30	40.2190.001	1
19	 Stand for instrument set for pelvic fixation	40.6018.150	1
20	Drill 2.5/250	40.2049.251	2
21	Drill 3.2/250	40.2053.251	2
22	 Drill 3.5/250	40.1363.251	2
23	Drill 4.5/250	40.1387.251	2
24	 Kirschner wire 2.0/220	40.4815.220	4
25	 Drill with scale 2.8/250	40.5653.251	2
26	 Compression pin 6x200	40.6035.200	2
27	 Setting-compressing screw 2.8/180	40.5674.128	2
28	 Guide sleeve 5.0/2.8	40.5673.028	4
29	 Torque limiting ratchet handle 2Nm	40.6652.000	1

No.		Name	Catalogue No.	Pcs.
30		Screwdriver tip T15	40.5677.150	1
31		Screwdriver tip T 25-3/16	40.5684.150	1
32		Compression guide 2.5	40.4804.025	1
33		Holder for screws 4.5	40.6027.000	1
34		Holder for screws 3.5	40.6026.000	1
35		Cortical tap HA3.5	40.5926.000	1
36		Cortical tap HA34.5	40.5647.100	1
37		Bender for reconstruction plates straight	40.6013.000	2
38		Multiplane bender for reconstruction plates	40.6014.000	1
39		Hole depth measure L-150mm	40.2667.100	1
40		Stand for instrument set for pelvic fixation	40.6018.200	1
41		Container with solid bottom 1/1 595x275x135mm	12.0750.102	2
42		Perforated aluminum lid 1/1 595x275x15mm Gray	12.0750.200	2





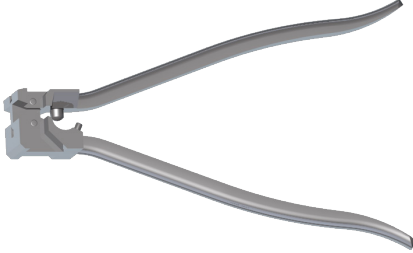
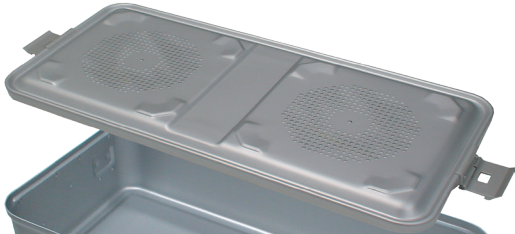

III.2. INSTRUMENT SET FOR PELVIC FIXATION 40.6000.600



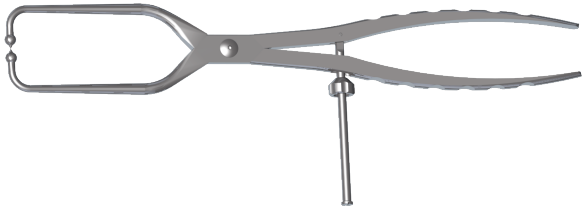
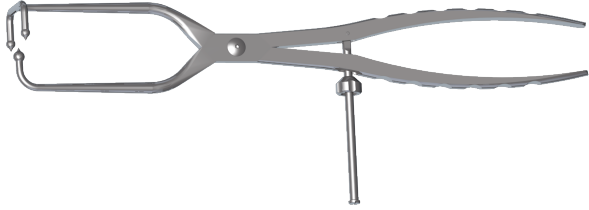
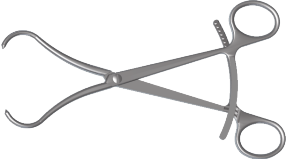

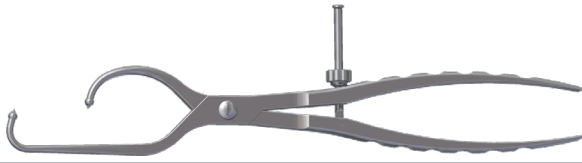
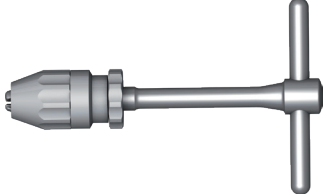
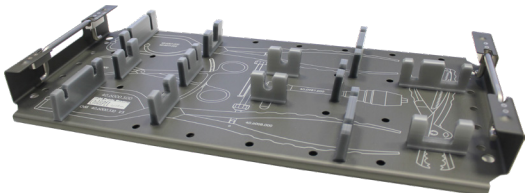

No.		Name	Catalogue No.	Pcs.
1		Reduction long forceps 1x1	40.6007.000	1
2		Reduction long forceps 2x1	40.6008.000	1
3		Reduction ratchet pliers with sharp tips	40.6009.000	1
4		Compression forceps	40.6016.000	1
5		Reduction asymmetric pliers	40.6017.000	1
6		STEINMANN handle	40.0987.200	1
7		Stand for instrument set for pelvic fixation	40.6018.100	1
8		Retractor for bone straight	40.6001.000	1
9		Temporary persuader	40.6002.000	2
10		Retractor for bone with handle	40.6003.000	1
11		Angular reduction curved forceps long	40.6004.000	1

No.	Name	Catalogue No.	Pcs.
12	 Angular reduction curved forceps short	40.6005.000	1
13	 Angular reduction straight forceps	40.6006.000	1
14	 Latch swinging round	40.6028.000	2
15	 Latch swinging rectangular	40.6029.000	2
16	 Reduction regulating forceps	40.6015.000	1
17	 Elevator 24	40.2199.001	1
18	 LANGE-HOHMANN elevator modif. 30	40.2190.001	1
19	 Stand for instrument set for pelvic fixation	40.6018.150	1
20	Drill 2.5/250	40.2049.251	2
21	Drill 3.2/250	40.2053.251	2
22	 Drill 3.5/250	40.1363.251	2
23	Drill 4.5/250	40.1387.251	2
24	 Kirschner wire 2.0/220	40.4815.220	4
25	 Compression pin 6x200	40.6035.200	2
26	 Torque limiting ratchet handle 2Nm	40.6652.000	1
27	Screwdriver tip T15	40.5677.150	1
28	 Screwdriver tip T 25-3/16	40.5684.150	1
29	 Compression guide 2.5	40.4804.025	1
30	Holder for screws 4.5	40.6027.000	1
31	 Holder for screws 3.5	40.6026.000	1

No.		Name	Catalogue No.	Pcs.
32		Cortical tap HA3.5	40.5926.000	1
33		Cortical tap HA34.5	40.5647.100	1
34		Hole depth measure L-150mm	40.2667.100	1
35		Bender for reconstruction plates straight	40.6013.000	2
36		Multiplane bender for reconstruction plates	40.6014.000	1
37		Stand for instrument set for pelvic fixation	40.6018.200	1
38		Container with solid bottom 1/1 595x275x135mm	12.0750.102	2
39		Perforated aluminum lid 1/1 595x275x15mm Gray	12.0750.200	2

III.3. INSTRUMENT SET FOR PELVIC FIXATION – REPOSITIONING 40.6000.700

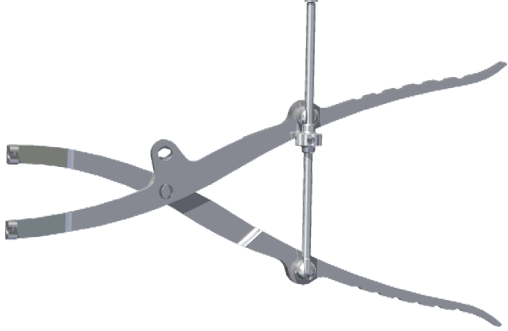
No.		Name	Catalogue No.	Pcs.
1		Reduction long forceps 1x1	40.6007.000	1
2		Reduction long forceps 2x1	40.6008.000	1
3		Reduction ratchet pliers with sharp tips	40.6009.000	1
4		Compression forceps	40.6016.000	1
5		Reduction asymmetric pliers	40.6017.000	1
6		STEINMANN handle	40.0987.200	1
7		Stand for instrument set for pelvic fixation	40.6018.100	1
8		Retractor for bone straight	40.6001.000	1
9		Temporary persuader	40.6002.000	2
10		Retractor for bone with handle	40.6003.000	1

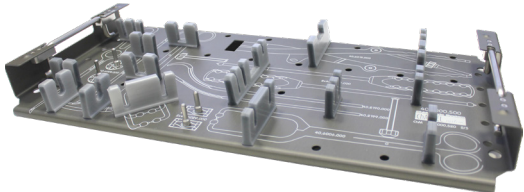
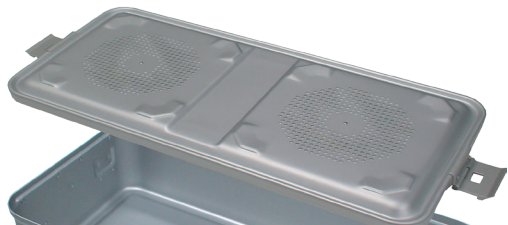
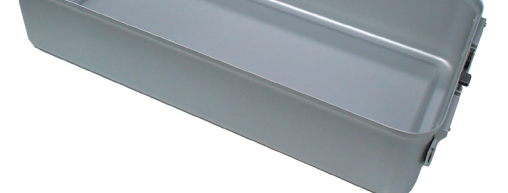
No.	Name	Catalogue No.	Pcs.
11	 Angular reduction curved forceps long	40.6004.000	1
12	 Angular reduction curved forceps short	40.6005.000	1
13	 Angular reduction straight forceps	40.6006.000	1
14	 Latch swinging round	40.6028.000	2
15	 Latch swinging rectangular	40.6029.000	2
16	 Reduction regulating forceps	40.6015.000	1
17	 Elevator 24	40.2199.001	1
18	 LANGE-HOHMANN elevator modif. 30	40.2190.001	1
19	 Stand for instrument set for pelvic fixation	40.6018.150	1
20	 Container with solid bottom 1/1 595x275x135mm	12.0750.102	1
21	 Perforated aluminum lid 1/1 595x275x15mm gray	12.0750.200	1