

II. IMPLANTY

ChARPEL płytki rekonstrukcyjna 3,5mm prosta

Nr katalogowy

O	L [mm]	Stal
5	66	1.7052.005
6	78	1.7052.006
7	90	1.7052.007
8	102	1.7052.008
9	114	1.7052.009
10	126	1.7052.010
12	150	1.7052.012
14	174	1.7052.014
16	198	1.7052.016
18	222	1.7052.018
20	246	1.7052.020
22	270	1.7052.022

O - liczba wszystkich otworów gwintowanych w płytce

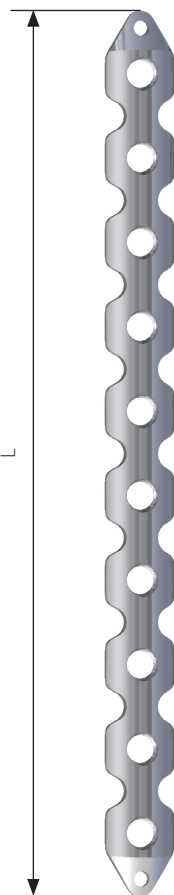

ChARPEL płytki rekonstrukcyjna 3,5 prosta

Nr katalogowy

O	L [mm]	Stal
5	66	1.3118.005
6	78	1.3118.006
7	90	1.3118.007
8	102	1.3118.008
9	114	1.3118.009
10	126	1.3118.010
12	150	1.3118.012
14	174	1.3118.014
16	198	1.3118.016
18	222	1.3118.018
20	246	1.3118.020
22	270	1.3118.022

O - liczba otworów w płytce

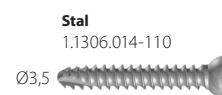
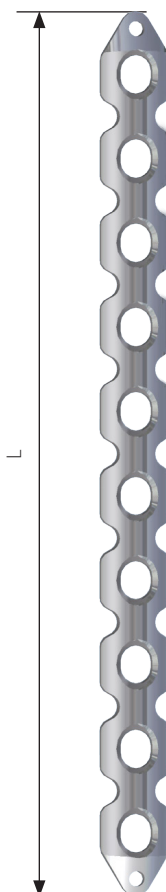

ChARPEL płytka rekonstrukcyjna 4,5 prosta

Nr katalogowy

O	L [mm]	Stal
3	52	1.3119.003
4	68	1.3119.004
5	84	1.3119.005
6	100	1.3119.006
7	116	1.3119.007
8	132	1.3119.008
9	148	1.3119.009
10	164	1.3119.010
11	180	1.3119.011
12	196	1.3119.012
13	212	1.3119.013
14	228	1.3119.014
15	244	1.3119.015
16	260	1.3119.016

O - liczba otworów w płytce

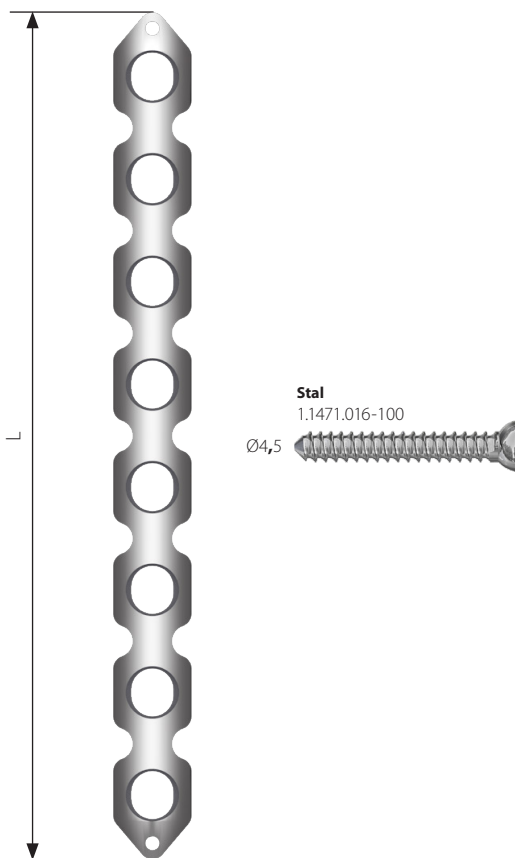

ChARPEL płytki rekonstrukcyjna R108 4,5mm

Nr katalogowy

O	L [mm]	Stal
4	72	1.3037.004
6	102	1.3037.006
8	129	1.3037.008
10	154	1.3037.010
12	175	1.3037.012
14	193	1.3037.014
16	208	1.3037.016

O - liczba otworów w płytce

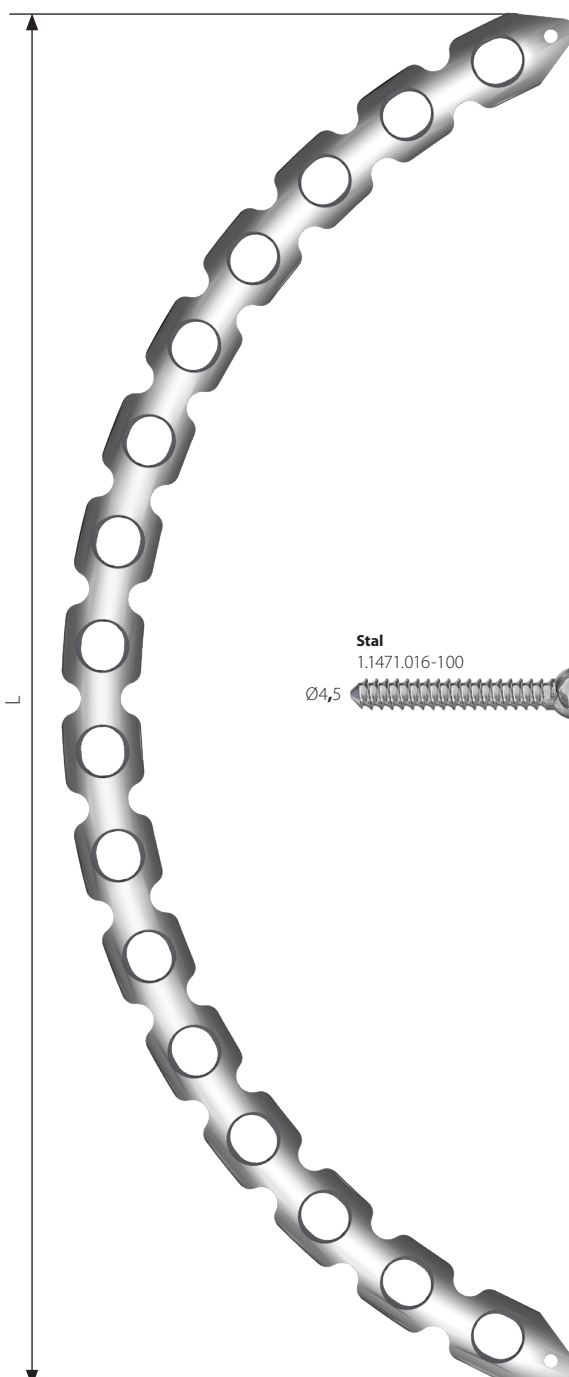

ChARPEL płytki rekonstrukcyjna 3,5mm R100

Nr katalogowy

O	L [mm]	Stal
4	59	1.7053.004
6	82	1.7053.006
8	104	1.7053.008
10	124	1.7053.010
12	143	1.7053.012
14	159	1.7053.014
16	173	1.7053.016
18	185	1.7053.018

O - liczba wszystkich otworów gwintowanych w płytce

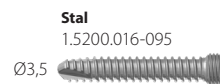
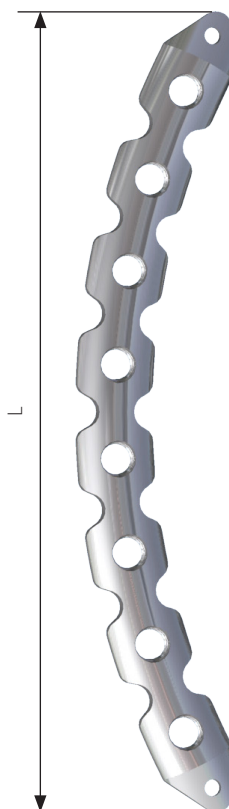

ChARPEL płytki rekonstrukcyjna R100 3,5mm

Nr katalogowy

O	L [mm]	Stal
4	59	1.3117.004
6	82	1.3117.006
8	104	1.3117.008
10	124	1.3117.010
12	143	1.3117.012
14	159	1.3117.014
16	173	1.3117.016
18	185	1.3117.018

O - liczba otworów w płytce

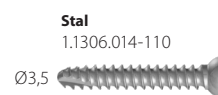
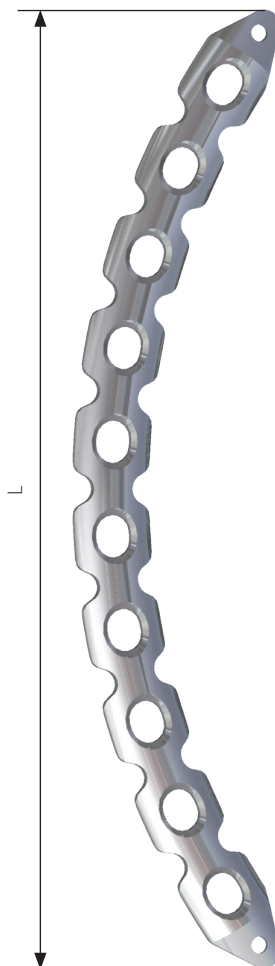

ChARPEL płytka rekonstrukcyjna J

Lewa		
Nr katalogowy		
O	L [mm]	Stal
10	123	1.7013.010
12	143	1.7013.012
14	163	1.7013.014
16	181	1.7013.016

Prawa		
Nr katalogowy		
O	L [mm]	Stal
10	123	1.7012.010
12	143	1.7012.012
14	163	1.7012.014
16	181	1.7012.016

O - liczba wszystkich otworów gwintowanych w płytce

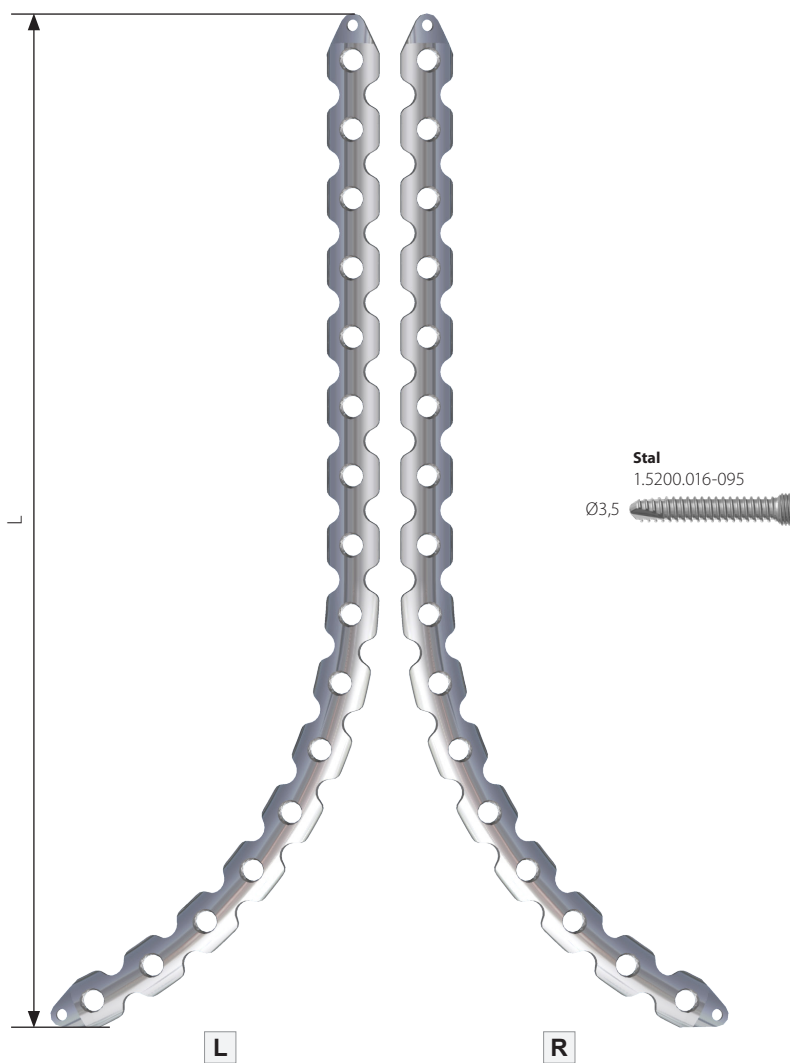

ChARPEL płytka rekonstrukcyjna J

Lewa		
Nr katalogowy		
O	L [mm]	Stal
10	123	1.3036.010
12	143	1.3036.012
14	163	1.3036.014
16	181	1.3036.016

Prawa		
Nr katalogowy		
O	L [mm]	Stal
10	123	1.3035.010
12	143	1.3035.012
14	163	1.3035.014
16	181	1.3035.016

O - liczba otworów w płytce

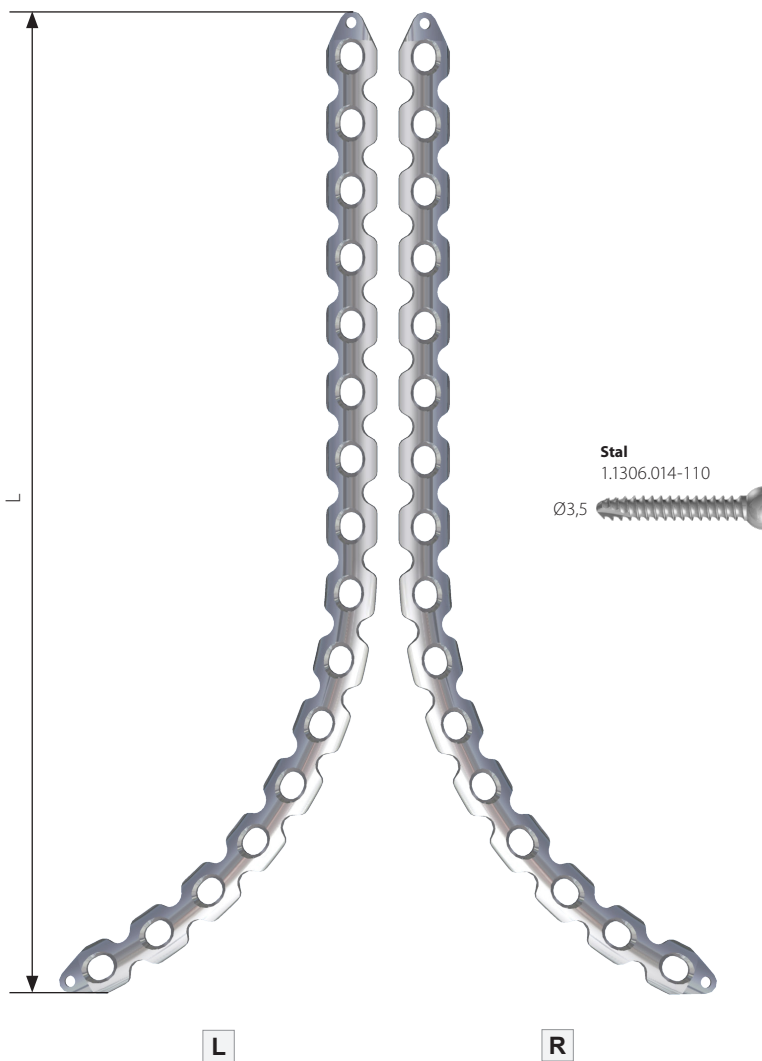

5,0ChLP płytka spoiniowa

Nr katalogowy

O	L [mm]	STAL
4	56,5	1.7046.104
6	83	1.7046.106

O - liczba otworów w płytce



Płytki rekonstrukcyjne

Lewa

Nr katalogowy

O	L [mm]	STAL
16	44,5x134,6	1.7151.016

O - liczba otworów w płytce

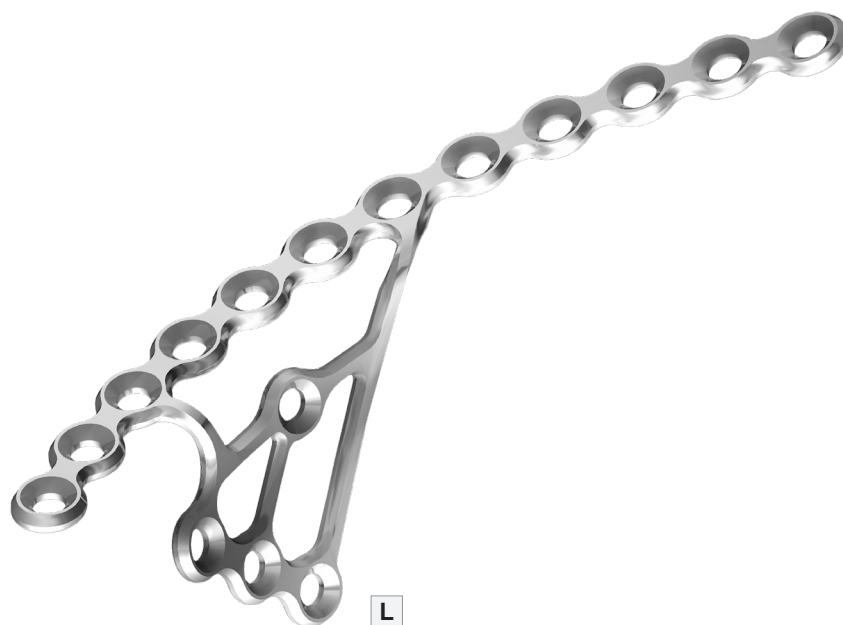

Prawa

Nr katalogowy

O	L [mm]	STAL
16	44,5x134,6	1.7152.016

O - liczba otworów w płytce

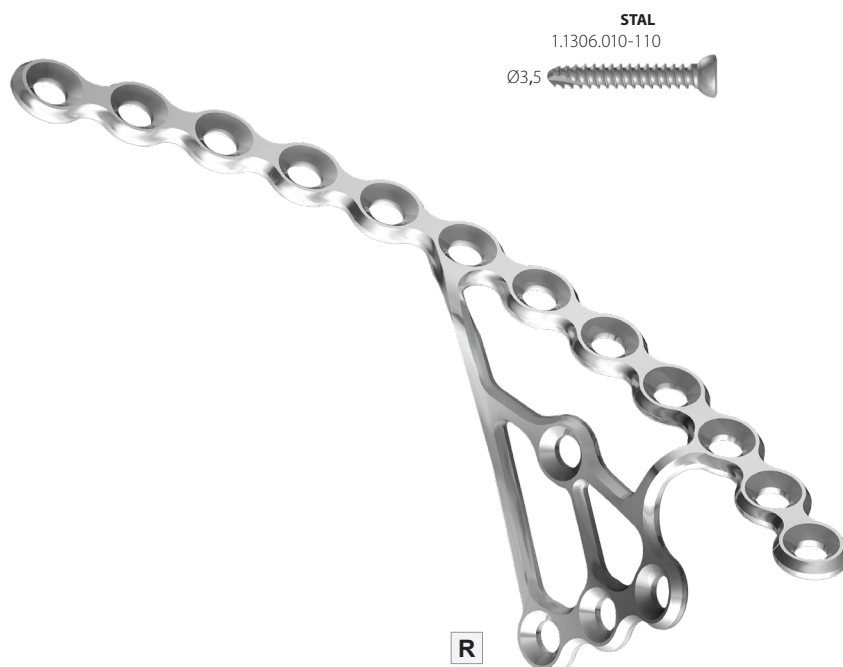

5,0ChLP płytka rekonstrukcyjna

Lewa

Nr katalogowy

O	L [mm]	STAL
16	44,5x134,6	1.7251.016

O - liczba otworów w płytce



Prawa

Nr katalogowy

O	L [mm]	STAL
16	44,5x134,6	1.7252.016

O - liczba otworów w płytce

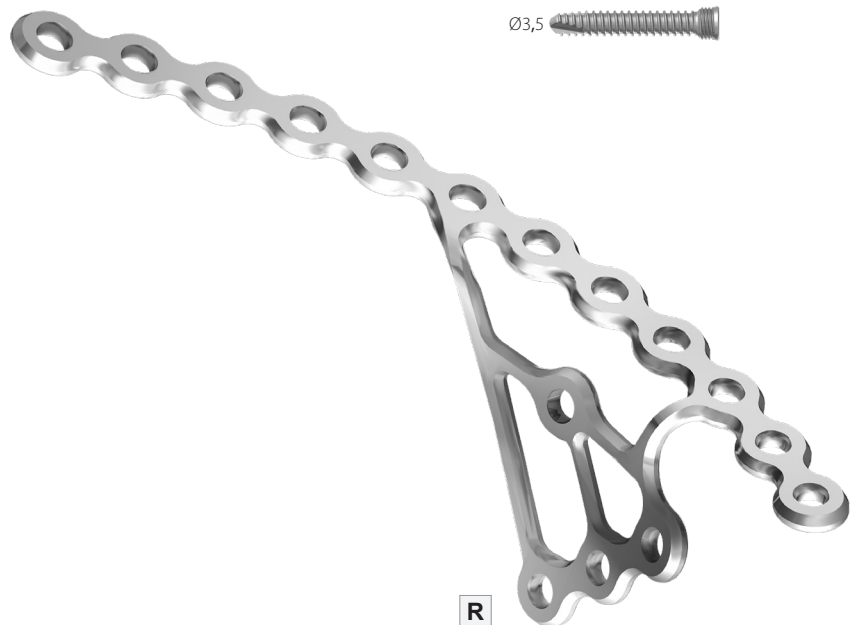

Płytki rekonstrukcyjne sprężyste 3,5

Nr katalogowy

O	L [mm]	STAL
1	18,5	1.3120.001
2	31,5	1.3120.002
3	44,5	1.3120.003

O - liczba otworów w płytce

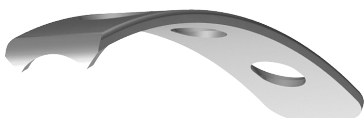
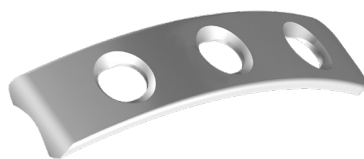

Płytki rekonstrukcyjne

Lewa

Nr katalogowy	
O	Stal
18	1.7151.118

O - liczba otworów w płytce

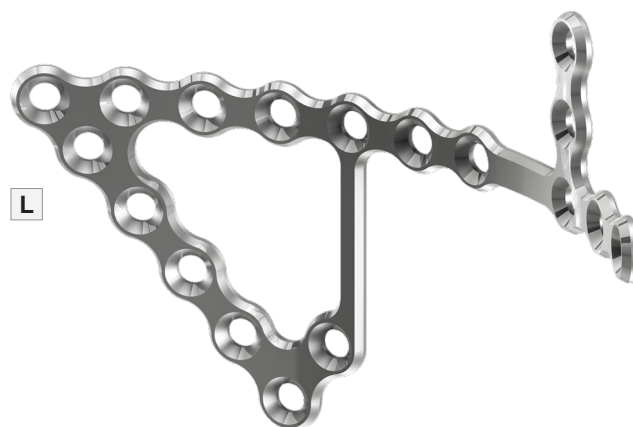

L

Stal
1.1306.014-110



Prawa

Nr katalogowy	
O	Stal
18	1.7152.118

O - liczba otworów w płytce

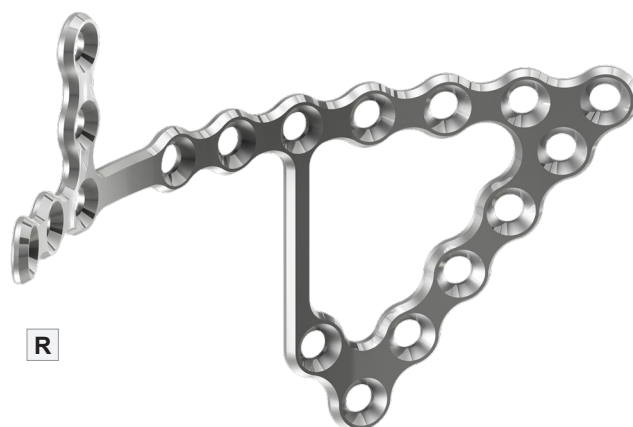

R

Płytki rekonstrukcyjne

Lewa

Nr katalogowy

O	Stal
20	1.7152.120

O - liczba otworów w płytce



Stal
1.1306.014-110



Prawa

Nr katalogowy

O	Stal
20	1.7151.120

O - liczba otworów w płytce



R

Płytki rekonstrukcyjne

Lewa

Nr katalogowy	
O	Stal
18	1.7152.018

O - liczba otworów w płytce



Prawa

Nr katalogowy	
O	Stal
18	1.7151.018

O - liczba otworów w płytce

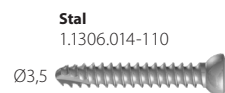

Płytki rekonstrukcyjne

Nr katalogowy

O	Stal
10	1.7151.110

O - liczba otworów w płytce

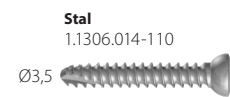

5,0ChLP wkręt samogwintujący 3,5

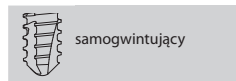
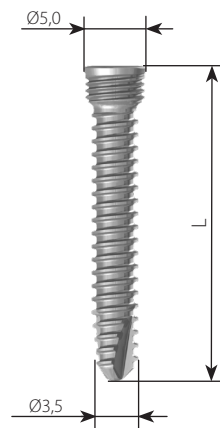

Nr katalogowy

L [mm]	Stal
12	1.5200.012
14	1.5200.014
16	1.5200.016
18	1.5200.018
20	1.5200.020
22	1.5200.022
24	1.5200.024
26	1.5200.026
28	1.5200.028
30	1.5200.030
32	1.5200.032
34	1.5200.034
36	1.5200.036
38	1.5200.038
40	1.5200.040
45	1.5200.045
50	1.5200.050
55	1.5200.055
60	1.5200.060
65	1.5200.065
70	1.5200.070
75	1.5200.075
80	1.5200.080
85	1.5200.085
90	1.5200.090
95	1.5200.095

Wkręt korowy samogwintujący 4,5

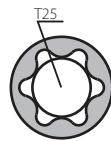
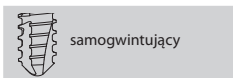
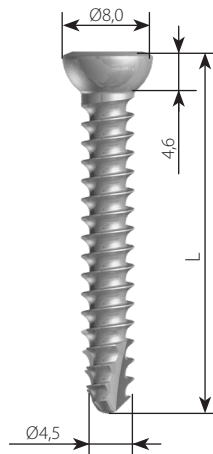

Nr katalogowy

L [mm]	Stal
16	1.1471.016
18	1.1471.018
20	1.1471.020
22	1.1471.022
24	1.1471.024
26	1.1471.026
28	1.1471.028
30	1.1471.030
32	1.1471.032
34	1.1471.034
36	1.1471.036
38	1.1471.038
40	1.1471.040
45	1.1471.044
50	1.1471.050
55	1.1471.055
60	1.1471.060
65	1.1471.065
70	1.1471.070
75	1.1471.075
80	1.1471.080
85	1.1471.085
90	1.1471.090
95	1.1471.095
100	1.1471.100

Wkręt korowy samogwintujący 3,5

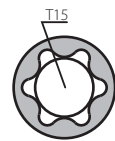
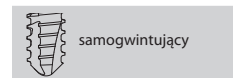
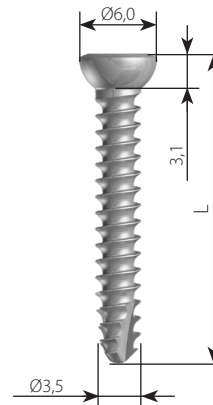

Nr katalogowy

L [mm]	Stal
10	1.1306.010
12	1.1306.012
14	1.1306.014
16	1.1306.016
18	1.1306.018
20	1.1306.020
22	1.1306.022
24	1.1306.024
26	1.1306.026
28	1.1306.028
30	1.1306.030
32	1.1306.032
34	1.1306.034
36	1.1306.036
38	1.1306.038
40	1.1306.040
45	1.1306.045
50	1.1306.050
55	1.1306.055
60	1.1306.060
65	1.1306.065
70	1.1306.070
75	1.1306.075
80	1.1306.080
85	1.1306.085
90	1.1306.090
95	1.1306.095
100	1.1306.100
105	1.1306.105
110	1.1306.110

Statyw na wkręty

Lp.	Nazwa	Nr katalogowy	Szt.
1	Wkładka statywu do wkrętów	40.6030.100	1
2	Kontener z litym dnem 1/2 306x272x184mm	12.0751.103	1
3	Pokrywa aluminiowa perfor.1/2 306x272x15mm Szara	12.0751.200	1

40.6030.000

bez implantów

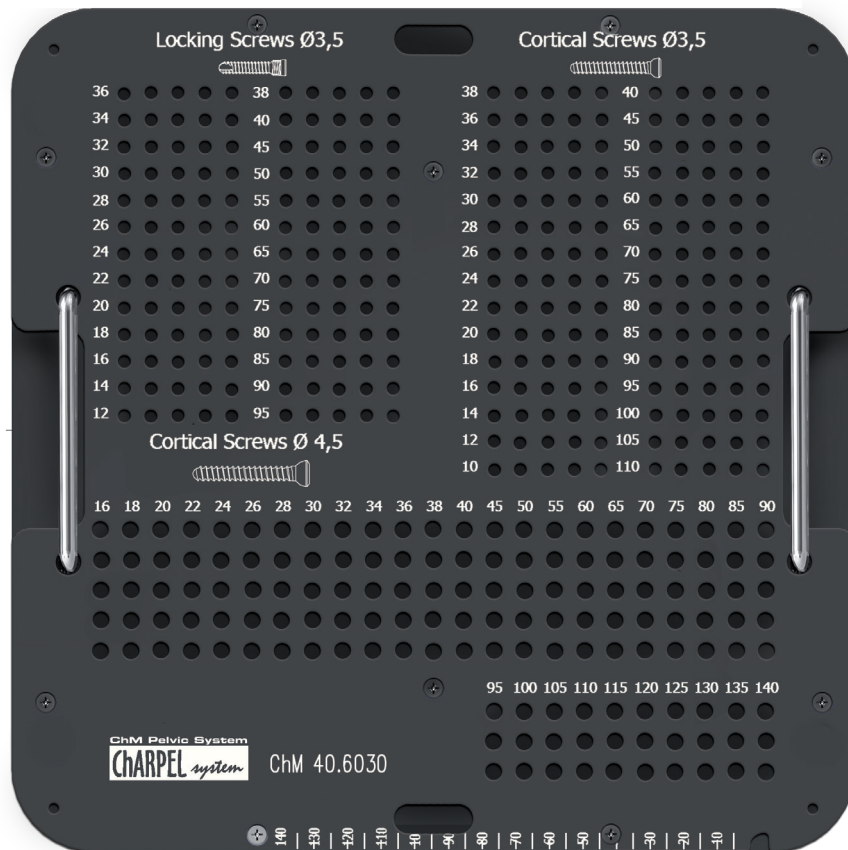

40.6030.100



40.6030.000

Paleta na implanty

Lp.	Nazwa	Nr katalogowy	Szt.
1	Statyw na implanty	40.6018.300	1
2	Kontener z litym dnem 1/1 595x275x86mm	12.0750.100	1
3	Pokrywa aluminiowa perfor.1/1 595x275x15mm Szara Покрышка алюминиевая перфорированная 1/1 595x275x15мм Серая	12.0750.200	1

40.6000.540

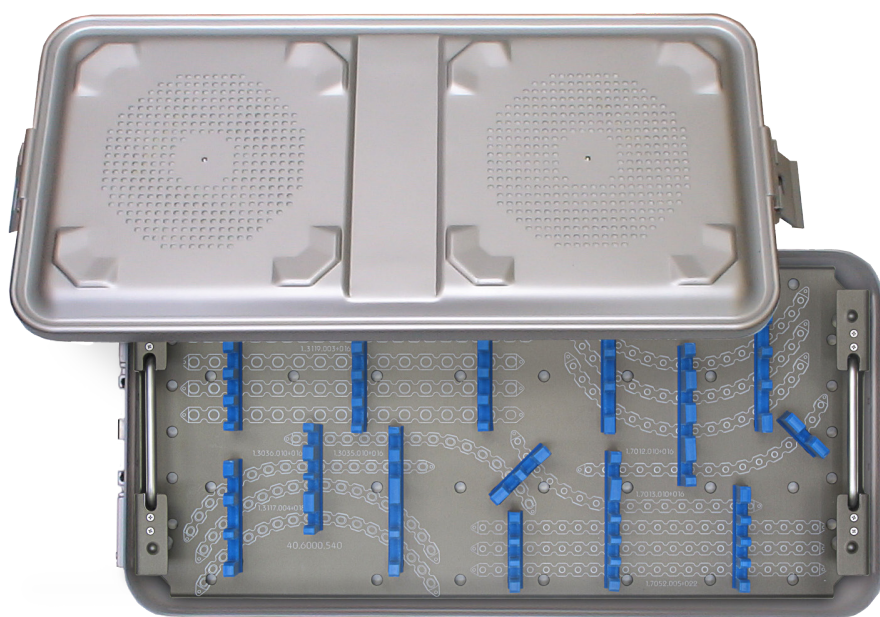







40.6000.540



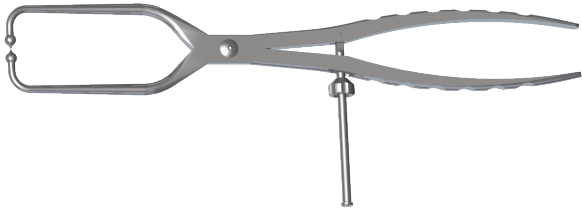
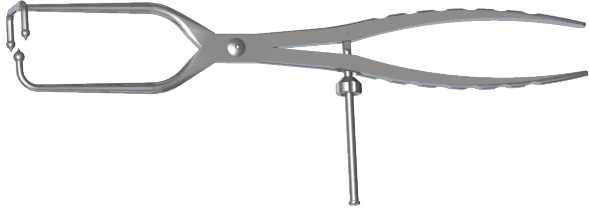
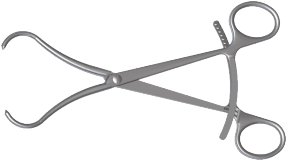

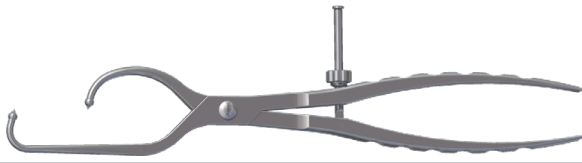
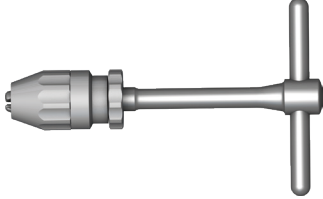
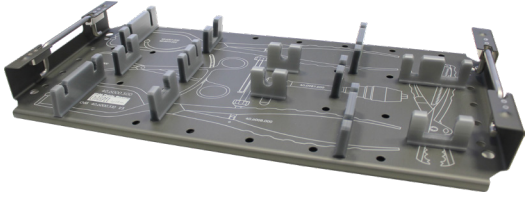







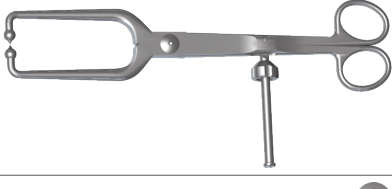

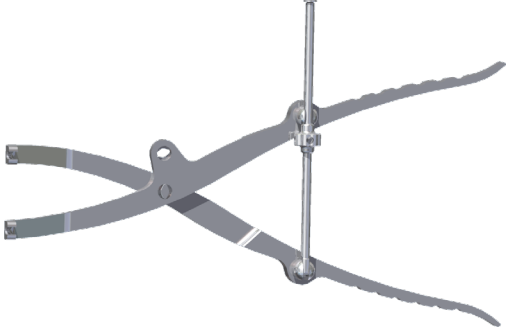
Przymiary płytek

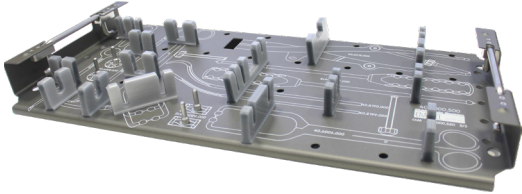











Lp.	Nr katalogowy	Nazwa
1	40.6019.000	Przymiar płytki 1.3035
2	40.6020.000	Przymiar płytki 1.3036
3	40.6021.000	Przymiar płytki 1.3117
4	40.6022.000	Przymiar płytki 1.3118
5	40.6023.000	Przymiar płytki 1.3119

III. INSTRUMENTARIUM



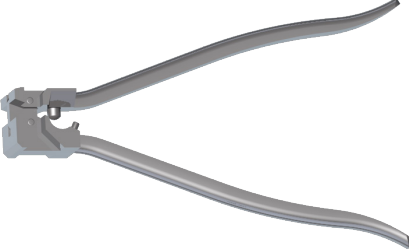

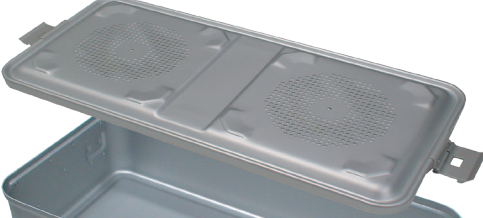

III.1. INSTRUMENTARIUM DO ZESPOLEŃ MIEDNICY 40.6000.500



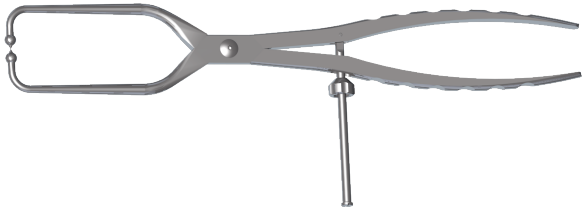
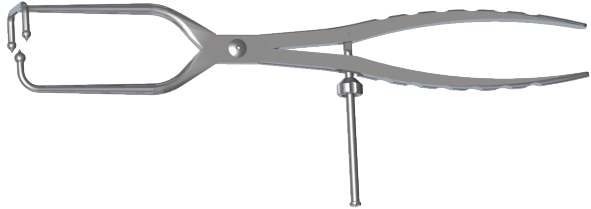
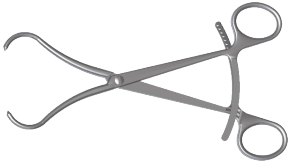

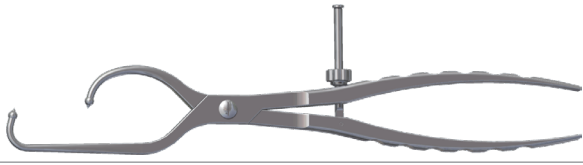
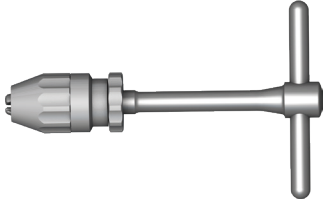
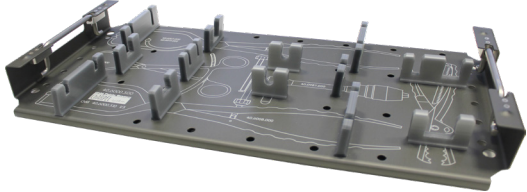







Lp.	Nazwa	Nr katalogowy	Szt.
1	 Szczypce redukcyjne długie 1x1	40.6007.000	1
2	 Szczypce redukcyjne długie 2x1	40.6008.000	1
3	 Szczypce redukcyjne zapadkowe z ostr. końcówkami	40.6009.000	1
4	 Szczypce kompresyjne	40.6016.000	1
5	 Szczypce redukcyjne asymetryczne	40.6017.000	1
6	 Rączka Steinmanna	40.0987.200	1
7	 Statyw na instrumentarium do zespoлей miednicy	40.6018.100	1
8	 Hak do kości prosty	40.6001.000	1
9	 Manipulator tymczasowy	40.6002.000	2
10	 Hak do kości z obsadą	40.6003.000	1

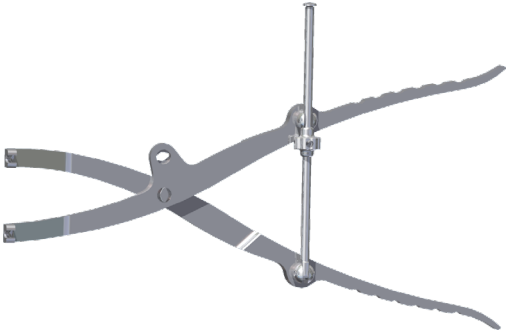

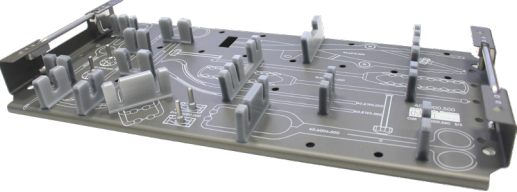



Lp.	Nazwa	Nr katalogowy	Szt.
11	 Szczypce kątowe redukcyjne odg. długie	40.6004.000	1
12	 Szczypce kątowe redukcyjne odg. krótkie	40.6005.000	1
13	 Szczypce kątowe redukcyjne proste	40.6006.000	1
14	 Zatrask wahlwy okrągły	40.6028.000	2
15	 Zatrask wahlwy prostokątny	40.6029.000	2
16	 Szczypce redukcyjne regulowane	40.6015.000	1
17	 Podważka 24	40.2199.001	1
18	 Podważka Lange Hohmann modyf. 30	40.2190.001	1
19	 Statyw na instrumentarium do zespołu miednicy	40.6018.150	1
20	Wiertło 2,5/250	40.2049.251	2
21	Wiertło 3,2/250	40.2053.251	2
22	 Wiertło 3,5/250	40.1363.251	2
23	Wiertło 4,5/250	40.1387.251	2
24	 Drut Kirschnera 2,0/220	40.4815.220	4
25	 Wiertło ze skalą 2,8/250	40.5653.251	2
26	 Grot kompresyjny 6x200	40.6035.200	2
27	 Wkręt ustalająco-dociskowy 2,8/180	40.5674.128	2
28	 Tuleja prowadząca 5,0/2,8	40.5673.028	4
29	 Rękojeść dynamometryczna ze sprzęgłem 2Nm	40.6652.000	1

Lp.		Nazwa	Nr katalogowy	Szt.
30		Grot T15	40.5677.150	1
31		Grot T25-3/16	40.5684.150	1
32		Prowadnica kompresyjna 2,5	40.4804.025	1
33		Chwytek wkrętów 4,5	40.6027.000	1
34		Chwytek wkrętów 3,5	40.6026.000	1
35		Gwintownik HA3,5	40.5926.000	1
36		Gwintownik HA4,5	40.5647.100	1
37		Wyginak do płytek rekonstrukcyjnych prosty	40.6013.000	2
38		Wyginak do pł. rekonstrukcyj. wielopłaszczyznowy	40.6014.000	1
39		Wzorec głębokości otworów L-150mm	40.2667.100	1
40		Statyw na instrumentarium do zespożeń miednicy	40.6018.200	1
41		Kontener z litym dnem 1/1 595x275x135mm	12.0750.102	2
42		Pokrywa aluminiowa perfor. 1/1 595x275x15mm Szara	12.0750.200	2





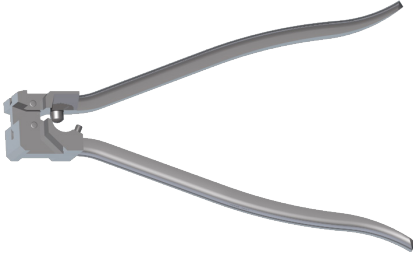

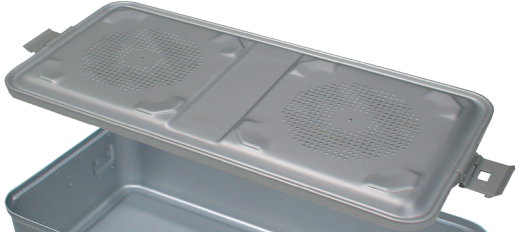
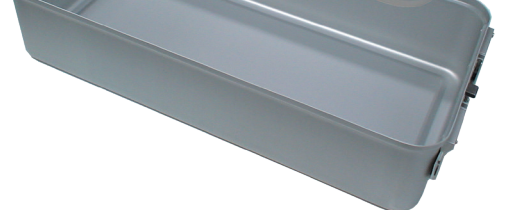
III.2. ZESTAW DO ZESPOLEŃ MIEDNICY 40.6000.600



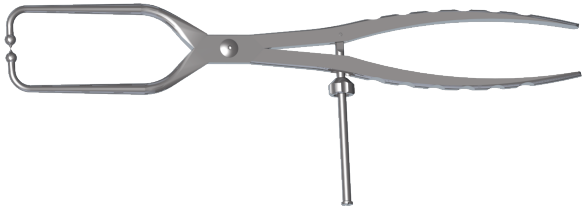
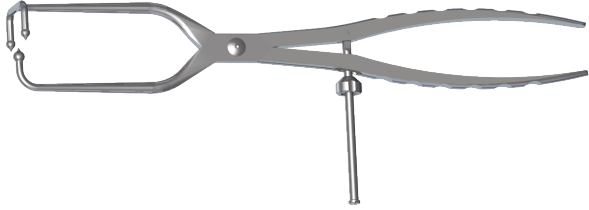
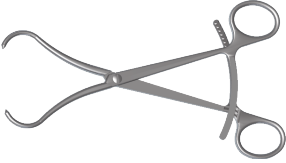

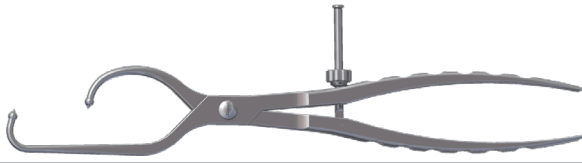
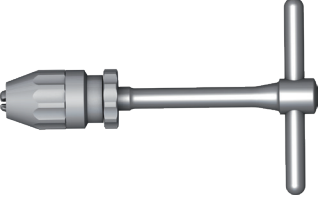
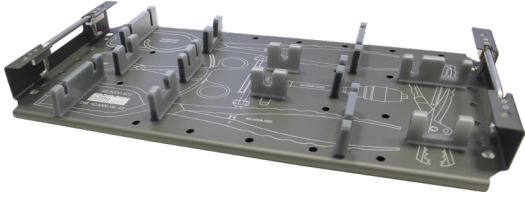

Lp.	Nazwa	Nr katalogowy	Szt.
1	 Szczypce redukcyjne długie 1x1	40.6007.000	1
2	 Szczypce redukcyjne długie 2x1	40.6008.000	1
3	 Szczypce redukcyjne zapadkowe z ostr. końcówkami	40.6009.000	1
4	 Szczypce kompresyjne	40.6016.000	1
5	 Szczypce redukcyjne asymetryczne	40.6017.000	1
6	 Rączka Steinmanna	40.0987.200	1
7	 Statyw na instrumentarium do zespożeń miednicy	40.6018.100	1
8	 Hak do kości prosty	40.6001.000	1
9	 Manipulator tymczasowy	40.6002.000	2
10	 Hak do kości z obsadą	40.6003.000	1
11	 Szczypce kątowe redukcyjne odg. długie	40.6004.000	1

Lp.	Nazwa	Nr katalogowy	Szt.
12	 Szczypce kątowe redukcyjne odg. krótkie	40.6005.000	1
13	 Szczypce kątowe redukcyjne proste	40.6006.000	1
14	 Zatrzask wahlivyy okrągły	40.6028.000	2
15	 Zatrzask wahlivyy prostokątny	40.6029.000	2
16	 Szczypce redukcyjne regulowane	40.6015.000	1
17	 Podważka 24	40.2199.001	1
18	 Podważka Lange Hohmann modyf. 30	40.2190.001	1
19	 Statyw na instrumentarium do zespołów medycyny	40.6018.150	1
20	Wiertło 2,5/250	40.2049.251	2
21	Wiertło 3,2/250	40.2053.251	2
22	 Wiertło 3,5/250	40.1363.251	2
23	Wiertło 4,5/250	40.1387.251	2
24	 Drut Kirschnera 2,0/220	40.4815.220	4
25	 Drut Kirschnera 2,0/220	40.6035.200	2
26	 Rękojeść dynamometryczna ze sprzęgłem 2Nm	40.6652.000	1
27	Grot T15	40.5677.150	1
28	Grot T25-3/16	40.5684.150	1
29	 Prowadnica kompresyjna 2,5	40.4804.025	1
30	Chwytek wkrętów 4,5	40.6027.000	1
31	Chwytek wkrętów 3,5	40.6026.000	1

Lp.		Nazwa	Nr katalogowy	Szt.
32		Gwintownik HA3,5	40.5926.000	1
33		Gwintownik HA4,5	40.5647.100	1
34		Wzorzec głębokości otworów L-150mm	40.2667.100	1
35		Wyginak do płytek rekonstrukcyjnych prosty	40.6013.000	2
36		Wyginak do pł. rekonstrukcyj. wielopłaszczyznowy	40.6014.000	1
37		Statyw na instrumentarium do zespołów medycy	40.6018.200	1
38		Kontener z litym dnem 1/1 595x275x135mm	12.0750.102	2
39		Pokrywa aluminiowa perfor.1/1 595x275x15mm Szara	12.0750.200	2

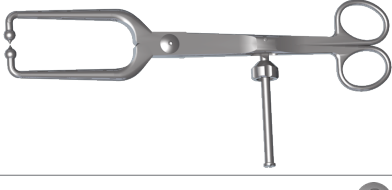
III.3. ZESTAW DO ZESPOLEŃ MIEDNICY - REPOZYCJA 40.6000.700

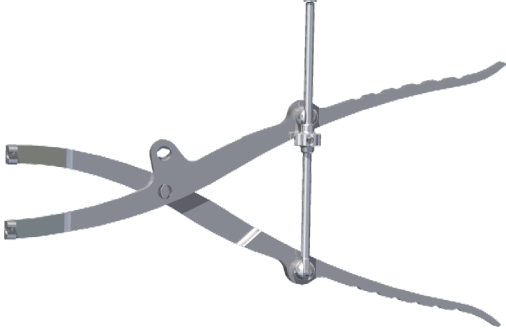
Lp.	Nazwa	Nr katalogowy	Szt.
1	 Szcypce redukcyjne długie 1x1	40.6007.000	1
2	 Szcypce redukcyjne długie 2x1	40.6008.000	1
3	 Szcypce redukcyjne zapadkowe z ostr. końcówkami	40.6009.000	1
4	 Szcypce kompresyjne	40.6016.000	1
5	 Szcypce redukcyjne asymetryczne	40.6017.000	1
6	 Rączka Steinmanna	40.0987.200	1
7	 Statyw na instrumentarium do zespożeń miednicy	40.6018.100	1
8	 Hak do kości prosty	40.6001.000	1
9	 Manipulator tymczasowy	40.6002.000	2
10	 Hak do kości z obsadą	40.6003.000	1

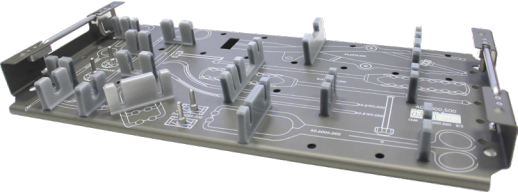
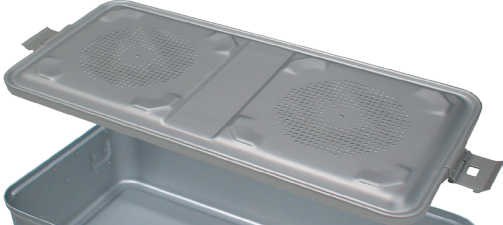
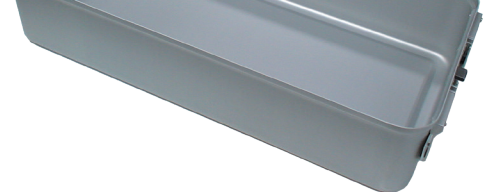
Lp.	Nazwa	Nr katalogowy	Szt.
11	 Szczypce kątowe redukcyjne odg. długie	40.6004.000	1
12	 Szczypce kątowe redukcyjne odg. krótkie	40.6005.000	1
13	 Szczypce kątowe redukcyjne proste	40.6006.000	1
14	 Zatrzask wahlowy okrągły	40.6028.000	2
15	 Zatrzask wahlowy prostokątny	40.6029.000	2
16	 Szczypce redukcyjne regulowane	40.6015.000	1
17	 Podważka 24	40.2199.001	1
18	 Podważka Lange Hohmann modyf. 30	40.2190.001	1
19	 Statyw na instrumentarium do zespołu miednicy	40.6018.150	1
20	 Kontener z litym dnem 1/1 595x275x135mm	12.0750.102	1
21	 Pokrywa aluminiowa perfor. 1/1 595x275x15mm Szara	12.0750.200	1