

# CHM<sup>®</sup>

CHARFIX<sup>system</sup>

## INTRAMEDULLARY OSTEOSYNTHESIS OF FEMUR

- *IMPLANTS*
- *INSTRUMENT SET 40.5090.600*
- *SURGICAL TECHNIQUE*

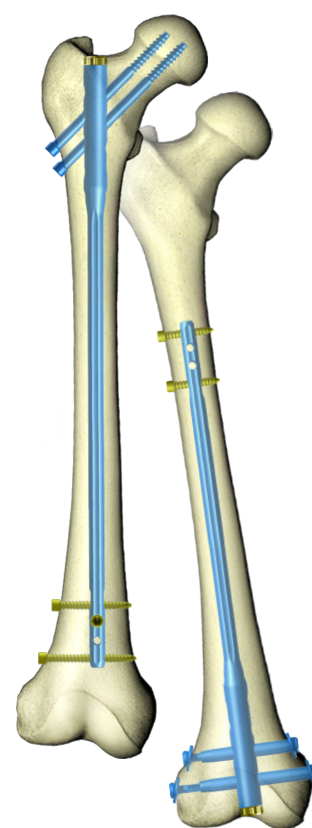

#### SYMBOLS DESCRIPTION

---



Caution - pay attention to a special procedure.

---



Perform the activity under X-Ray control.

---



Information about the next stages of a procedure.

---



Proceed to the next stage.

---



Return to the specified stage and repeat the activity.

---

**[www.chm.eu](http://www.chm.eu)**

Document No            ST/24F  
Date of issue            02.08.2010  
Review date            P-007-23.11.2020

*The manufacturer reserves the right to introduce design changes.  
Updated INSTRUCTIONS FOR USE are available at the following website: [ifu.chm.eu](http://ifu.chm.eu)*

<b>I. INTRODUCTION</b> .....	5
<b>I.1. RECONSTRUCTION, PERTROCHANTERIC METHOD</b> .....	5
<b>I.2. COMPRESSION, DYNAMIC AND STATIC METHOD</b> .....	6
<b>I.3. RETROGRADE METHOD (CONDYLAR APPROACH)</b> .....	7
<b>II. IMPLANTS</b> .....	8
<b>II.1. IMPLANTS FOR RECONSTRUCTION, COMPRESSION AND REVERSED METHOD</b> .....	8
<b>III. INSTRUMENT SET</b> .....	13
<b>III.1. INTRODUCTION</b> .....	13
<b>III.2. INSTRUMENT SET FOR RECONSTRUCTION, COMPRESSION AND RETROGRADE METHOD [40.5090.600]</b> .....	13
<b>IV. SURGICAL TECHNIQUE</b> .....	16
<b>IV.1. METHODS: RECONSTRUCTION, COMPRESSION, DYNAMIC, STATIC</b> .....	16
<i>IV.1.1. Introduction</i> .....	16
<i>IV.1.2. Preparation of medullary canal and nail insertion</i> .....	18
<b>IV.2. RECONSTRUCTION METHOD</b> .....	22
<i>IV.2.1. Proximal locking of the nail</i> .....	22
<i>IV.2.1.A. OPTION I: Locking with reconstruction screws</i> .....	22
<i>IV.2.1.B. OPTION II: Locking nail with reconstruction cannulated screws</i> .....	25
<i>IV.2.2. Distal locking of the nail</i> .....	27
<i>IV.2.3. Targeter removal, placing End cap</i> .....	33
<i>IV.2.4. Distal locking of the nail - "freehand technique"</i> .....	34
<b>IV.3. DYNAMIC AND COMPRESSION METHODS</b> .....	36
<i>IV.3.1. Distal locking of the nail</i> .....	36
<i>IV.3.2. Proximal locking of the nail</i> .....	37
<i>IV.3.3. Targeter removal</i> .....	39
<i>IV.3.4. Compression screw insertion</i> .....	39
<i>IV.3.5. End cap insertion (DYNAMIC method only)</i> .....	39
<b>IV.4. STATIC METHOD</b> .....	40
<i>IV.4.1. Distal nail locking</i> .....	40
<i>IV.4.2. Proximal nail locking</i> .....	40
<i>IV.4.3. Targeter removal, End cap insertion</i> .....	43
<b>IV.5. STATIC METHOD WITH THE USE OF RECONSTRUCTION NAIL</b> .....	44
<i>IV.5.1. Proximal nail locking</i> .....	44
<i>IV.5.2. Distal nail locking</i> .....	45
<i>IV.5.3. Targeter removal, End cap insertion</i> .....	46
<b>IV.6. NAIL REMOVAL</b> .....	46
<b>IV.7. SURGICAL APPROACH - RETROGRADE METHOD (CONDYLAR APPROACH)</b> .....	47
<i>IV.7.1. Implants for retrograde approach</i> .....	47
<i>IV.7.2. Introduction</i> .....	48
<i>IV.7.3. Nail assembling to the targeter, nail insertion into the medullary canal</i> .....	51
<i>IV.7.4. Locking the nail in the condylar femur</i> .....	53
<i>IV.7.4.A. OPTION I: Locking with screws</i> .....	53
<i>IV.7.4.B. OPTION II: Locking with locking set (bolt - two washers - locking screw)</i> .....	54
<i>IV.7.5. Locking the nail in the femoral shaft</i> .....	55
<i>IV.7.6. Targeter removal and End cap insertion</i> .....	60
<i>IV.7.7. Nail extraction</i> .....	60



## I. INTRODUCTION

**CHARFIX** system provides the following methods of intramedullary fixation:

- Reconstruction,
- Compression, dynamic, static,
- Retrograde (*condylar approach*).

Each fixation method of **CHARFIX** system comes with:

- adequate selection of implants (*intramedullary nails, screws, locking screws*),
- instrument sets for implants insertion and removal,
- instructions for use (*surgical technique*).

The presented range of implants is made of titanium and its alloys and implantable steel in accordance with ISO 5832 standard. Compliance with the requirements of Quality Management Systems and the requirements of Directive 93/42/EEC concerning medical devices guarantee high quality of the offered implants.

### I.1. RECONSTRUCTION, PERTROCHANTERIC METHOD

Reconstruction nails are used for intramedullary fixation of proximal femur neck or pertrochanteric fractures.

Angular position of reconstruction screws provides anatomical position of the head and trochanteric region against the femoral shaft. The nail comes in two versions: right nail for right femur, left nail for left femur.

Position of the implants in femur:

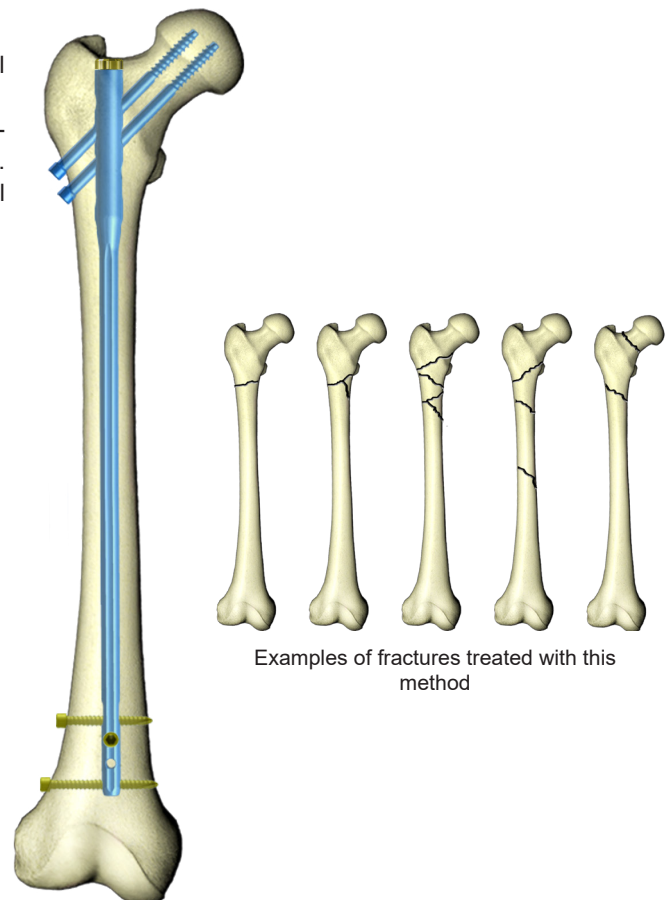

To fix the femoral fracture fragments with pertrochanteric method use:

- right nail for fixation of the left femur fractures
- left nail for fixation of the right femur fractures

Position of implants in femur:

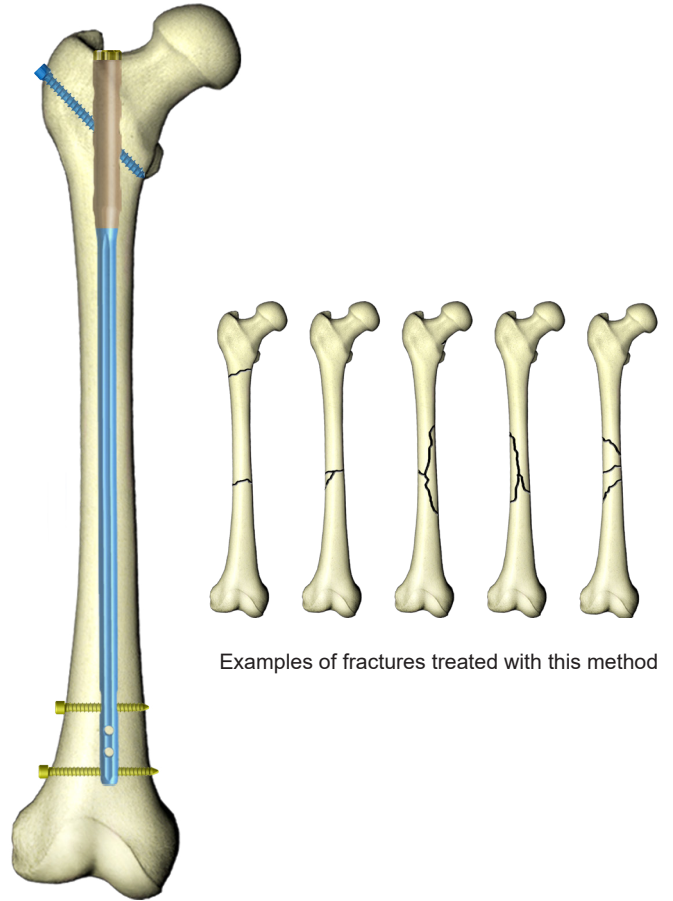

**I.2. COMPRESSION, DYNAMIC AND STATIC METHOD**

**Compressive lockings** are used in the intramedullary fixations of femoral shaft fractures, providing that fractures are not closer than 3cm from the locking screw. Nail design allows for treatment with the compression, dynamic and static method.

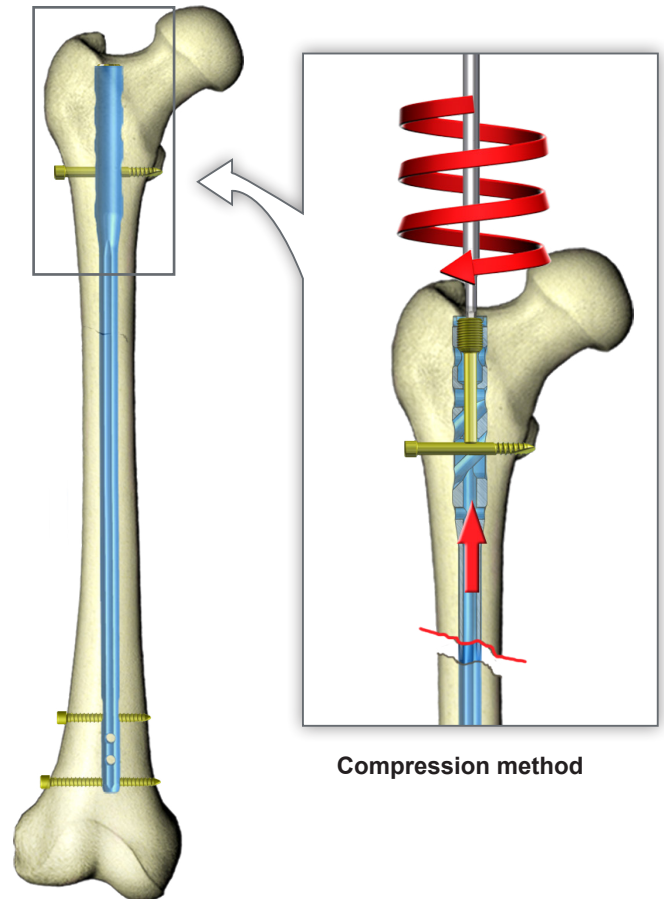

**Static locking**

Position of implants in femur:

**Static locking** (when needed, the proximal screw can be used to provide better locking of bone fragments).

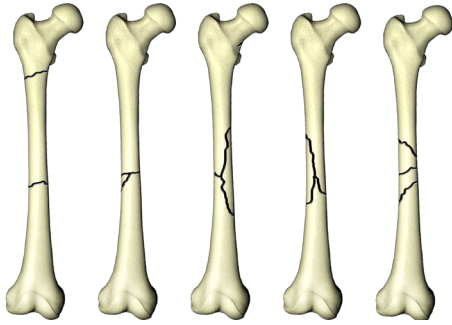

Examples of femoral shaft fractures treated with this method:

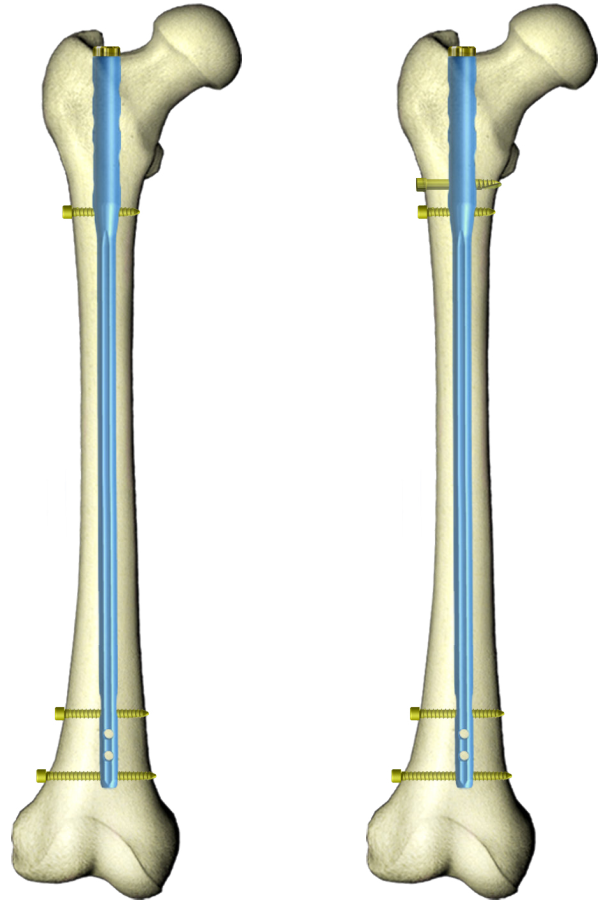
**I.3. RETROGRADE METHOD (CONDYLAR APPROACH)**

Intramedullary nails inserted within condylar approach enable fixation of the distal part of femur in the cases any other method (*reconstruction, compression, dynamic, static*) cannot be used. The reverse method can be used if prosthesis or another implant is located in the proximal femur or in the case condylar multifragmental fracture occurs.

Position of the implant in femur:

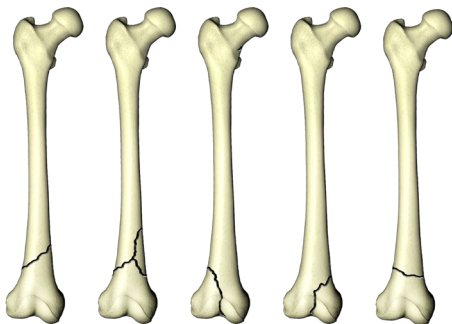

Examples of femoral shaft fractures treated with this method

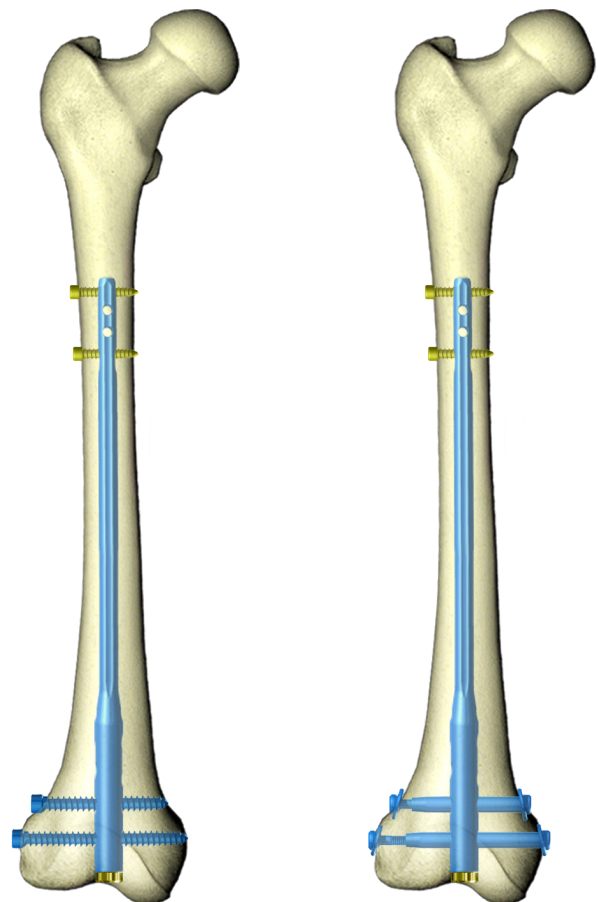

## II. IMPLANTS

### II.1. IMPLANTS FOR RECONSTRUCTION, COMPRESSION AND REVERSED METHOD

#### FEMORAL NAIL

**Reconstruction Method:**

- Steel: 1.1651.040-110, 3.1651.040-110
- Titanium: 1.2104.300-315, 3.2104.300-315
- Steel: 1.1652.060-120, 3.1652.060-120
- Steel: 1.1654.030-090, 3.1654.030-090
- Titanium: 1.2109.050-090, 3.2109.050-090

**Compression Method:**

- Steel: 1.2106.007, 3.2106.007
- Titanium: 1.2104.300-315, 3.2104.300-315
- Steel: 1.1654.030-090, 3.1654.030-090
- Titanium: 1.2109.050-090, 3.2109.050-090

**Retrograde Method:**

- Steel: 1.1654.030-090, 3.1654.030-090
- Titanium: 1.2104.300-315, 3.2104.300-315
- Steel: 1.1651.040-110, 3.1651.040-110
- Titanium: 1.2104.002, 3.2104.002



**Locking Screws:**

- Steel: 1.1654.030-090, 3.1654.030-090
- Titanium: 1.2109.050-090, 3.2109.050-090
- Steel: 1.1651.040-110, 3.1651.040-110
- Titanium: 1.2104.002, 3.2104.002

**Labels:** cannulated, solid, left, right, reconstruction method, compression method, retrograde method.



## FEMORAL NAIL

											
		Steel		Titanium				Steel		Titanium	
L [mm]	Ø	left	right	left	right	L [mm]	Ø	left	right	left	right
200	9	1.2855.200	1.2854.200	3.2855.200	3.2854.200	200	12	1.2861.200	1.2860.200	3.2861.200	3.2860.200
220		1.2855.220	1.2854.220	3.2855.220	3.2854.220	220		1.2861.220	1.2860.220	3.2861.220	3.2860.220
240		1.2855.240	1.2854.240	3.2855.240	3.2854.240	240		1.2861.240	1.2860.240	3.2861.240	3.2860.240
260		1.2855.260	1.2854.260	3.2855.260	3.2854.260	260		1.2861.260	1.2860.260	3.2861.260	3.2860.260
280		1.2855.280	1.2854.280	3.2855.280	3.2854.280	280		1.2861.280	1.2860.280	3.2861.280	3.2860.280
300		1.2855.300	1.2854.300	3.2855.300	3.2854.300	300		1.2861.300	1.2860.300	3.2861.300	3.2860.300
320		1.2855.320	1.2854.320	3.2855.320	3.2854.320	320		1.2861.320	1.2860.320	3.2861.320	3.2860.320
340		1.2855.340	1.2854.340	3.2855.340	3.2854.340	340		1.2861.340	1.2860.340	3.2861.340	3.2860.340
360		1.2855.360	1.2854.360	3.2855.360	3.2854.360	360		1.2861.360	1.2860.360	3.2861.360	3.2860.360
380		1.2855.380	1.2854.380	3.2855.380	3.2854.380	380		1.2861.380	1.2860.380	3.2861.380	3.2860.380
400		1.2855.400	1.2854.400	3.2855.400	3.2854.400	400		1.2861.400	1.2860.400	3.2861.400	3.2860.400
420		1.2855.420	1.2854.420	3.2855.420	3.2854.420	420		1.2861.420	1.2860.420	3.2861.420	3.2860.420
440		1.2855.440	1.2854.440	3.2855.440	3.2854.440	440		1.2861.440	1.2860.440	3.2861.440	3.2860.440
460		1.2855.460	1.2854.460	3.2855.460	3.2854.460	460		1.2861.460	1.2860.460	3.2861.460	3.2860.460
480		1.2855.480	1.2854.480	3.2855.480	3.2854.480	480		1.2861.480	1.2860.480	3.2861.480	3.2860.480
200		10	1.2857.200	1.2856.200	3.2857.200	3.2856.200		200	13	1.2863.200	1.2862.200
220	1.2857.220		1.2856.220	3.2857.220	3.2856.220	220	1.2863.220	1.2862.220		3.2863.220	3.2862.220
240	1.2857.240		1.2856.240	3.2857.240	3.2856.240	240	1.2863.240	1.2862.240		3.2863.240	3.2862.240
260	1.2857.260		1.2856.260	3.2857.260	3.2856.260	260	1.2863.260	1.2862.260		3.2863.260	3.2862.260
280	1.2857.280		1.2856.280	3.2857.280	3.2856.280	280	1.2863.280	1.2862.280		3.2863.280	3.2862.280
300	1.2857.300		1.2856.300	3.2857.300	3.2856.300	300	1.2863.300	1.2862.300		3.2863.300	3.2862.300
320	1.2857.320		1.2856.320	3.2857.320	3.2856.320	320	1.2863.320	1.2862.320		3.2863.320	3.2862.320
340	1.2857.340		1.2856.340	3.2857.340	3.2856.340	340	1.2863.340	1.2862.340		3.2863.340	3.2862.340
360	1.2857.360		1.2856.360	3.2857.360	3.2856.360	360	1.2863.360	1.2862.360		3.2863.360	3.2862.360
380	1.2857.380		1.2856.380	3.2857.380	3.2856.380	380	1.2863.380	1.2862.380		3.2863.380	3.2862.380
400	1.2857.400		1.2856.400	3.2857.400	3.2856.400	400	1.2863.400	1.2862.400		3.2863.400	3.2862.400
420	1.2857.420		1.2856.420	3.2857.420	3.2856.420	420	1.2863.420	1.2862.420		3.2863.420	3.2862.420
440	1.2857.440		1.2856.440	3.2857.440	3.2856.440	440	1.2863.440	1.2862.440		3.2863.440	3.2862.440
460	1.2857.460		1.2856.460	3.2857.460	3.2856.460	460	1.2863.460	1.2862.460		3.2863.460	3.2862.460
480	1.2857.480		1.2856.480	3.2857.480	3.2856.480	480	1.2863.480	1.2862.480		3.2863.480	3.2862.480
200	11		1.2859.200	1.2858.200	3.2859.200	3.2858.200	200	14		1.2865.200	1.2864.200
220		1.2859.220	1.2858.220	3.2859.220	3.2858.220	220	1.2865.220		1.2864.220	3.2865.220	3.2864.220
240		1.2859.240	1.2858.240	3.2859.240	3.2858.240	240	1.2865.240		1.2864.240	3.2865.240	3.2864.240
260		1.2859.260	1.2858.260	3.2859.260	3.2858.260	260	1.2865.260		1.2864.260	3.2865.260	3.2864.260
280		1.2859.280	1.2858.280	3.2859.280	3.2858.280	280	1.2865.280		1.2864.280	3.2865.280	3.2864.280
300		1.2859.300	1.2858.300	3.2859.300	3.2858.300	300	1.2865.300		1.2864.300	3.2865.300	3.2864.300
320		1.2859.320	1.2858.320	3.2859.320	3.2858.320	320	1.2865.320		1.2864.320	3.2865.320	3.2864.320
340		1.2859.340	1.2858.340	3.2859.340	3.2858.340	340	1.2865.340		1.2864.340	3.2865.340	3.2864.340
360		1.2859.360	1.2858.360	3.2859.360	3.2858.360	360	1.2865.360		1.2864.360	3.2865.360	3.2864.360
380		1.2859.380	1.2858.380	3.2859.380	3.2858.380	380	1.2865.380		1.2864.380	3.2865.380	3.2864.380
400		1.2859.400	1.2858.400	3.2859.400	3.2858.400	400	1.2865.400		1.2864.400	3.2865.400	3.2864.400
420		1.2859.420	1.2858.420	3.2859.420	3.2858.420	420	1.2865.420		1.2864.420	3.2865.420	3.2864.420
440		1.2859.440	1.2858.440	3.2859.440	3.2858.440	440	1.2865.440		1.2864.440	3.2865.440	3.2864.440
460		1.2859.460	1.2858.460	3.2859.460	3.2858.460	460	1.2865.460		1.2864.460	3.2865.460	3.2864.460
480		1.2859.480	1.2858.480	3.2859.480	3.2858.480	480	1.2865.480		1.2864.480	3.2865.480	3.2864.480

FEMORAL NAIL

L [mm]	Ø	Steel		Titanium		L [mm]	Ø	Steel		Titanium	
		left	right	left	right			left	right	left	right
200	8	1.2877.200	1.2876.200	3.2877.200	3.2876.200	200	11	1.2883.200	1.2882.200	3.2883.200	3.2882.200
220		1.2877.220	1.2876.220	3.2877.220	3.2876.220	220		1.2883.220	1.2882.220	3.2883.220	3.2882.220
240		1.2877.240	1.2876.240	3.2877.240	3.2876.240	240		1.2883.240	1.2882.240	3.2883.240	3.2882.240
260		1.2877.260	1.2876.260	3.2877.260	3.2876.260	260		1.2883.260	1.2882.260	3.2883.260	3.2882.260
280		1.2877.280	1.2876.280	3.2877.280	3.2876.280	280		1.2883.280	1.2882.280	3.2883.280	3.2882.280
300		1.2877.300	1.2876.300	3.2877.300	3.2876.300	300		1.2883.300	1.2882.300	3.2883.300	3.2882.300
320		1.2877.320	1.2876.320	3.2877.320	3.2876.320	320		1.2883.320	1.2882.320	3.2883.320	3.2882.320
340		1.2877.340	1.2876.340	3.2877.340	3.2876.340	340		1.2883.340	1.2882.340	3.2883.340	3.2882.340
360		1.2877.360	1.2876.360	3.2877.360	3.2876.360	360		1.2883.360	1.2882.360	3.2883.360	3.2882.360
380		1.2877.380	1.2876.380	3.2877.380	3.2876.380	380		1.2883.380	1.2882.380	3.2883.380	3.2882.380
400		1.2877.400	1.2876.400	3.2877.400	3.2876.400	400		1.2883.400	1.2882.400	3.2883.400	3.2882.400
420		1.2877.420	1.2876.420	3.2877.420	3.2876.420	420		1.2883.420	1.2882.420	3.2883.420	3.2882.420
440		1.2877.440	1.2876.440	3.2877.440	3.2876.440	440		1.2883.440	1.2882.440	3.2883.440	3.2882.440
460		1.2877.460	1.2876.460	3.2877.460	3.2876.460	460		1.2883.460	1.2882.460	3.2883.460	3.2882.460
480		1.2877.480	1.2876.480	3.2877.480	3.2876.480	480		1.2883.480	1.2882.480	3.2883.480	3.2882.480
200		9	1.2879.200	1.2878.200	3.2879.200	3.2878.200		200	12	1.2885.200	1.2884.200
220	1.2879.220		1.2878.220	3.2879.220	3.2878.220	220	1.2885.220	1.2884.220		3.2885.220	3.2884.220
240	1.2879.240		1.2878.240	3.2879.240	3.2878.240	240	1.2885.240	1.2884.240		3.2885.240	3.2884.240
260	1.2879.260		1.2878.260	3.2879.260	3.2878.260	260	1.2885.260	1.2884.260		3.2885.260	3.2884.260
280	1.2879.280		1.2878.280	3.2879.280	3.2878.280	280	1.2885.280	1.2884.280		3.2885.280	3.2884.280
300	1.2879.300		1.2878.300	3.2879.300	3.2878.300	300	1.2885.300	1.2884.300		3.2885.300	3.2884.300
320	1.2879.320		1.2878.320	3.2879.320	3.2878.320	320	1.2885.320	1.2884.320		3.2885.320	3.2884.320
340	1.2879.340		1.2878.340	3.2879.340	3.2878.340	340	1.2885.340	1.2884.340		3.2885.340	3.2884.340
360	1.2879.360		1.2878.360	3.2879.360	3.2878.360	360	1.2885.360	1.2884.360		3.2885.360	3.2884.360
380	1.2879.380		1.2878.380	3.2879.380	3.2878.380	380	1.2885.380	1.2884.380		3.2885.380	3.2884.380
400	1.2879.400		1.2878.400	3.2879.400	3.2878.400	400	1.2885.400	1.2884.400		3.2885.400	3.2884.400
420	1.2879.420		1.2878.420	3.2879.420	3.2878.420	420	1.2885.420	1.2884.420		3.2885.420	3.2884.420
440	1.2879.440		1.2878.440	3.2879.440	3.2878.440	440	1.2885.440	1.2884.440		3.2885.440	3.2884.440
460	1.2879.460		1.2878.460	3.2879.460	3.2878.460	460	1.2885.460	1.2884.460		3.2885.460	3.2884.460
480	1.2879.480		1.2878.480	3.2879.480	3.2878.480	480	1.2885.480	1.2884.480		3.2885.480	3.2884.480
200	10		1.2881.200	1.2880.200	3.2881.200	3.2880.200	200	13		1.2887.200	1.2886.200
220		1.2881.220	1.2880.220	3.2881.220	3.2880.220	220	1.2887.220		1.2886.220	3.2887.220	3.2886.220
240		1.2881.240	1.2880.240	3.2881.240	3.2880.240	240	1.2887.240		1.2886.240	3.2887.240	3.2886.240
260		1.2881.260	1.2880.260	3.2881.260	3.2880.260	260	1.2887.260		1.2886.260	3.2887.260	3.2886.260
280		1.2881.280	1.2880.280	3.2881.280	3.2880.280	280	1.2887.280		1.2886.280	3.2887.280	3.2886.280
300		1.2881.300	1.2880.300	3.2881.300	3.2880.300	300	1.2887.300		1.2886.300	3.2887.300	3.2886.300
320		1.2881.320	1.2880.320	3.2881.320	3.2880.320	320	1.2887.320		1.2886.320	3.2887.320	3.2886.320
340		1.2881.340	1.2880.340	3.2881.340	3.2880.340	340	1.2887.340		1.2886.340	3.2887.340	3.2886.340
360		1.2881.360	1.2880.360	3.2881.360	3.2880.360	360	1.2887.360		1.2886.360	3.2887.360	3.2886.360
380		1.2881.380	1.2880.380	3.2881.380	3.2880.380	380	1.2887.380		1.2886.380	3.2887.380	3.2886.380
400		1.2881.400	1.2880.400	3.2881.400	3.2880.400	400	1.2887.400		1.2886.400	3.2887.400	3.2886.400
420		1.2881.420	1.2880.420	3.2881.420	3.2880.420	420	1.2887.420		1.2886.420	3.2887.420	3.2886.420
440		1.2881.440	1.2880.440	3.2881.440	3.2880.440	440	1.2887.440		1.2886.440	3.2887.440	3.2886.440
460		1.2881.460	1.2880.460	3.2881.460	3.2880.460	460	1.2887.460		1.2886.460	3.2887.460	3.2886.460
480		1.2881.480	1.2880.480	3.2881.480	3.2880.480	480	1.2887.480		1.2886.480	3.2887.480	3.2886.480

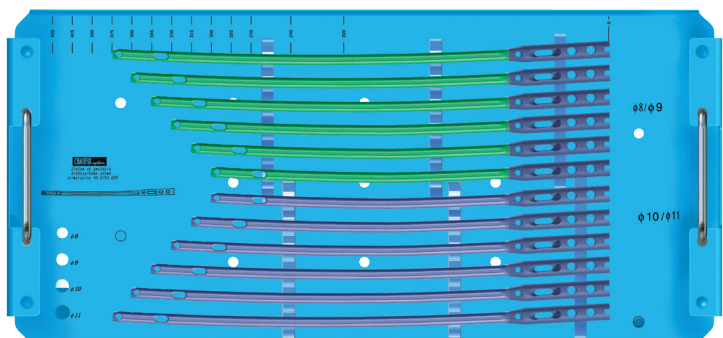

40.5753.000  
Stand for universal femoral nails (implants not included)

available			
Ø [mm] pitch 1 mm	8+15	8+10	11+15
L [mm] pitch 5 mm	160+600	160+600	160+600

Titanium	Ø8	Ø9	Ø10	Ø11	Ø12	Ø13
left						
right						
colours						

LOCKING ELEMENTS



End cap M10x1

Catalogue no.		
A	Steel	Titanium
0	1.2104.300	3.2104.300
+5	1.2104.305	3.2104.305
+10	1.2104.310	3.2104.310
+15	1.2104.315	3.2104.315



End cap M10x1

Catalogue no.		
A	Steel	Titanium
2	1.2104.002	3.2104.002



Compression screw

Catalogue no.	
Steel	Titanium
1.2106.007	3.2106.007

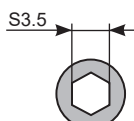

Distal screw Ø4.5

Catalogue no.		
L [mm]	Steel	Titanium
30	1.1654.030	3.1654.030
35	1.1654.035	3.1654.035
40	1.1654.040	3.1654.040
45	1.1654.045	3.1654.045
50	1.1654.050	3.1654.050
55	1.1654.055	3.1654.055
60	1.1654.060	3.1654.060
65	1.1654.065	3.1654.065
70	1.1654.070	3.1654.070
75	1.1654.075	3.1654.075
80	1.1654.080	3.1654.080
85	1.1654.085	3.1654.085
90	1.1654.090	3.1654.090

available

L [mm]	16 ÷ 100
--------	----------

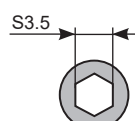

Proximal screw Ø4.5

Catalogue no.			
L [mm]	L <sub>1</sub> [mm]	Steel	Titanium
30	12	1.1653.030	3.1653.030
35	16	1.1653.035	3.1653.035
40	16	1.1653.040	3.1653.040
45	16	1.1653.045	3.1653.045
50	18	1.1653.050	3.1653.050
55	18	1.1653.055	3.1653.055
60	18	1.1653.060	3.1653.060
65	20	1.1653.065	3.1653.065
70	20	1.1653.070	3.1653.070
75	20	1.1653.075	3.1653.075
80	22	1.1653.080	3.1653.080
85	22	1.1653.085	3.1653.085
90	22	1.1653.090	3.1653.090

available

L [mm]	25 ÷ 90
--------	---------

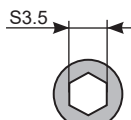

Distal screw Ø6.5

Catalogue no.		
L [mm]	Steel	Titanium
40	1.1651.040	3.1651.040
45	1.1651.045	3.1651.045
50	1.1651.050	3.1651.050
55	1.1651.055	3.1651.055
60	1.1651.060	3.1651.060
65	1.1651.065	3.1651.065
70	1.1651.070	3.1651.070
75	1.1651.075	3.1651.075
80	1.1651.080	3.1651.080
85	1.1651.085	3.1651.085
90	1.1651.090	3.1651.090
95	1.1651.095	3.1651.095
100	1.1651.100	3.1651.100
105	1.1651.105	3.1651.105
110	1.1651.110	3.1651.110

available

L [mm]	30 ÷ 110
--------	----------

Locking set Ø6.5



Catalogue no.			
L [mm]	Range	Steel	Titanium
50	50-65 [mm]	1.2109.050	3.2109.050
60	60-75 [mm]	1.2109.060	3.2109.060
70	70-85 [mm]	1.2109.070	3.2109.070
80	80-95 [mm]	1.2109.080	3.2109.080
90	90-105 [mm]	1.2109.090	3.2109.090

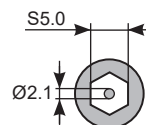

Reconstruction cannulated screw Ø6.5

Catalogue no.			
L [mm]	L <sub>1</sub> [mm]	Steel	Titanium
60	25	1.1652.060	3.1652.060
65	25	1.1652.065	3.1652.065
70	25	1.1652.070	3.1652.070
75	25	1.1652.075	3.1652.075
80	25	1.1652.080	3.1652.080
85	25	1.1652.085	3.1652.085
90	25	1.1652.090	3.1652.090
95	32	1.1652.095	3.1652.095
100	32	1.1652.100	3.1652.100
105	32	1.1652.105	3.1652.105
110	32	1.1652.110	3.1652.110
115	32	1.1652.115	3.1652.115
120	32	1.1652.120	3.1652.120

LOCKING ELEMENTS

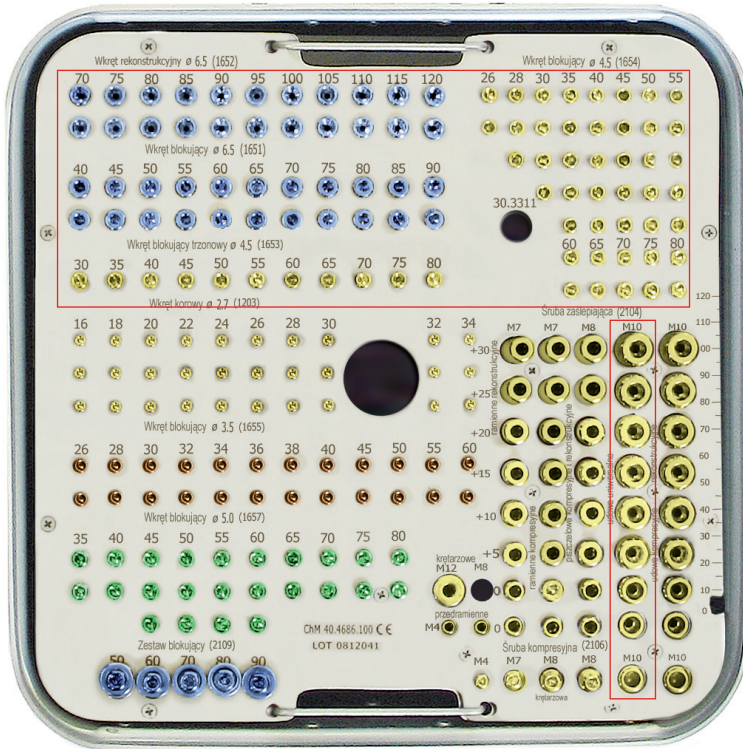

**40.4686.000**  
Stand for nail locking elements (set with a box without implants)











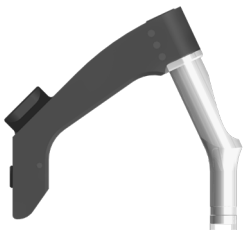

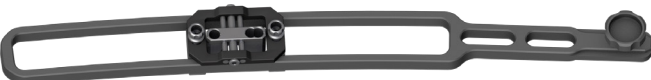



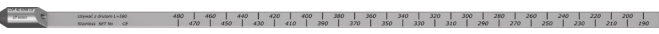



### III. INSTRUMENT SET













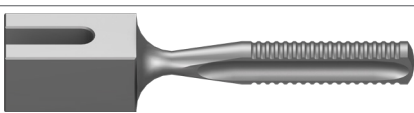







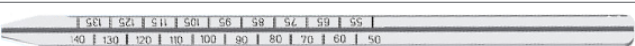

#### III.1. INTRODUCTION

Fixation of the femoral fractures with reconstruction, compression, dynamic or static method is carried out with a single instrument set. When using the above mentioned methods, it is also required to have at your disposal a set of flexible intramedullary reamers in the following diameters: 8 [40.3854], 8.5 [40.3855], 9 [40.3856], 9.5 [40.3857], 10 [40.3858], 10.5 [40.3859], 11 [40.3860], 11.5 [40.3861], 12 [40.3862], 12.5 [40.3863], 13 [40.3864], 13.5 [40.3865], 14 [40.3866], 14.5 [40.3867], 15 [40.3868] and surgical drive or handle for a manual reaming. The operation is to be performed on operating table equipped with the X-Ray image intensifier.

#### III.2. INSTRUMENT SET FOR RECONSTRUCTION, COMPRESSION AND RETROGRADE METHOD [40.5090.600]

All instruments are placed on a stand with a lid to enable sterilization and transportation to the operating suite.

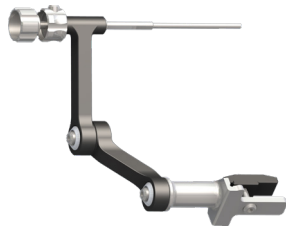
No.		Name	Catalogue No.	Pcs
1		Targeter arm	40.5091.000	1
2		Targeter 135	40.5097.000	1
3		Distal targeter D	40.5093.000	1
4		Connecting screw M10x1 L=55	40.5094.000	1
5		Connecting screw M10x1 L=66	40.5095.000	1
6		Compression screw	40.5096.000	1
7		Nail length measure	40.5098.000	1
8		Trocar 9	40.3327.000	1
9		Protective guide 11/9	40.3328.000	2
10		Drill guide 9/6.5	40.3329.000	1
11		Drill guide 9/4.5	40.3330.000	1
12		Kirschner guide	40.3331.000	1
13		Reconstruction screw length measure	40.3332.000	1
14		Kirschner wire 2.0/380	40.3333.000	4
15		Protective guide 9/6.5	40.3614.000	3
16		Drill guide 6.5/3.5	40.3615.000	3
17		Set block 9/4.5	40.3616.000	2
18		Trocar 6.5	40.3617.000	1
19		Drill guide 6.5/4.5	40.3696.000	1
20		Screw length measure	40.1374.000	1

No.		Name	Catalogue No.	Pcs
21		Curved awl 8.0	40.5523.000	1
22		Impactor-extractor	40.5507.000	1
23		Mallet	40.3667.000	1
24		Соединитель M10x1/M12	40.5071.000	1
25		Wrench S10	40.5526.100	1
26		Teflon pipe guide	40.1348.000	1
27		Guide rod 3.0/580	40.3925.580	1
28		Guide rod handle	40.1351.000	1
29		Screwdriver S 3.5	40.3604.000	1
30		Drill with scale 4.5/370	40.5333.001	1
31		Drill with scale 3.5/270	40.5330.001	3
32		Drill 6.5/370	40.2068.371	1
33		Cannulated drill 6.5/300	40.3674.000	1
34		Cannulated screwdriver S 5.0/2.2	40.3675.000	1
35		Cannulated screw length measure	40.3676.000	1
36		Aiming insert 9.0	40.5065.009	2
37		Aiming insert 11.0	40.5065.011	2
38		Screwdriver S3,5	40.5074.000	1
39		Bolt guide	40.5075.000	1
40		Drill 4.5/270	40.1387.001	1
41		Angular set block	40.5004.500	1
42		Protective guide 11/9	40.3662.000	1

No.		Name	Catalogue No.	Pcs
43		Stand	40.5099.600	1

## IV. SURGICAL TECHNIQUE

### IV.1. METHODS: RECONSTRUCTION, COMPRESSION, DYNAMIC, STATIC

#### IV.1.1. Introduction

Tightly fitting the medullary canal is not necessary if the locking nail is used. In the case of placing the nail without reaming the canal, the following diameters 8, 9, 10, 11 mm of the nail should be used. Nails with diameter 12, 13, 14 are used for the cases where reaming has to be done.

Please note that the diameter of reamed canal has to be about 2mm wider than the diameter of the nail.

In every case, hole is to be made in proximal part of femur, 13 mm in diameter for the nails sizes 8, 9, 10, 11, 12, 13 mm or 14 mm in diameter for the nail 14 mm, and to 8 cm in depth.

It enables the insertion of proximal part, where the nail is made thicker. Decision about possible reaming after verifying the shape of canal and type of fracture shall be made by a surgeon.

Reaming of medullary canal is not recommended for patients with chest injuries due to the risk of fat embolism.

When patient cannot be operated at the day of femoral fracture, it is recommended to apply strong traction for 2 to 3 days to spread the fragments. This considerably enables fracture reduction and nail insertion.

Placing the patient on a table with traction is an integral part of the surgery.

Presented method of intramedullary osteosynthesis requires intraoperative radiological examination.

Each surgical procedure must be carefully planned. X-Ray of the entire femur is essential as to make sure no injuries in its proximal or distal part are overlooked.

It is especially important in the cases of nailing the pathological subtrochanteric fractures. Special attention is to be paid to concurrent femoral neck fractures or proximal epiphysis multi-fragmental fractures, and to the possibility of their occurrence during the procedure of nail insertion. During the operation, secondary fractures of main fragments may occur.

In such cases the dynamic stabilization has to be replaced by a static one.

The condition of the hip joint is also very important. In advanced arthrosis or contracture, nail fixation may be difficult or even impossible to perform.

In addition, it should be verified whether alloplasty of hip or knee has ever been performed on the fractured bone before. The procedure has to be carried out on the operating table with traction with the patient placed supine or on the side. The side position enables the approach to the greater trochanter, which is especially important with overweight patients.

The supine position provides less favorable access to the greater trochanter, but makes all other stages of the operation considerably easier (*especially rotary corrections*).



In the presented method, the supine position is recommended with traction applied to the condyles of the operated femur.

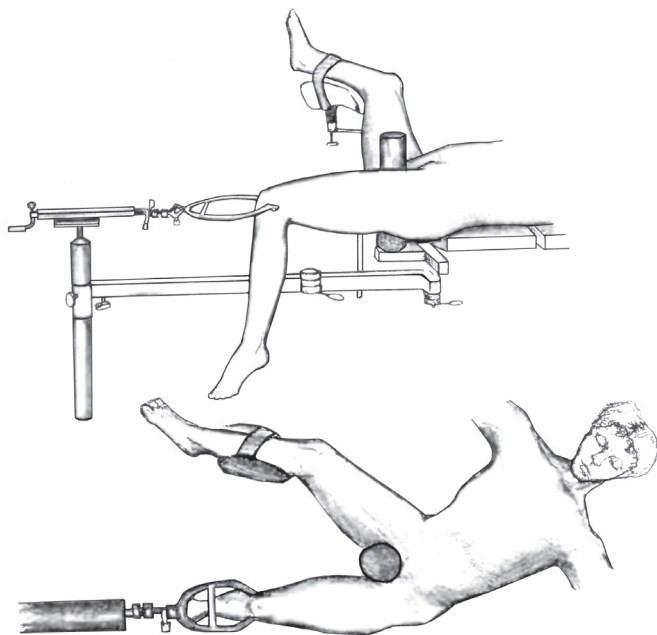
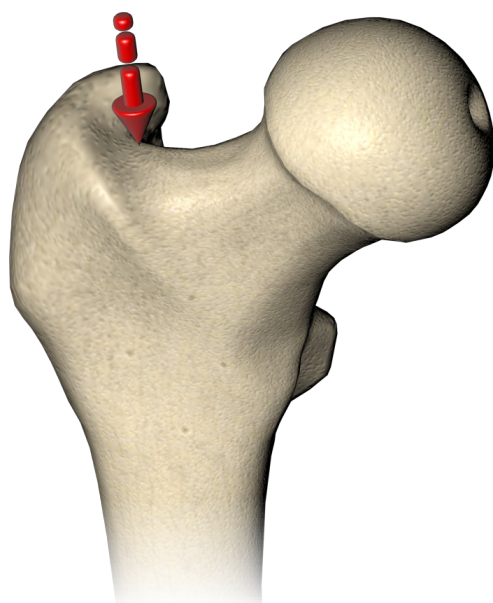

FIG. 1. Supine position for intramedullary osteosynthesis of femur.

Lateral surgical approach shall be applied. Begin the incision near the tip of greater trochanter in line with the femoral shaft axis for 8cm. The incision should be longer for overweight patients. The fascia should be cut in the same direction as the incision. Fibers of greater gluteal muscle are then split, as to provide an access to the tip of greater trochanter. The entry point for the nail should be located in line with the axis of medullary canal. It can be found in practice in the following way.

If one finds the tip of greater trochanter with his index finger, the entry point is *“a little bit medially”* (in the direction to the base of the femoral neck) and *“slightly anteriorly”*, in a place where one should feel small dale (*fossa piriformis*) with his index finger (see Fig. 2).

FIG. 2 Entry point for femoral nail.





**ATTENTION!** The following paragraphs describe the most important steps during insertion of intramedullary interlocking femoral nails; nevertheless, it is not a detailed instructions for use. The surgeon decides about choosing the surgical technique and its application in each individual case.

The physician uses images of both fractured and healthy femur to determine the length, diameter and type of the nail.

**IV.1.2. Preparation of medullary canal and nail insertion.**

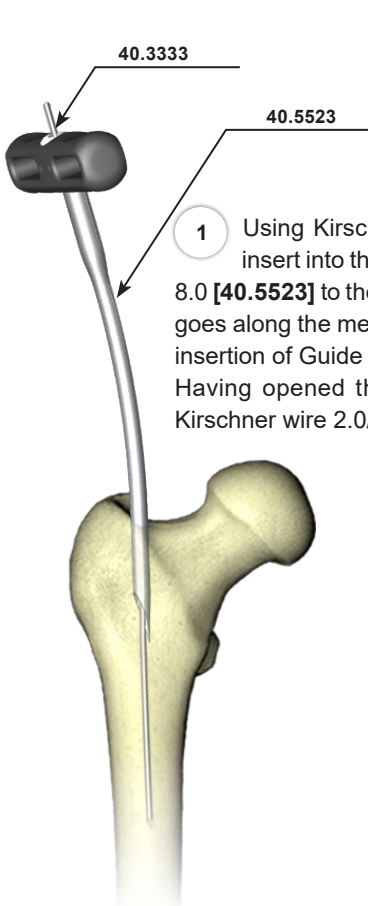

**1** Using Kirschner wire 2.0/380 [40.3333], insert into the medullary canal Curved awl 8.0 [40.5523] to the depth at which the Awl blade goes along the medullary canal, allowing proper insertion of Guide rod 3.0/580 [40.3925.580]. Having opened the medullary canal, remove Kirschner wire 2.0/380 [40.3333].

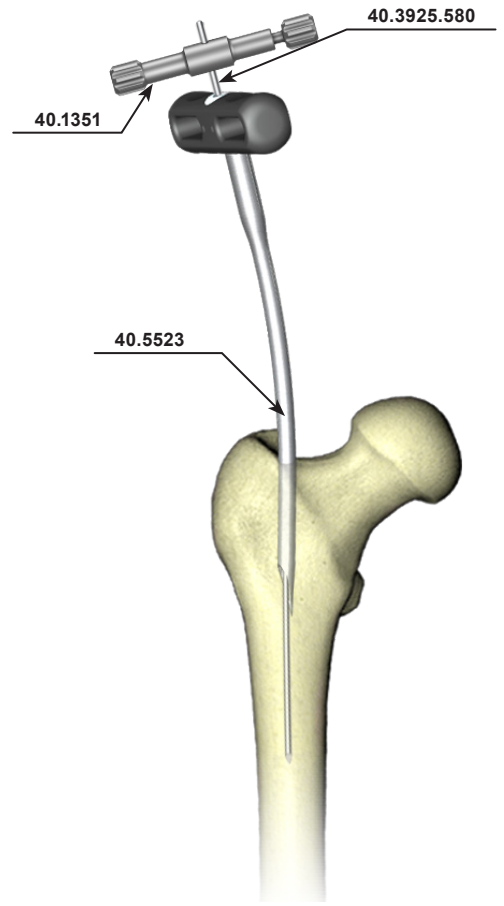

**2** Mount Guide rod 3.0/580 [40.3925.580] to Guide rod handle [40.1351] and enter the guide into the medullary canal through Curved awl 8.0 [40.5523] cannulated hole to the depth required for the proper fixation of bone fragments. While guide rod insertion, control the fracture reduction and make sure the guide rod passes through all the bone fragments. Remove Guide rod handle [40.1351] and Curved awl 8.0 [40.5523]. Leave Guide rod 3.0/580 [40.3925.580] in place.

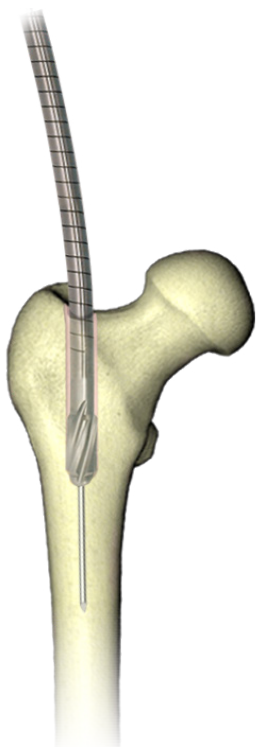

**3** In the case medullary canal is reamed, gradually increase the diameter with steps of 0.5 mm, until the diameter 1.5 to 2.0 mm wider than the diameter of the femoral nail is reached, for the depth at least equal to the nail length (*but not lesser*). In both cases when the medullary canal was reamed or not, the canal should be reamed using 13 or 14 mm reamer to the depth of approx. 8 cm.

Remove the flexible reamer.



**NOTE!** Steps [4] and [5] are applicable only if the medullary canal has been reamed or if another reamer guide has been used. Otherwise proceed directly with the step [6].

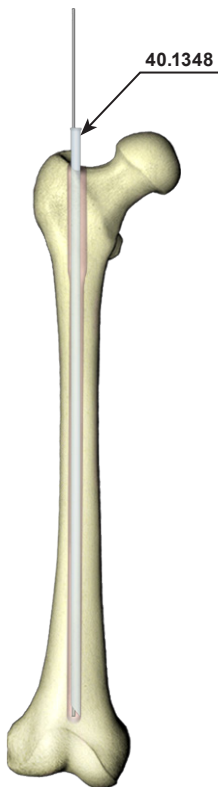

- 4 When using a guide wire which is not included in the instrument set provided, replace it with a guide wire [40.3925.580]. Insert the Teflon Pipe Guide [40.1348] onto the flexible reamer guide until it reaches the end of the medullary canal in distal femur.

Remove the flexible reamer guide.

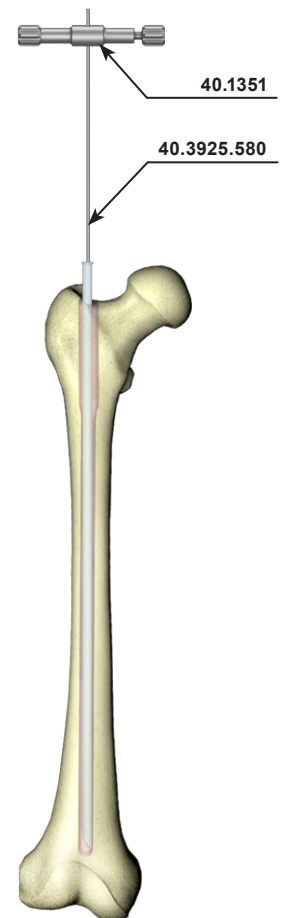

- 5 Mount the Guide rod handle [40.1351] with the Guide rod [40.3925.580] 580 mm in length and advance the system into the Teflon pipe guide until its tip reaches the distal epiphysis of femoral bone.

Remove the the Guide rod handle [40.1351].  
Remove the Teflon pipe guide [40.1348].

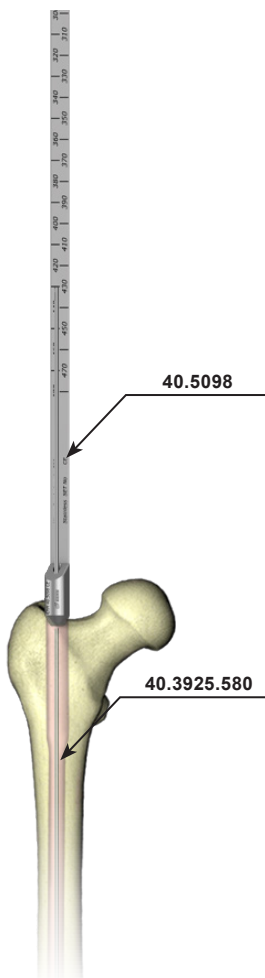

- 6 Insert the Nail Length Measure [40.5098] via the Guide Rod until it rests on the bone. Read the length on the nail measure to assess the length of intramedullary nail. Remove the Nail Length Measure from the Guide Rod. In the case of using the solid nail, remove the Guide Rod. Medullary canal is ready for nail insertion.

- 7 Use the connecting screw:
- [40.5095] in the case of using reconstruction and compression nail,
  - [40.5094] in the case of using universal nail with the Wrench S10 [40.5526.100], to fix the intramedullary nail to the Targeter arm [40.5091].

Mount the Distal targeter D [40.5093] with the Targeter arm. With a pair of the Set Blocks 9/4.5 [40.3616] place the slider of the Distal targeter D in line with distal locking holes of intramedullary nail in its distal part.

Secure the slider of the Distal targeter using the Screwdriver S3.5 [40.3604].



**CHECK:**  
Properly set and secured slider of the Distal targeter D makes it possible to set the Set Blocks 9/4.5 into the holes of the nail easily.

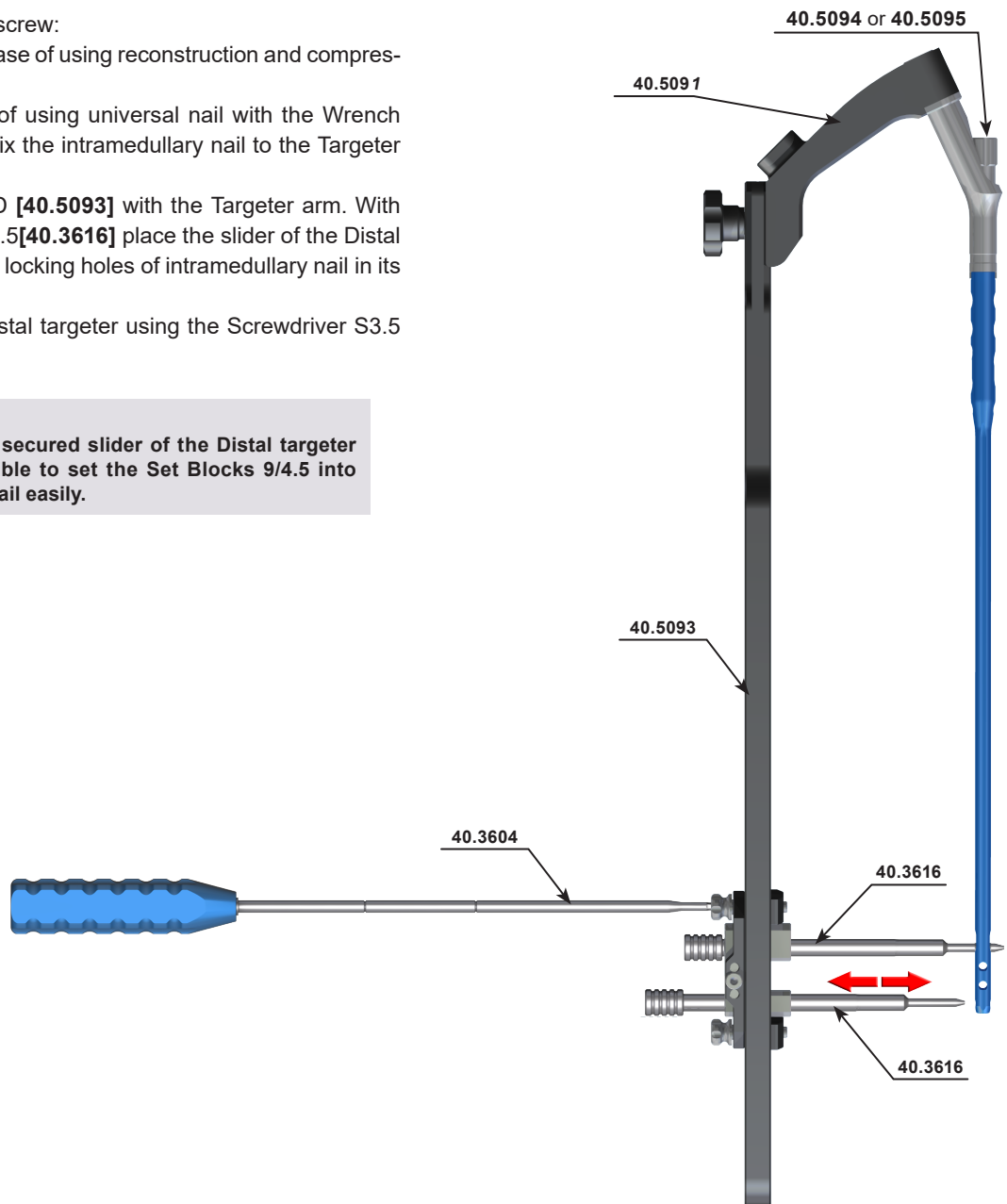

8

I. Attach Angular set block [40.5004.500] to the Targeter D this way it rests its body on slider of distal targeter. Screw maximally locking nut in hole of angular set block.

II. Insert the Pin in the locking nut. Using Screwdriver S3.5 [40.3604] loosen the screws locking the arms of the angular set block and set them this way the end of the Pin inserted in the hole of the Angular set block nut touches the nail in the transverse hole of the medullary nail. In this position lock the arms of angular set block using the Scredriver S3.5 [40.3604].



**Firstly, tightening the locking screw in the column of the set block, lock the indirect arm (1 step). Next, lock the arm with the set block (2 step).**

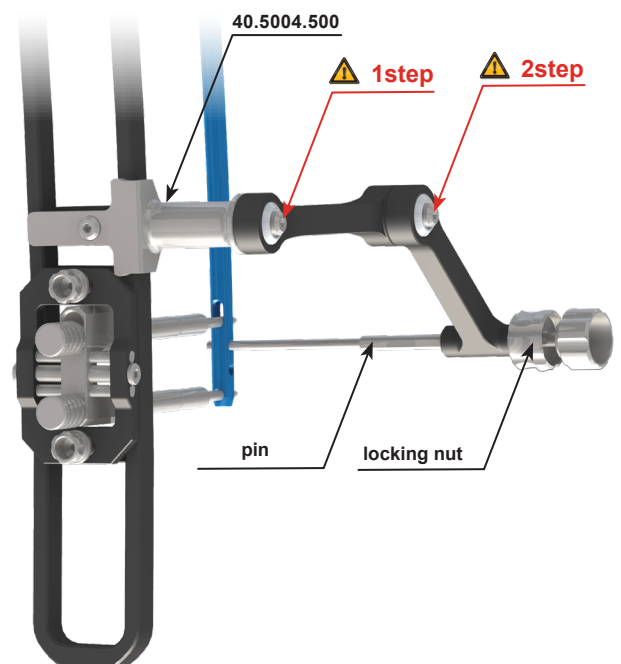

III. Remove the pin from the Angular set block nut.

9

- I. Loosen the screw mounting the Angular targeter to the Targeter D and move it by 10-15 mm. Lock the Angular targeter in the new setting using the Screwdriver S3.5 **[40.3604]**.
- II. Insert the Pin in the hole of the locking nut so that its end leans against the nail. Using the Screw and the Screwdriver S3.5 **[40.3604]** lock the pin in the nut.
- III. Unscrew the locked pin-nut set from the Angular set block. Dismount the distal targeter from the proximal targeter.

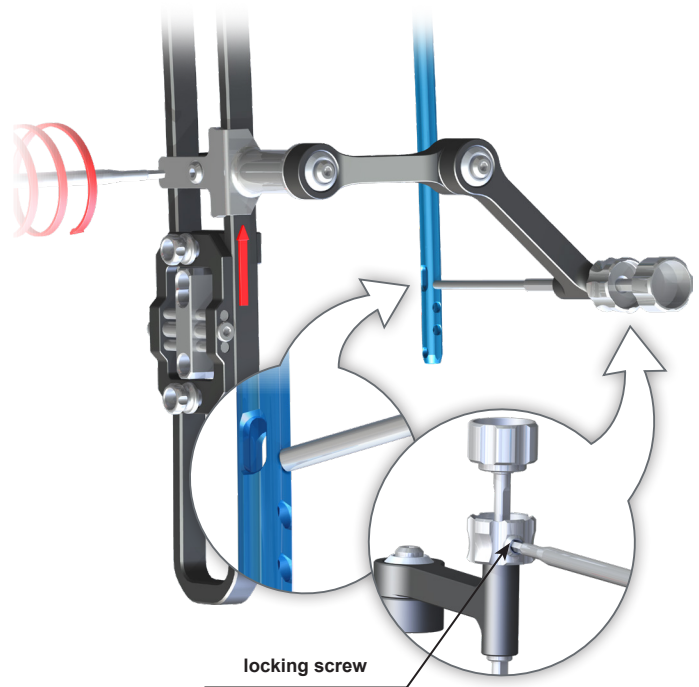

- 10 Mount the Impactor-Extractor **[40.5507]** to the Targeter arm **[40.5091]** with fixed nail. Insert the nail onto the Guide Rod **[40.3925.580]** in medullary canal. Advance the nail by pushing and maneuvering it until it reaches adequate depth. Remove the Guide Rod **[40.3925.580]**. Dismount the Impactor-Extractor **[40.5507]** from the Targeter arm.

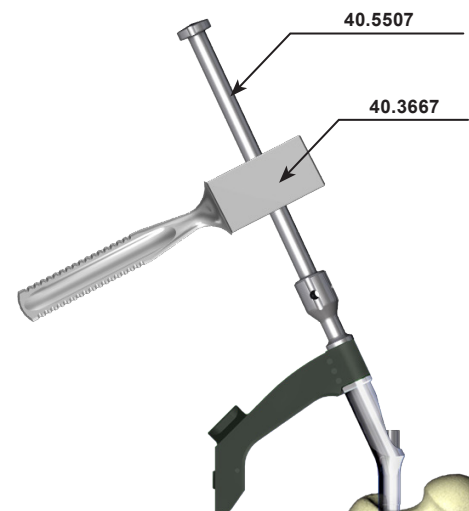

- 10a Mount the Targeter 135 **[40.5097]** on the Targeter arm **[40.5091]**. Insert Kirschner wire in the hole (*marked "0"*) of the Targeter 135 **[40.5097]** to verify correct placement of the nail. The end of the wire shows the beginning of the nail.



## IV.2. RECONSTRUCTION METHOD

### IV.2.1. Proximal locking of the nail

#### IV.1.0.A. **OPTION I: Locking with reconstruction screws**

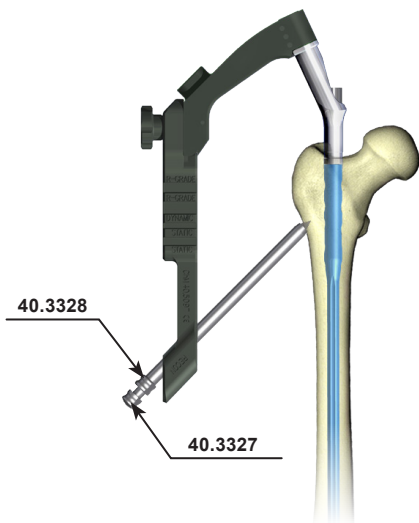

- 11 Mount the Targeter 135 [40.5097] to the Targeter arm [40.5091]. Insert the Protective Guide 11/9 [40.3328] with the Trocar 9 [40.3327] into the first proximal hole of the Targeter 135 [40.5097]. Mark on the skin the entry point for screws and make adequate incision of the soft tissues. Advance the trocar until it reaches the cortex bone and mark the entry point for the drill. Simultaneously advance the Protective Guide together with the Trocar until its tip rests on the cortex bone. Remove the Trocar. Leave the Protective Guide in the hole.

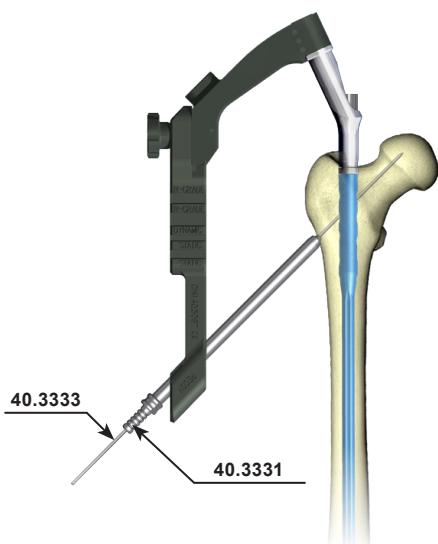

- 12 Insert Kirschner Guide [40.3331] into the Protective Guide. Mount Kirschner wire 2.0/380 [40.3333] on the surgical drive and place KW into the femoral neck but do not perforate the femoral head. The above step should be controlled with X-Ray (*image in the drawing plane*). Verify the position of KW in the lateral view. The wire should be in the middle of the neck, deviation is acceptable if allows for the screw insertion without damaging outer cortex of the neck. In the case of mis-positioning of the wire, repeat the step.

Leave: Kirschner Guide, Protective Guide and Kirschner wire in place.

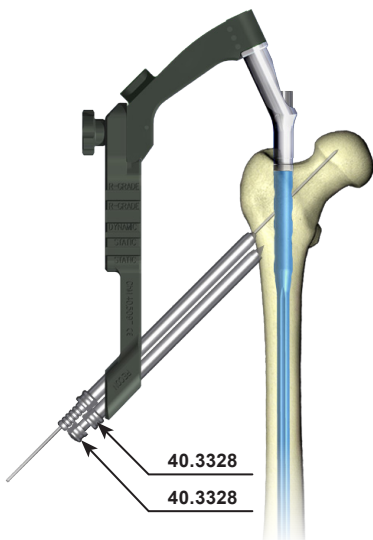

- 13 Insert the Protective Guide 11/9 [40.3328] with the Trocar 9 [40.3327] into the second hole in the Targeter 135 [40.5097]. Advance the Trocar until it reaches the cortex bone and mark the entry point for the drill. Advance the Protective Guide together with the Trocar until it touches the bone.

Remove the Trocar.  
Leave the Protective Guide in the hole.

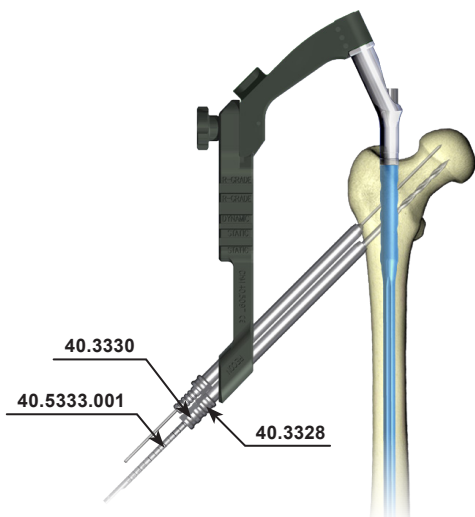

- 14 Insert the Drill Guide 9/4.5 [40.3330] (with two grooves on the handle) into the Protective Guide 11/9 [40.3328] placed in the second hole of the targeter. Mount the Drill With Scale 4.5/370 [40.5333.001] on the surgical drive and advance it through the drill guide. Drill the hole in the femoral neck (through the proximal hole in the nail) until it reaches adequate depth, but do not perforate the head. The scale on the Drill shows the length of the locking element. Control the drilling process with the X-Ray image intensifier. Remove the Drill and the Drill Guide. Leave the Protective Guide in the hole of targeter.

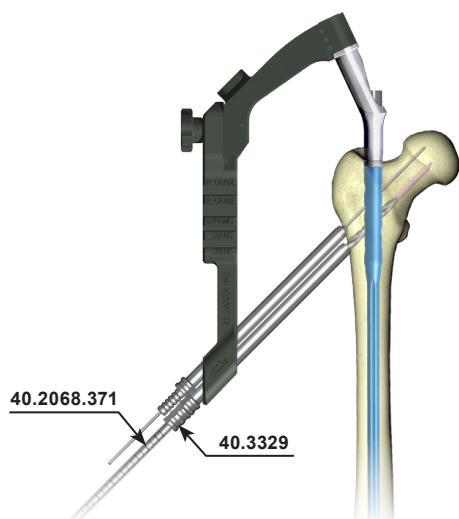

- 15 Insert the Drill Guide 9/6.5 [40.3329] (with three grooves) into the Protective Guide 11/9 [40.3328]. Mount the Drill 6.5/370 [40.2068.371] on the surgical drive and advance it through the drill guide. Ream the hole in the femoral neck for the depth approx. 30mm lesser than the hole drilled before with 4.5 drill (due to the length of the thread of the reconstruction screw).



Control the drilling process with the X-Ray image intensifier.

Remove the Drill and the Drill Guide. Leave the Protective Guide in the hole of targeter.

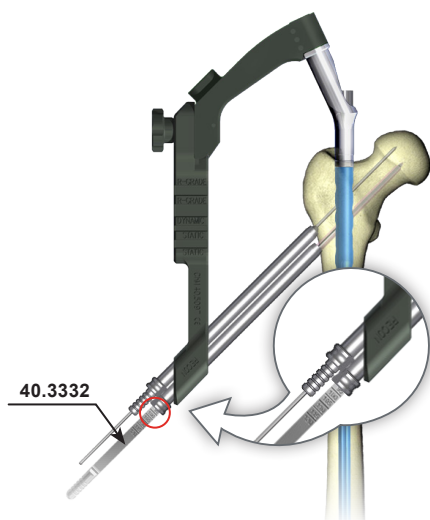

- 16 Insert the Reconstruction Screw Length Measure [40.3332] through the Protective Guide into the drilled hole until it reaches its end. Read the length of the reconstruction screw on the measure. During the measurement the end of the Protective Guide should rest on the cortex bone.

Remove the Screw Length Measure. Leave the Protective Guide in the hole of targeter.

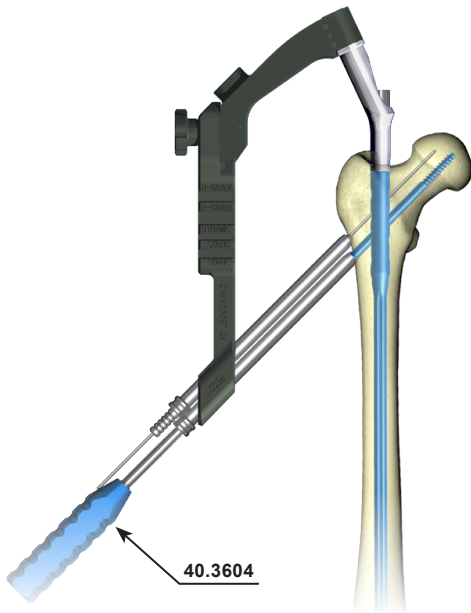

- 17 Insert the tip of the Screwdriver S3.5 [40.3604] into the hexagonal socket of the selected reconstruction screw. Then advance both into the Protective Guide. Insert the reconstruction screw in the prepared hole until the head of the screw reaches the cortex bone (*the groove on the screwdriver shaft matches the edge of protective guide*).

Remove the Screwdriver.

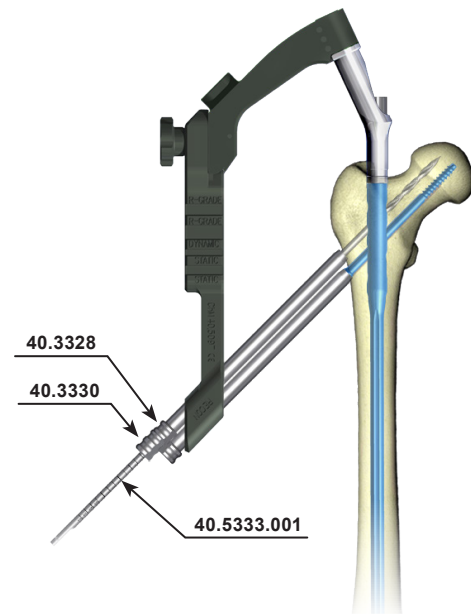

- 18 Remove Kirschner wire and Kirschner Guide from the Protective Guide 11/9 [40.3328] of the first hole. Insert the Drill Guide 9/4.5 [40.3330] (*with two grooves on the handle*) into the Protective Guide 11/9 [40.3328] (*with one groove*) left in hole of the targeter.

Mount the Drill With Scale 4.5/370 [40.5333.001] on the surgical drive and advance it through the drill guide. Drill the hole in the femoral neck (*through the proximal hole in the nail*) until it reaches adequate depth, but do not perforate the head. The scale on the drill shows the length of the locking element.



Control the drilling process with the X-Ray image intensifier.

Remove the Drill and the Drill Guide.  
Leave the Protective Guide in the hole of targeter.

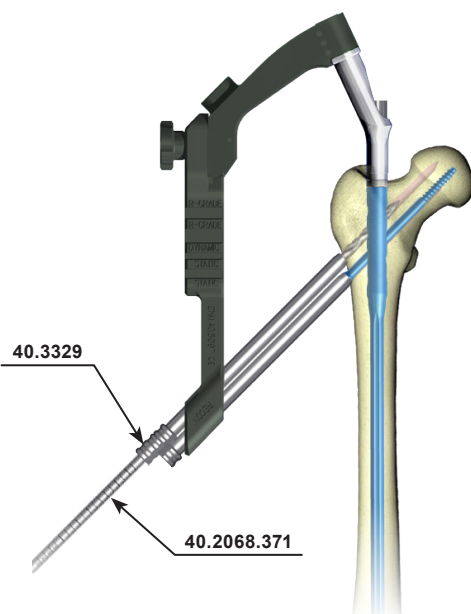

- 19 Insert the Drill Guide 9/6.5 [40.3329] (*with three grooves*) into the Protective Guide. Mount the Drill 6.5/370 [40.2068.371] on the surgical drive and advance it through the drill guide. Ream the hole in the femoral neck for the depth approx 30mm lesser than before drilled hole with 4.5 drill (*due to the length of the thread on the reconstruction screw*).



Control the drilling process with the X-Ray image intensifier.

Remove the Drill and the Drill Guide.  
Leave the Protective Guide in the hole of targeter.



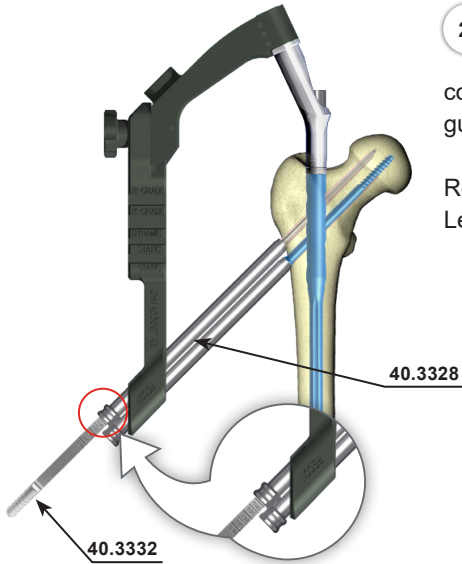

- 20 Insert the Reconstruction Screw Length Measure [40.3332] through the Protective Guide into the drilled hole until it reaches its end. Read the length of the reconstruction screw on the measure. During the measurement the end of the protective guide should rest on the cortex bone.

Remove the Screw Length Measure.  
Leave the Protective Guide in the hole of the targeter.

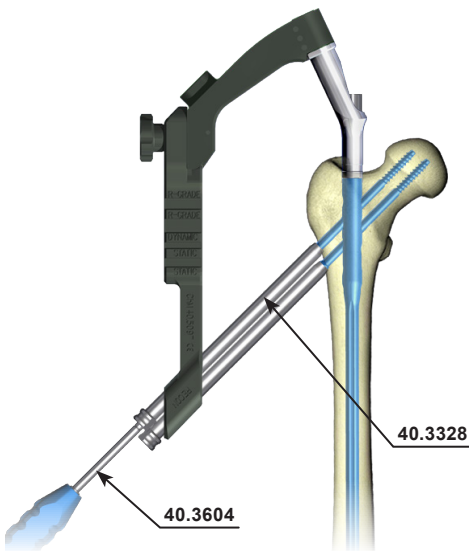

- 21 Insert the tip of the Screwdriver S3.5 [40.3604] into the hexagonal socket of the selected reconstruction screw. Then advance both into the Protective Guide. Insert the reconstruction screw in the prepared hole until the head of the screw reaches the cortex bone (*the groove on the screwdriver shaft matches the edge of protective guide*). Remove the Screwdriver S3.5 and Protective Guide.

**IV.1.0.B. OPTION II: Locking nail with reconstruction cannulated screws**

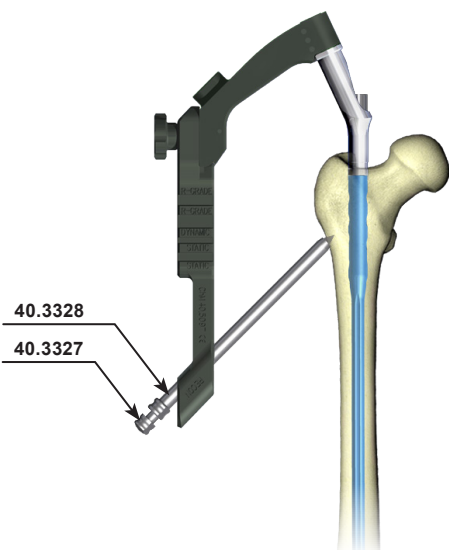

- 22 Insert the Protective Guide 11/9 [40.3328] with the Trocar 9 [40.3327] into the first proximal hole in the Targeter 135 [40.5097]. Mark the entry point for the screw and make the adequate incision of the soft tissues. Advance the Trocar until it reaches the cortex bone and mark the entry point for the drill. Advance the Protective Guide together with the Trocar until it touches the bone.

Remove the Trocar.  
Leave the Protective Guide in the hole.

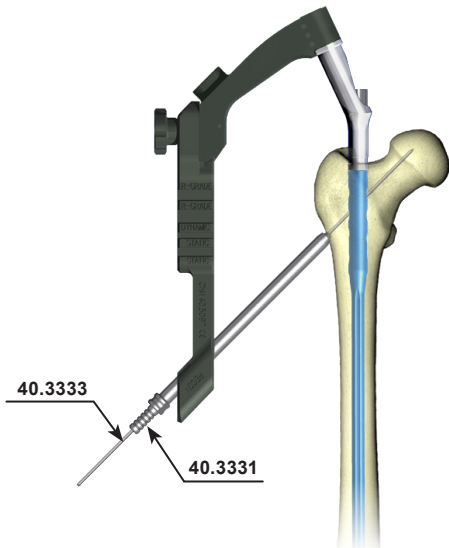

- 23 Insert Kirschner Guide [40.3331] and Kirschner Wire 2.0/380 [40.3333] into the Protective Guide 11/9 [40.3328]. Mount KW in the surgical drive and advance into the femoral neck but do not perforate the femoral head. The above step should be controlled with X-Ray (A/P view). Verify the position of KW in the lateral view. KW should be in the middle of the neck, deviation is acceptable if allows screw to be inserted without damaging outer cortex of the neck. Use Kirschner Wire 2.0/380 [40.3333] only. In the case of mis-positioning of the wire, repeat this step.

Remove Kirschner guide.  
Leave Kirschner wire in place.

- 24 Insert the Cannulated screw length measure [40.3676] onto Kirschner wire drilled into the femoral neck until its tip touches the Protective Guide. Read the length of the reconstruction cannulated screw defined by the end of Kirschner wire. During the measurement the end of the measure should rest on the cortex bone.

Remove the Screw Length Measure.  
Leave Kirschner wire in place.

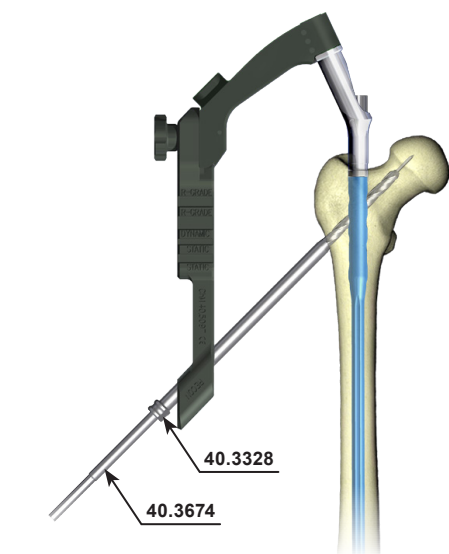
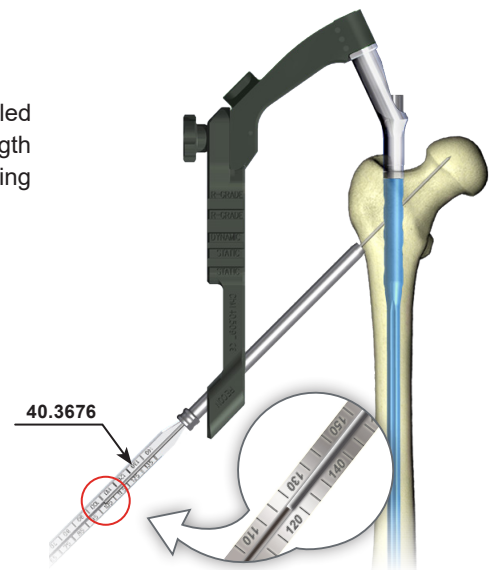

- 25 Mount the Cannulated Drill 6.5 [40.3674] in the surgical drive and advance via Kirschner wire mounted in the femoral neck. Drill the hole through the first cortex (up to the nail placed in the medullary canal).

Remove the Cannulated Drill.  
Leave Kirschner Wire in place.

- 26 Insert the selected reconstruction cannulated screw onto Kirschner wire. Insert, using the Cannulated Screwdriver [40.3675] via Kirschner wire, a reconstruction cannulated screw that will pass through the proximal hole of the nail until its head reaches cortex bone.

Remove the Screwdriver and Kirschner Wire.  
Kirschner wire is single use instrument.



**NOTE!** To insert second reconstruction screw into the second hole in targeter, repeat steps [21] to [24].

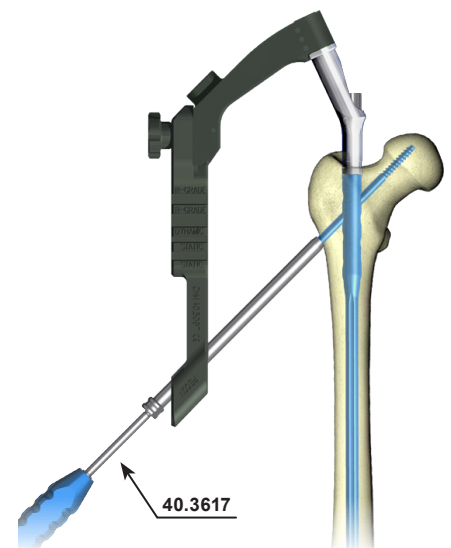

Correctness of femoral neck fixation should be verified by taking X-Ray image in two projections. Small overall dimensions of the targeter 135 which is additionally angled of antetorsion angle allows for taking X-Ray image in lateral position (*c-arm is then positioned at small angle in relation to targeter position*). Nail with its locking elements both seen at radiological image can be helpful in confirming the correctness of locking.



#### IV.2.2. Distal locking of the nail

Prior to distal locking of the nail, do the following:

1. Mount the Distal targeter D [40.5093] on the Targeter arm [40.5091] and secure it with a locknut (*provided with the targeter*). Mount also Angular set block. If properly installed, the signs RIGHT or LEFT on both targeters should comply.
2. Verify with the X-Ray the position of holes in the nail and in the targeter. The centers of the holes in nail and targeter have to be in line.

27 Insert the Protective Guide 9/6.5 [40.3614] (*with one groove on the handle*) with the Trocar 6.5 [40.3617] into the hole of the angular set block. Mark the entry point and make the adequate incision of the soft tissues. Advance the Trocar until it reaches the cortex bone and mark the entry point for the drill. Advance the Protective Guide together with the Trocar until it touches the bone.

Remove the Trocar.  
Leave the Protective Guide in the hole of the angular set block.

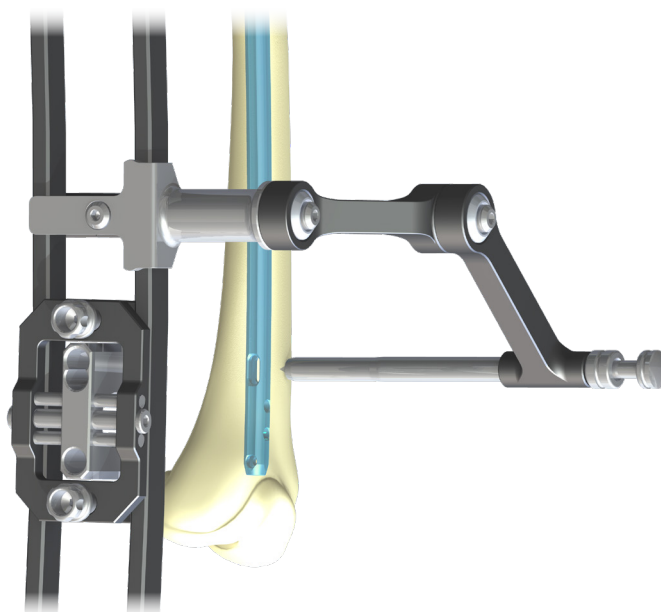

- 28 Insert the Drill Guide 6.5/3.5 [40.3615] (with two grooves) into the Protective Guide left in the angular set block. Mount the Drill 3.5/270 [40.1386] on the surgical drive and advance it through the drill guide. Drill (under image intensifier control) the hole in the femoral shaft until the drill reaches the nail. Remove: the drill, drill guide and protective guide.

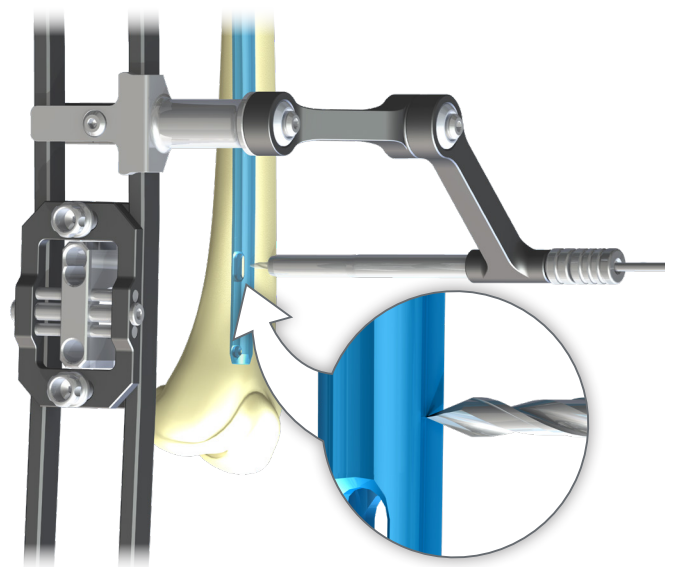

- 29 Screw in maximally the pin and the nut in the hole of the angular set block. Afterwards, proceed with locking the nail from the slider of the Distal targeter.

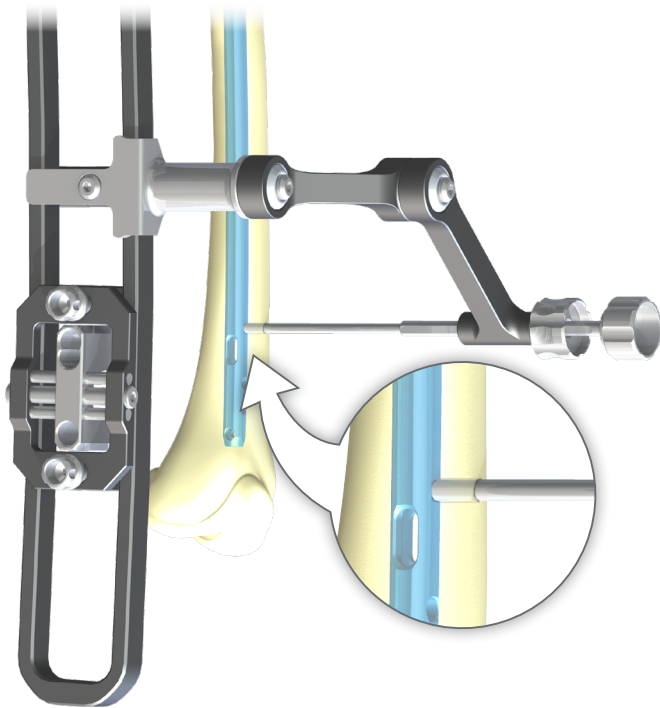

- 30 Insert the Protective Guide [40.3614] (with one groove) with the Trocar 6.5 [40.3617] into the proximal hole of the Distal targeter D. Mark the entry point for the drill and make the adequate incision of the soft tissues. Using the trocar, mark the entry point for the drill. Advance the Protective Guide together with the Trocar until it touches the bone.

Remove the Trocar.  
Leave the Protective Guide in the hole of the targeter.

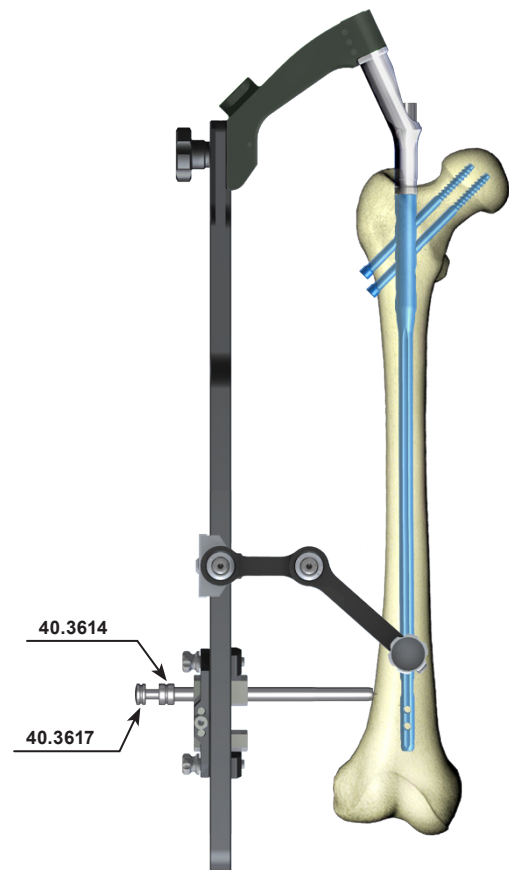

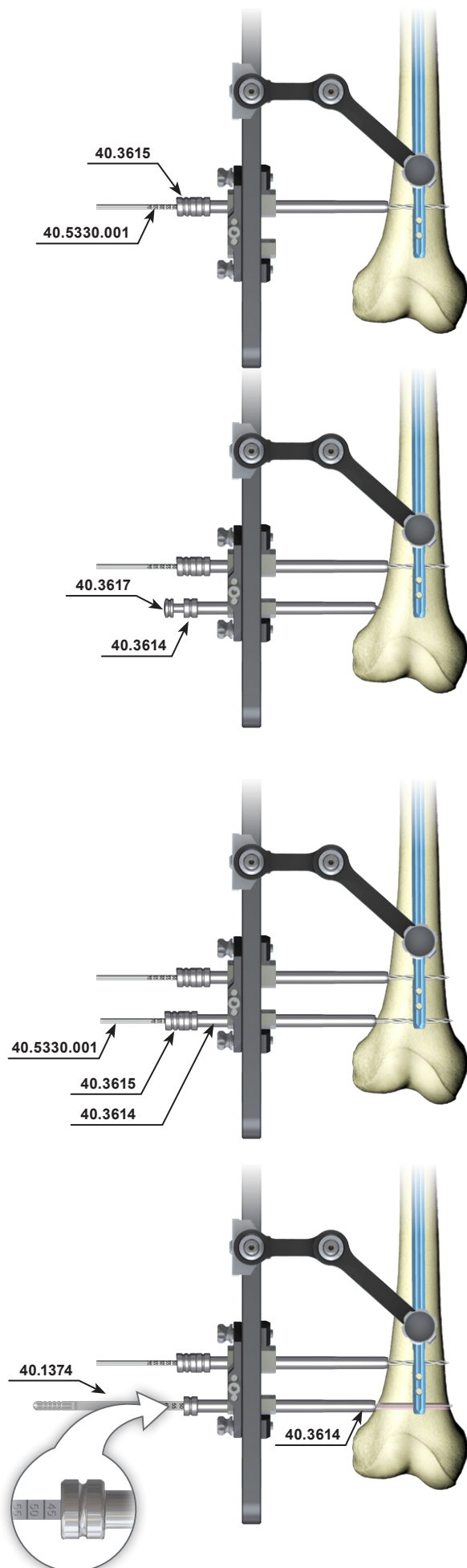

- 31 Insert the Drill Guide 3.5 [40.3615] (with two grooves) into the Protective Guide [40.3614]. Mount the Drill With Scale 3.5/270 [40.5330.001] on the surgical drive and advance it through the Drill Guide. Drill the hole in the femoral shaft through its both cortex layers and the nail hole. The scale on the drill shows the length of the locking element.

Dismount the Drill from the surgical drive.  
Leave the protective guide - drill guide - drill set in place.

- 32 Insert the Protective Guide [40.3614] (with one groove) with the Trocar 6.5 [40.3617] into the second hole of the Distal targeter. Advance the Trocar until it reaches the cortex bone and mark the entry point for the drill. Advance the Protective Guide together with the Trocar until it touches the bone.

Remove the Trocar.  
Leave the Protective Guide in the hole.

- 33 Insert the Drill Guide 6.5/3.5 [40.3615] (with two grooves) into the Protective Guide [40.3614]. Mount the Drill With Scale 3.5/270 [40.5330.001] on the surgical drive and advance it through the Drill Guide. Drill the hole in the femoral shaft through its both cortex layers and the nail hole. The scale on the drill shows the length of the locking element.

Remove the Drill and the Drill Guide.  
Leave the Protective Guide in the targeter hole.

- 34 Insert the Screw Length Measure [40.1374] through the Protective Guide into the drilled hole until its hook reaches the "exit" plane of the hole. Read the length of the locking screw on the B-D measure scale. During the measurement, the tip of Protective Guide should rest on the cortex bone.

Remove the Screw Length Measure.  
Leave the Protective Guide in place.

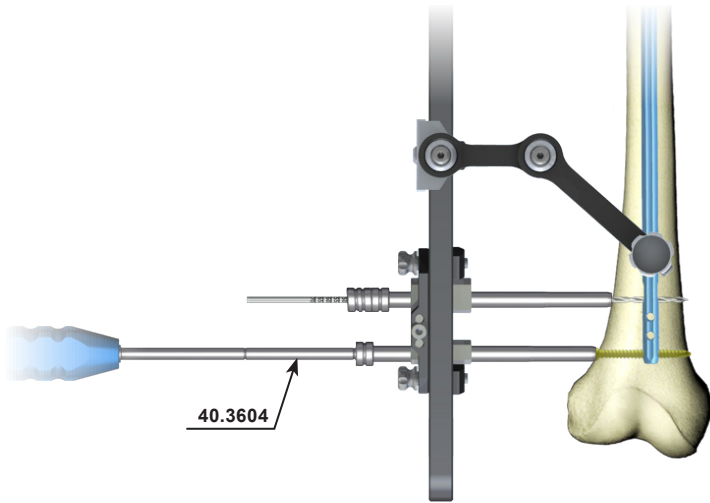

35 Insert the tip of the Screwdriver S3.5 [40.3604] into the hexagonal socket of the selected locking screw. Then advance both into the Protective Guide. Insert the locking screw into prepared hole until the head of the screw reaches the cortex bone (*the groove on the screwdriver shaft matches the edge of the protective Guide*).

Remove the Screwdriver and Protective Guide.

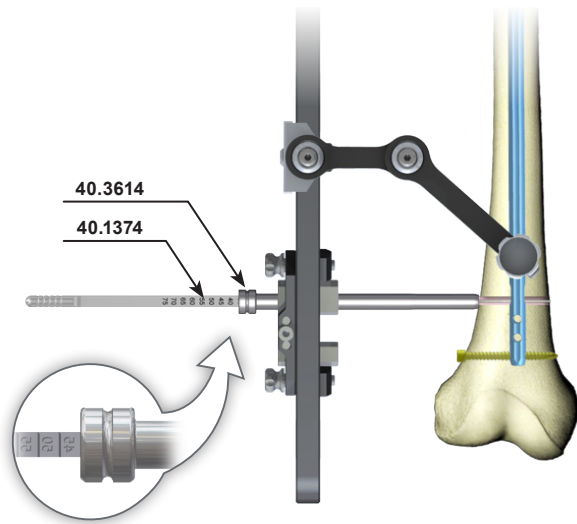

36 Remove the Drill and Drill Guide from the proximal hole of the targeter. Leave the Protective Guide in the hole of the targeter. Insert the Screw Length Measure [40.1374] through the Protective Guide into the drilled hole until its hook reaches the "exit" plane of the hole. Read the length of the locking screw on the B-D measure scale. During the measurement the Protective Guide should rest on the cortex bone.

Remove the Screw Length Measure.  
Leave the Protective Guide in the hole of the targeter.

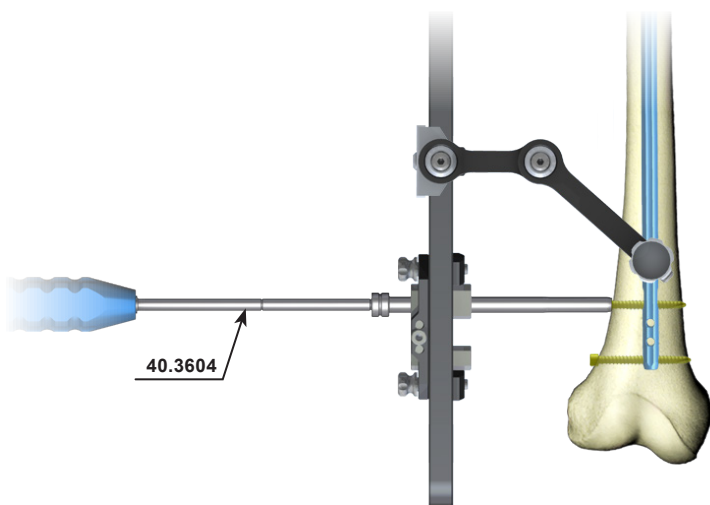

37 Insert the tip of the Screwdriver S3.5 [40.3604] into the hexagonal socket of the selected locking screw. Then advance both into the Protective Guide. Insert the locking screw into the prepared hole until the head of the screw reaches the cortex bone (*the groove on the screwdriver shaft matches the edge of the protective guide*).

Remove the Screwdriver S3.5.

38 After locking the nail in its distal part, remove only one of protective guides via which locking screws in the AP plane were inserted and proceed to locking the nail in the second plane. Unscrew the pin together with the nut from the angular set block. Move the angular set block [40.5004.500] so that it leans against the slider of the distal targeter. Lock the angular set block.

39 Insert Protective guide [40.3614] with Trocar [40.3617] into the hole of the angular set block. Mark the entry point and make the adequate incision of soft tissues. Advance the Trocar until it reaches the cortex bone and mark the entry point for the drill. Advance the Protective Guide together with the Trocar until it touches the bone.

Remove the Trocar.  
Leave the Protective guide in the hole of the Angular set block.

40 Insert Drill guide [40.3615] into Protective guide. Using surgical drive and the Drill 3.5/270mm [40.1386] via drill guide drill the hole through both cortex layers of the bone and the nail hole. Verify the hole under image intensifier control.

Remove the drill.

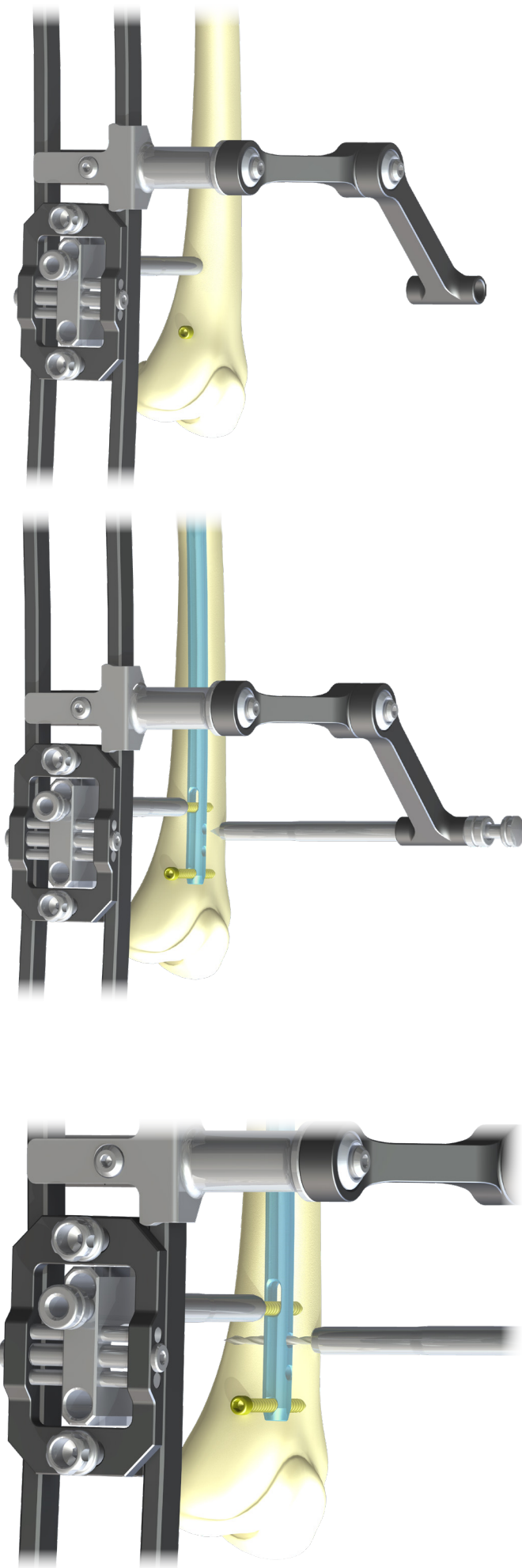

- 41 Insert the Screw Length Measure [40.1374] through the Protective Guide into the drilled hole until its hook reaches the outer side of the second cortex layer. Read the length of the locking screw on the B-D measure scale. During the measurement, the tip of Protective Guide should rest on the cortex bone.

Remove the Screw Length Measure.

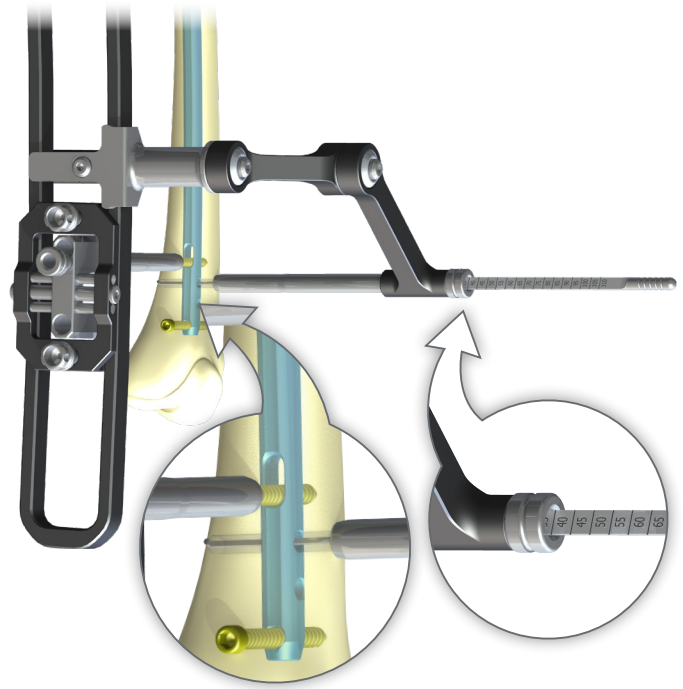

- 42 Insert the tip of the Screwdriver S3.5 [40.3604] into the hexagonal socket of the selected locking screw. Then advance both into the Protective Guide. Insert the locking screw into prepared hole until the head of the screw reaches the cortex bone (the groove on the screwdriver shaft matches the edge of the protective guide).

Remove the Screwdriver and Protective Guide. Dismount the Angular set block and proceed to proximal nail locking.

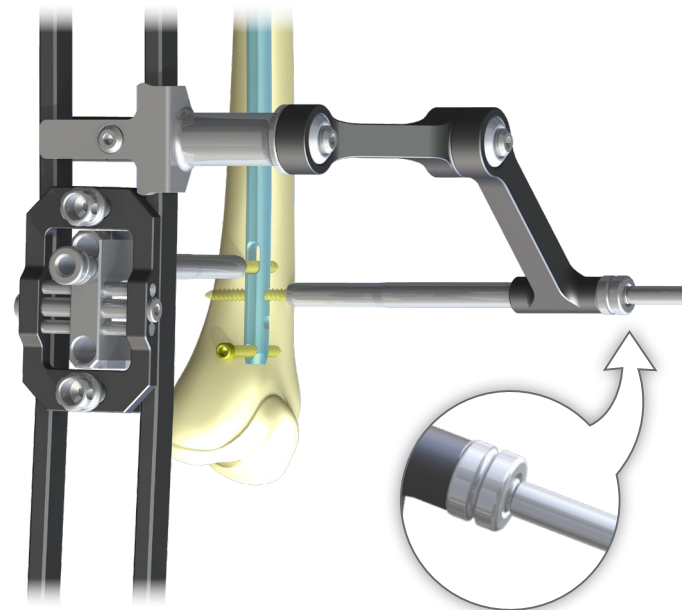



## IV.2.3. Targeter removal, placing End cap

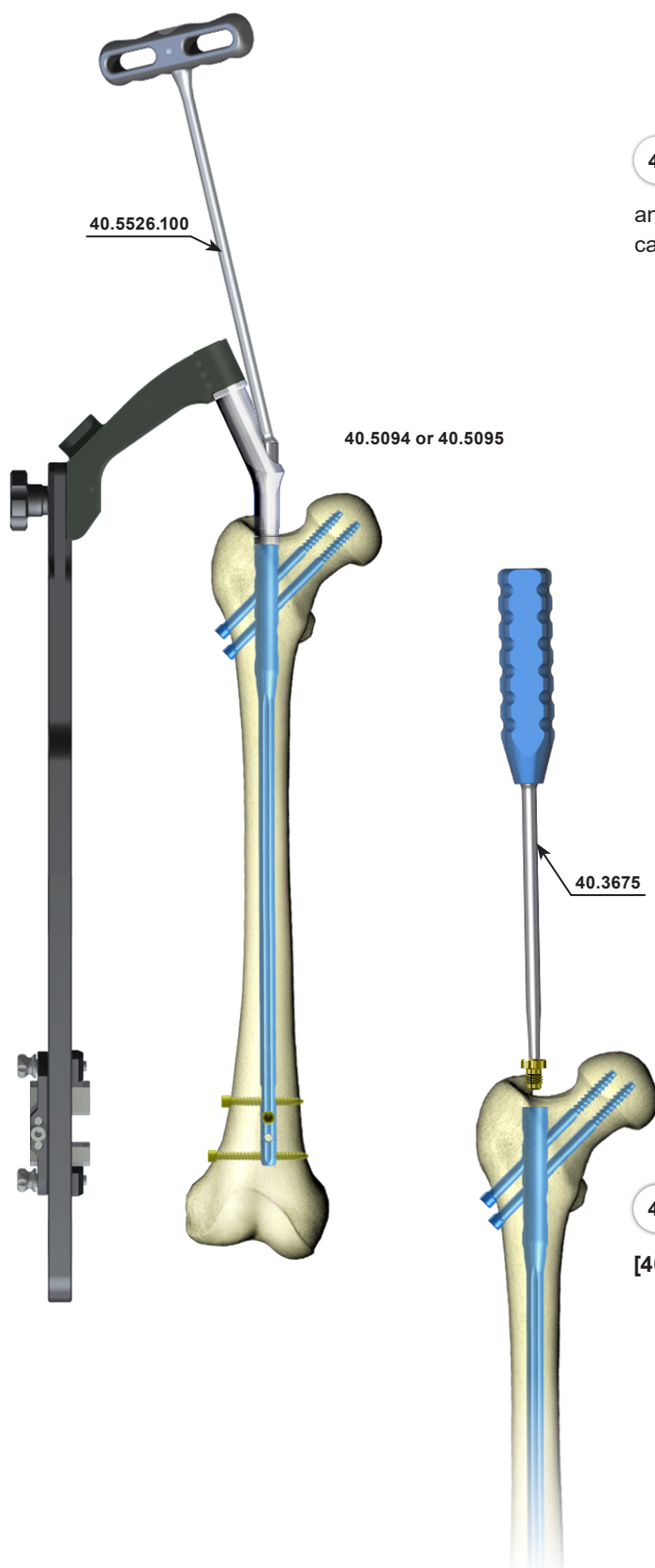

43 Using the Wrench S10 [40.5526.100] unscrew the Connecting Screw [40.5094] or [40.5095] from the nail shaft and dismount the targeter from the nail locked in the medullary canal.

44 In order to secure the inner thread of the nail from bone ingrowth, using the Cannulated Screwdriver S5.0/2.2 [40.3675] insert:

- the End Cap [1.2104.3xx] or [3.2104.3xx] in the case of using universal nail,
- the End Cap [1.2104.4xx] or [3.2104.4xx] in the case of using reconstruction nail.

IV.2.4. Distal locking of the nail - “freehand technique”

With this technique the X-Ray imaging is used to identify the entry points for the drills and to control the drilling process. It is recommended to use the angular attachment with the surgical drive while drilling, so that surgeon’s hands are not directly exposed to radiation. After marking the entry points on the skin, incisions shall be made in the marked places through the soft tissues, each about 1.5cm in length.

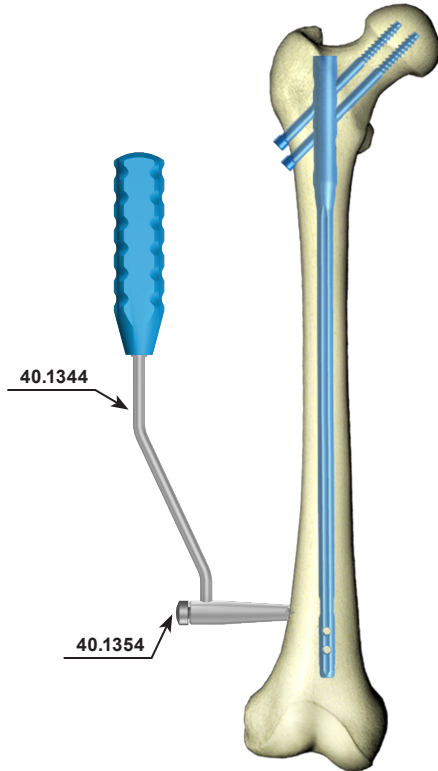

- 45 Using X-Ray device, place the Targeter D [40.1344] in the line with the nail hole. The centers of the holes in the targeter and nail have to match. The teeth of the Targeter D have to be merged in the cortex. Insert the Short Trocar 7 [40.1354] into the hole of the targeter, advance it until reaching the cortex, and mark the entry point for the drill.

Remove the Trocar.  
Leave the Targeter D.

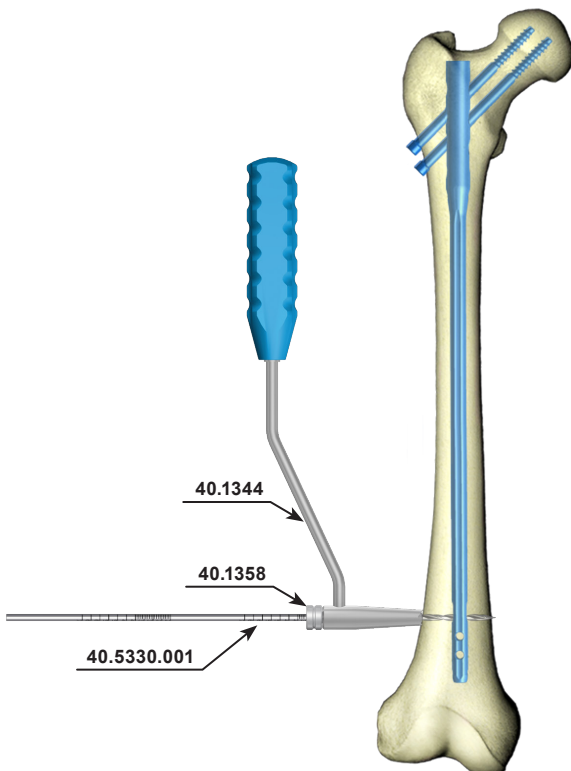

- 46 Insert the Drill Guide Short 7/3.5 [40.1358] into the targeter hole. Mount the Drill With Scale 3.5/270 [40.5330.001] on the surgical drive and advance it through the drill guide. Drill the hole in the femoral shaft through its both cortex layers and the nail hole. The scale on the drill shows the length of the locking element.

Remove the Drill and Drill Guide.  
Leave the Targeter in place.

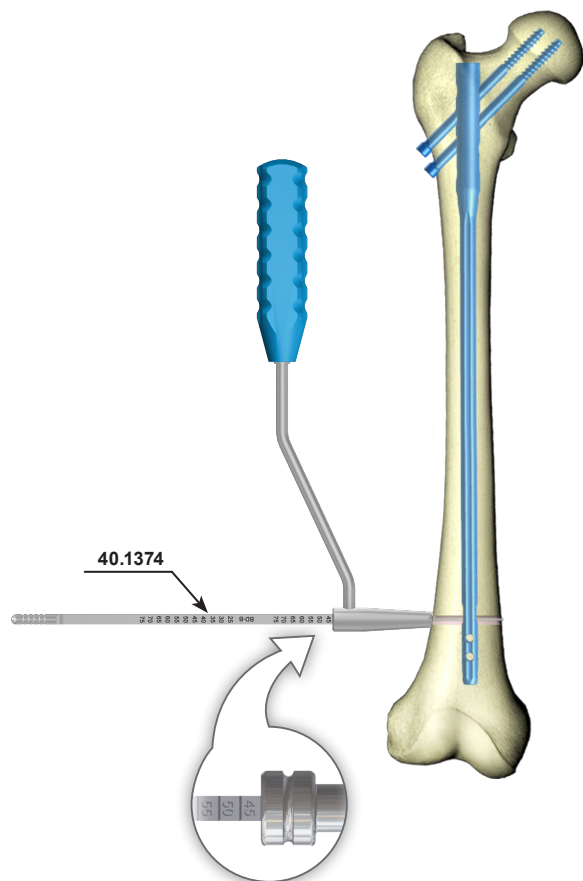

- 47 Insert the Screw Length Measure [40.1374] through the Protective Guide into the drilled hole until its hook reaches the "exit" plane of the hole. Read the length of the locking screw on the scale D.

Remove the Screw Length Measure.  
Leave the Targeter in place.

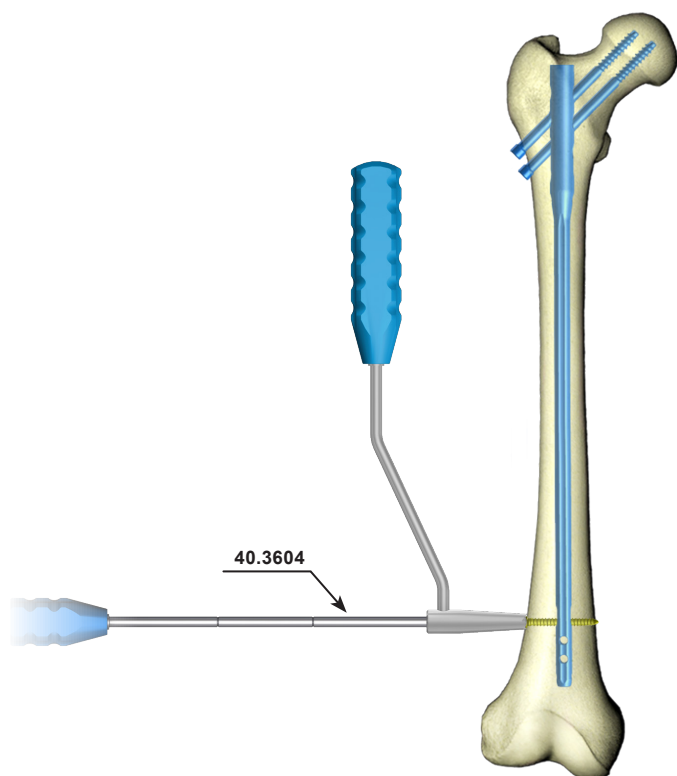

- 48 Insert the tip of the Screwdriver S3.5 [40.3604] into the hexagonal socket of the selected locking screw. Then advance both into the hole of the Targeter. Insert the locking screw until its head reaches the cortex bone.

Remove the Screwdriver S3.5 and the Targeter.

### IV.3. DYNAMIC AND COMPRESSION METHODS

#### IV.3.1. Distal locking of the nail

Prior to distal locking of the nail, do the following:

1. Mount the Distal targeter D [40.5093] to the targeter arm [40.5091] and secure it with the collar bolt.  
*If properly installed, the signs RIGHT or LEFT on both targeters should comply.*
2. Verify, using the X-Ray device, the position of nail holes and in distal targeters holes. The centers of the holes in the nail and in distal targeters have to be in line.

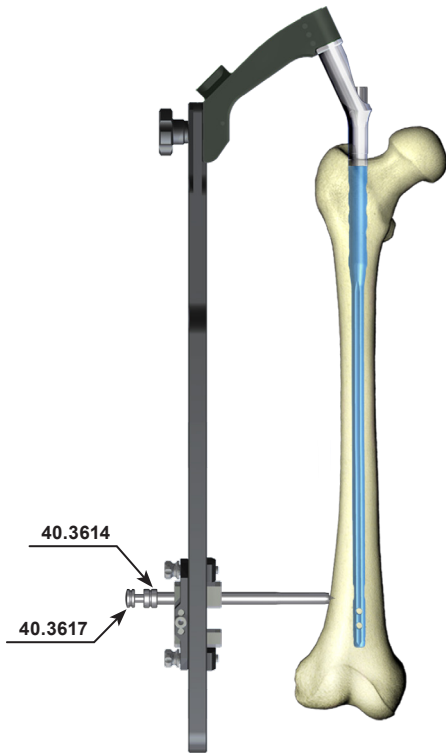

- 49 Insert the Protective Guide [40.3614] (with one groove on the handle) with the Trocar 6.5 [40.3617] into the proximal hole of the distal targeter D. Mark the entry point for the locking screw on the skin and make adequate incision through the soft tissues. Advance the Trocar until it reaches cortex and mark the drill entry point. Advance Protective Guide together with the Trocar until it touches the cortex bone.

Remove the Trocar.  
Leave the Protective Guide in the hole of the targeter.



**NOTE!** For the rest of the procedure follow the subchapter IV.2.2 of these instructions.

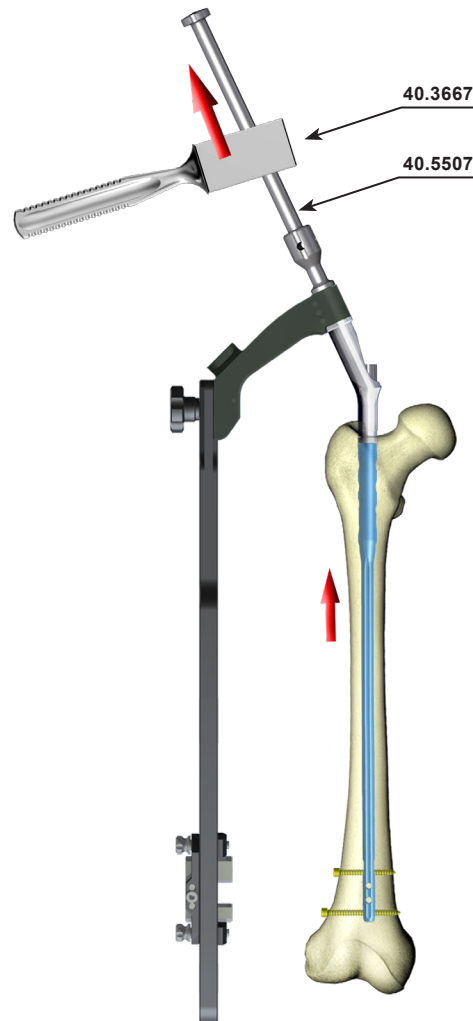

- 50 It is possible to make reduction of fracture after locking the nail in distal part by slightly knocking the nail up, and then locking the nail in proximal part.

## IV.3.2. Proximal locking of the nail



**NOTE!** In compression and dynamic methods insertion shall be done using the hole of the Targeter 135 [40.5097] marked as DYNAMIC.

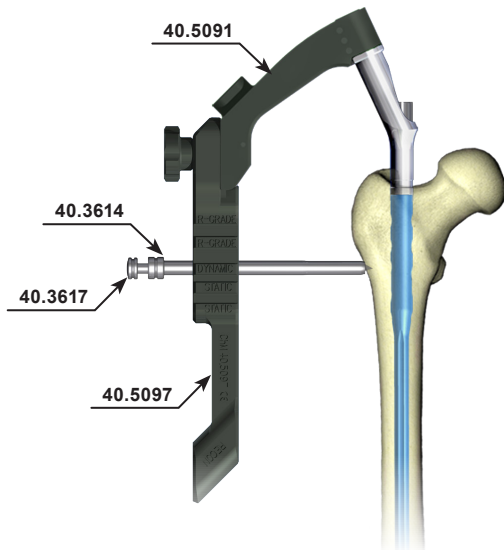

- 51 Mount the Targeter 135 [40.5097] on the Targeter arm [40.5091]. Insert the Protective Guide 9/6.5 [40.3614] (with one groove on the handle) with the Trocar 6.5 [40.3617] into the proximal hole of the Targeter 135 [40.5097]. Mark on the skin the entry point for the locking screw and make adequate incision through soft tissues about 1.5cm in length. Advance the trocar until it reaches the cortex and mark the drill entry point. Advance the Protective Guide together with the Trocar until it touches the cortex.

Remove the Trocar.  
Leave the Protective Guide in the hole of the targeter.

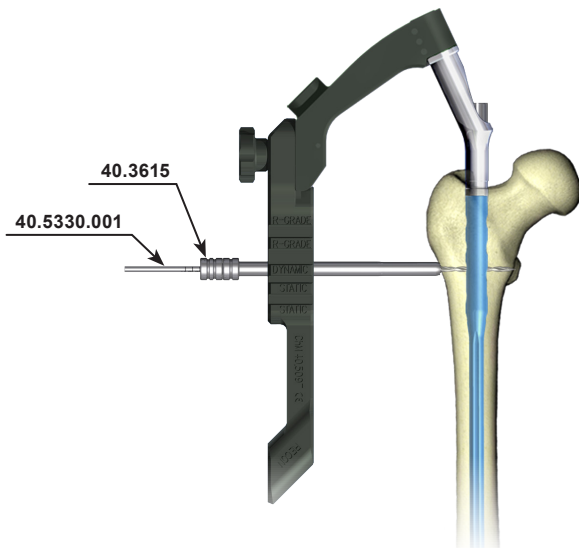

- 52 Insert the Drill Guide 6.5/3.5 [40.3615] (with two grooves) into the protective guide. Mount the Drill With Scale 3.5/270 [40.5330.001] on the surgical drive and advance it through the Drill Guide. Drill the hole in the femur through its both cortex layers and the hole in the nail. The scale on the drill shows the length of the locking element.

Remove the Drill and Drill Guide.  
Leave the Protective Guide in the hole of the targeter.

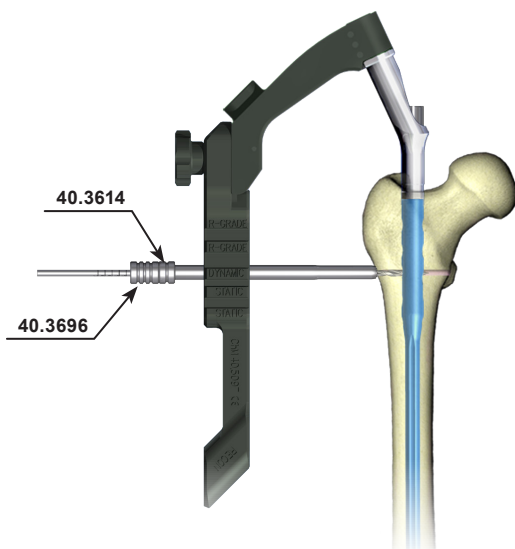

- 53 Insert the Drill Guide 6.5/4.5 [40.3696] into the Protective Guide 9/6.5 [40.3614]. Mount the Drill 4.5/270 on the surgical drive and advance it through the drill guide. Drill the hole in the femur only through its first cortex up to the nail hole.

Remove the Drill and Drill Guide.  
Leave the Protective Guide in the hole of the targeter.

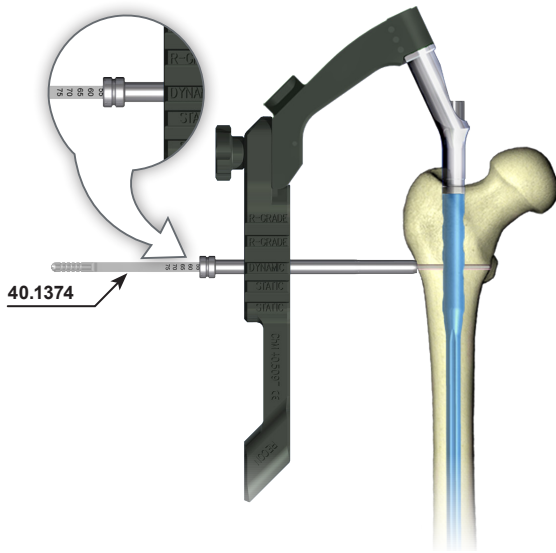

54 Insert the Screw Length Measure [40.1374] through the protective guide into the drilled hole until its hook reaches the “exit” plane of the hole. Read the length of the locking screw on the Measure scale B-D. During the measurement the end of the Protective Guide should rest on the cortex.

Remove the Screw Length Measure.  
Leave the Protective Guide in the hole of the targeter.

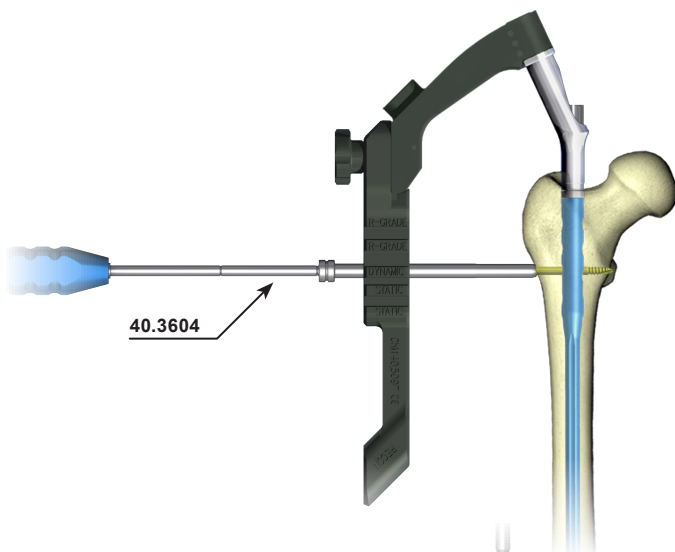

55 Insert the tip of the Screwdriver S3.5 [40.3604] into the hexagonal socket of the selected locking screw. Then advance both into the Protective Guide. Insert the locking screw into the prepared hole until the head of the screw reaches the cortex of the bone (*the groove on the screwdriver shaft matches the edge of the protective guide*).

Remove the Screwdriver and Protective Guide.

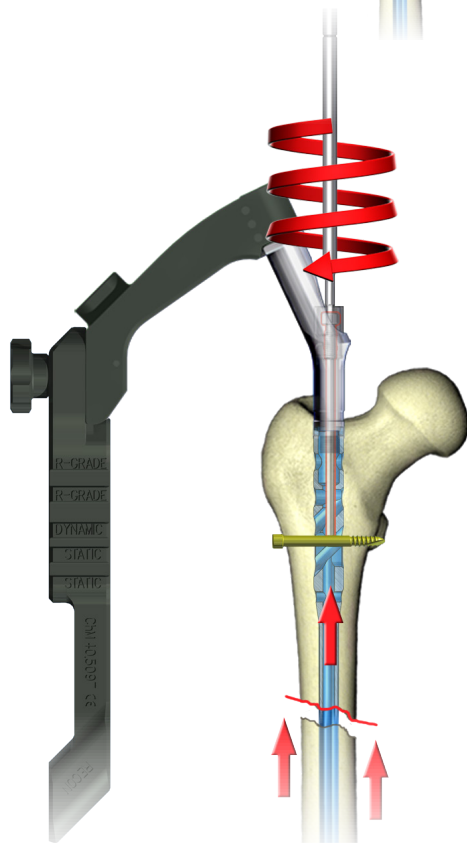

55a In order to make the intraoperative compression, using the Screwdriver S3.5 [40.3604] insert the Compression Screw [40.5096] into the Connecting Screw M10x1 that connects intramedullary nail with the Targeter arm. When front of the screw reaches the shaft of locking screw, further screwing will cause the compression of bone fragments. The above steps should be controlled with X-Ray image intensifier to observe the interfragmental slot.

55b In order to maintain the bone fragments compression, lock the screw by using hole STATIC placed further from DYNAMIC hole. Repeat steps 41-45.

**IV.3.3. Targeter removal**

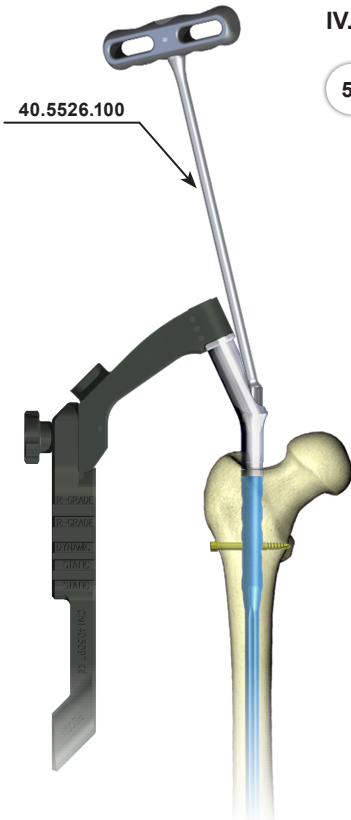

- 56 Using the Wrench S10 [40.5526.100] unscrew the Connecting Screw [40.5094] or [40.5095] from the nail shaft and dismount the targeter from the nail locked in the medullary canal

**IV.3.4. Compression screw insertion**

- 57 Using the Screwdriver S3.5 [40.3604] insert the Compression Screw in the threaded hole of the nail shaft. The surgeon decides about the level of compression.

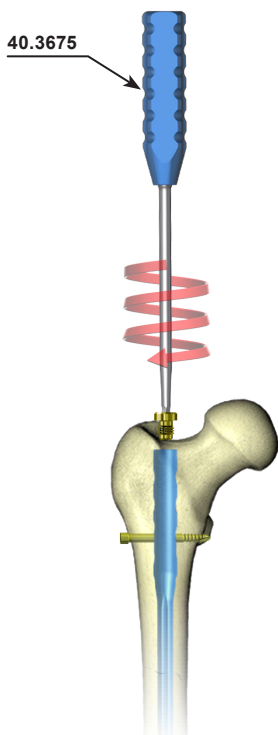
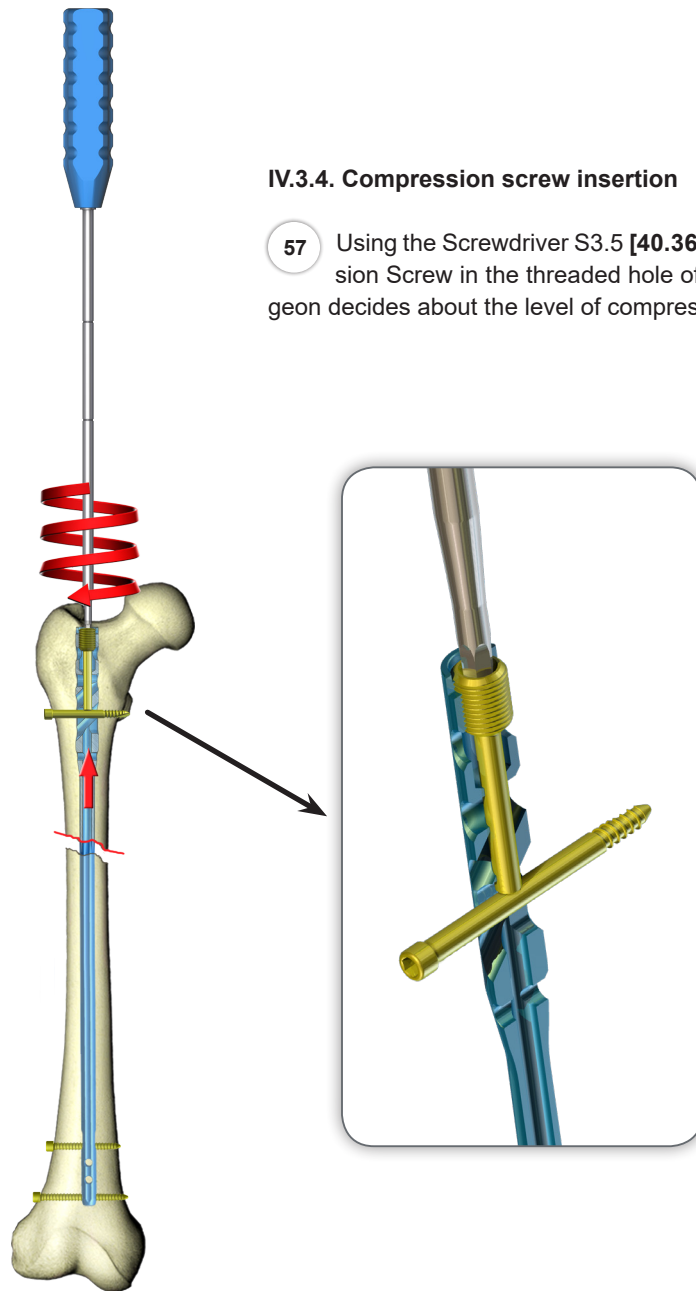

**IV.3.5. End cap insertion (DYNAMIC method only)**

- 58 In order to secure the inner thread of the nail from bone ingrowth, using the Cannulated Screwdriver S5.0/2.2 [40.3675] insert:
- the End Cap [1.2104.3xx] or [3.2104.3xx] in the case of using universal nail,
  - the End Cap [1.2104.4xx] or [3.2104.4xx] in the case of using compression nail.

## IV.4. STATIC METHOD

### IV.4.1. Distal nail locking

Prior to distal locking of the nail, do the following:

1. Mount the Distal targeter D [40.5093] to the targeter arm [40.5091] and secure it with the collar bolt.  
If properly installed, the signs *RIGHT* or *LEFT* on both targeters should comply.

2. Verify, using the X-Ray device, the position of nail holes and in distal targeters holes. The centers of the holes in the nail and in distal targeters have to be in line.

59 Insert the the Protective Guide 9/6.5 [40.3614] (with one groove on the handle) with the Trocar 6.5 [40.3617] into the hole of distal targeter D. Mark the entry point for the locking screw on the skin and make adequate incision through the soft tissues. Advance Trocar until it reaches cortex bone and mark the drill entry point. Advance Protective Guide together with the Trocar until it touches the cortex.

Remove the Trocar.

Leave the Protective Guide in the hole of the targeter.



**NOTE!** For the rest of the procedure follow the subchapter IV.2.2 of these instructions.

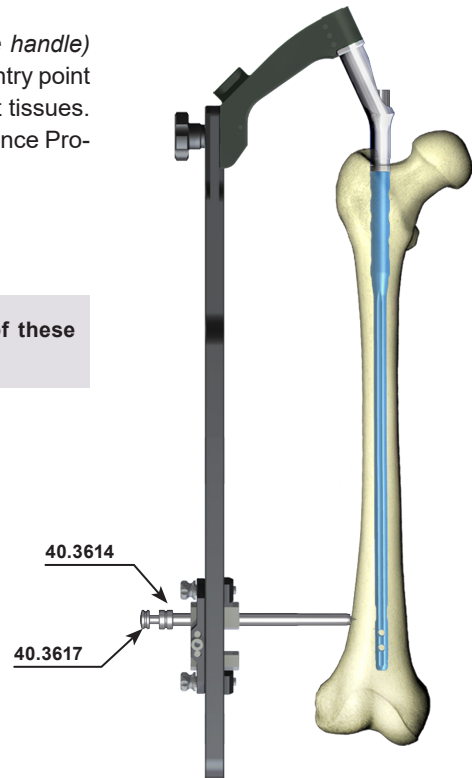

### IV.4.2. Proximal nail locking



**NOTE!** In static method of femoral fixation to lock the intramedullary nail, distal hole of Targeter 135 [40.5097] marked *STATIC* shall be used. The second hole (proximal) may be used for locking with second locking screw.

60 Insert the Protective Guide 9/6.5 [40.3614] (with one groove on the handle) with the Trocar 6.5 [40.3617] into the distal hole of the targeter 135. Mark the entry point for the locking screw on the skin and make adequate about 1.5cm long incision through the soft tissues. Advance the trocar until it reaches the cortex and mark the entry point for the drill. Advance Protective Guide together with the Trocar until it touches the cortex.

Remove the Trocar.

Leave the Protective Guide in the hole of the targeter.

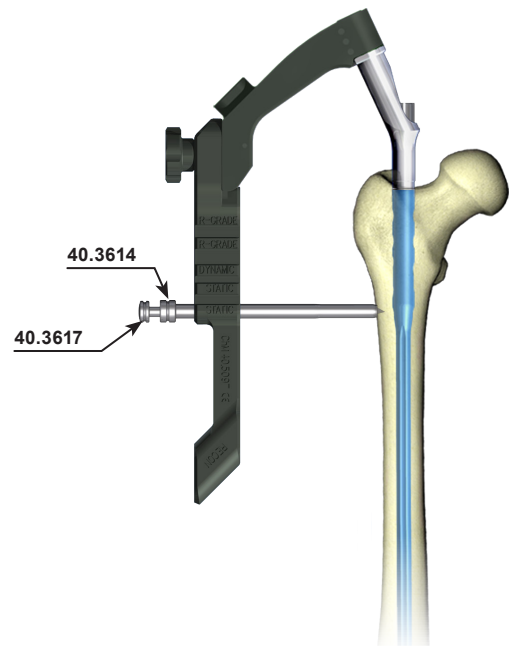



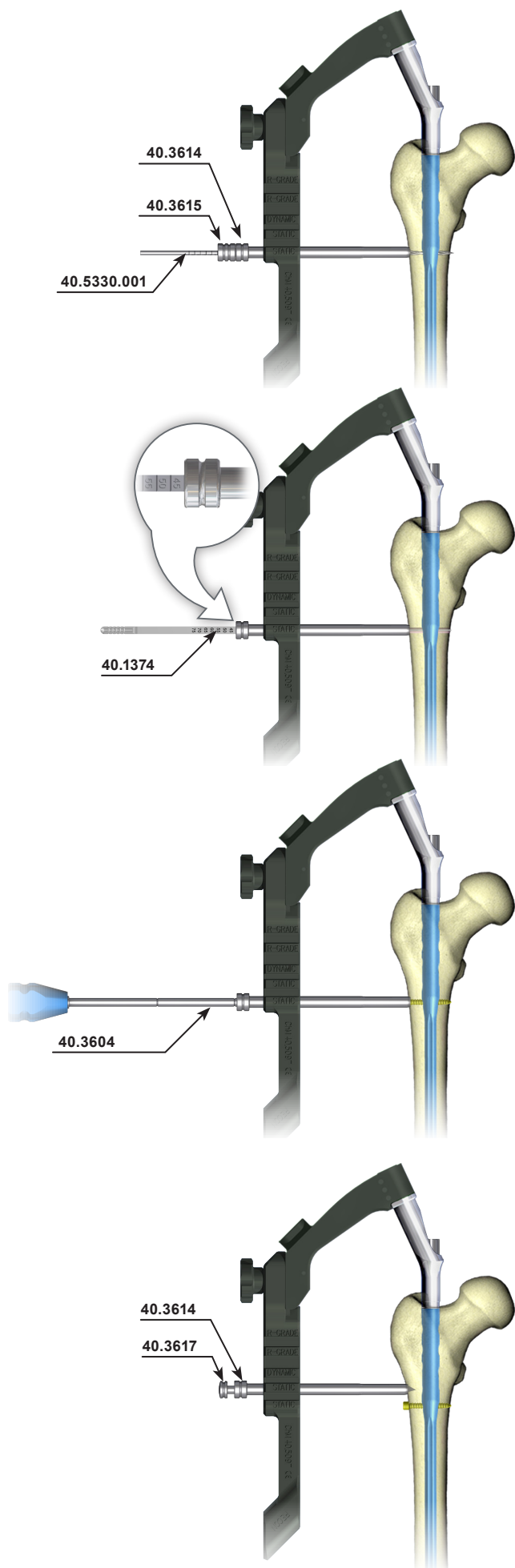

61 Insert the Drill Guide 6.5/3.5 [40.3615] (with two grooves) into the Protective Guide 9/6.5 [40.3614]. Mount the Drill With Scale 3.5/270 [40.5330.001] on the surgical drive and advance it through the Drill Guide. Drill the hole in the femur through its both cortex layers and the hole in the nail. The scale on the drill shows the length of the locking element.

Remove the Drill and Drill Guide.  
Leave the Protective Guide in the hole of the targeter.

62 Insert the Screw Length Measure [40.1374] through the Protective Guide 9/6.5 [40.3614] into the drilled hole until its hook reaches the "exit" plane of the hole. Read the length of the locking screw on the measure scale B-D. During the measurement the end of the Protective Guide should rest on the cortex.

Remove the Screw Length Measure.  
Leave the Protective Guide in the hole of the targeter.

63 Insert the tip of the Screwdriver S3.5 [40.3604] into the hexagonal socket of the selected locking screw. Then advance both into the Protective Guide. Insert the locking screw into the prepared hole until the head of the screw reaches the cortex of the bone (the groove on the screwdriver shaft matches the edge of the protective guide).

Remove the Screwdriver and Protective Guide.



**NOTE!** If the surgeon decides to lock the nail in the proximal part with two screws, insertion of the second screw should be performed as shown in steps [50] to [53]. Otherwise omit these steps.

64 Insert the Protective Guide 9/6.5 [40.3614] (with one groove on the handle) with the Trocar 6.5 [40.3617] into the proximal hole of the proximal targeter. Advance Trocar until it reaches cortex and mark the entry point for the drill. Advance the Protective Guide together with the trocar until it touches the bone.

Remove the Trocar.  
Leave the Protective Guide in the hole of the targeter.

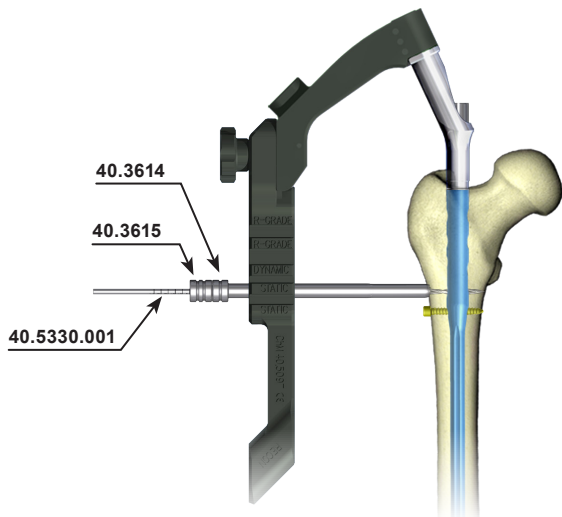

65 Insert the Drill Guide 6.5/3.5 [40.3615] (with two grooves) into the Protective Guide. Mount the Drill With Scale 3.5/270 [40.5330.001] on the surgical drive and advance it through the Drill Guide. Drill the hole in the femur through its both cortex layers and the nail hole. The scale on the Drill shows the length of the locking element.

Remove the Drill and the Drill Guide.  
Leave the Protective Guide in the hole of the targeter.

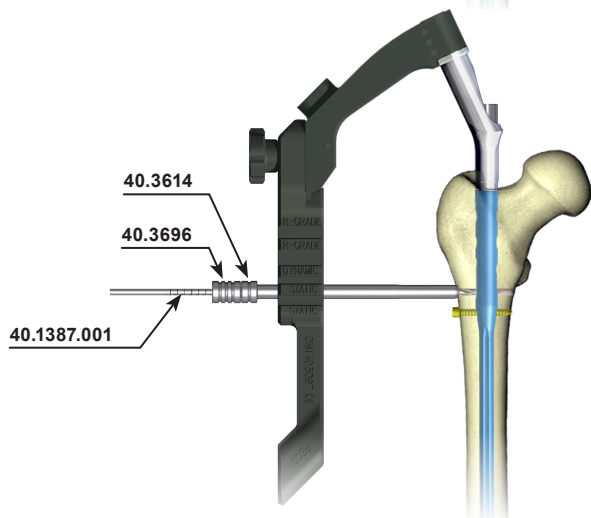

66 Insert the Drill Guide 6.5/4.5 [40.3696] into the Protective Guide. Mount the Drill 4.5/270 [40.1387.001] on the surgical drive and advance it through the Drill Guide. Drill the hole in the femur only through its first cortex up to the hole in the nail.

Remove the Drill and the Drill Guide.  
Leave the Protective Guide in the hole of the targeter.

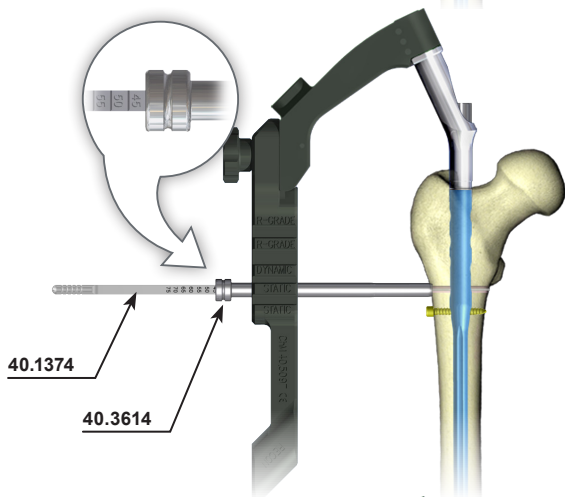

67 Insert the Screw Length Measure [40.1374] through the Protective Guide 9/6.5 [40.3614] into the drilled hole until its hook reaches the "exit" plane of the hole. Read the length of the locking screw on the scale B-D. During the measurement the end of the Protective Guide should rest on the cortex.

Remove the Screw Length Measure.  
Leave the Protective Guide in the hole of the targeter.

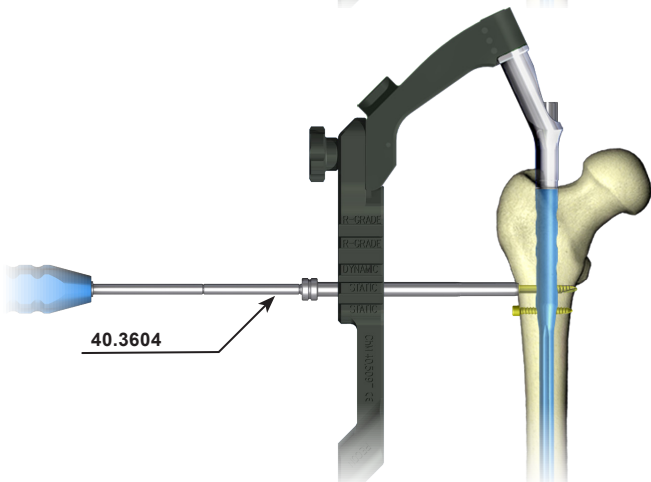

68 Insert the tip of the Screwdriver S3.5 [40.3604] into the hexagonal socket of the selected locking screw. Then advance both into the Protective Guide. Insert the locking screw in the prepared hole until the head of the screw reaches the cortex of the bone (the groove on the screwdriver shaft matches the edge of protective guide).

Remove the Screwdriver and the Protective Guide.

## IV.4.3. Targeter removal, End cap insertion

- 69 Using the Wrench S10 [40.5526.100] unscrew the Connecting Screw [40.5067] or [40.5069] from the nail shaft and dismount the Targeter from the nail locked in the medullary canal.

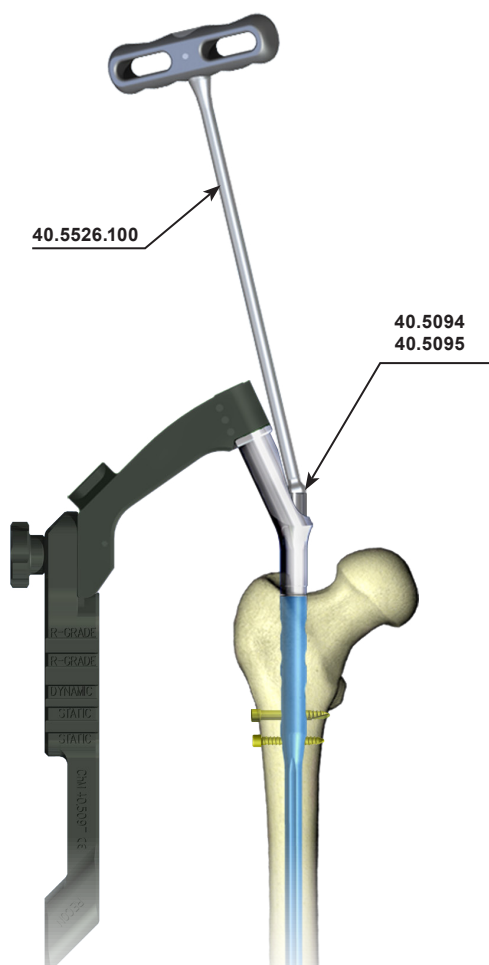

- 70 In order to secure the inner thread of the nail from bone ingrowth, using the Cannulated Screwdriver S5.0/2.2 [40.3675] insert:

- the End Cap [1.2104.3xx] or [3.2104.3xx] in the case of using the universal nail;
- the End Cap [1.2104.4xx] or [3.2104.4xx] in the case of using the compression nail.

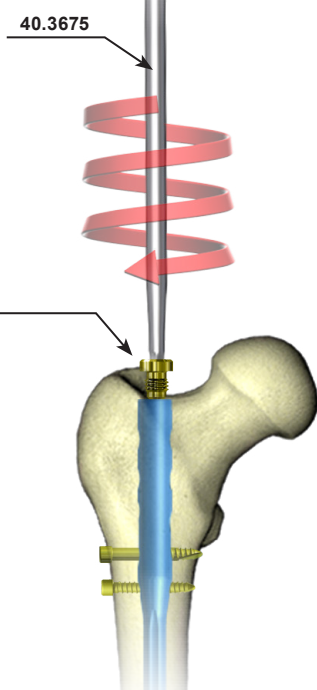

1.2104.3xx  
universal nail  
3.2104.3xx  
1.2104.4xx  
compression nail  
3.2104.4xxxx

## IV.5. STATIC METHOD WITH THE USE OF RECONSTRUCTION NAIL

### IV.5.1. Proximal nail locking

In the static method, the intramedullary reconstruction nails for fixation of femoral fragments may be used:

- right nail (*market RIGHT*) should be used for fixation of the left femur,
- left nail (*market LEFT*) should be used for fixation of the right femur.

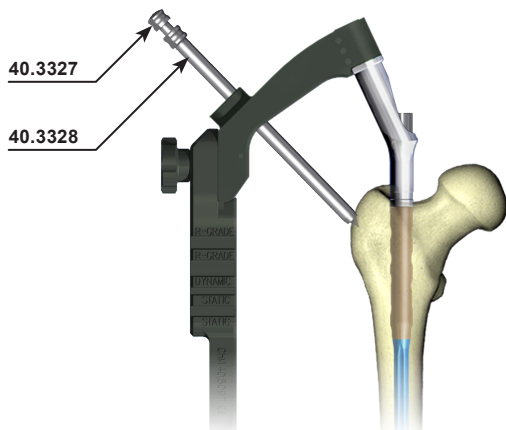

71 Insert the Protective Guide [40.3328] (*with one groove on the handle*) with the Trocar 9 [40.3327] into the hole in the Targeter arm [40.5091]. Mark the entry point for the locking screw and make an adequate incision of the soft tissues. Advance the Trocar until it reaches the cortex bone and mark the entry point for the drill. Advance the Protective Guide together with the Trocar until it touches the bone.

Remove the Trocar.  
Leave the Protective Guide in the hole of the targeter.

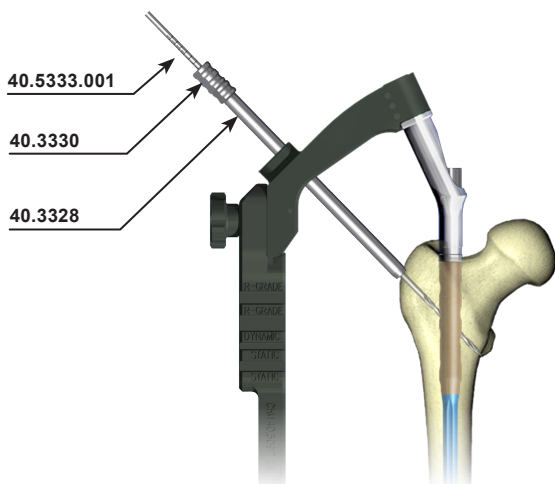

72 Insert the Drill Guide 9/4.5 [40.3330] (*with two grooves*) into the protective guide. Mount the Drill With Scale 4.5/370 [40.5333.001] on the surgical drive and advance it through the drill guide. Drill the hole in the femur through its both cortex layers and the hole in the nail. The scale on the drill shows the length of the locking element.

Remove the Drill and the Drill Guide.  
Leave the Protective Guide in the hole of the targeter.

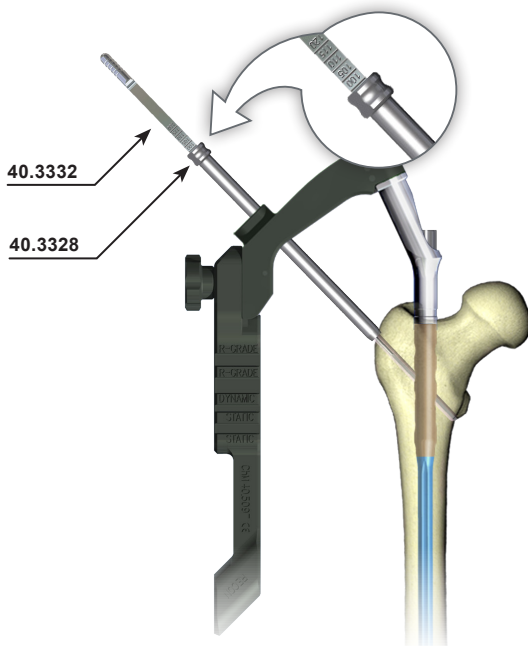

73 Insert the Reconstruction Screw Length Measure [40.3332] through the Protective Guide into the drilled hole until its hook reaches the "exit" plane of the hole. Read the length of the reconstructive screw on the measure scale. During the measurement the end of the Protective Guide should rest on the cortex bone.

Remove the Screw Length Measure.  
Leave the Protective Guide in the hole of the targeter.

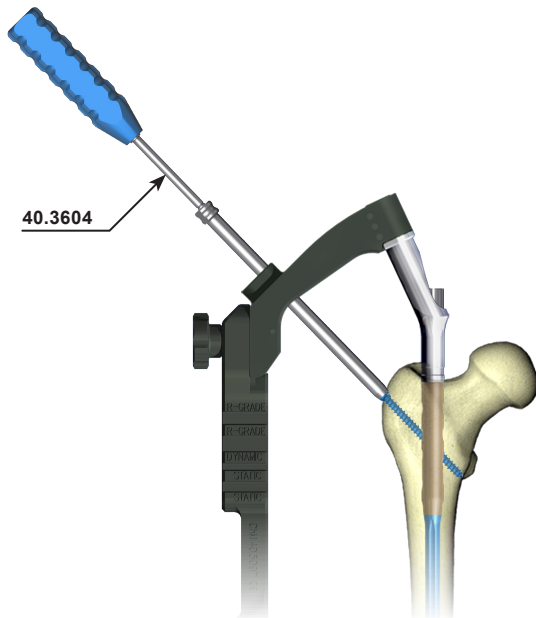

- 74 Insert the tip of the Screwdriver S3.5 [40.3604] into the hexagonal socket of the selected locking screw.

For locking use the screw with 6.5mm diameter and length determined in previous step. Then advance both into the Protective Guide. Insert the reconstructive screw in the prepared hole until the head of the screw reaches the cortex of the bone (*the groove on the screwdriver shaft matches the edge of protective Guide*).

Remove the Screwdriver S3.5 and Protective Guide.

#### IV.5.2. Distal nail locking

Prior to distal locking of the nail, do the following:

1. Mount the Distal targeter D [40.5093] to the targeter arm [40.5091] and secure it with the collar bolt. *If properly installed, the signs RIGHT or LEFT on both targeters should comply.*

2. Verify, using the X-Ray device, the position of nail holes and in distal targeters holes. The centers of the holes in the nail and in distal targeters have to be in line.

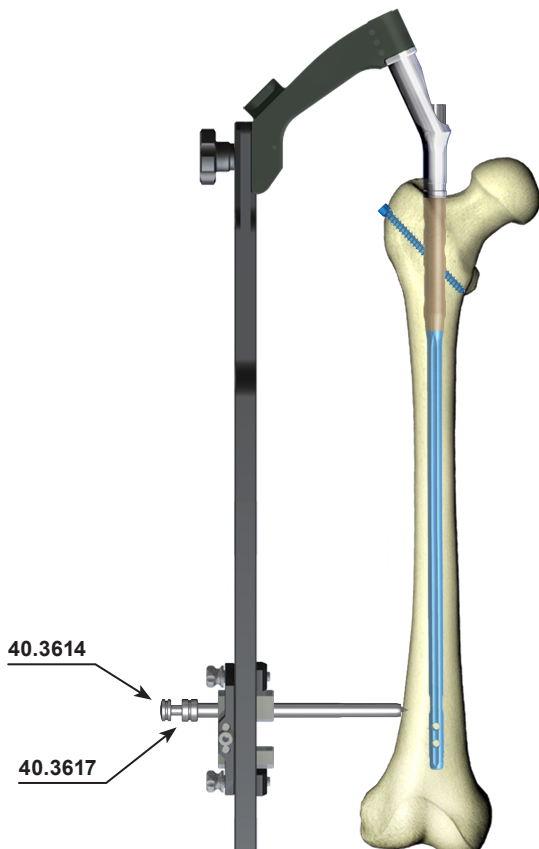

- 75 Insert the Protective Guide 9/6.5 [40.3614] (*with one groove on the handle*) with the Trocar 6.5 [40.3617] into the hole in the distal targeter. Mark on the skin the entry point for the locking screw and make adequate incision through the soft tissues. Advance the Trocar until it reaches cortex and mark the entry point for the drill. Advance the Protective Guide together with the Trocar until it touches the cortex.

Remove the Trocar.

Leave the Protective Guide in the hole of the targeter.



**NOTE!** For the rest of the procedure follow the subchapter IV.2.2 of these instructions.

IV.5.3. Targeter removal, End cap insertion

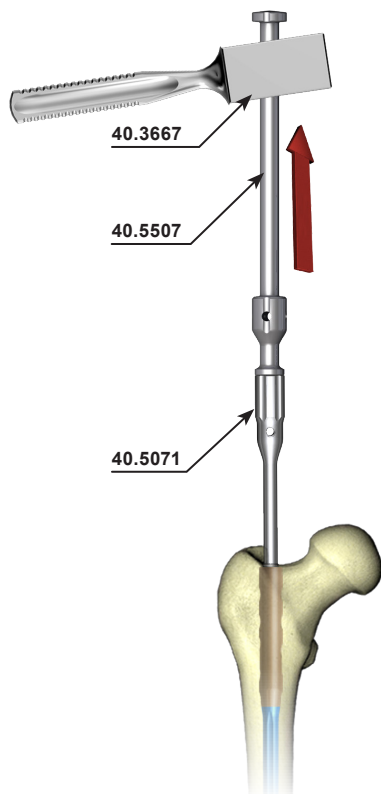
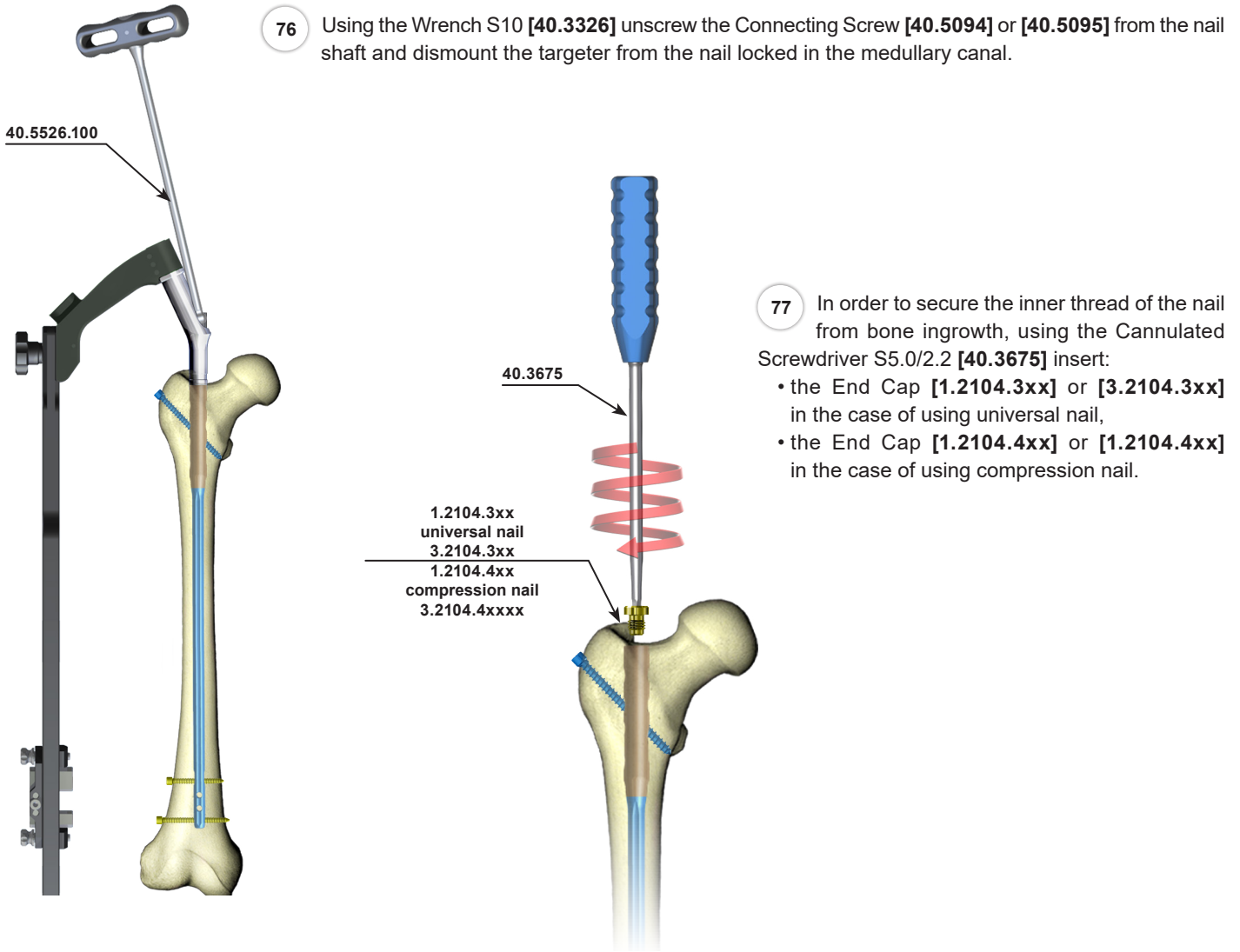

IV.6. NAIL REMOVAL

78 Use the Cannulated Screwdriver S5.0/2.2 [40.3675] to remove the End Cap or Screwdriver S3.5 [40.4604] to remove compression screw from the nail shaft. Insert the Connector [40.5071] into the threaded nail hole. Using the Screwdriver S3.5 [40.3604] unscrew all the locking screws. Attach the Impactor-Extractor [40.5507] to the connector and with the help of the Mallet [40.3667] extract the nail from the medullary canal.



#### IV.7.2. Introduction

Retrograde nailing of the femur provides fixation in the cases of fractures above the knee joint (*up to 20cm from distal end of femur*) or multi-fragment fractures of condyle. The retrograde nail may also be used when a hip prosthesis or another implant has already been implanted in proximal femur.

**CHARFIX** system provides the retrograde nails with diameters 10, 11 or 12mm and length between 160 and 440 mm. To lock the nail distally (*by the knee joint*) depending on the fracture type use:

- two locking screws 6.5mm,
- two locking sets.

There are five sizes of locking sets:

- 50, with range between 50 and 65 mm,
- 60, with range between 60 and 75 mm,
- 70, with range between 70 and 85 mm,
- 80, with range between 80 and 95 mm,
- 90, with range between 90 and 105 mm.

Locking set consists of: bolt, two washers and a locking screw. Locking screws are used to lock the nail proximally. The nail features anatomical shape of the femur - its distal end is 5° angled.

Each surgical procedure has to be planned. Before the operation adequate X-Ray images have to be taken in order to examine the type of fracture and assess the dimensions of implant (*diameter and length*). The operation should be performed on the patient in supine position, with tourniquet on and the knee joint bent at 90°.

Nailing may be performed with or without reaming of medullary canal. In both cases the diameter of medullary canal ought to be bigger than the diameter of used nail; if canal is reamed its final diameter should be 1.5 to 2mm wider than the diameter of the nail. In both cases the canal has to be additionally reamed in distal part (*entry point*) with a 13.0 reamer at the distance of first 6cm (*diameter of the nail in distal end is 12mm*).





The following paragraphs describe the most important steps during implantation of intramedullary interlocking femoral nails; nevertheless, these are not detailed instructions for use. The surgeon decides about choosing the surgical technique and its application in each individual case.

On the basis of X-Ray image taken of fractured femur and of the healthy one, the surgeon decides about the length and diameter of the nail.

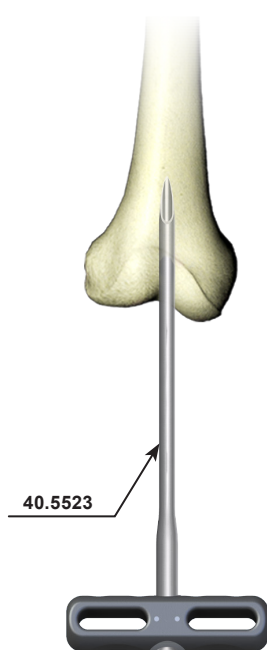

- 1 Make the incision over the middle of patellar ligament or more paracentrally. Expose intercondylar region (*split the fibers of ligament or move it laterally*). Use the Curved Awl 8.0 [40.5523] to open the medullary canal to the depth of about 6 cm.



Control the procedure with the X-Ray imaging.

- 2 After opening the medullary canal, insert the Guide Rod 3.0/580 [40.3925] with mounted Guide rod handle [40.1351] until an adequate depth is reached.

Remove the Guide rod handle [40.1351].  
Remove the Awl [40.5523].



- 3 In the case medullary canal is reamed, gradually increase the diameter of the canal with steps of 0.5 mm, until the diameter 1.5 to 2.0 mm wider than the diameter of the femoral nail is reached, for the depth at least equal to the nail length (*but not lesser*).

In both cases, when the medullary canal was reamed or not, the canal should be drilled using 13mm reamer to the depth of approx. 6 cm

Remove the Flexible Reamer.





**NOTE!** Steps [4] and [5] are applicable only if the medullary canal has been reamed or if another reamer guide has been used. Otherwise go directly to the step [6]. In the case the canal has not been reamed, in step [3] ream the distal part of the canal using the reamer of 13mm in diameter for the depth of about 6cm and then proceed directly to step [6].

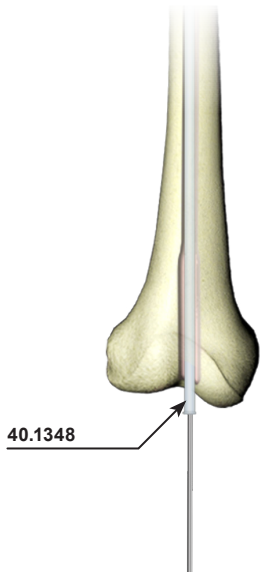

- 4 Insert the Teflon Pipe Guide [40.1348] onto the flexible reamer guide in the medullary canal.

Remove the Reamer Guide.

- 5 Mount the Guide rod handle [40.1351] on the Guide Rod [40.3925.580] and advance the rod into the Teflon Pipe Guide until its tip reaches the proximal epiphysis.

Remove the Guide rod handle [40.1351] from the Guide Rod.  
Remove the Teflon Pipe Guide [40.1348].

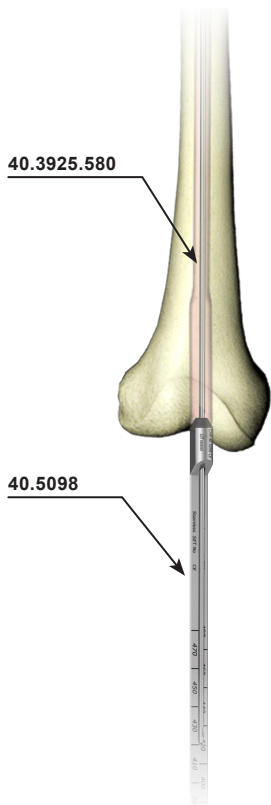
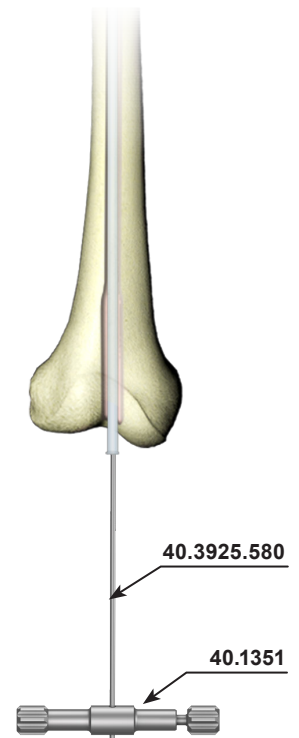

- 6 Insert the Nail Length Measure [40.5098] on the Guide Rod until it rests on bone. Read the length of the nail on the nail measure scale. Remove the Nail Length Measure from the guide rod. In the case of using solid nail, remove the Guide Rod from medullary canal. Medullary canal is ready for nail insertion.

IV.7.3. Nail assembling to the targeter, nail insertion into the medullary canal

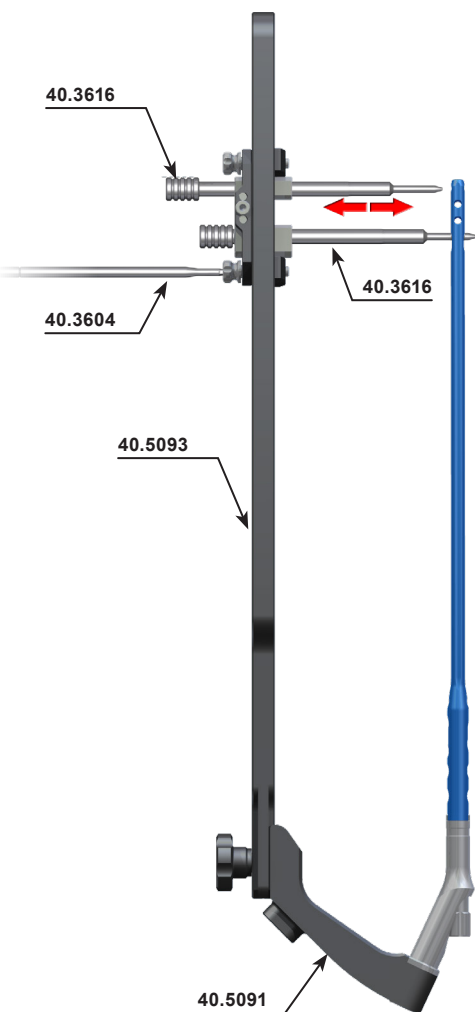

- 7 Mount the Distal targeter D [40.5093] on the Targeter arm [40.5091] using collar bolt (included in distal targeter).



**NOTE!** When operating right limb, the targeter should be mounted so the **RIGHT** signs on both sides are in line. In the case of left limb - the **LEFT** signs on both sides shall be in line.

Use the Wrench S10 [40.5526.100] to mount the intramedullary nail on the distal targeter with the Connecting Screw M10x1 L=55 [40.5094]. With a pair of the Set Blocks 9/4.5 [40.3616] place the slider of distal targeter in line with distal locking holes of intramedullary nail. Secure the slider of the targeter using the Screwdriver S3.5 [40.3604].



**CHECK!** Properly set and secured slider means that set blocks smoothly hit the holes in the nail.

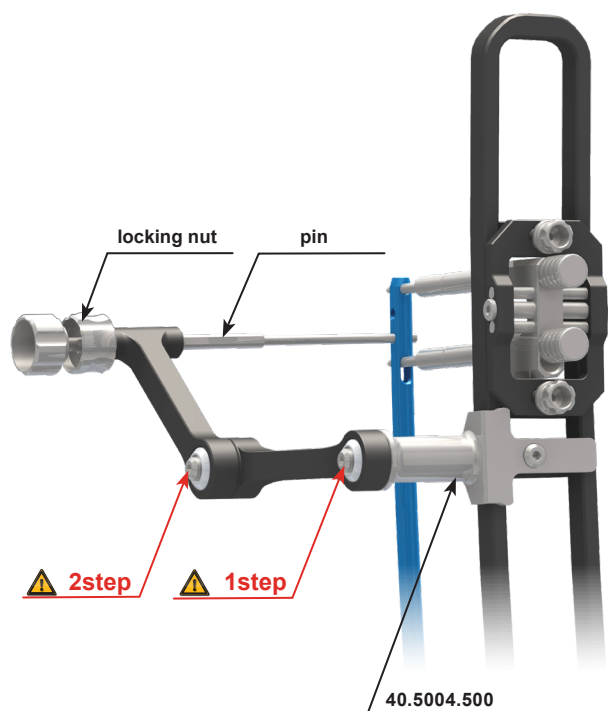

8

- I. Attach Angular set block [40.5004.500] to the Targeter D this way it rests its body on the slider of the distal targeter. Screw maximally locking nut in hole of angular set block.
- II. Insert the Pin in the locking nut. Using Screwdriver S3.5 [40.3604] loosen the screws locking the arms of the angular set block and set them this way the end of the Pin inserted in the hole of the Angular set block nut touches the nail in the transverse hole of the medullary nail. In this position lock the arms of angular set block using the Screwdriver S3.5 [40.3604].



**Firstly, tightening the locking screw in the column of the set block, lock the indirect arm (1 step). Next, lock the arm with the set block (2 step).**

- III. Remove the pin from the Angular set block nut.

9

- I. Loosen the screw mounting the Angular targeter to the targeter D and move it by 10-15 mm. Lock the Angular targeter in the new setting using the Screwdriver S3.5 **[40.3604]**.
- II. Insert the Pin in the hole of the locking nut so that its end leans against the nail. Using the Screw and the Screwdriver S3.5 **[40.3604]** lock the pin in the nut.
- III. Unscrew the locked pin-nut set from the Angular set block. Dismount the distal targeter from the targeter arm.

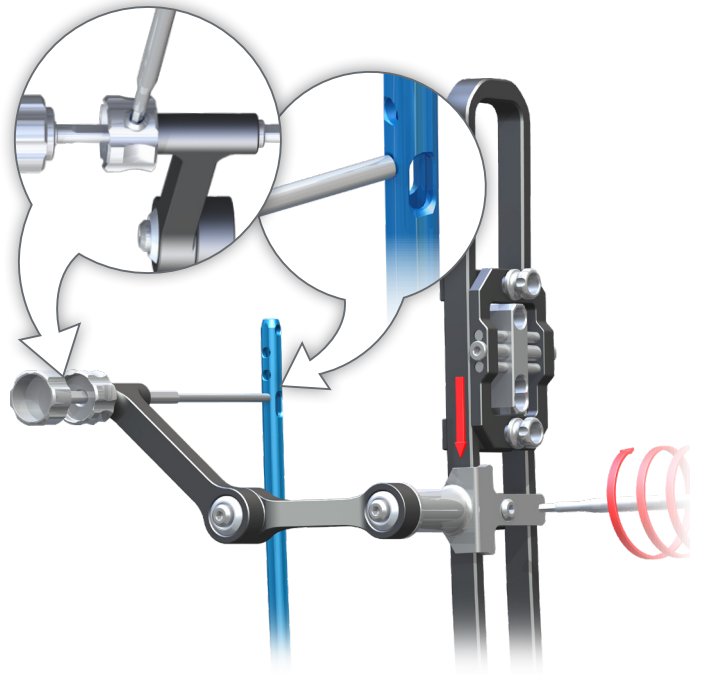

- 10 Mount the Impactor-Extractor **[40.5507]** to the Targeter arm **[40.5091]** with fixed nail. Insert the nail onto the Guide Rod **[40.3925.580]** in medullary canal. Advance the nail by pushing and maneuvering it until it reaches adequate depth.

Remove the Guide Rod **[40.3925.580]**.  
Dismount the Impactor-Extractor **[40.5507]** from the Targeter arm.

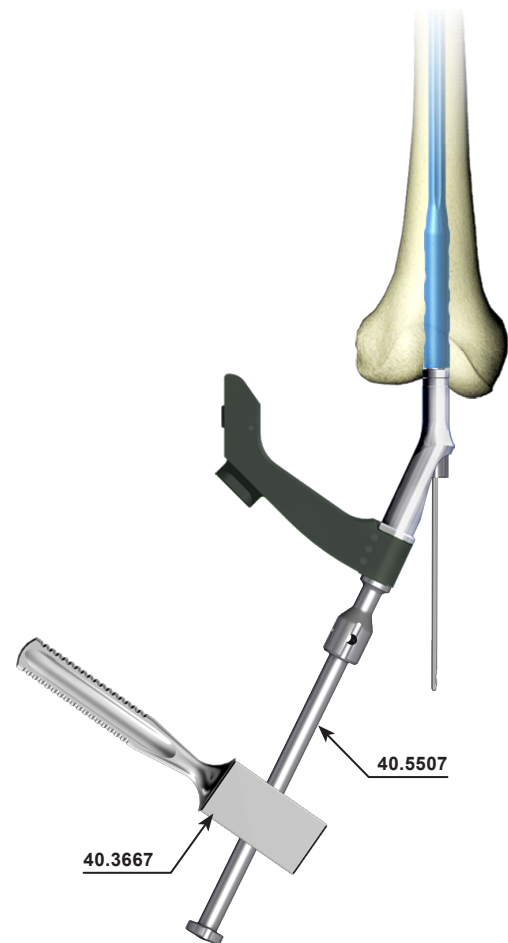

## IV.7.4. Locking the nail in the condylar femur

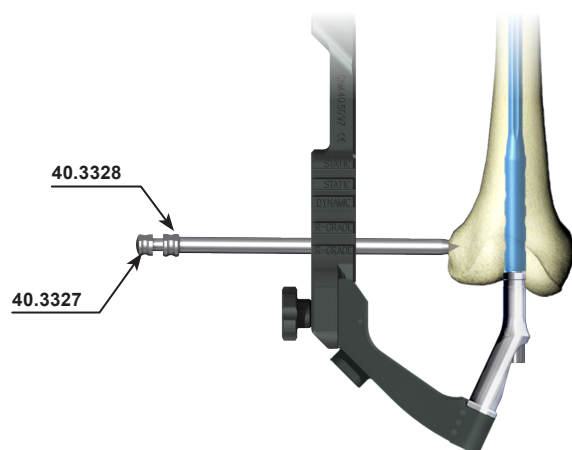

- 11 Mount the Targeter [40.5097] on the Targeter arm [40.5091]. Insert the Protective Guides [40.3328] and the Trocar 6.5 [40.3327] into targeter hole positioned in the most distal part. Mark the entry point and make an adequate incision of the soft tissues. Advance the trochar with protective guides until they reaches the cortex bone. Mark with the trochar the entry point for the drill.

Remove the Trocar.  
Leave the Protective Guides in the hole of the targeter.

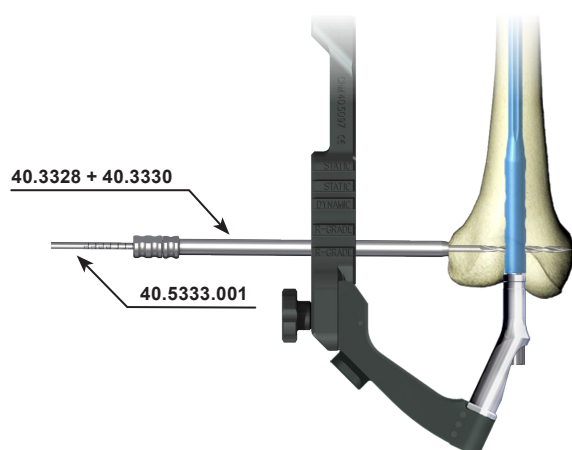
IV.4.0.A. **OPTION I: Locking with screws**

- 12 Insert the Drill Guide 6.5/4.5 [40.3330] into the Protective Guide [40.3328]. Mount the Drill With Scale 4.5/370 [40.5333.001] on the surgical drive and advance it through the drill guide. Drill the hole for locking screw. The scale on the drill shows the length of the locking element. Control drilling process with X-Ray imaging.

Remove the Drill and drill guide.  
Leave the Protective Guide in the hole of the targeter.

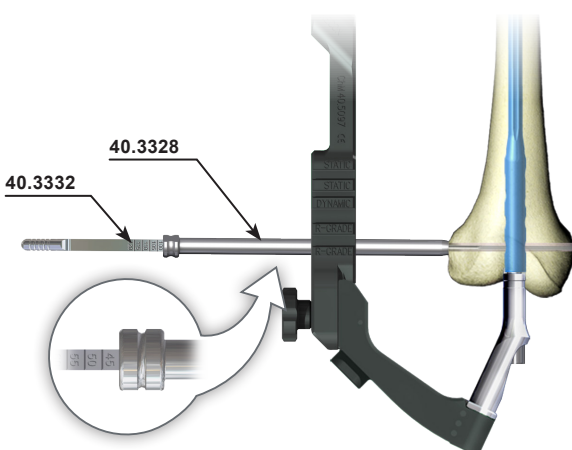

- 13 Insert the Screw Length Measure [40.3332] through the Protective Guide [40.3328] into the drilled hole until its hook reaches the "exit" plane of the bone. Read the length of the locking screw on the measure scale. During the measurement the Protective Guide should rest on the cortex bone.

Remove the Screw Length Measure.  
Leave the Protective Guide in the hole of the targeter.

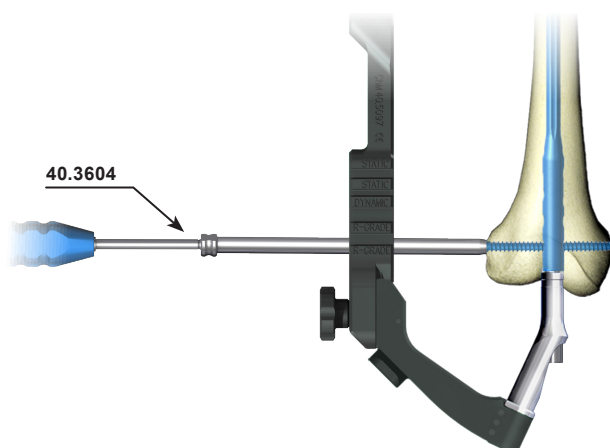

- 14 Insert the tip of the Screwdriver S3.5 [40.3604] into the hexagonal socket of the selected locking screw. Then advance both into the Protective Guide. Insert the locking screw in the prepared hole until the head of the screw reaches the cortex bone (the groove on the screwdriver shaft matches the edge of protective guide).

Remove the Screwdriver and the Protective Guide.  
For distal locking of the nail use locking screws with diameter 6.5mm

IV.4.0.B. **OPTION II: Locking with locking set (bolt - two washers - locking screw)**

15 The Drill Guide [40.3329] and the Protective Guide [40.3328] are in the hole of the targeter. Mount the Drill 6.5/370 [40.2068.371] on the surgical drive and advance it through the Drill Guide. Drill the hole through the bone.



**Control drilling with X-Rays image intensifier.**

With the help of X-Ray image intensifier make incision of the soft tissues over the exit point of the drill. Remove the Drill. Leave the Protective Guide [40.3328] in the targeter.

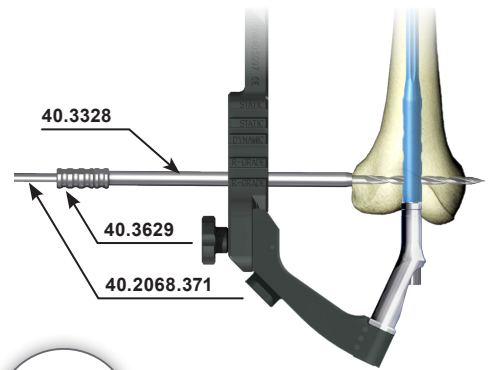

16 Insert the the Screw Length Measure [40.3332] through the Protective Guide into the drilled hole until its hook reaches the “exit” plane of the hole. Deduct 10mm from the reading on the measure scale, to get characteristics of the locking set required.

**Select locking set with adequate range, e.g. with reading “75” the characteristics amount to “65”, therefore locking set 60 with range between 60 and 75 mm is adequate. During the measurement the protective guide should rest on the cortex bone.**

Remove the screw length measure. Leave the protective guide in the hole of the targeter.

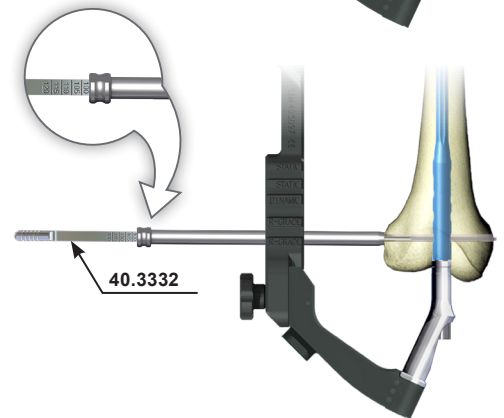

17 Insert the Bolt Guide [40.5075] into the protective guide. The pilot which is integral part of the the Bolt Guide [40.5075], should be attached on the Bolt Guide. Advance the Bolt Guide through the drilled hole until its tip reaches the hole from the other side. Remove the pilot from the the Bolt Guide. Put the bolt (*implant*) through the washer (*implant*) and screw it in onto the the Bolt Guide using the Screwdriver S3.5 [40.5074]. Advance the bolt into the hole in the bone (*head of the bolt should rest on the cortex with the washer between them*).

Unscrew the Bolt Guide from the bolt and remove it from the Protective Guide.

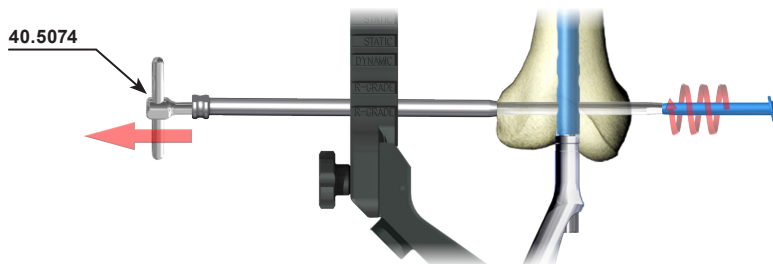

18 Leave the Protective Guide [40.3328] in the hole of the targeter. Insert the tip of the Screwdriver S3.5 [40.3604] into the hexagonal socket of the locking screw (*implant*) and advance both into the Protective Guide. Put the washer (*implant*) over the locking screw when it leaves the protective guide and enters the hole in the bone. Insert the locking screw in the threaded hole of the bolt (*hold the bolt with the screwdriver*).

Two screwdrivers are used to secure the locking set (*locking screw, two washers, bolt*). Remove the screwdrivers and protective guide.

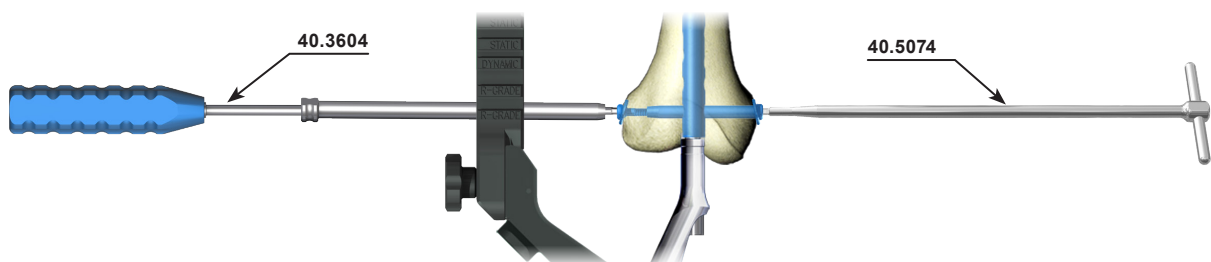

**NOTE!** To secure second locking set for the other distal hole, follow the steps [15] to [18].

#### IV.7.5. Locking the nail in the femoral shaft

Prior to distal locking of the nail, do the following:

1. Mount the Distal targeter D [40.5093] to the targeter arm [40.5091] and secure it with the collar bolt.  
If properly installed, the signs *RIGHT* or *LEFT* on both targeters should comply.

2. Verify, using the X-Ray device, the position of nail holes and in distal targeters holes. The centers of the holes in the nail and in distal targeters have to be in line.

19 Insert the Protective guide [40.3614] and the Trocar [40.3617] in the hole of the Angular set block. Mark the entry point and make an adequate incision of the soft tissues. Advance the trocar with protective guides until they reach the cortex bone. Mark with the trocar the entry point for the drill.

Remove the Trocar.

Leave the Protective guide in the hole of the Angular set block.

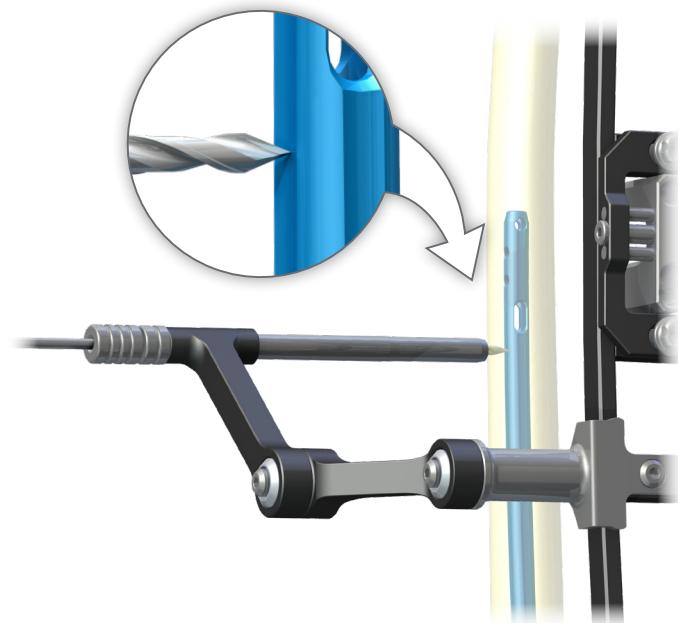
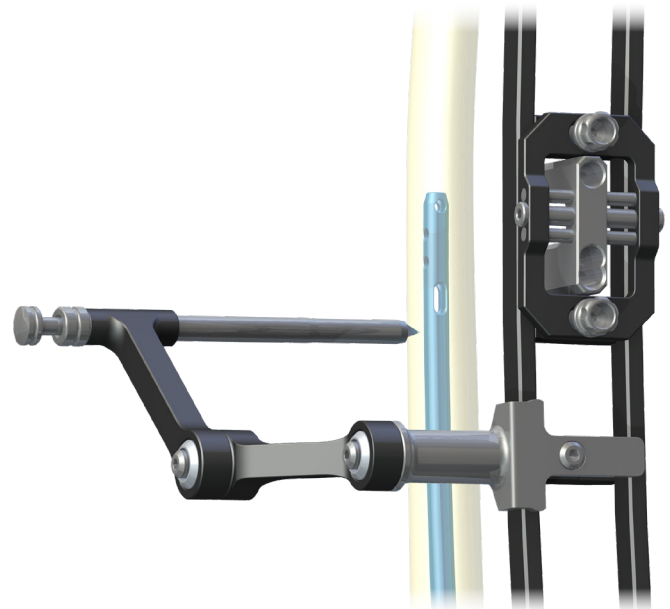

20 Insert the Drill Guide 3.5 [40.3615] into the Protective Guide [40.3614]. Mount the Drill 3.5/270 [40.1386] on the surgical drive and advance it through the drill guide. Under image intensifier control drill the hole until reaching the nail. Remove the Drill and Drill guide and the Protective guide.

21 Screw maximally in the pin and the nut in the hole of the Angular set block. Proceed with locking the nail from the slider of the Distal targeter.

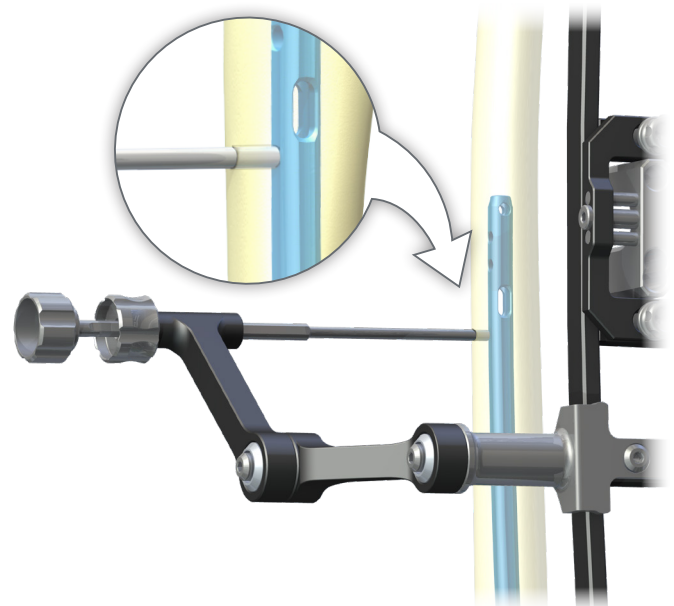

- 22 Insert the Protective Guide 9/6.5 [40.3614] with the Trocar 6.5 [40.3617] into the distal hole in the Distal targeter D [40.5093]. Mark the entry point, make an adequate incision of the soft tissues. Advance the trocar together with protective guide until it reaches the cortex bone. Using Trocar mark the entry point for locking screw.

Remove the trocar.  
Leave the Protective Guide in the hole of the targeter.

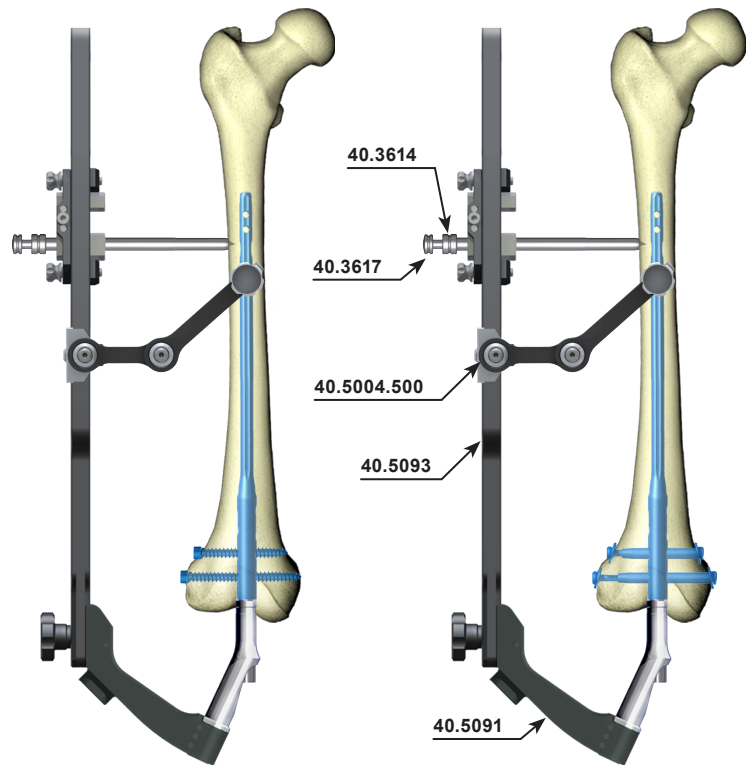

- 23 Insert the Drill Guide 6.5/3.5 [40.3615] (with two grooves) into the Protective Guide 9/6.5 [40.3614] left in the hole of the targeter. Mount the Drill With Scale 3.5/270 [40.5330.001] on the surgical drive and advance it through the drill guide. Drill the hole in the femoral shaft through its both cortex layers and the nail hole. The scale on the drill shows the length of the locking element. Disconnect the drive from the drill and leave in place system: the protective guide - drill guide - drill.

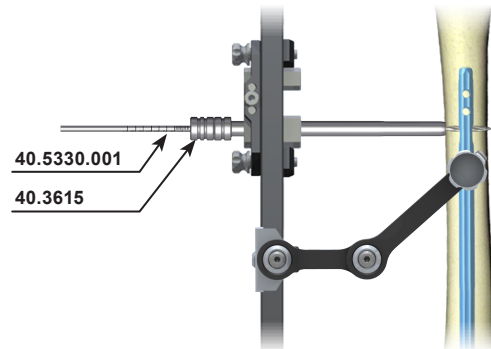

- 24 Insert the Protective Guide 9/6.5 [40.3614] (with one groove) with the Trocar 6.5 [40.3617] into the second hole of the targeter. Advance the trocar until it reaches the cortex bone and mark the entry point for the drill. Advance the Protective Guide together with the Trocar until it touches the bone.

Remove the Trocar.  
Leave the Protective Guide in the hole of the targeter.

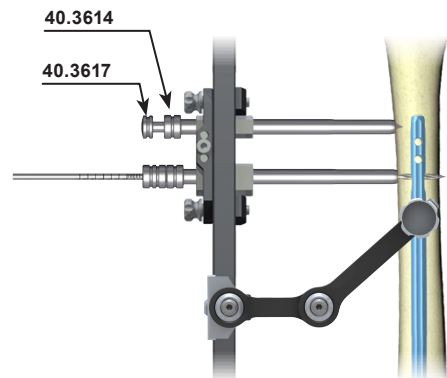



40.3615

40.5330.001

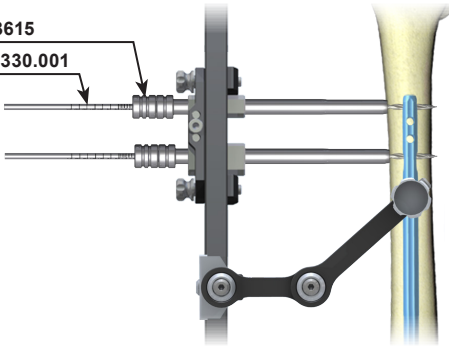

- 25 Insert the Drill Guide 6.5/3.5 [40.3615] (with two grooves) into the Protective Guide 9/6.5 [40.3614]. Mount the Drill With Scale 3.5/270 [40.5330.001] on the surgical drive and advance it through the drill guide. Drill the hole in the femoral shaft through its both cortex layers and the nail hole. The scale on the drill shows the length of the locking element.

Remove the Drill and Drill Guide.

Leave the Protective Guide in the hole of the targeter.

40.1374

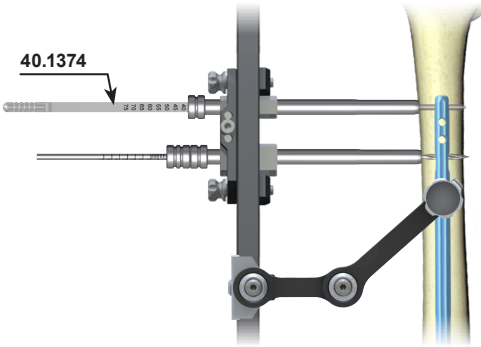

- 26 Insert the Screw Length Measure [40.1374] through the Protective Guide 9/6.5 [40.3614] into the drilled hole until its hook reaches the "exit" plane of the hole. Read the length of the locking screw on the B-D scale. During the measurement the Protective Guide should rest on the cortex bone.

Remove the Screw Length Measure.

Leave the Protective Guide in the hole of the targeter

40.3604

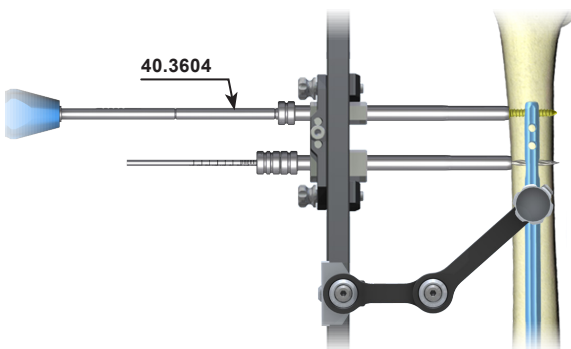

- 27 Insert the tip of the Screwdriver S3.5 [40.3604] into the hexagonal socket of the selected locking screw. Then advance both into the Protective Guide. Insert the locking screw in the prepared hole until the head of the screw reaches the cortex of the bone (*the groove on the screwdriver shaft matches the edge of protective guide*).

Remove the Screwdriver.

Leave the Protective Guide in place.

40.1374

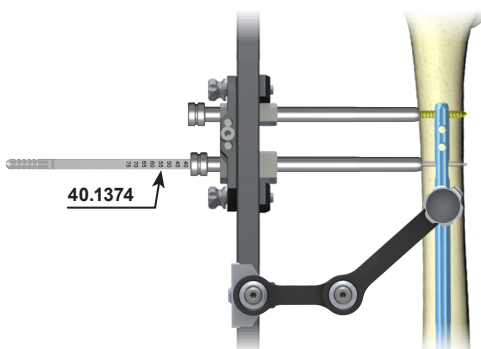

- 28 Remove the drill and drill guide from the proximal hole in the targeter. Leave the Protective Guide in the hole of the slider. Insert the Screw Length Measure [40.1374] through the Protective Guide into the drilled hole until its hook reaches the "exit" plane of the hole. Read the length of the locking screw on the B-D scale. During the measurement the Protective Guide should rest on the cortex bone.

Remove the Screw Length Measure.

Leave the Protective Guide in the hole of the targeter.

40.3604

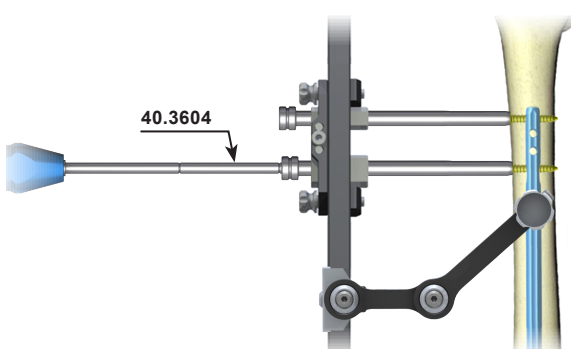

- 29 Insert the tip of the Screwdriver [40.3604] into the hexagonal socket of the selected locking screw. Then advance both into the Protective Guide. Insert the locking screw in the prepared hole until the head of the screw reaches the cortex of the bone (*the groove on the screwdriver shaft matches the edge of protective guide*).

Remove the Screwdriver.

30 After locking the nail in its distal part, remove only one of protective guides via which locking screws in the AP plane were inserted and proceed to locking the nail in the second plane. Unscrew the pin together with the nut from the angular set block. Move the angular set block [40.5004.500] so that it leans against the slider of the distal targeter. Lock the angular set block.

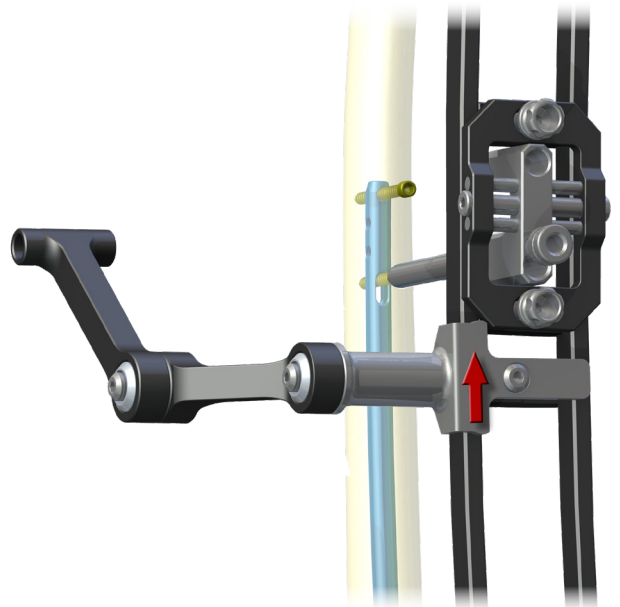

31 Insert Protective guide [40.3614] with Trocar [40.3617] into the hole of the angular set block. Mark the entry point and make an adequate incision of soft tissues. Advance the Trocar until it reaches the cortex bone and mark the entry point for the drill. Advance the Protective Guide together with the Trocar until it touches the bone.

Remove the Trocar.  
Leave the Protective guide in the hole of the Angular set block.

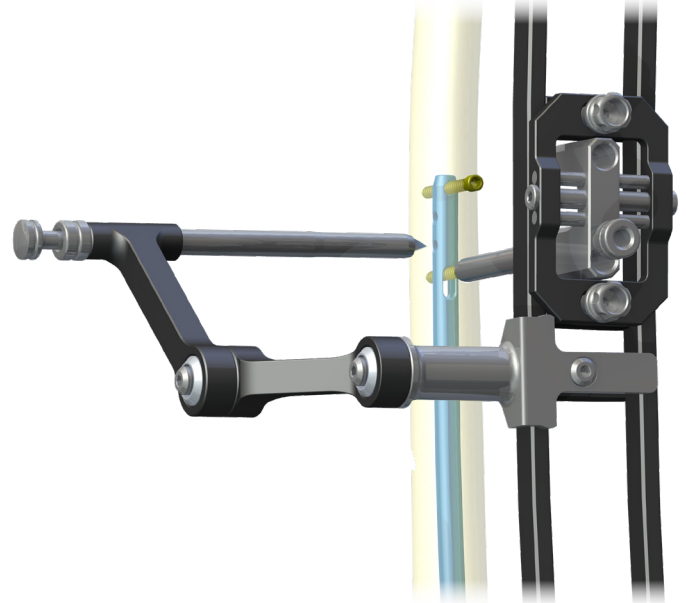

32 Insert Drill guide [40.3615] into Protective guide. Using surgical drive and the Drill 3.5/270mm [40.1386] via drill guide drill the hole through both cortex layers of the bone and the nail hole. Verify the hole under image intensifier control.

Remove the drill.

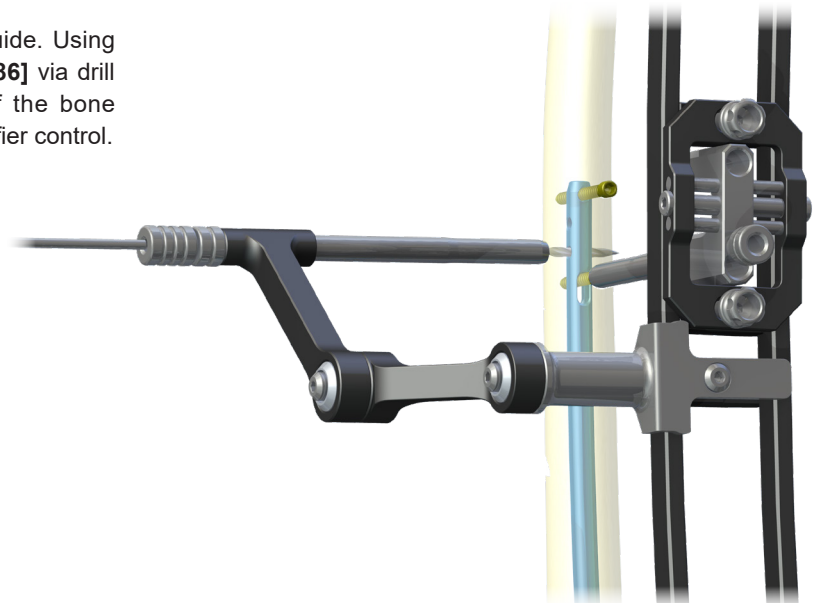

- 33 Insert the Screw Length Measure [40.1374] through the Protective Guide into the drilled hole until its hook reaches the outer side of the second cortex layer. Read the length of the locking screw on the B-D measure scale. During the measurement, the tip of Protective Guide should rest on the cortex bone.

Remove the Screw Length Measure.

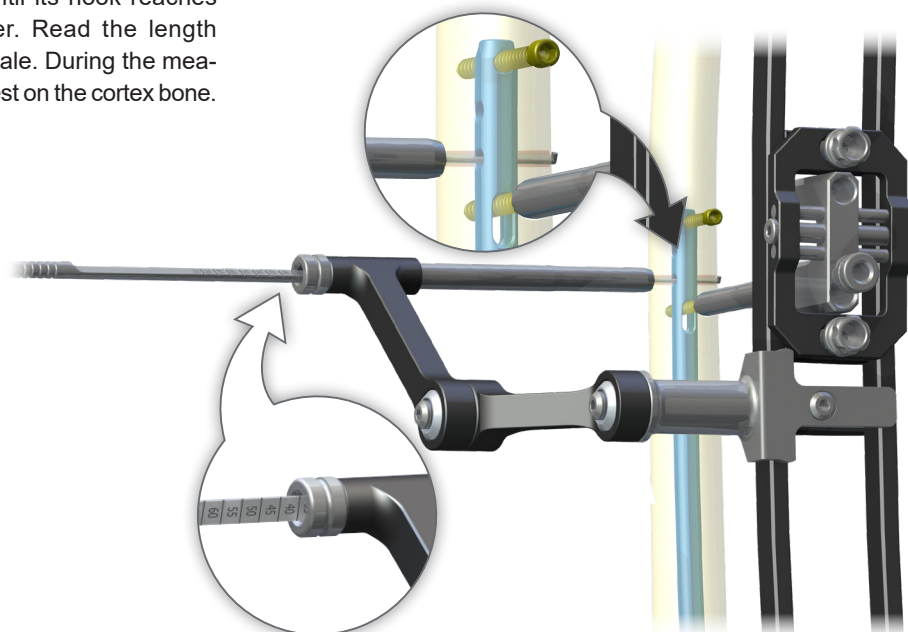

- 34 Insert the tip of the Screwdriver S3.5 [40.3604] into the hexagonal socket of the selected locking screw. Then advance both into the Protective Guide. Insert the locking screw, into prepared hole until the head of the screw reaches the cortex bone (*the groove on the screwdriver shaft matches the edge of the protective guide*).

Remove the Screwdriver and Protective Guide.

Dismount the Angular set block and proceed to proximal nail locking.

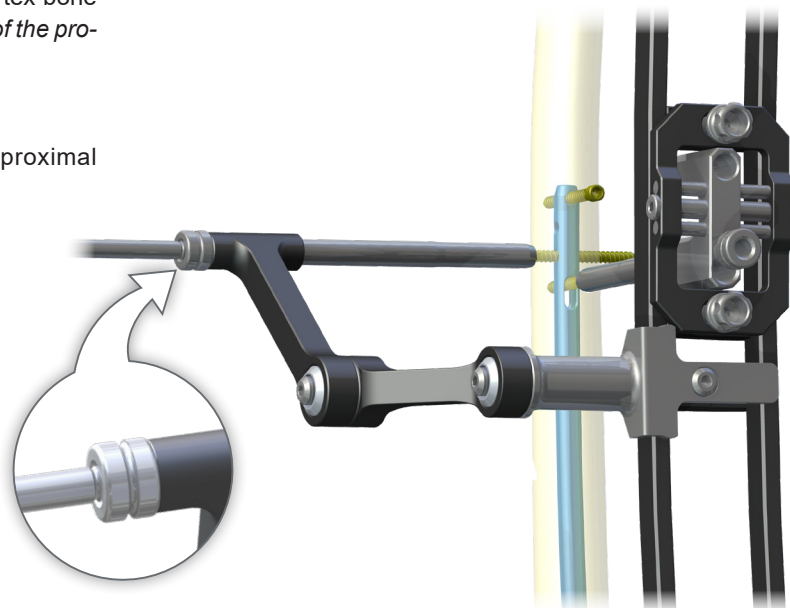

**NOTE:** Locking of the nail in its proximal part may also be performed using "free hand" technique. If applicable, refer to the description of the reconstruction method - steps from 35 to 38 of these instructions.

IV.7.6. Targeter removal and End cap insertion

35 Using the Wrench S10 [40.5526.100] unscrew the Connecting Screw M10x1 L=55 [40.5094] from the nail shaft and dismount the targeter from the nail locked in the medullary canal.

Dismount the targeter.

36 In order to secure the inner thread of the nail from bone ingrowth, using the Screwdriver [40.3604] insert the End Cap [1.2104.002] or [3.2104.002] (implant) inside the nail.

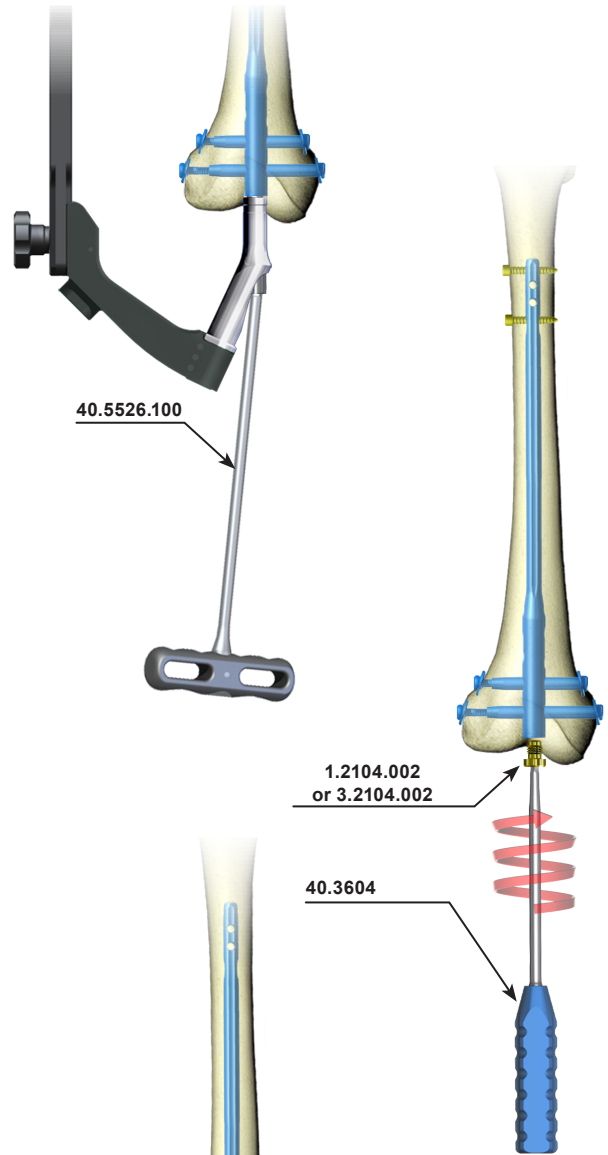

IV.7.7. Nail extraction

37 Use the Screwdriver S3.5 [40.3604] to remove the End Cap from the nail shaft. Using the Screwdriver S3.5 [40.3604] unscrew all the locking screws (use 2 screwdrivers to remove locking set). Using the wrench insert the Connector [40.5071] into the threaded hole of the nail. Attach the Impactor-Extractor [40.5507] to the connector and using the Mallet [40.3667] extract the nail from the medullary canal.

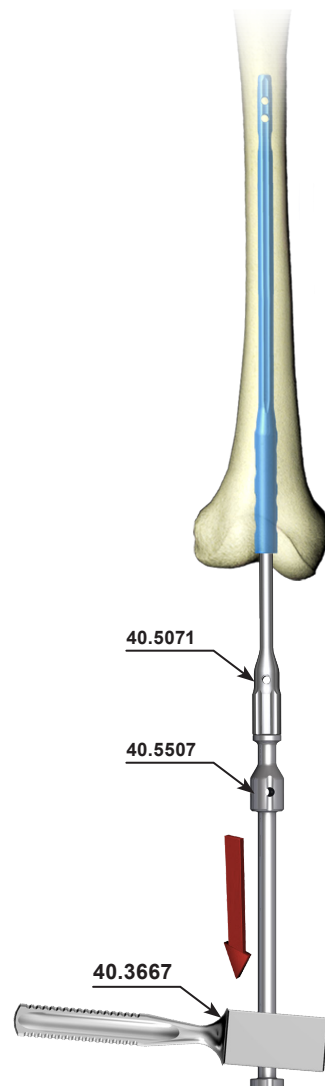



**ChM sp. z o.o.**

Lewickie 3b  
16-061 Juchnowiec Kościelny  
Polska

tel. +48 85 86 86 100

fax +48 85 86 86 101

chm@chm.eu

www.chm.eu



CE 0197