

CHM[®]

CHARSPINE *system 2*

ALIF PEEK INTERVERTEBRAL LOCKING CAGES

- *IMPLANTS*
- *INSTRUMENT SET 40.5830.000*
- *SURGICAL TECHNIQUE*

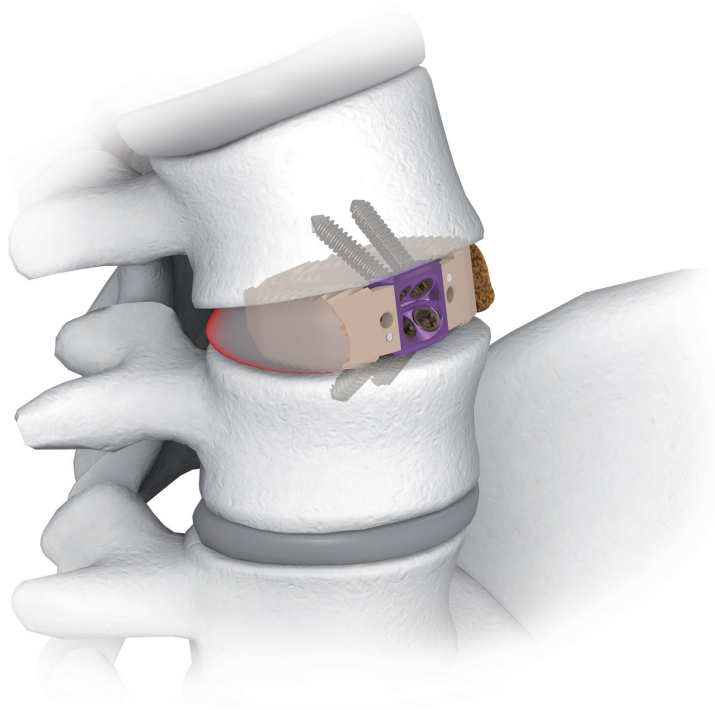

SYMBOLS DESCRIPTION



Caution - pay attention to a special procedure.



Perform the activity under X-Ray control.



Information about the next stages of a procedure.



Proceed to the next stage.



Return to the specified stage and repeat the activity.



Before using the product, carefully read the Instructions for Use. It contains, among others, indications, contraindications, side effects, recommendations and warnings related to the use of the product.



The above description is not a detailed instruction of conduct. The surgeon decides about choosing the operating procedure.

www.chm.eu

Document No ST/54A
Date of issue 09.08.2013
Review date P-002-09.12.2020

*The manufacturer reserves the right to introduce design changes.
Updated INSTRUCTIONS FOR USE are available at the following website: ifu.chm.eu*

I. INTRODUCTION	5
I.1. DESCRIPTION AND INDICATIONS	5
I.2. CONTRAINDICATIONS	5
I.3. IMPLANT FEATURES	6

II. IMPLANTS	7
--------------	---

III. INSTRUMENTS	8
III.1. CONTAINERS ARRANGEMENT	10

IV. SURGICAL TECHNIQUE	11
IV.1. SURGICAL APPROACH AND PATIENT POSITION	11
IV.2. DISCECTOMY	12
IV.3. TRIALING	13
IV.4. ENDPLATE PREPARATION	13
IV.5. IMPLANT PREPARATION	14
IV.6. IMPLANT INSERTION	15
IV.7. IMPLANT INSERTION - ALTERNATIVE METHOD	15
IV.8. SCREW INSERTION	16

V. IMPLANT REMOVAL	18
--------------------	----

I. INTRODUCTION

I.1. DESCRIPTION AND INDICATIONS

The ALIF PEEK Intervertebral Locking Cage system consists of polyetheroetheroketon (PEEK) cages of various widths, heights and angles to adapt best to variety of patients' anatomies.

The ALIF PEEK Intervertebral Locking Cage is designed for use with autograft, as stand-alone device (*without supplemental fixation systems*) for anterior intervertebral body fusion at one level or two contiguous levels of lumbar spine.

The implants are indicated for the treatment of degenerative disc disease (DDD) and grade 1 spondylolisthesis in lumbar spine from L2 to S1.

Degenerative disc disease (DDD) is defined as discogenic back pain with degeneration of the disc confirmed by history and radiographic studies. Patients qualified for treatment should be skeletally mature and have had at least six months of non-operative treatment.

I.2. CONTRAINDICATIONS



Intervertebral ALIF implants are not intended for cervical spine use.

The choice of a particular implant must be carefully considered in terms of patient's overall evaluation.

Circumstances listed below may preclude or reduce the chance of successful outcome:

- Infection, local to the operative site.
- Signs of local inflammation.
- Fever or leukocytosis.
- Morbid obesity (*defined according to the W.H.O. standards*).
- Pregnancy.
- Neuromuscular disorder which would create unacceptable risk of fixation failure or complications in postoperative care.
- Any other condition which would preclude the potential benefit of spinal implant surgery and disturb the normal process of bone remodeling, e.g. the presence of tumors or congenital abnormalities, fracture local to the operating site, elevation of sedimentation rate unexplained by other diseases.
- Suspected or documented allergy or intolerance to implant materials. Where material sensitivity is suspected, appropriate tests should be made prior to material selection or implantation.
- Any case not needing a fusion.
- Any case not described in the indications.
- Any patient unwilling to cooperate with postoperative instructions; mental illness, senility or substance abuse (*these conditions may cause the patient to ignore certain necessary limitations and precautions in the use of the implant*).
- Patients with a known hereditary or acquired bone friability or calcification problem should not be considered for this type of surgery.
- These devices must not be used for pediatric cases, nor where the patient still has general skeletal growth.
- Spondylolisthesis unable to be reduced to Grade 1.
- Any case where the implant components selected for use would be too large or too small to achieve a successful result.
- Any case that requires the mixing of metals from two different components or systems.
- Any patient having inadequate tissue coverage over the operative site or inadequate bone stock or quality.
- Any patient in whom inserted implant would interfere with anatomical structures or expected physiological performance.
- Prior fusion at the level to be treated.

The above list is not exhaustive.

For further information on:



- adverse effects,
- warnings,
- sterilization,
- pre- and post-operative recommendations,

please refer to the Instructions For Use enclosed to the implant package unit.

I.3. IMPLANT FEATURES

PEEK

- Stiffness of biocompatible PEEK polymer approximates the host bone, which provides ideal load sharing attributes.
- Radiolucency of PEEK polymer offers an accurate visualization and assessment of the fusion.
- Radioopaque tantalum markers facilitate intraoperative X-Ray visualization of inserted implant.

ANATOMICAL DESIGN

The serrated surface of the implant is convex shaped to fit the anatomy of the disc space.

SERRATIONS

Serrated superior and inferior surfaces designed to provide stability by engaging vertebral endplates.

OPEN DESIGN

Big holes for bone graft which provide ingrowth of bone tissue.

STAND-ALONE

The ALIF PEEK Intervertebral Locking Cage is stand-alone device, not requiring supplemental fixation systems. The ALIF locking cage is equipped with integrated titanium insert, which together with four locking bone screws provide secure locking mechanism to stable fixation of vertebral bodies.

II. IMPLANTS

Intervertebral cage

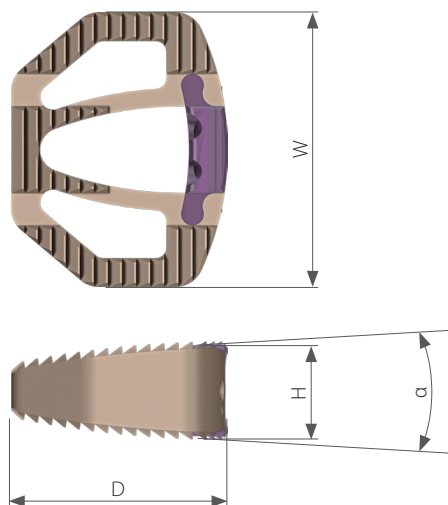

Size	W [mm]	D [mm]	H [mm]	Lordosis angle	
				α = 8°	α = 12°
MEDIUM	32	26	12,0	8.3992.082	8.3992.122
			13,5	8.3992.083	8.3992.123
			15,0	8.3992.085	8.3992.125
			17,0	8.3992.087	8.3992.127
			19,0	8.3992.089	8.3992.129
LARGE	38	30	12,0	8.3993.082	8.3993.122
			13,5	8.3993.083	8.3993.123
			15,0	8.3993.085	8.3993.125
			17,0	8.3993.087	8.3993.127
			19,0	8.3993.089	8.3993.129

Material PEEK-



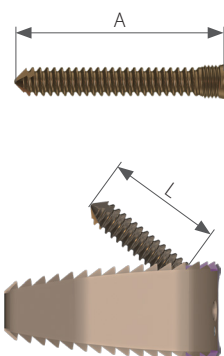



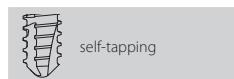





Locking screw 4.5

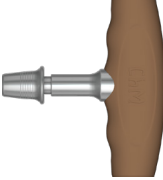

A [mm]	L [mm]	Catalogue no.
15	10	3.3920.015
20	15	3.3920.020
25	20	3.3920.025
30	25	3.3920.030

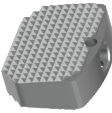

III. INSTRUMENTS

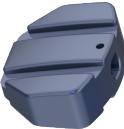
Instrument set for ALIF PEEK Intervertebral Locking Cages 40.5830.000	Name	Catalogue no.	Pcs
	Persuader	40.6224.000	1
	Trocar	40.6246.000	1
	Screwdriver T15	40.5822.000	1
	Distraction forceps	40.5826.000	1
	Dissecting forceps Standard 30cm	30.3317.000	1
	Mallet	40.6247.000	1
	Compactor	40.6190.000	1
	T-type torque handle 2.8Nm	40.6666.000	1
	Stand for ALIF PEEK Locking Cage instrument set 1	40.5831.100	1
	Holder	40.5820.000	1
	Aiming block H12	40.5821.002	1
	Aiming block H13.5	40.5821.003	1
	Aiming block H15	40.5821.005	1
	Aiming block H17	40.5821.007	1
	Aiming block H19	40.5821.009	1
	Bone rasp medium 12	40.5816.002	1
	Bone rasp medium 13.5	40.5816.003	1
	Bone rasp medium 15	40.5816.005	1
	Bone rasp medium 17	40.5816.007	1
	Bone rasp medium 19	40.5816.009	1
	Medium trial 12/8	40.5818.082	1
	Medium trial 12/12	40.5818.122	1
	Large trial 12/8	40.5819.082	1
	Large trial 12/12	40.5819.122	1
	Medium trial 13.5/8	40.5818.083	1
	Medium trial 13.5/12	40.5818.123	1
	Large gau trial ge 13.5/8	40.5819.083	1
	Large trial 13.5/12	40.5819.123	1

	Medium trial 15/8	40.5818.085	1
	Medium trial 15/12	40.5818.125	1
	Large trial 15/8	40.5819.085	1
	Large trial 15/12	40.5819.125	1
	Medium trial 17/8	40.5818.087	1
	Medium trial 17/12	40.5818.127	1
	Large trial 17/8	40.5819.087	1
	Large trial 17/12	40.5819.127	1
	Medium trial 19/8	40.5818.089	1
	Medium trial 19/12	40.5818.129	1
	Large trial 19/8	40.5819.089	1
	Large gauge 19/12	40.5819.129	1
	Working stand	40.5825.000	1
	Stand for ALIF PEEK Locking Cage instrument set 2	40.5831.200	1
	Perforated aluminum lid 1/1 595x275x15mm Gray	12.0750.200	1
	Container with solid bottom 1/1 595x275x135mm	12.0750.102	1

Medium trial

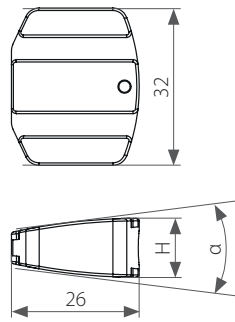

Size	Colors	H [mm]	Lordosis angle	
			$\alpha = 8^\circ$	$\alpha = 12^\circ$
MEDIUM		12,0	40.5818.082	40.5818.122
		13,5	40.5818.083	40.5818.123
		15,0	40.5818.085	40.5818.125
		17,0	40.5818.087	40.5818.127
		19,0	40.5818.089	40.5818.129

Large trial

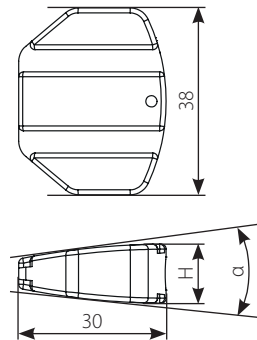

Size	Colors	H [mm]	Lordosis angle	
			$\alpha = 8^\circ$	$\alpha = 12^\circ$
LARGE		12,0	40.5819.082	40.5819.122
		13,5	40.5819.083	40.5819.123
		15,0	40.5819.085	40.5819.125
		17,0	40.5819.087	40.5819.127
		19,0	40.5819.089	40.5819.129

III.1. CONTAINERS ARRANGEMENT

No.	Name	Catalogue No.	Pcs
1	Perforated aluminum lid 1/1 595x275x15mm Gray	12.0750.200	1
2	Stand for ALIF PEEK Locking Cage instrument set 1	40.5831.100	1
3	Stand for ALIF PEEK Locking Cage instrument set 2	40.5831.200	1
4	Container with solid bottom 1/1 595x275x135mm	12.0750.102	1



IV. SURGICAL TECHNIQUE

IV.1. SURGICAL APPROACH AND PATIENT POSITION

The surgical approach depends on the level to be treated, however, direct anterior access to lumbar spine is required for the insertion of the locking screws.

The desired level may be approached through a transperitoneal or retroperitoneal exposure (*depending on surgeon's preference*).

The surgery should be preceded by thorough preoperative plan and carried out with the participation of a vascular surgeon or general surgeon trained as a spinal access surgeon.

The operating table should be radiolucent and should allow for intraoperative C-arm movement.

The patient is placed in the supine position to allow anterior access to the lumbar vertebral bodies.

During implant placement an intraoperative adjustability of lordosis using a hinged table or inflatable pillow is often useful.

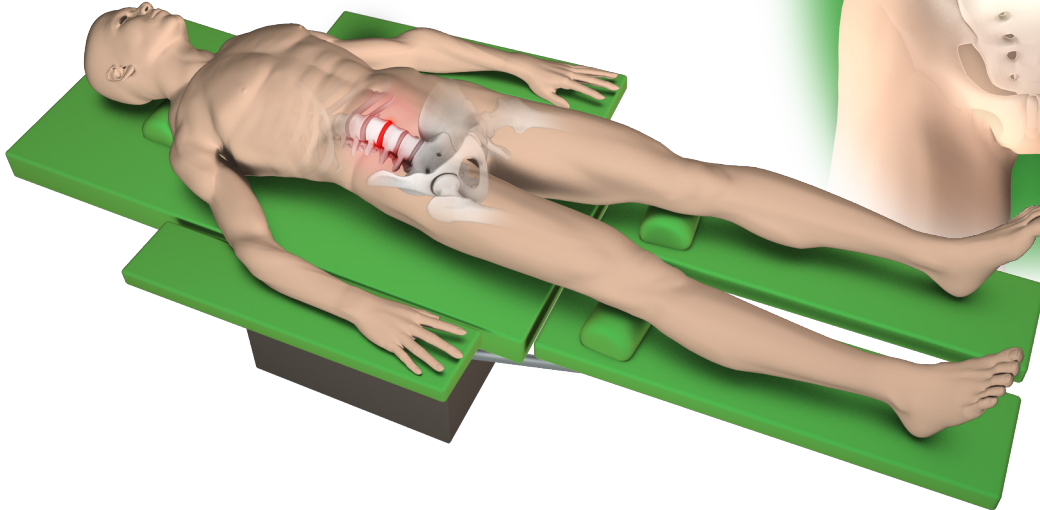

Locate correct operative disc level and expose segment to produce sufficient space on either side of the vertebral midline, equal to the width of the implant (*two implant widths are available, 32mm and 38mm*).

Mark the midline of vertebrae above and below the discectomy site.

IV.2. DISCECTOMY

Perform a discectomy wide enough to accommodate the chosen size of the implant, ensuring the posterolateral corners of the vertebral space are freed of disc material. On this stage a trial (*medium or large*) may be used to determine the appropriate implant width.

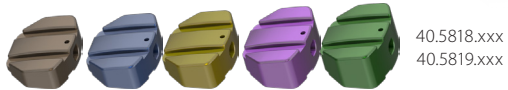
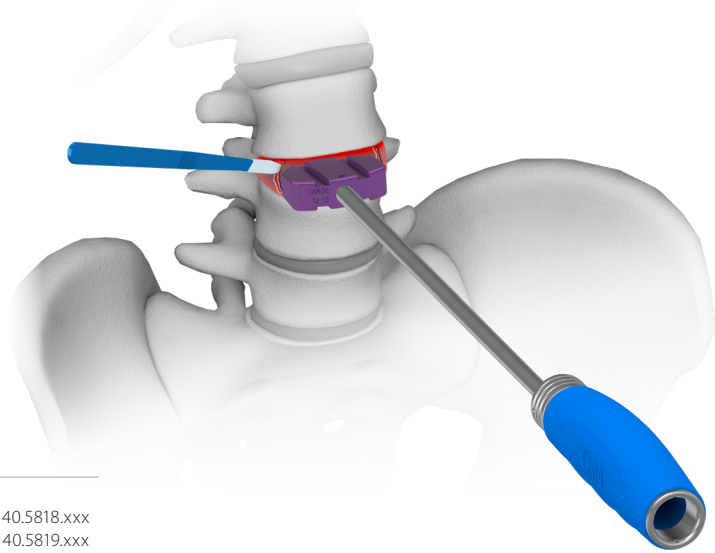

40.5818.xxx
40.5819.xxx



40.6224.000

Remove the superficial layers of the cartilaginous endplates. This can be done with instruments such as curettes and rasps. Adequate preparation of the endplates is important to enhance vascular supply to the implantation site.



Excessive removal of subchondral bone may weaken the vertebral bodies and, consequently, may result in implant subsidence and loss of stability of the segment.



Curettes are not included in the instrument set.

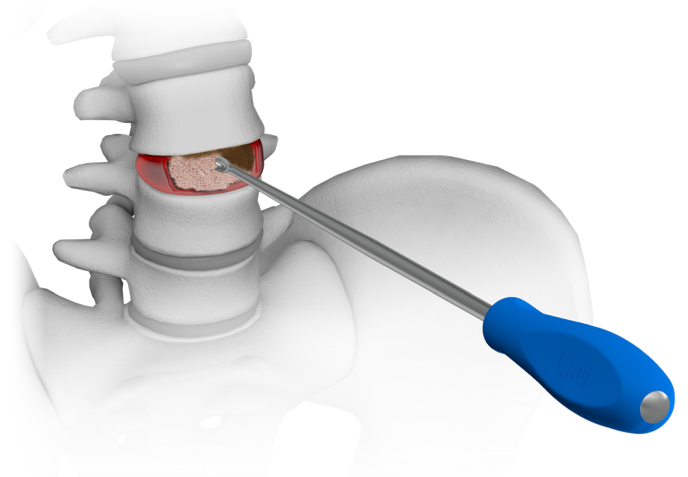

IV.3. TRIALING

The optimal implant width and height can be determined by using the trials [40.5818.xxx] and [40.5819.xxx] which are available in two sizes (*Medium - width 32mm and Large - width 38mm*), two angular versions (*8° and 12°*) and five heights 12mm, 13.5mm, 15mm, 17mm and 19mm.

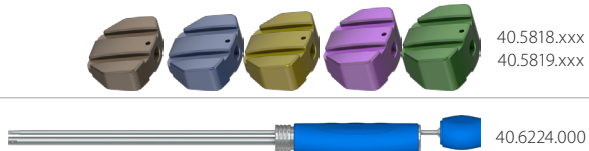

To facilitate proper selection of the implant, trial implants are laser etched with the size (*Medium or Large*), height and lordotic angle. Trials and fixation plates (*integrated with the implant*) are color coded.

Select the medium trial 32mm [40.5818.082] with angle of 8° and 12mm in height, attach to the persuader [40.6224.000] and insert into the discectomy site. If the medium trial is too narrow, switch it to large trial 38mm [40.5819.082].

Once the width is determined, use incrementally higher trials until a tight fit is achieved. There should be no gaps between the prepared site and the trial. Use the largest size possible to ensure maximum stability.

A distraction forceps [40.5826.000] may be used to assist guiding the trial into the intervertebral space.

An intraoperative lateral X-Ray image can be taken to illustrate posterior endplate contact with the trial. If necessary, use the 12° trial instead of 8° to fit better to lumbar lordosis.



Prior to attaching the trial, remove screwdriver T15 from the persuader 40.6224.000.

IV.4. ENDPLATE PREPARATION

Once final sizing has been determined, use the appropriate size of the rasp to complete endplate preparation. Insert rasp [40.5821.xxx] attached to the persuader into intervertebral space and remove the cartilage and bone material until bleeding bone is exposed.



Excessive removal of subchondral bone may weaken the vertebral bodies and, consequently, may result in implant subsidence and loss of stability of the segment.



Prior to attaching the rasp, remove screwdriver T15 from the persuader 40.6224.000.

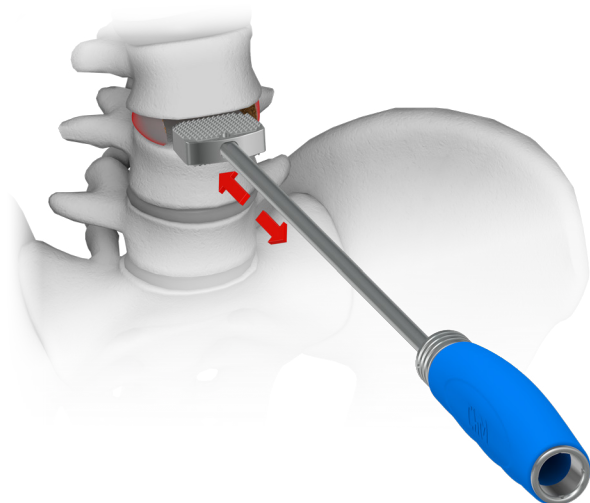
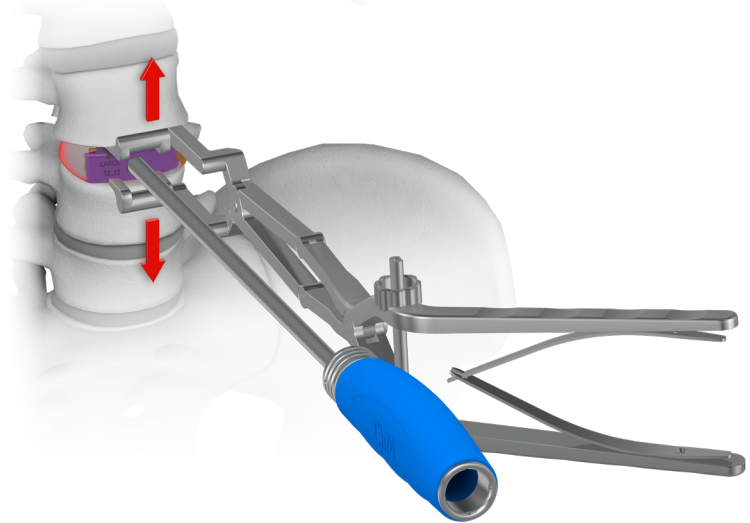
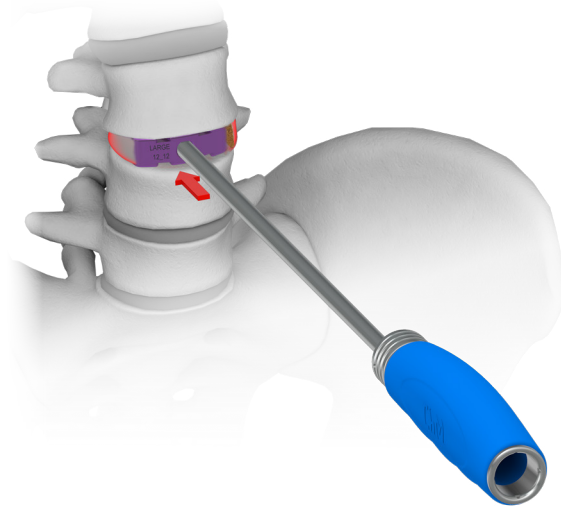

IV.5. IMPLANT PREPARATION

When implant insertion without use of the distraction forceps is planned (*by punching the implant in the intervertebral space*), attach the adequate aiming block [40.5821.xxx] on the quick coupling tip of the persuader [40.6224.000].

Then, position the assembled instrument so that both, positioning pin and threaded tip of cooperating screwdriver (*located symmetrically on both sides of the aiming block*) align with the corresponding holes in the implant. Then, turning the knob clockwise, fasten the instrument to the implant.

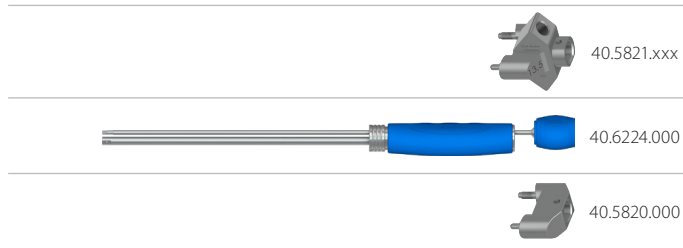

When implant insertion with the use of distraction forceps [40.5826.000] is planned, the use of the holder [40.5820.000] is needed. Attachment of the aiming block should take place at the later stage.



Insertion of the implant using aiming block [40.5821.xxx] will cause distraction forceps removal impossible.

Attach the holder [40.5820.000] on the quick coupling tip of the persuader [40.6224.000], and then rotating knob of cooperating screwdriver clockwise, fasten the implant to the instrument.

Place the implant in the working stand [40.5825.000] and fill it with auto-graft material.

Use compactor [40.6190.000] to firmly pack the filling material into the implant cavities.

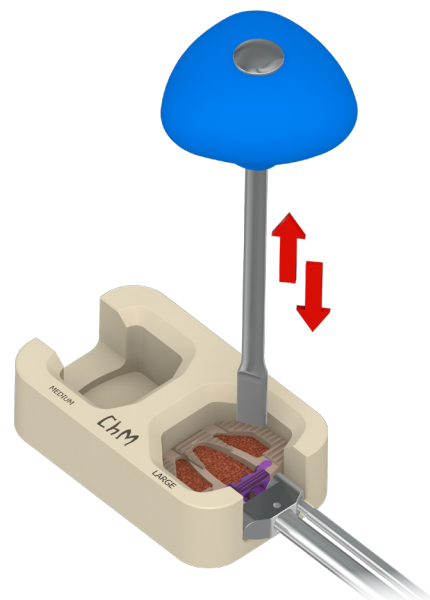
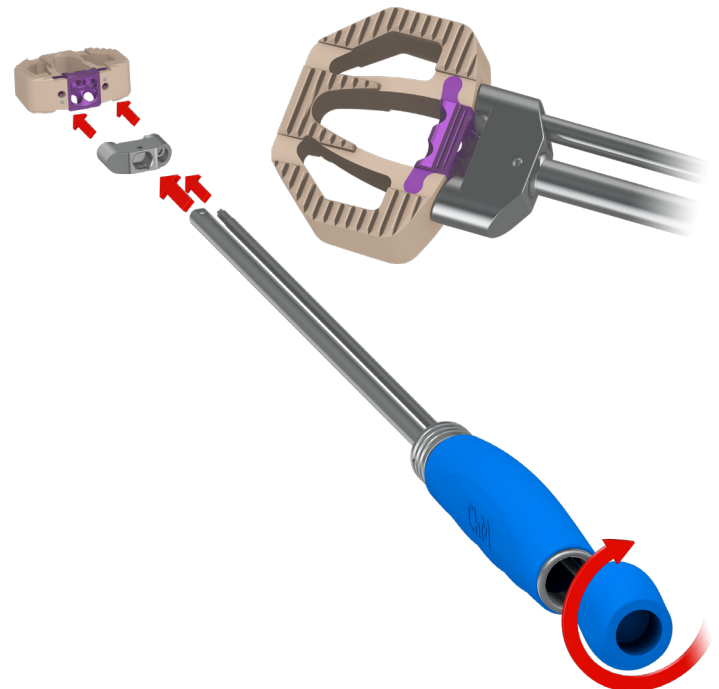
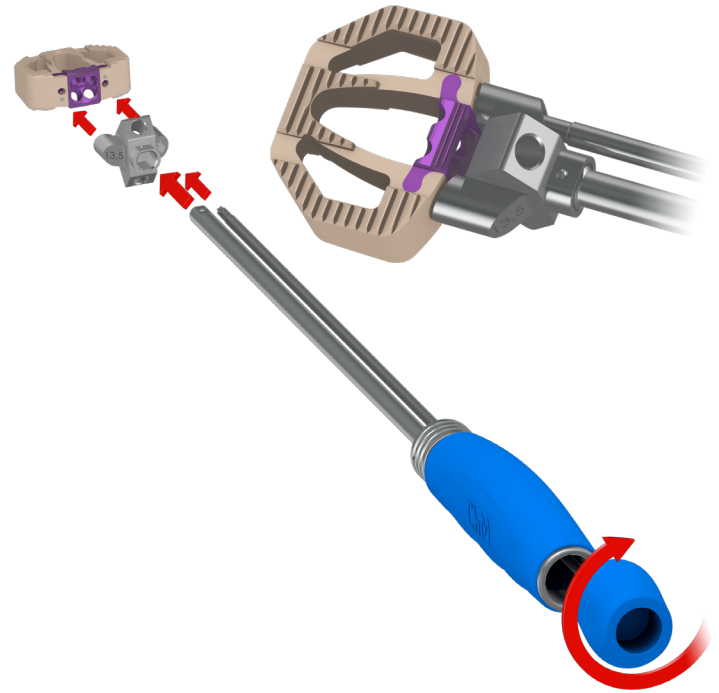
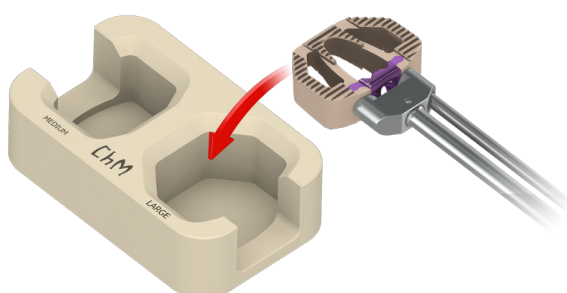
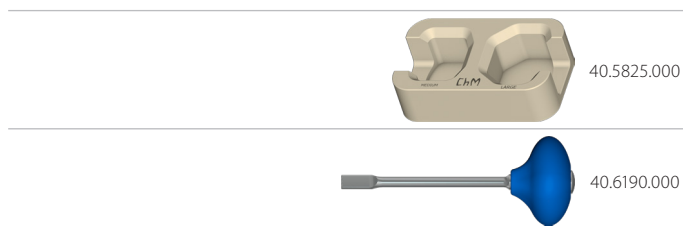

IV.6. IMPLANT INSERTION

The distraction forceps [40.5826.000] can be used to facilitate implant insertion. In such case, once the cage is inserted, release the distractor to make sure the implant is fully engaged with vertebral endplates.

After distractor removal, make sure the implant is properly fitted by delicate tapping the persuader handle [40.6224.000] with the mallet [40.6847.000]. Remove the holder by rotating the knob counterclockwise.



While implant insertion, remove screwdriver T15 from the persuadre.

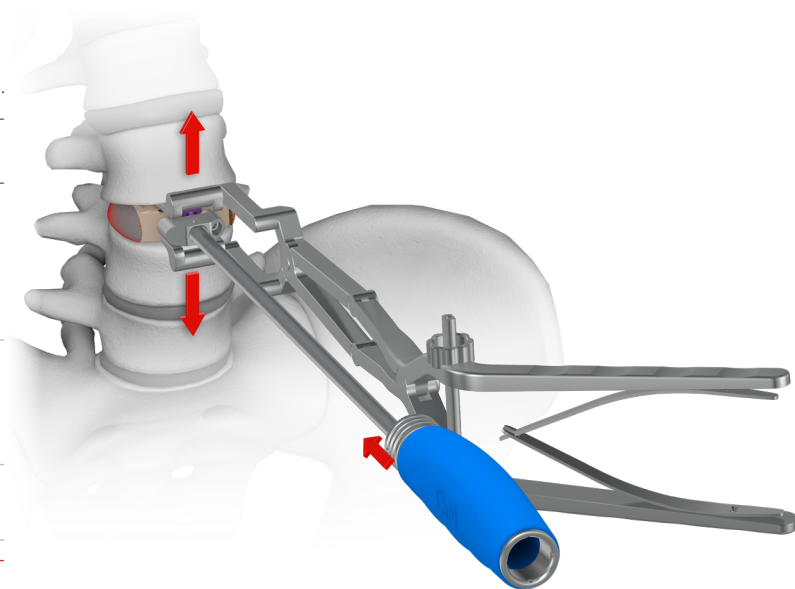

IV.7. IMPLANT INSERTION - ALTERNATIVE METHOD

Insert the implant into intervertebral space, taking care to align the sagittal plane of the implant with the previously marked vertebrae midline.

Make sure the implant is fully engaged with vertebral endplates by tapping the persuader handle [40.6224.000] with the mallet [40.6247.000].



While implant insertion, remove screwdriver T15 from the persuadre.

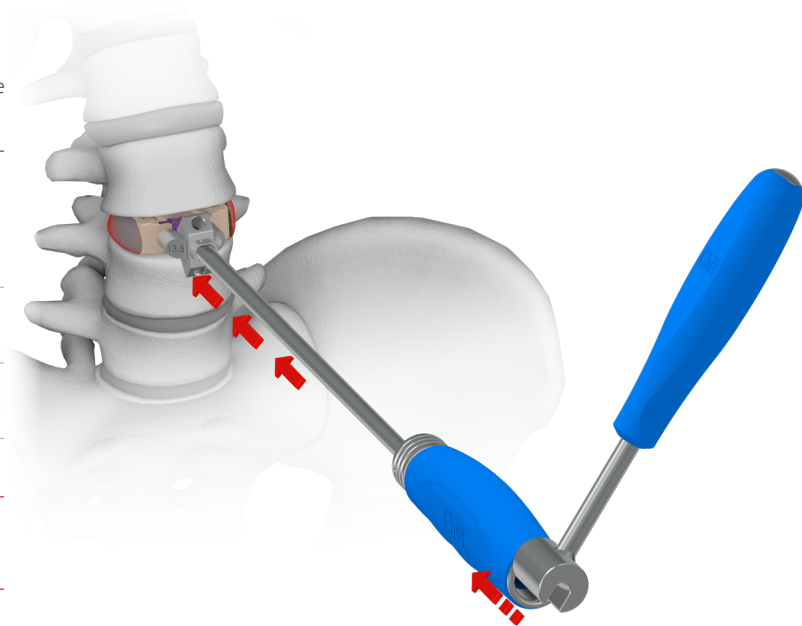

Remove the persuader by releasing the lock (as shown on picture), leaving the aiming block attached to the implant.



Verify proper implant position with the use of an intraoperative lateral X-Ray.



IV.8. SCREW INSERTION

Has it not been done before, select the aiming block [40.5821.xxx] with size corresponding to the size of the implant and attach to the quick coupling tip of persuader [40.6224.000].

Then, turning the knob clockwise, fasten the instrument to the implant.

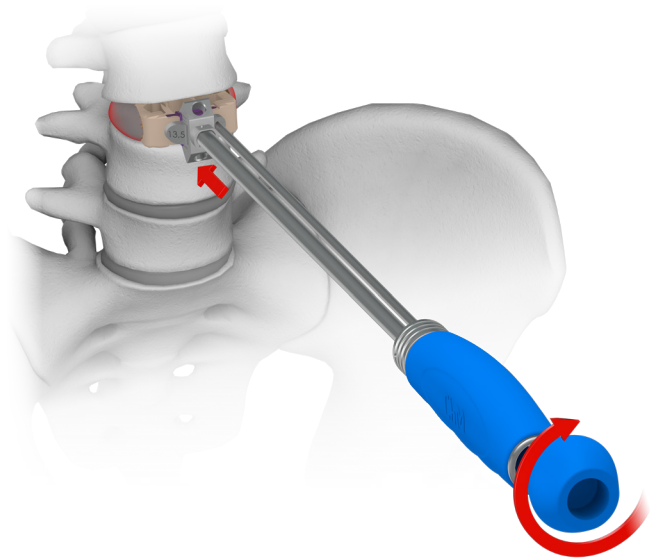
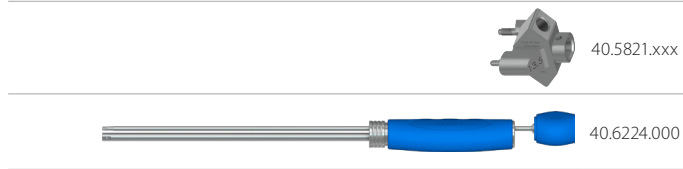

Insert the trocar [40.6246.000] into a chosen hole of the aiming block. Applying pressure on the handle of the trocar, perform a series of oscillating movements to prepare the hole for a locking screw insertion. The forceps [30.3317.000] should be used during insertion of the trocar to avoid injury of surrounding soft tissue and to provide directional control of hinged tip of the trocar.



A lateral X-Ray image should be taken now in order to determine the proper screw length.

Repeat the procedure for the other hole in the aiming block.



Length of selected screws should allow the penetration through the entire cortex. For a two-level procedure, the length of the screws should be selected carefully to prevent their possible interference.

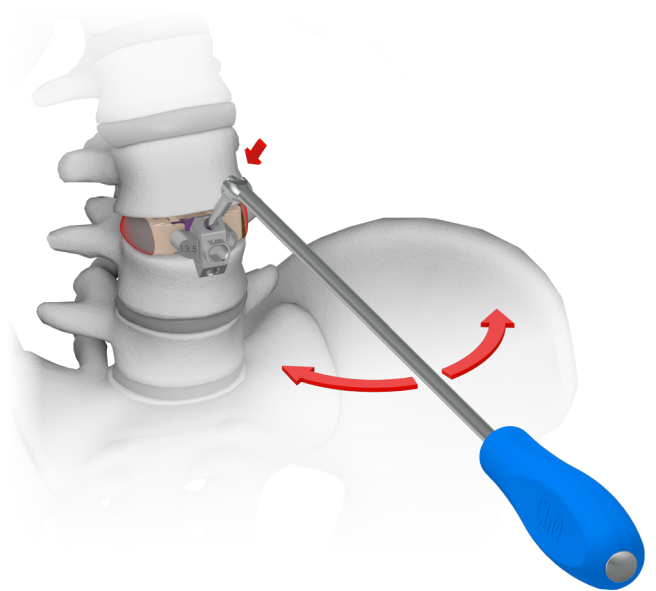
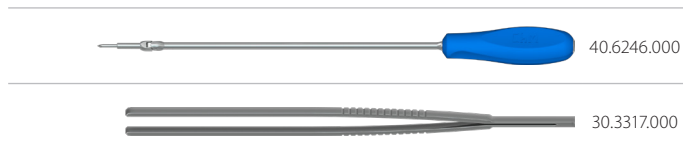

Choose the proper size of a locking screw, attach it to the tip of the screwdriver T15 [40.5822.000] (that is mounted to the torque handle 2.8Nm [40.6666.000]) and insert it through the hole of the aiming block [40.5821.xxx].

When the laser etched marking on the screwdriver meets the entry point of the aiming block guiding hole, the screw's head is locked in implant's titanium insert. Tighten the screw up.

Repeat the procedure for the other hole of the aiming block.

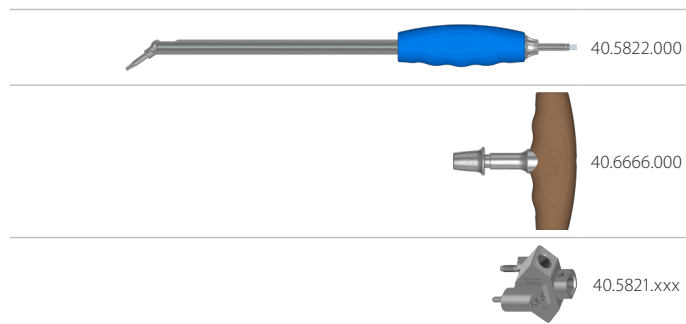

To insert the two remaining locking screws, the aiming block must be rotated by 180°.

For this purpose, re-attach the persuader to the aiming block, release the threaded locking pin by turning the knob counterclockwise. Then rotate the aiming block by 180° and fix again. Prepare the holes and insert locking screws as described in section IV.8.

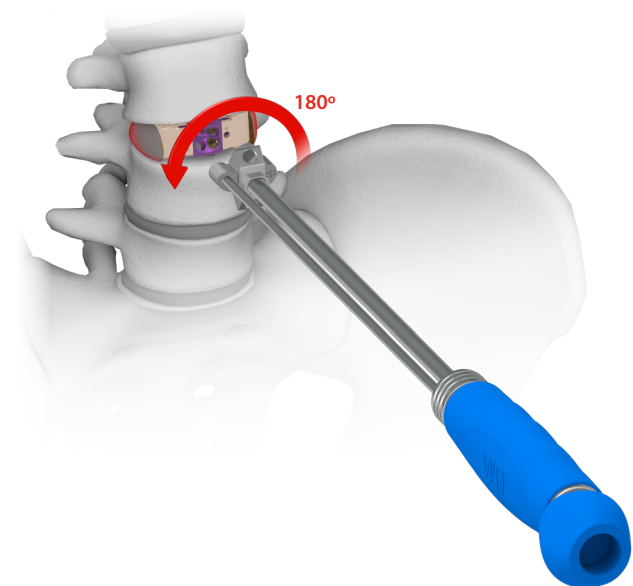
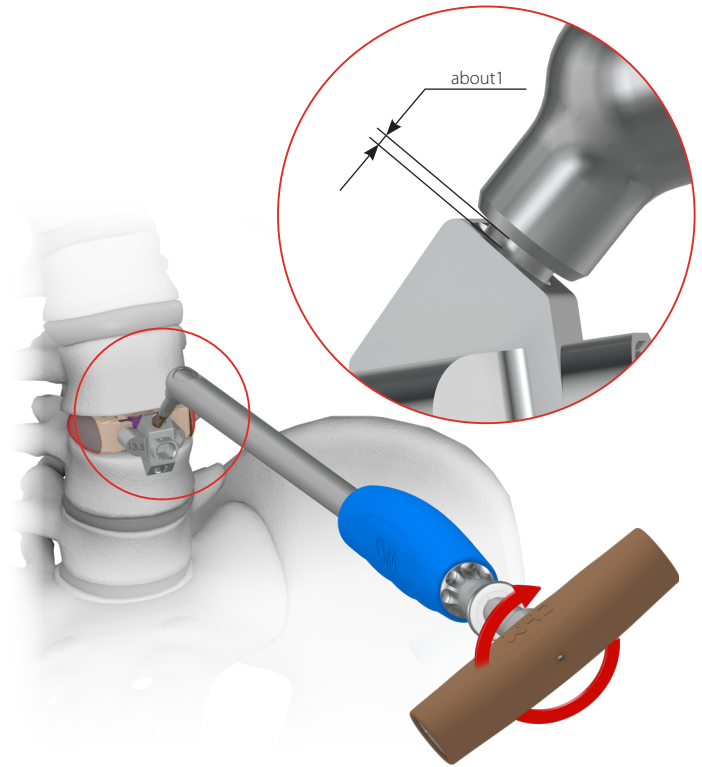

V. IMPLANT REMOVAL

Should it become necessary to remove the ALIF PEEK locking cage, the following steps should be taken:

- remove soft tissue from the anterior surface of the implant;
- remove the screws with use of T15 screwdriver [40.5822.000] (that is mounted to torque handle [40.6666.000]);

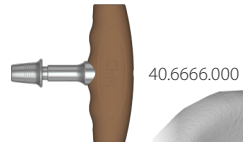
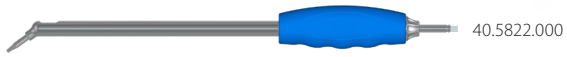

- once all screws are removed, assembly the persuader [40.6224.000] with the holder [40.5820.000] and then attach to the implant;
- distract the vertebrae with the use of distraction forceps [40.5826.000];
- if need be, use mallet [40.6247.000] to punch the implant out from the intervertebral space.

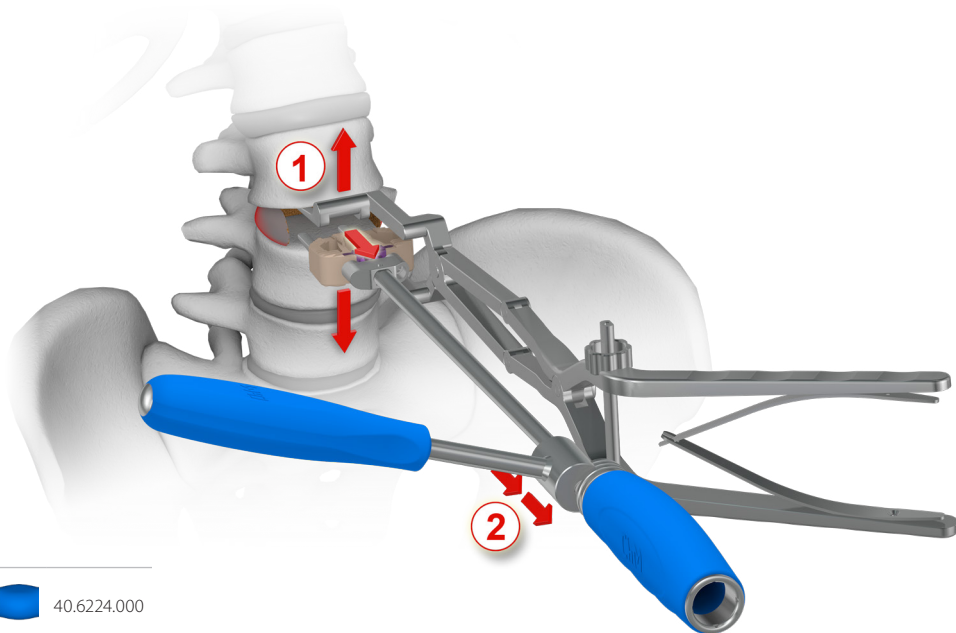
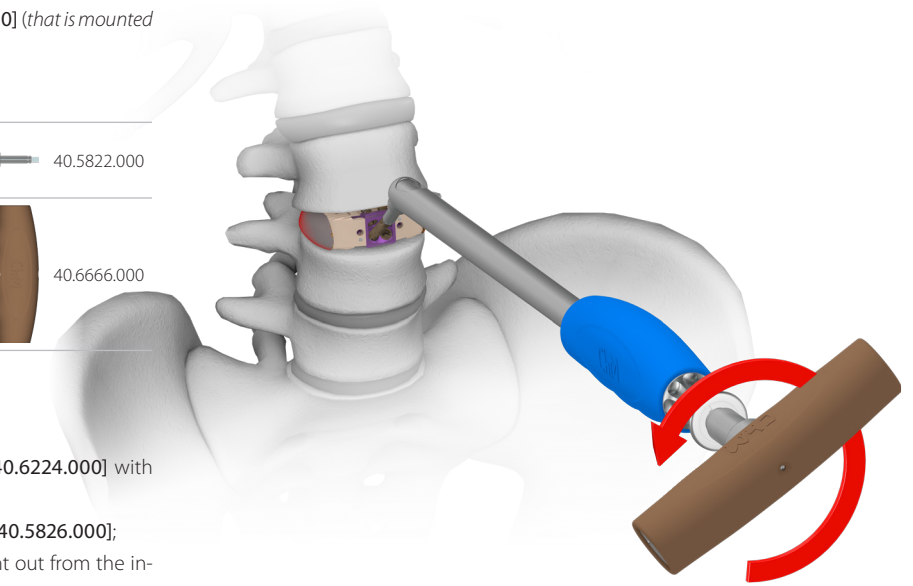

ChM sp. z o.o.

Lewickie 3b
16-061 Juchnowiec Kościelny
Poland

tel. +48 85 86 86 100

fax +48 85 86 86 101

chm@chm.eu

www.chm.eu



CE 0197