

# CHM<sup>®</sup>

CHARSPINE *system* 3D-Ti  
3D Titanium Trabecular Cage System

CHARSPINE *system* 2

## TLIF INTERVERTEBRAL CAGES

- *IMPLANTS*
- *INSTRUMENT SET 15.0904.101*
- *INSTRUMENT SET 15.0904.201*
- *INSTRUMENT SET 15.0904.102*
- *INSTRUMENT SET 15.0908.201*
- *SURGICAL TECHNIQUE*



## SYMBOLS DESCRIPTION



Caution - pay attention to a special procedure.



Perform the activity under X-Ray control.



Information about the next stages of a procedure.



Proceed to the next stage.



Return to the specified stage and repeat the activity.



Before using the product, carefully read the Instructions for Use. It contains, among others, indications, contraindications, side effects, recommendations and warnings related to the use of the product.



The above description is not a detailed instruction of conduct. The surgeon decides about choosing the operating procedure.

**[www.chm.eu](http://www.chm.eu)**

Document No ST/56B  
Date of issue 02.01.2014  
Review date P-011-30.01.2023

*The manufacturer reserves the right to introduce design changes.*

*Updated INSTRUCTIONS FOR USE are available at the following website: [ifu.chm.eu](http://ifu.chm.eu)*

---

I. INTRODUCTION	5
I.1. DESCRIPTION AND INDICATIONS	5
I.2. CONTRAINDICATIONS	5
I.3. IMPLANT FEATURES	6

---

II. IMPLANTS	7
--------------	---

---

III. INSTRUMENTS	8
III.1. CONTAINERS ARRANGEMENT	11

---

IV. SURGICAL TECHNIQUE	13
IV.1. SURGICAL APPROACH AND PATIENT POSITIONING	13
IV.2. REMOVAL OF ARTICULAR PROCESSES	14
IV.3. INSERTION OF TRANSPEDICULAR SCREWS FROM <b>CHARSPINE2</b> SYSTEM ( <i>OPTIONAL</i> )	14
IV.4. DISTRACTION ( <i>OPTIONAL</i> )	15
IV.5. DISCECTOMY	16
IV.6. PREPARATION OF THE ENDPLATE SURFACES OF VERTEBRAL BODIES	17
IV.7. IMPLANT SIZE SELECTION	18
IV.8. IMPLANT AND APPLICATOR ASSEMBLY	19
IV.9. INSERTION OF INTERVERTEBRAL CAGE	21
IV.10. TRANSPEDICULAR STABILIZATION	21
IV.11. IMPLANT REMOVAL	21



## I. INTRODUCTION

### I.1. DESCRIPTION AND INDICATIONS

TLIF Intervertebral cage system is intended for the treatment of diseases caused by disorders of the function of the intervertebral discs in the lumbar spine, at levels from L2 to S1 in skeletally mature patients. The diseases include, i.a.: degenerative disc disease (*DDD*), vertebral instability, spondylolisthesis, herniated discs.

TLIF Intervertebral cage system comprises cages of various widths, heights and lordotic angles to adapt best to a patient's spinal anatomy.

TLIF intervertebral cages are made of biocompatible PEEK (*polyether ether ketone*) polymer or biocompatible titanium alloy. For the manufacture of the latter, the additive manufacturing technique with use of Selective Laser Melting (*SLM*) technology (*3D*) is used. This technology ensures a spatial structure inside the implant for the bone tissue to overgrow the cage.

TLIF Intervertebral cage system is designed for implantation via posterolateral (*transforaminal*) approach.

### I.2. CONTRAINDICATIONS



**Intervertebral TLIF implants are not intended for use in cervical spine.**

The selection of an appropriate device must be preceded by careful and thorough assessment of patient's state of health.

The conditions listed below may preclude or diminish the chances of successful surgery outcome:

- Local infection (*at the operative site*).
- Symptoms of local inflammation.
- Fever or high leukocytosis.
- Morbid obesity (*specified according to the WHO standards*).
- Pregnancy.
- Neuromuscular disorders which could pose a high risk of surgery failure or occurrence of postoperative complications.
- Any other condition which could preclude any potential benefits resulting from spinal implant usage and could disturb normal bone remodelling, e.g.: the presence of tumors or congenital abnormalities, fracture at the operative site, increase in erythrocyte sedimentation rate unjustified by other diseases.
- Suspected or documented allergy to or intolerance of implant materials. When the patient's oversensitivity to the material used is suspected, appropriate tests should be performed prior to implantation.
- Any situation in which there is no need to surgically stabilize the spine.
- Any situation not described in the indications.
- Any patient unwilling to follow postoperative recommendations; mental illness, senility or substance abuse (*these conditions may cause the patients to ignore limitations and precautions regarding the implant use*).
- Patients with known hereditary or acquired bone fragility or problems with bone calcification should not be considered for this type of surgery.
- These devices shall not be used for treating children or patients who still undergo skeletal growth.
- Spondylolisthesis unable to be reduced to Grade 1.
- Any situation in which the selected implant components would be too large or too small to achieve a desired result.
- Any situation in which the tissue coverage, bone material or bone quality at the operative site are insufficient.
- Any situation in which the use of implant would interfere with anatomical structures or physiological processes.
- Prior fusion at the level to be treated.

**The above-mentioned list of contraindications is not exhaustive.**

**For further information on:**



- **adverse effects,**
- **warnings,**
- **sterilization,**
- **pre- and post-operative recommendations,**

**please refer to the Instructions For Use attached to the implant unit package.**

### I.3. IMPLANT FEATURES

TLIF intervertebral cages have a curved (*kidney-shaped*) form which facilitates the procedure of their implantation and ensures their perfect match to the curvature of the anterior walls of the vertebral bodies. The wedge shape of one of ends guarantees smooth implant insertion and positioning between the vertebral bodies. Each implant has been equipped with a special mechanism for problem-free change of the angle of the implant's position relative to the insertion instrument (*from 0° to 80° for PEEK polymer cages and up to 95° for cages made of 3D-printed titanium alloy*) during the implantation procedure. All TLIF intervertebral cages manufactured by **ChM** are handled with one instrument set what simplifies and reduces the costs of the procedure.

#### TLIF PEEK

- Stiffness of biocompatible PEEK polymer approximates the stiffness of a patient's bone which provides ideal load distribution.
- Radiolucency of PEEK polymer allows for precise visualisation and assessment of the bone fusion.
- Radiopaque tantalum markers facilitate an intraoperative X-Ray visualisation and positioning of the implant.
- Upper and lower serrated implant surfaces designed to provide stability via anchoring in vertebral bodies.
- Open design for bone tissue ingrowth.

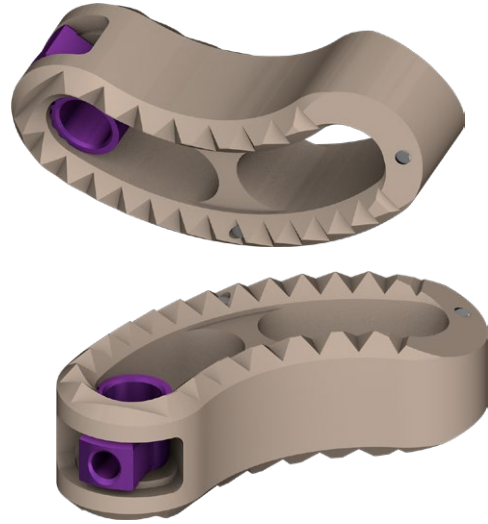

#### 3D-Ti TLIF

- A spatial structure for bone tissue ingrowth.
- Properly shaped contact surfaces of the implant with bodies facilitating implantation.

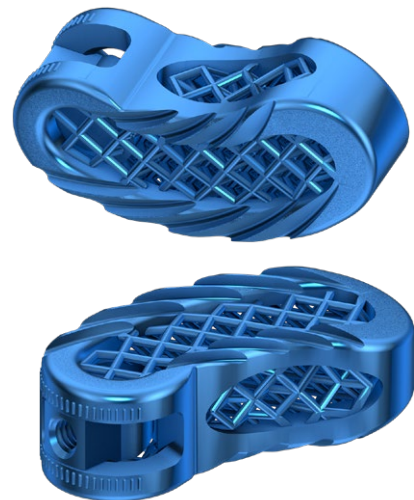

II. IMPLANTS

TLIF PEEK Intervertebral cage

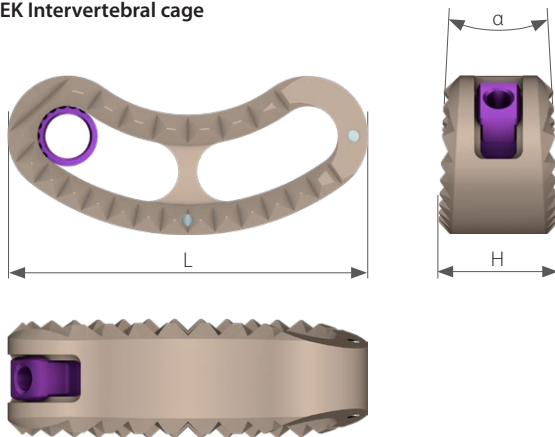

TLIF PEEK intervertebral cages are available non-sterile and sterile.  
For sterile implants, add suffix „S” to the catalog number (e.g. 8.4550.007S)

Lordosis angle

L [mm]	H [mm]	Lordosis angle		
		α = 0°	α = 5°	
26		Catalogue no.		
	7	8.4550.007	8.4551.007	
	8	8.4550.008	8.4551.008	
	9	8.4550.009	8.4551.009	
	10	8.4550.010	8.4551.010	
	11	8.4550.011	8.4551.011	
	12	8.4550.012	8.4551.012	
	13	8.4550.013	8.4551.013	
	14	8.4550.014	8.4551.014	
	15	8.4550.015	8.4551.015	
	16	8.4550.016	8.4551.016	
	30	7	8.4552.007	8.4553.007
		8	8.4552.008	8.4553.008
		9	8.4552.009	8.4553.009
		10	8.4552.010	8.4553.010
		11	8.4552.011	8.4553.011
12		8.4552.012	8.4553.012	
13		8.4552.013	8.4553.013	
14		8.4552.014	8.4553.014	
15		8.4552.015	8.4553.015	
16		8.4552.016	8.4553.016	

Material: PEEK-

3D-Ti TLIF Intervertebral cage

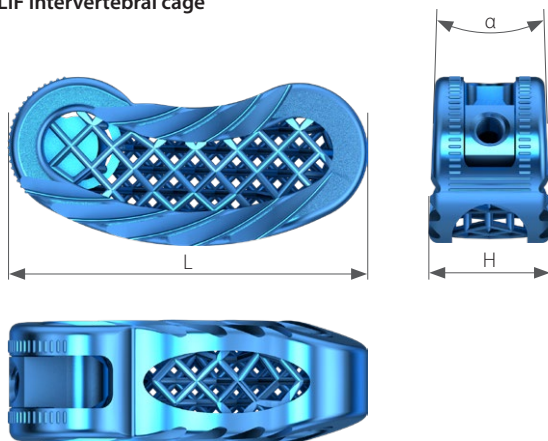

3D-Ti TLIF intervertebral cages are available sterile only.







Lordosis angle

L [mm]	H [mm]	Lordosis angle		
		α = 0°	α = 5°	
26		Catalogue no.		
	7	3.6930.007S	3.6930.507S	
	8	3.6930.008S	3.6930.508S	
	9	3.6930.009S	3.6930.509S	
	10	3.6930.010S	3.6930.510S	
	11	3.6930.011S	3.6930.511S	
	12	3.6930.012S	3.6930.512S	
	13	3.6930.013S	3.6930.513S	
	14	3.6930.014S	3.6930.514S	
	15	3.6930.015S	3.6930.515S	
	16	3.6930.016S	3.6930.516S	
	30	7	3.6931.007S	3.6931.507S
		8	3.6931.008S	3.6931.508S
		9	3.6931.009S	3.6931.509S
		10	3.6931.010S	3.6931.510S
		11	3.6931.011S	3.6931.511S
12		3.6931.012S	3.6931.512S	
13		3.6931.013S	3.6931.513S	
14		3.6931.014S	3.6931.514S	
15		3.6931.015S	3.6931.515S	
16		3.6931.016S	3.6931.516S	
35		7	3.6932.007S	3.6932.507S
		8	3.6932.008S	3.6932.508S
		9	3.6932.009S	3.6932.509S
		10	3.6932.010S	3.6932.510S
		11	3.6932.011S	3.6932.511S
		12	3.6932.012S	3.6932.512S
	13	3.6932.013S	3.6932.513S	
	14	3.6932.014S	3.6932.514S	
	15	3.6932.015S	3.6932.515S	
	16	3.6932.016S	3.6932.516S	

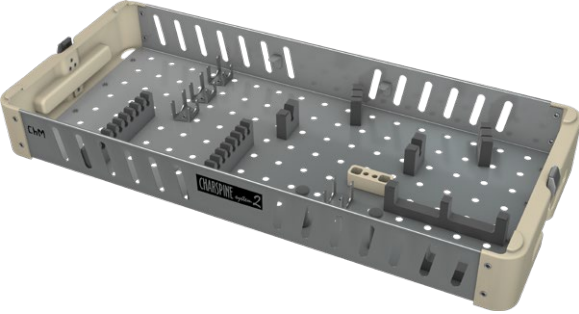

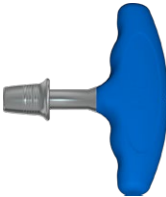







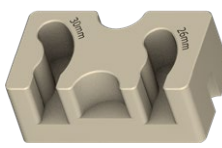

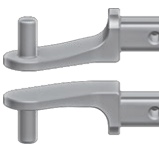
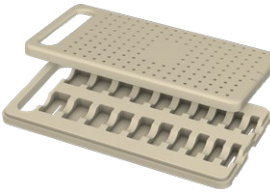
Material:

## III. INSTRUMENTS

Instrument set for TLIF PEEK Intervertebral cages 15.0904.101  
(basic)

	Name	Catalogue no.	Pcs
	Container lid 9x4	14.0904.103	1
	Container 9x4H	14.0904.101	1
	Reamer 7	40.5805.007	1
	Reamer 8	40.5805.008	1
	Reamer 9	40.5805.009	1
	Reamer 10	40.5805.010	1
	Reamer 11	40.5805.011	1
	Reamer 12	40.5805.012	1
	Reamer 13	40.5805.013	1
	Reamer 14	40.5805.014	1
	Reamer 15	40.5805.015	1
	Reamer 16	40.5805.016	1
	Quick coupling handle T-type 1/4"	40.6673	1
	Applicator	40.6216.100	1
	Compactor	40.6218	1
	Impactor	40.6219	1











Instrument set for TLIF PEEK Intervertebral cages 15.0904.101 (basic)		Name	Catalogue no.	Pcs
	Persuader	40.6217	1	
	Working stand	40.6208.000	1	
	Impactor-extractor	40.6209.000	1	
	Elevator 6	40.4467.006	1	
	Elevator 10	40.4467.010	1	
	Distraction forceps-jaws	40.5812.000	1	
	Stand 4x2	14.0904.201	1	
	Big trial 7	40.6205.007	1	
	Small trial 7	40.6206.007	1	
	Trial 35/7	40.6128.007	1	
	Big trial 8	40.6205.008	1	
	Small trial 8	40.6206.008	1	
	Trial 35/8	40.6128.008	1	
	Big trial 9	40.6205.009	1	
	Small trial 9	40.6206.009	1	
	Trial 35/9	40.6128.009	1	
	Big trial 10	40.6205.010	1	
	Small trial 10	40.6206.010	1	
	Trial 35/10	40.6128.010	1	
	Big trial 11	40.6205.011	1	
	Small trial 11	40.6206.011	1	
	Trial 35/11	40.6128.011	1	
	Big trial 12	40.6205.012	1	
	Small trial 12	40.6206.012	1	
	Trial 35/12	40.6128.012	1	
	Big trial 13	40.6205.013	1	
	Small trial 13	40.6206.013	1	
	Trial 35/13	40.6128.013	1	
	Big trial 14	40.6205.014	1	
	Small trial 14	40.6206.014	1	
	Trial 35/14	40.6128.014	1	
	Big trial 15	40.6205.015	1	
	Small trial 15	40.6206.015	1	
	Trial 35/15	40.6128.015	1	
	Big trial 16	40.6205.016	1	
	Small trial 16	40.6206.016	1	
	Trial 35/16	40.6128.016	1	



Instrument set [15.0904.102] is additional equipment.  
In order to include the instruments to the order, please contact your local representative or ChM Sales Department.

Instrument set for TLIF PEEK Intervertebral cages 15.0904.102  
(extended)

	Name	Catalogue no.	Pcs
	Container 9x4H	14.0904.102	1
	Curved file	40.6197	1
	Bone curette rectangular right	40.6194	1
	Bone curette rectangular left	40.6195	1
	Osteotome	40.6191	1
	Bone curette left	40.6201	1
	Bone curette right	40.6200	1
	SPURLING bone rongeur straight 230mm 4x10mm	40.7033.044	1
	SPURLING bone rongeur upwards 230mm, 4x10mm	40.7034.044	1
	KERRISON bone rongeur, upwards, 130°, 230mm, 4mm	40.7086.004	1



Instrument set [15.0908.201] is additional equipment.  
In order to include the instruments to the order, please contact your local representative or ChM Sales Department.

Instrument set for Intervertebral cages - distraction forceps 15.0908.201  
(extended)

Name

Catalogue no.

Pcs

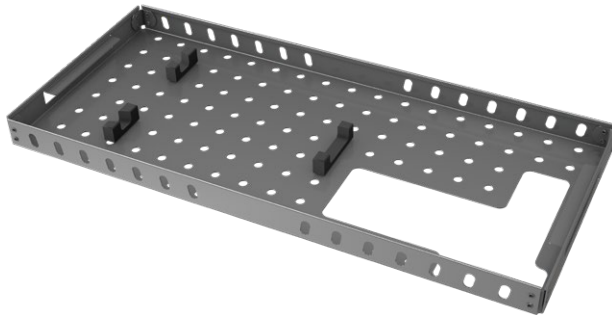

Tray 9x4 1/2H

14.0908.201

1

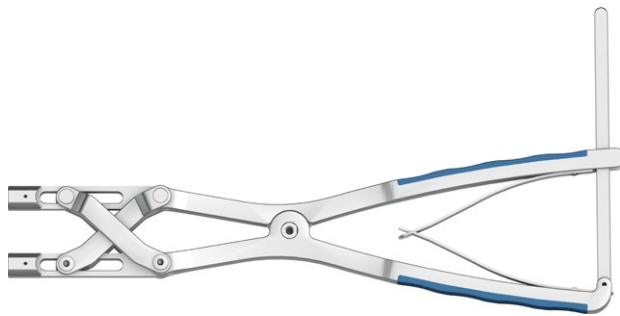

Parallel distraction forceps

40.8093

1

### III.1. CONTAINERS ARRANGEMENT

No.	Name	Catalogue No.	Pcs
1	Container lid 9x4	14.0904.103	1
2	Stand 4x2	14.0904.201	1
3	Container 9x4H	14.0904.101	1
4	Tray 9x4 1/2H	14.0908.201	1
5	Container 9x4H	14.0904.102	1

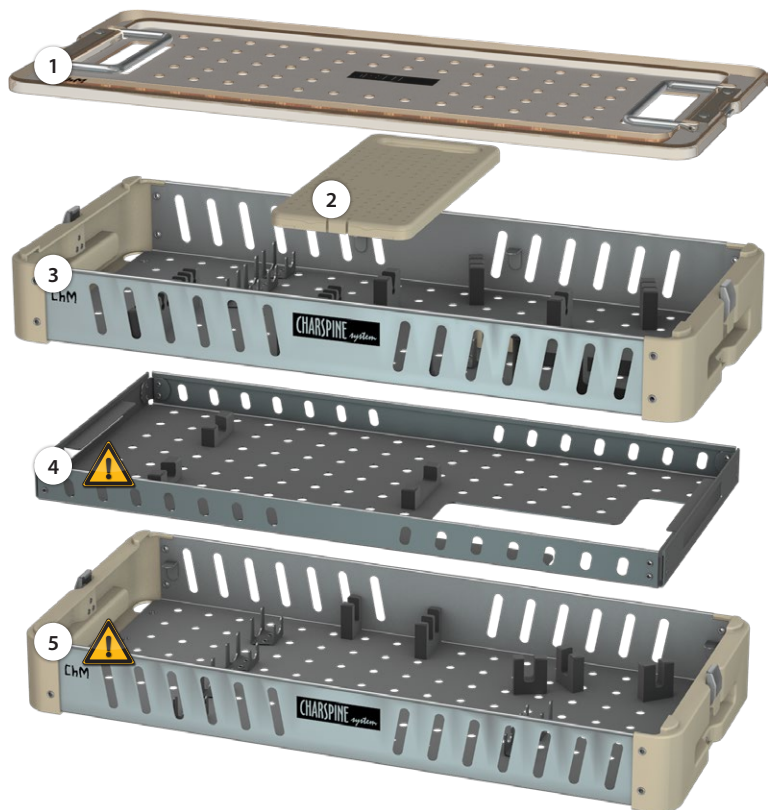

Tray 9x4 1/2H [14.0908.201] (item 4) and container 9x4H [14.0904.102] (item 5) are additional elements and are not included in the basic instrument set.

Trial 35

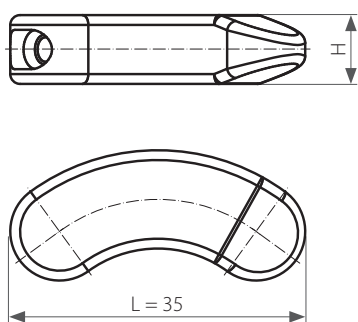

L [mm]	H [mm]	Colours	Catalogue no.
35	7		40.6128.007
	8		40.6128.008
	9		40.6128.009
	10		40.6128.010
	11		40.6128.011
	12		40.6128.012
	13		40.6128.013
	14		40.6128.014
	15		40.6128.015
	16		40.6128.016

Big trial

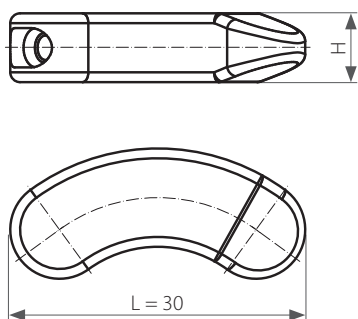

L [mm]	H [mm]	Colours	Catalogue no.
30	7		40.6205.007
	8		40.6205.008
	9		40.6205.009
	10		40.6205.010
	11		40.6205.011
	12		40.6205.012
	13		40.6205.013
	14		40.6205.014
	15		40.6205.015
	16		40.6205.016

Small trial

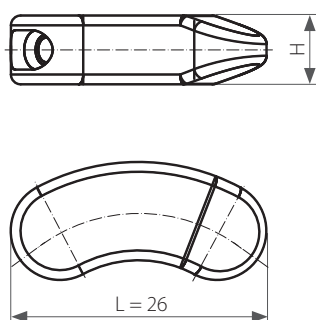

L [mm]	H [mm]	Colours	Catalogue no.
26	7		40.6206.007
	8		40.6206.008
	9		40.6206.009
	10		40.6206.010
	11		40.6206.011
	12		40.6206.012
	13		40.6206.013
	14		40.6206.014
	15		40.6206.015
	16		40.6206.016



## IV. SURGICAL TECHNIQUE

### IV.1. SURGICAL APPROACH AND PATIENT POSITIONING

The patient is placed in a prone position on an operating table with adequate clearance available for the fluoroscopic C-arm. Special care should be taken to secure patient's pressure points.

A posterior midline skin incision is made, and the tissues are dissected laterally. The lamina and articular process are exposed laterally until the transverse processes are visible.

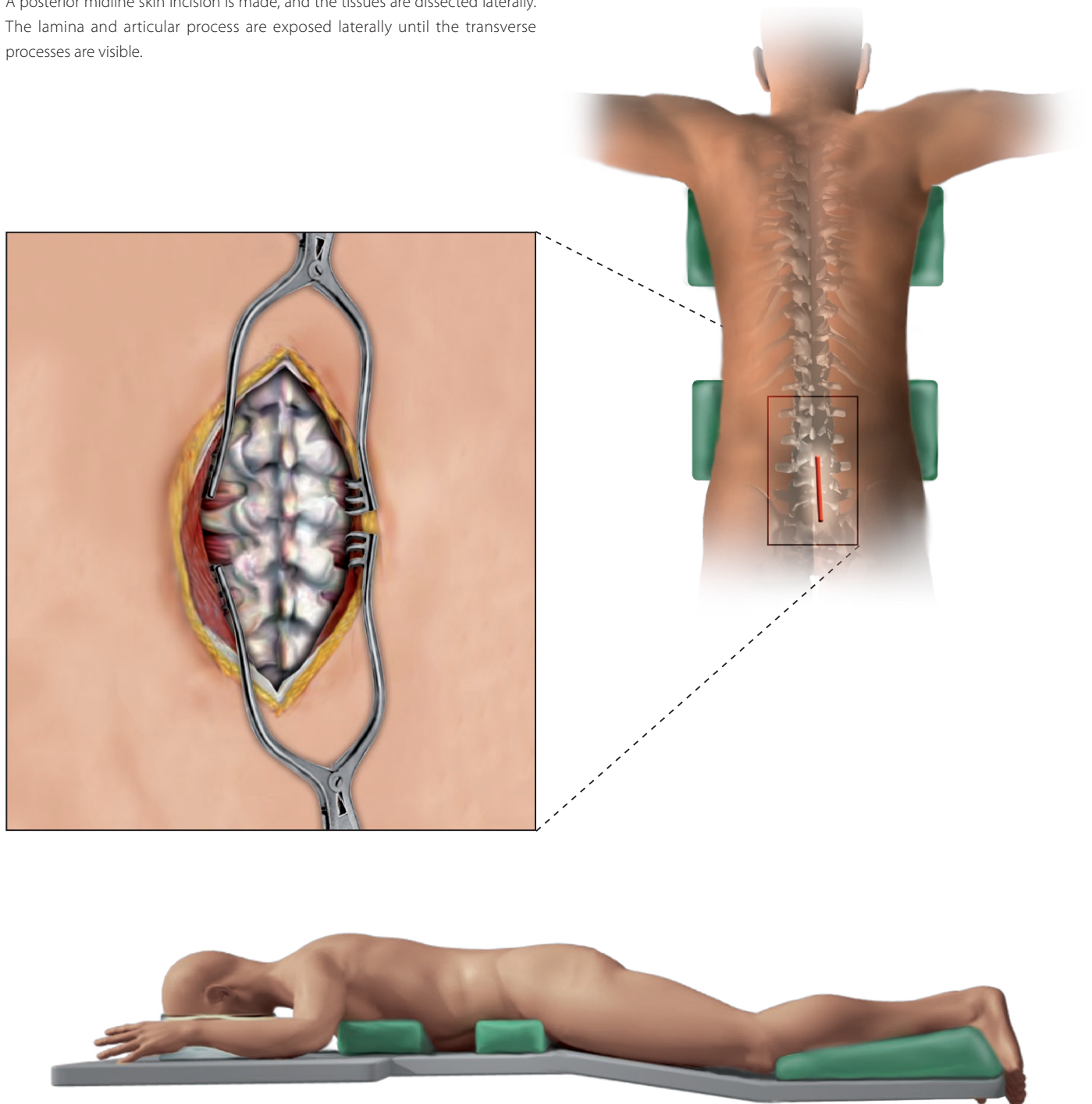

The soft tissue retractors can be used to maintain proper exposure. The C-arm unit can be used to facilitate the precise determination of relevant spinal segments position.

## IV.2. REMOVAL OF ARTICULAR PROCESSES

To insert an implant, it is necessary to prepare an entry point. It is prepared by lateral removal, with the help of osteotome or Kerrison ronguer, of an inferior articular process with a part of vertebral arch lamina that is located above the affected intervertebral disc, and of a superior articular process of a vertebra which is below the disc.

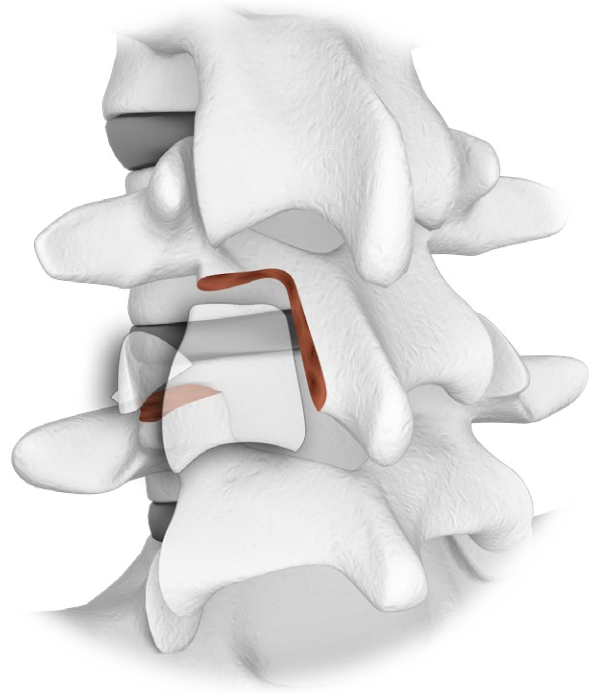

## IV.3. INSERTION OF TRANSPEDICULAR SCREWS FROM CHARSPINE2 SYSTEM (OPTIONAL)



Rod stabilization with the use of transpedicular screws CHARSPINE2 increases the stability of the operated spine segment. Insertion of screws at this stage allows for intraoperative vertebrae distraction (IV.4 of the Instructions) to facilitate the TLIF procedure. It is also possible to insert the screws after the intervertebral cage insertion (IV.10 of the Instructions).

The screws are to be inserted into the contiguous vertebrae situated above and below the damaged intervertebral disc on the left and right side, according to the surgical technique no. 63 CHARSPINE2 SPINE STABILIZATION by ChM.

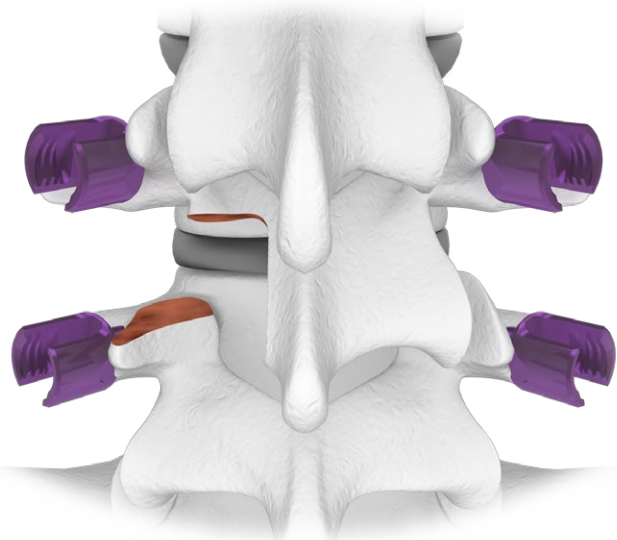

## IV.4. DISTRACTION (OPTIONAL)



Distraction can facilitate the subsequent steps of TLIF intervertebral cage insertion.

Distraction is performed with the use of previously introduced transpedicular screws (IV.3 of the Instructions) and parallel distraction forceps [40.8093] with distraction forceps - jaws [40.5812.000] attached.



40.5812.000

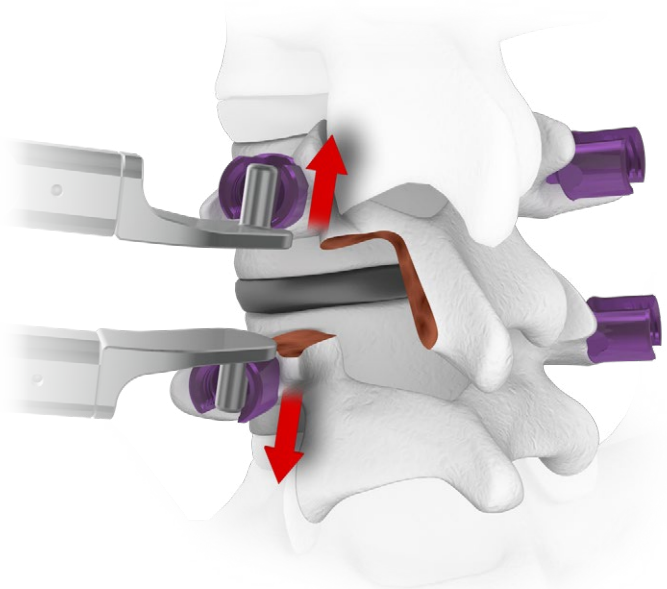

Parallel distraction forceps [40.8093] are additional equipment provided in instrument set [15.0908.201].

When CHARSPINE2 system has been used for the transpedicular stabilization, the forceps are standard equipment of the stabilizer.

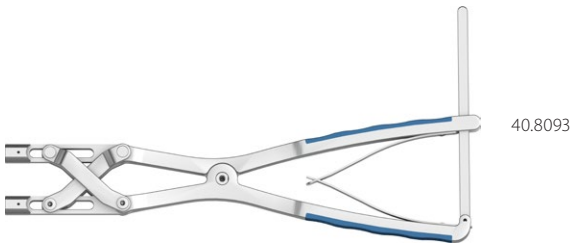

40.8093

## IV.5. DISCECTOMY

The procedure of discectomy begins with preparation of an oval incision (about 1 cm in length) in the anulus fibrosus, below the vertebral pedicle (via previously prepared window).

With the help of Kerrison bone rongeur [40.7086], bone curettes [40.6200], [40.6201] or reamers [40.5805], through the prepared incision in the anulus fibrosus, remove the fragments of intervertebral disc and leave the outer part of anulus fibrosus. It prevents the bone graft from migration, facilitates insertion and stabilizes the implant position.



40.7086

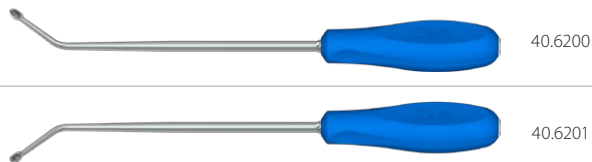

40.6200

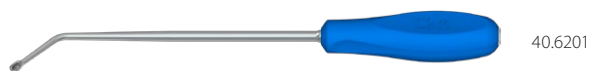

40.6201



40.5805



Files, bone curette, osteotomes and rongeurs are additional equipment provided in instrument set [15.0904.102].

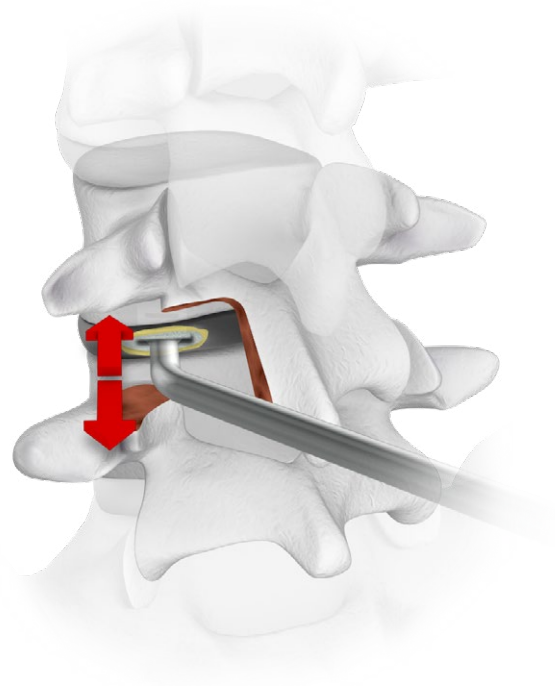
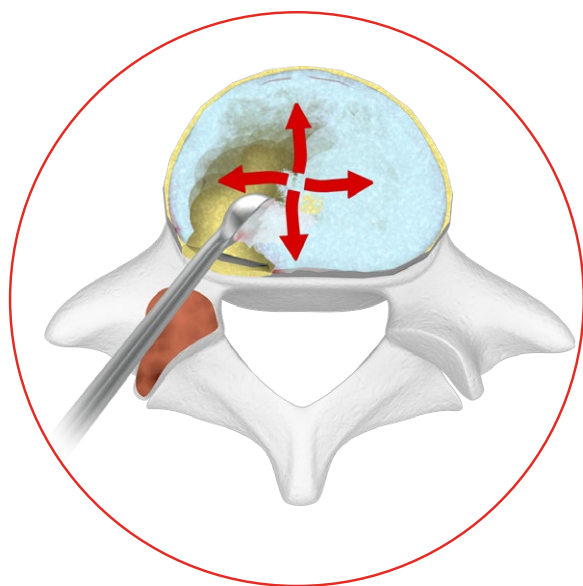



## IV.6. PREPARATION OF THE ENDPLATE SURFACES OF VERTEBRAL BODIES



An appropriate surgical preparation of the surfaces of vertebral bodies adjacent to the removed intervertebral disc is necessary for achieving proper spondylosis.

With the aid of the file [40.6197] or bone curette rectangular right [40.6194] and left [40.6195], remove the cartilaginous surface (that remains after removed intervertebral disc) and the subchondral bone layer until the bleeding bone is exposed.



40.6197



40.6194



40.6195

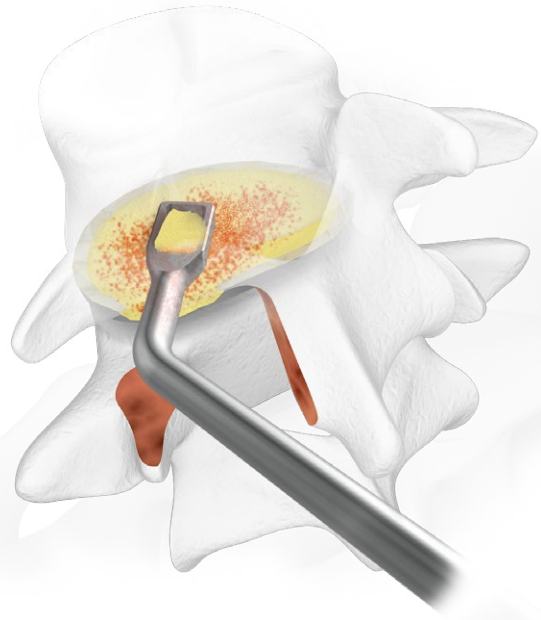
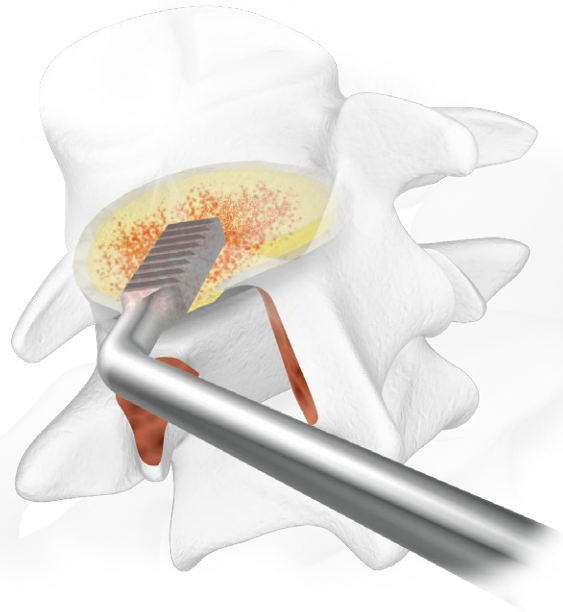

Files, bone curette, osteotomes and rongeurs are additional equipment provided in instrument set [15.0904.102].



Excessive removal of the subchondral bone weakens the boundary surface of the vertebral body which may lead to its collapse, resulting in loss of stability of the operating spine section after surgery.

## IV.7. IMPLANT SIZE SELECTION

The size of an implant (*height, width*) is selected with the aid trials: **[40.8206.xxx]** or **[40.8205.xxx]** or **[40.6128.xxx]**.  
Use the persuader **[40.6217]** for trials insertion.



40.6217

Both elements are connected by inserting the tip of persuader into the trial socket and locking the connection by rotating the knob located over the handle clockwise.

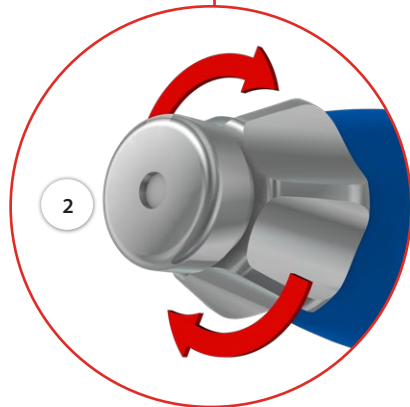
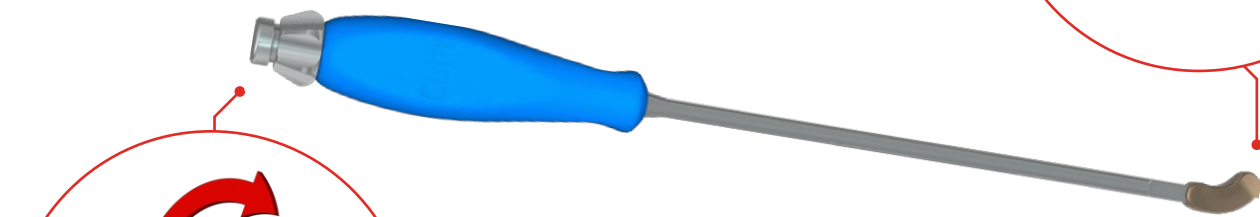
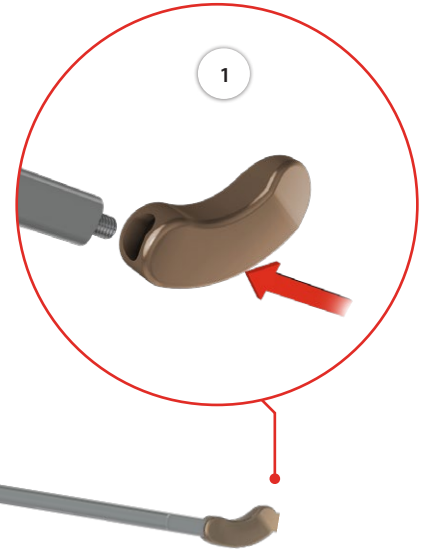

The trials are inserted into the intervertebral space starting with the smallest size (7x26) up to the size when the trial fits tightly and precisely the intervertebral space. The size of a trial corresponds to the size of an implant to be used in the surgery.

To facilitate the trial insertion, the impactor-extractor **[40.6209.000]** can be used. Install the instrument on the persuader and applying downward dynamic movement of the device, insert the trial.



40.6209

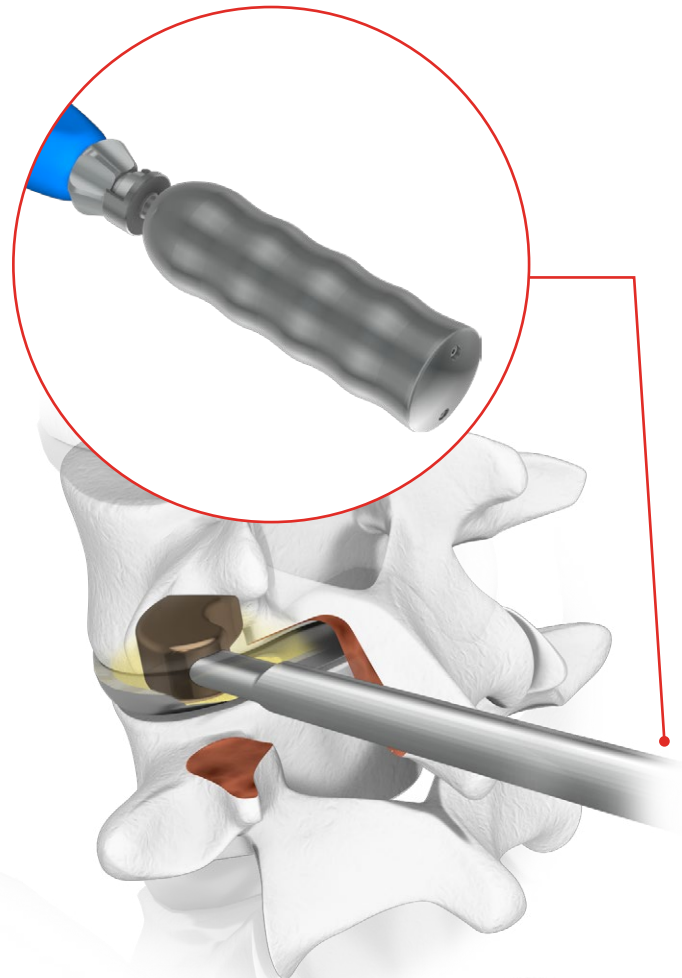

## IV.8. IMPLANT AND APPLICATOR ASSEMBLY

Insert the applicator pin into the connector of intervertebral cage and by rotating the knob clockwise, secure the pin in the cage until slight resistance is felt (*do not tighten up*).

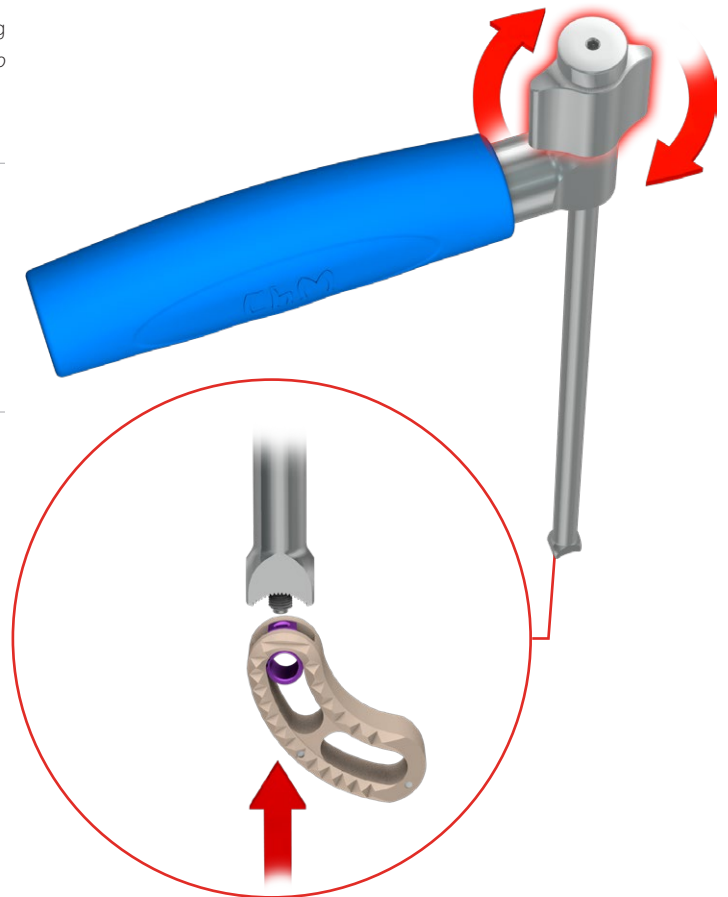
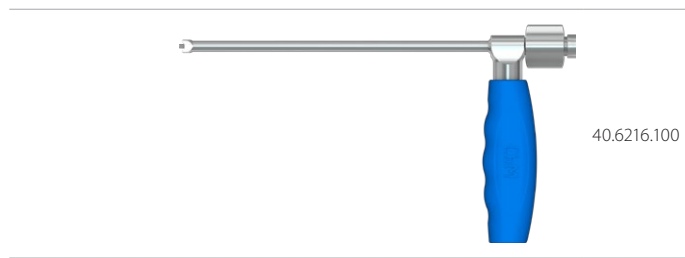

Put the implant maximally upright and lock it in this position by rotating the knob in a clockwise direction. Do not tighten up.

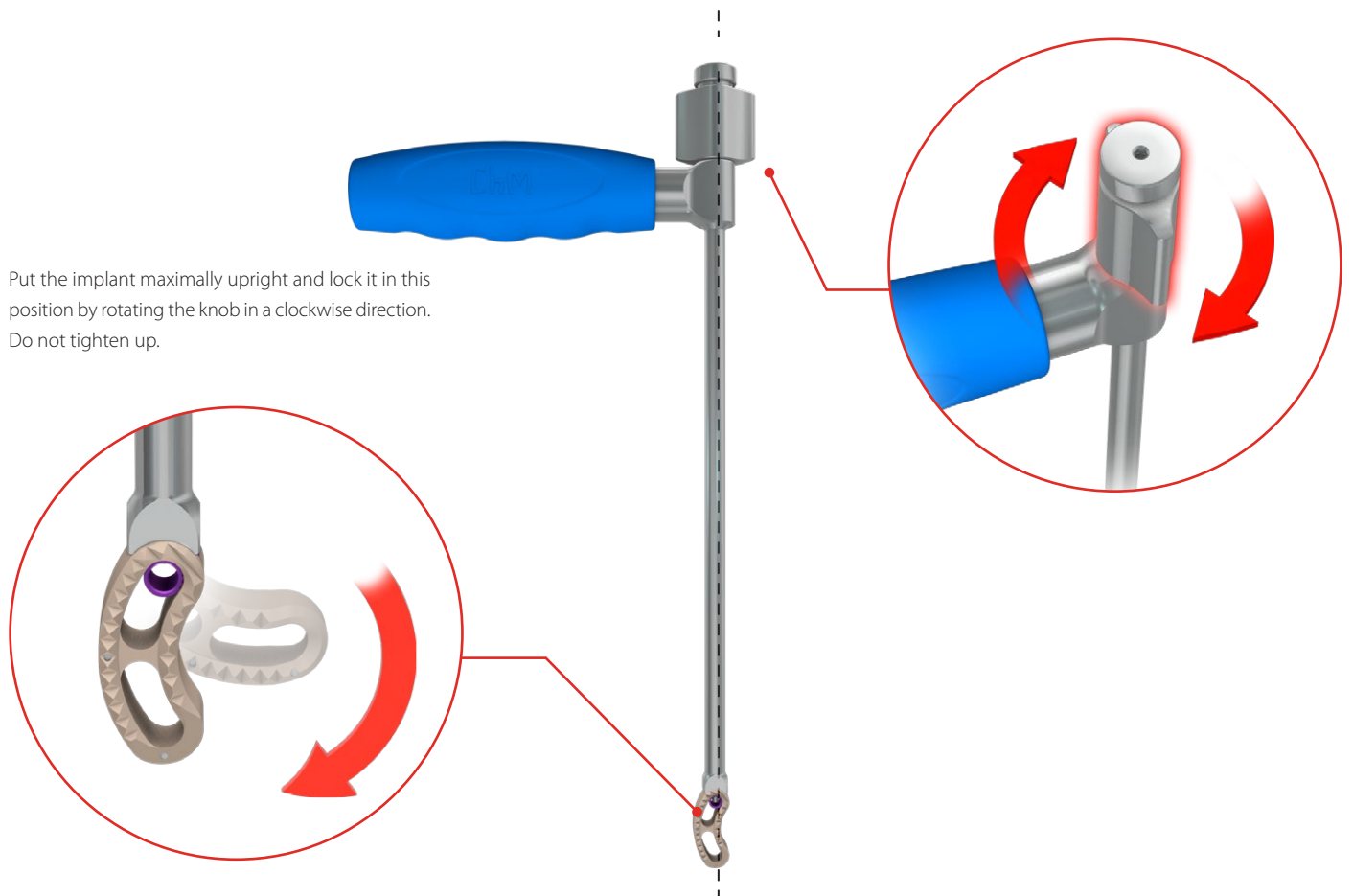

For PEEK implants, fill in the implant's empty space with autologous bone chips, as described below:

1. Put the intervertebral cage locked in the applicator into one of the sockets of the working stand **[40.6208]** (corresponding to the implant size).
2. Fill in the empty space with bone chips, compressing them with the help of compactor **[40.6218]** until the compressed material levels with the upper surface of the implant.

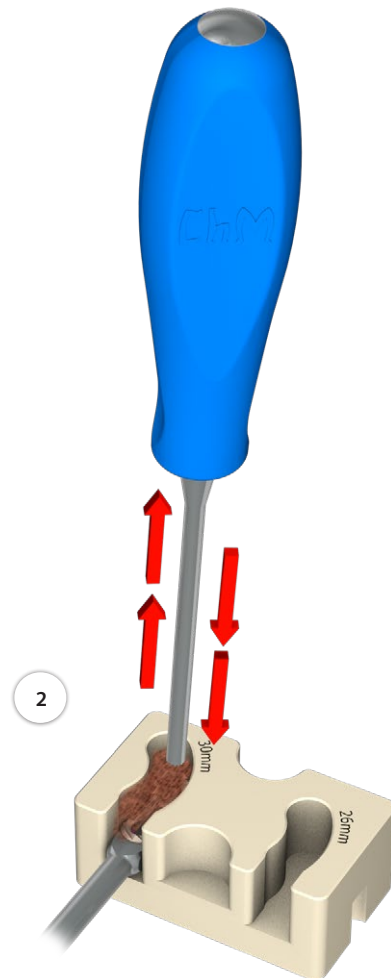
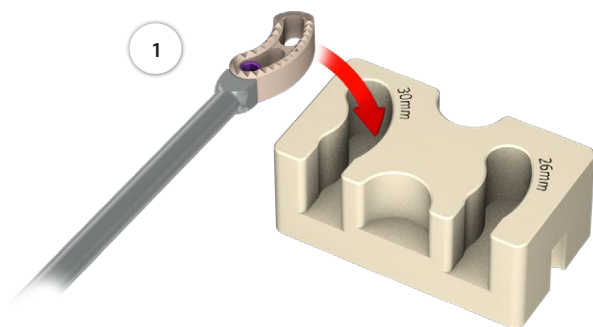
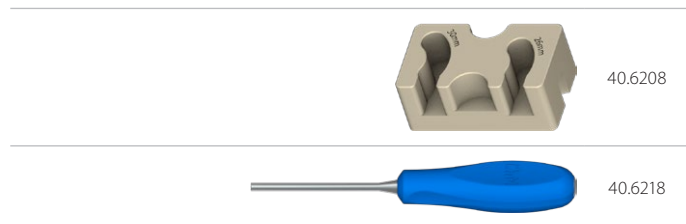

## IV.9. INSERTION OF INTERVERTEBRAL CAGE



The intervertebral cage is to be inserted through the incision made in the intervertebral disc during the discectomy. To facilitate the implantation, retain the previously prepared vertebrae distraction.



At this stage, the implant should be locked in maximally upright position (as in section IV.3).

During the insertion of intervertebral cage, it is necessary to retain the angle of about 15° between the applicator tip and the axis of symmetry of the vertebra visible in the transverse plane.

During the first stage, carefully and gradually put the implant into the intervertebral space until its end reaches the internal frontal part of anulus fibrosus.



Take X-Ray image to establish the precise position of the implant.

To release the angular lock of the implant, rotate the knob of the applicator in a counter-clockwise direction by  $\frac{1}{4}$  up to  $\frac{1}{2}$  of rotation.

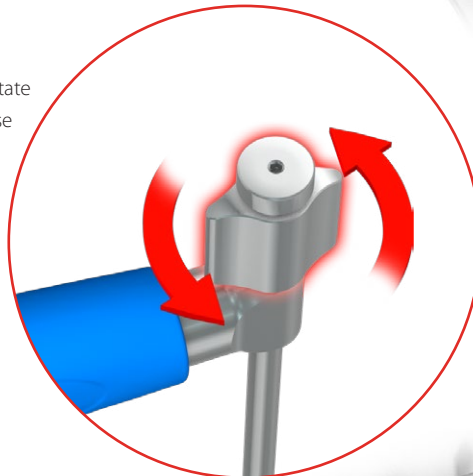

After the lock release, the cage automatically positions itself appropriately for TLIF.

If any correction of the implant position is necessary, the implant should be locked again in appropriate angular position by rotating the knob clockwise.

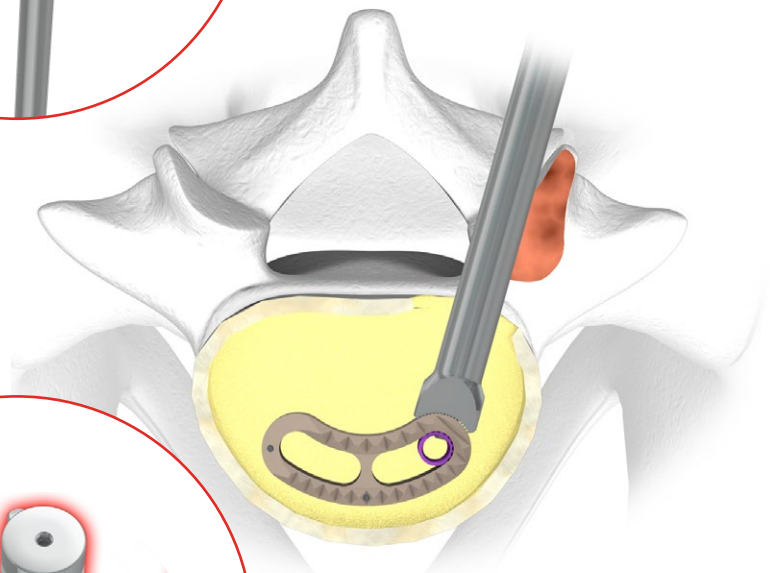
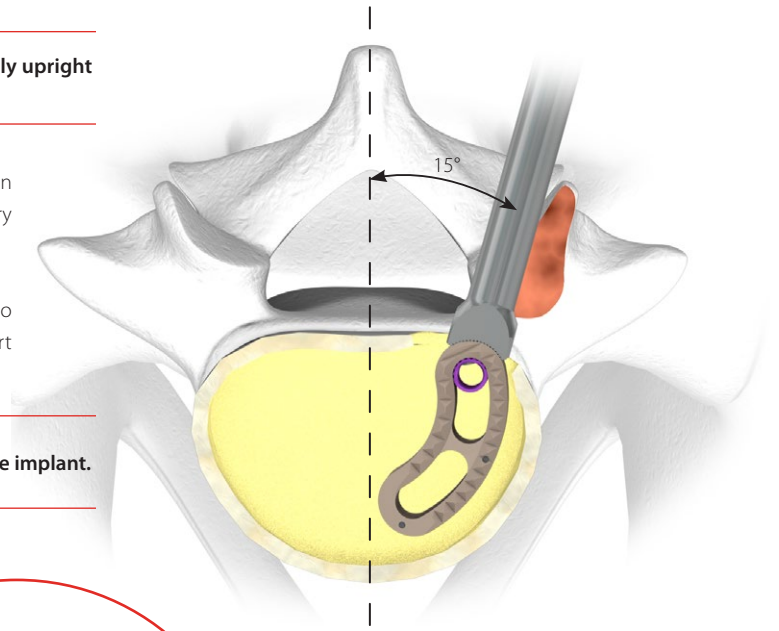
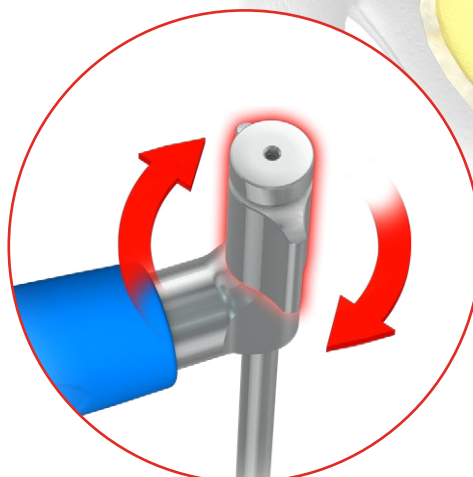



Take X-Ray image to establish the precise position of the implant.

The position of the implant made of PEEK is determined by two radiological markers and titanium connector embedded in the implant, which are visible in the imaging examination.

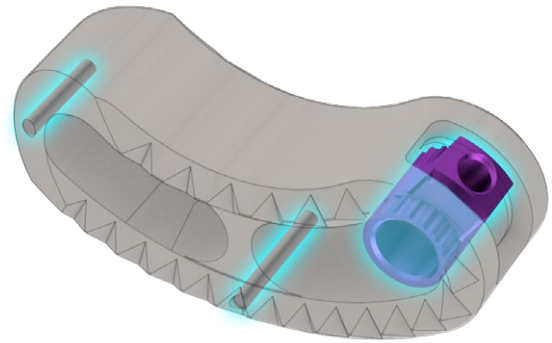

**Correct implant position.**  
The shorter marker is at the height of the cage connector.

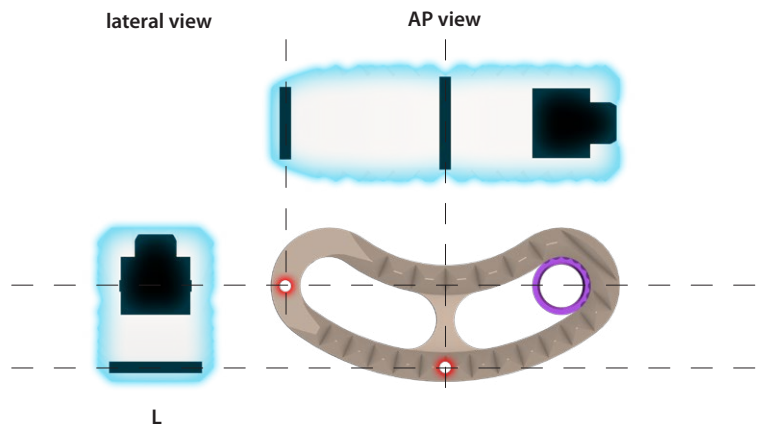

**Acceptable implant position.**  
The shorter marker is located between the cage connector and the longer marker.

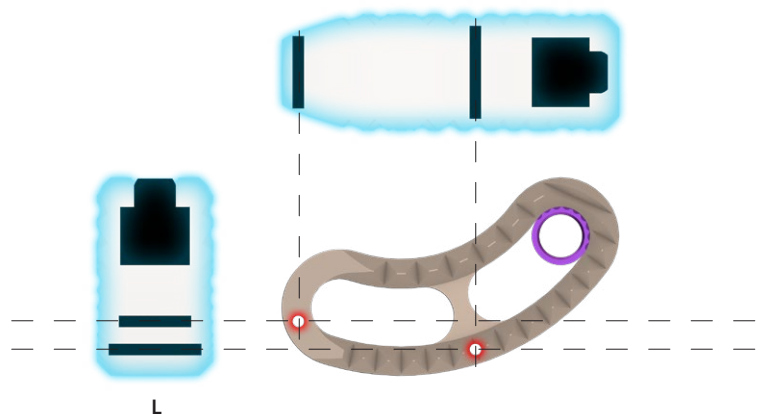

**Incorrect implant position!**  
The shorter marker is below the longer marker.

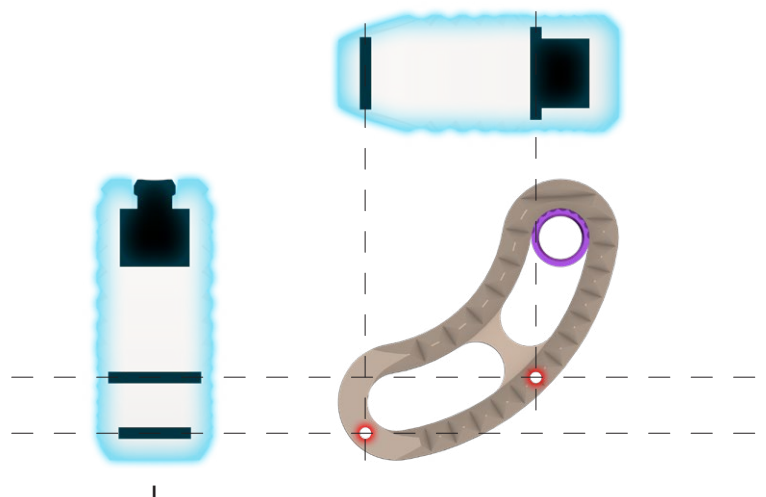

Use the impactor-extractor **[40.6209]** to facilitate the insertion of intervertebral cage.

Connect this device with the applicator by inserting the impactor-extractor handle into the cut in the upper knob of the applicator. The implant is impacted into the intervertebral space by a downward dynamic movement of the butt.



40.6209

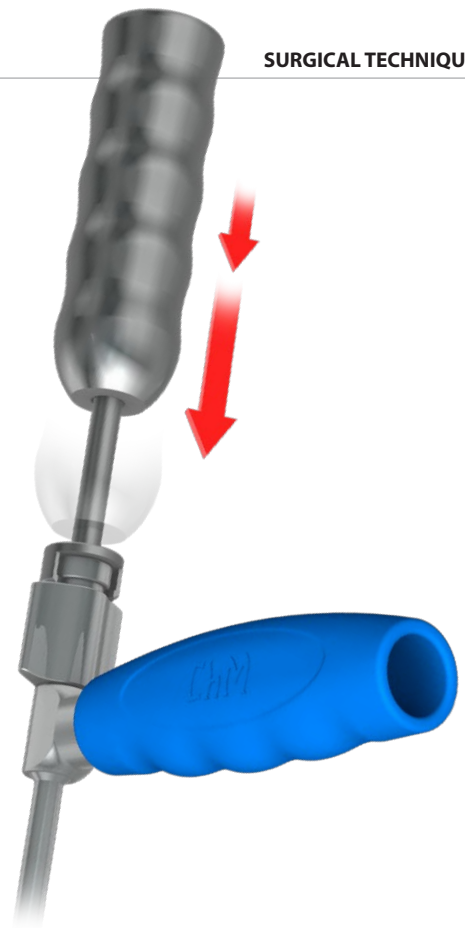

To detach the applicator from the intervertebral cage, remove completely the locking pin from the cage connector by counterclockwise rotation (*about four full turns*).

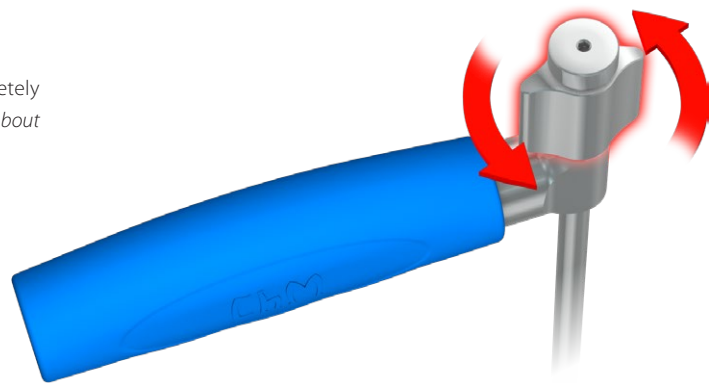

At this stage, small corrections of implant positioning may be introduced by careful impacting the implant in a desired direction with the use of the impactor **[40.6219]**.



40.6219

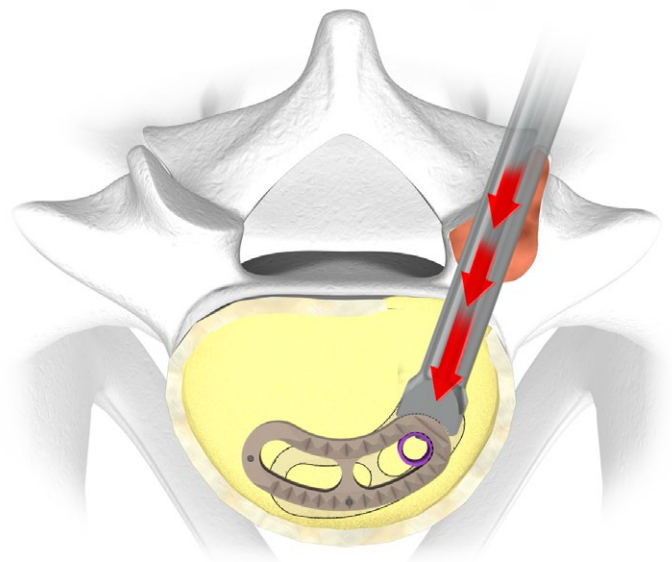

After correct implant insertion, the remaining intervertebral space should be filled with autologous bone graft (*bone chips*).

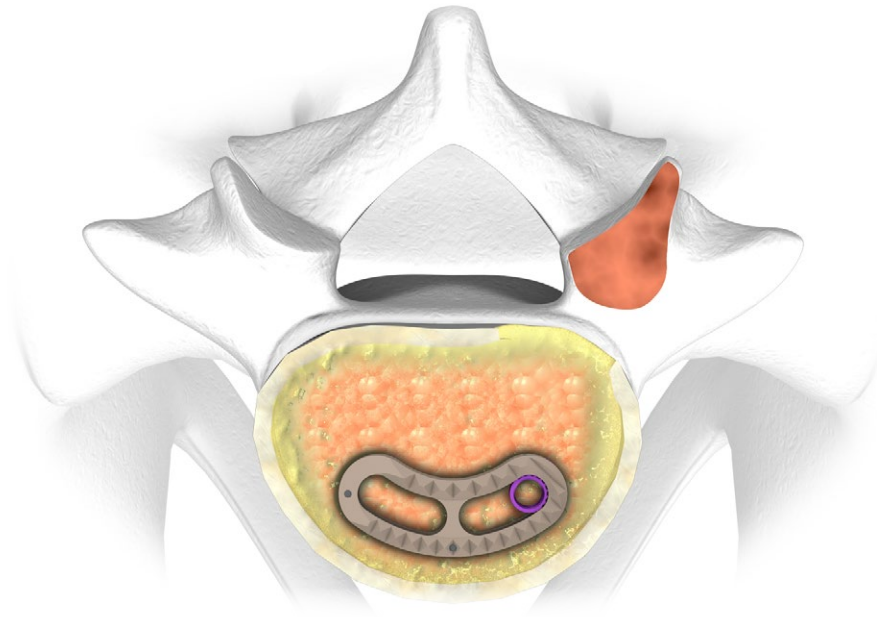

#### IV.10. TRANSPEDICULAR STABILIZATION

Transpedicular stabilization shall be performed with the use of transpedicular screws made by **ChM** and in accordance with the surgical technique no. 63 SPINE STABILIZATION.

If the transpedicular screws were not inserted before (*see section IV.3 of the Instructions*), they should be introduced now on both sides into the vertebral pedicles below and above the damaged intervertebral disc.

Further procedures are to be performed according to the surgical technique for transpedicular screws by **ChM**.



**According to the surgical technique for transpedicular stabilization with the screws, it is recommended to perform a gentle compression of the vertebrae.**

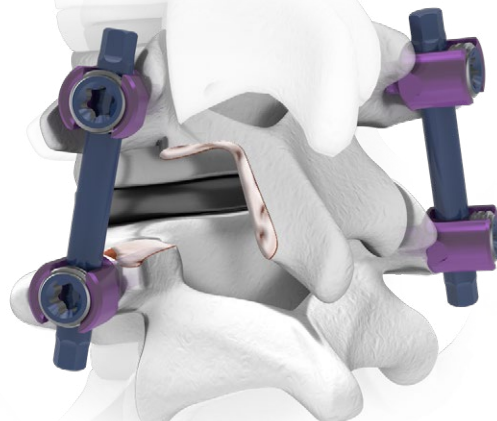



## IV.11. IMPLANT REMOVAL

In order to remove (if necessary) the TLIF cage, the vertebrae distraction is required.

Distraction may be performed directly with the use of reamers [40.5825.xxx] or optionally with the use of previously introduced transpedicular screws and parallel distraction forceps [40.8093] (available in the instrument set for CHARSPINE2 spine stabilization or in the additional instrument set [15.0908.201]) which are equipped with distraction forceps - jaws [40.5812.000].



40.5805.xxx



40.5812.000

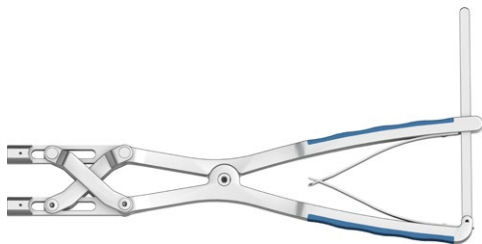

40.8093

After the vertebrae distraction, locate the threaded connector of intervertebral cage and screw the applicator pin [40.6216.100] into it.

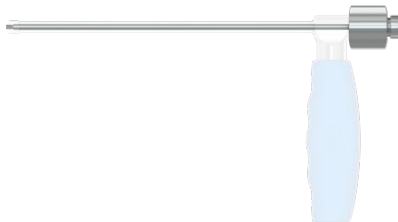

40.6216.100

Next insert the impactor-extractor [40.6209] handle into the cut on a pin knob and by moving the butt upwards and downwards, carefully extract the implant from the intervertebral space.



40.6209

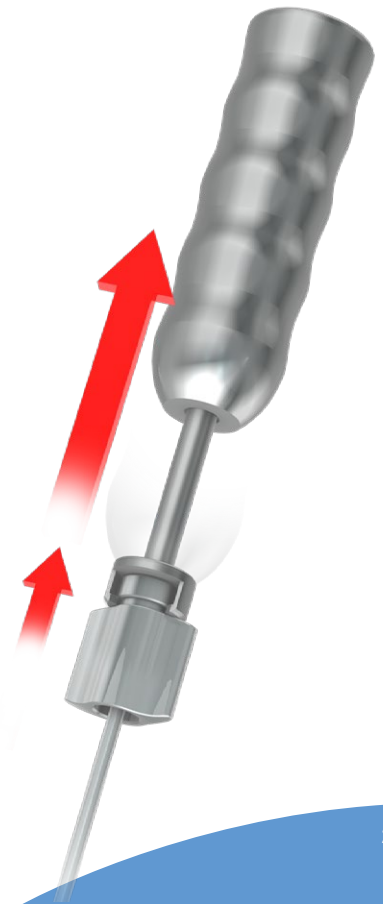
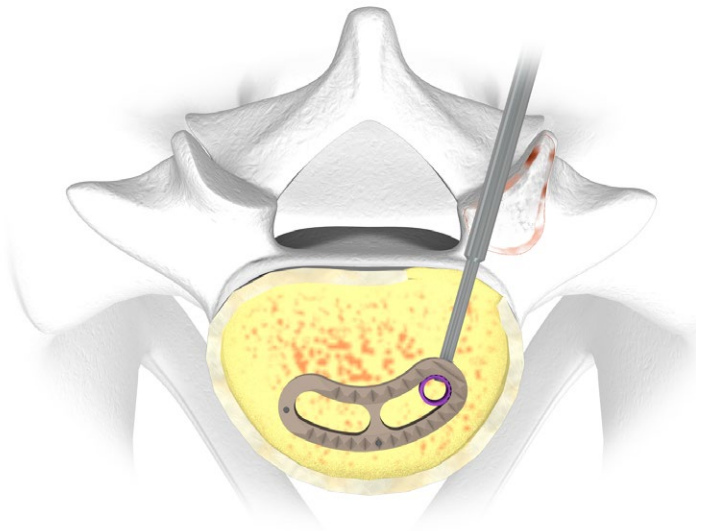
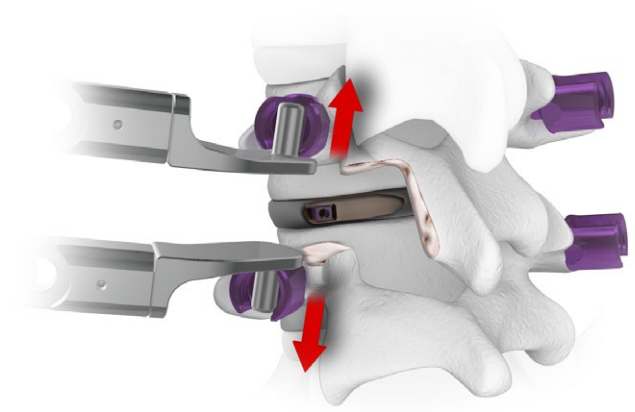





**ChM sp. z o.o.**

Lewickie 3b  
16-061 Juchnowiec Kościelny  
Poland

tel. +48 85 86 86 100

fax +48 85 86 86 101

chm@chm.eu

www.chm.eu



CE 0197