

CHM[®]

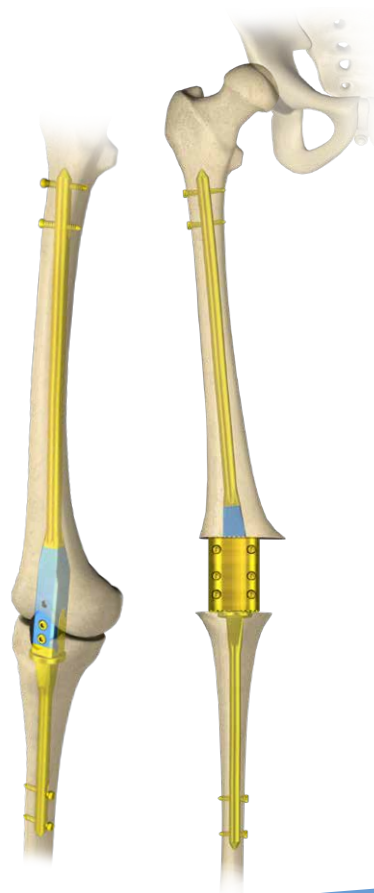









CHARFIX *system 2*









CHARFIX2 FN NAIL

- *IMPLANTS*
- *INSTRUMENT SET 15.0427.100*
- *SURGICAL TECHNIQUE*



SYMBOLS DESCRIPTION

	Pure titanium
	Titanium alloy
	Steel
	Left
	Right
	Available versions: left/right
	Length
	Torx drive
	Torx drive cannulated
	Hexagonal drive
	Hexagonal drive cannulated

	Cannulated
	Locking
	Diameter
	Inner diameter
	Recommended length range for a particular nail
	Angle
	Available lengths
	Available in sterile/ non- sterile condition



Caution - pay attention to a special procedure.



Perform the activity under X-Ray control.



Information about the next stages of a procedure.



Proceed to the next stage.



Return to the specified stage and repeat the activity.



Before using the product, carefully read the Instructions for Use. It contains, among others, indications, contraindications, side effects, recommendations and warnings related to the use of the product.



The above description is not a detailed instruction of conduct. The surgeon decides about choosing the operating procedure.

www.chm.eu

Document No ST/69A
 Date of issue 21.01.2016
 Review date P-007-18.08.2023

The manufacturer reserves the right to introduce design changes.
 Updated INSTRUCTIONS FOR USE are available at the following website: ifu.chm.eu

I. INTRODUCTION	5
II. IMPLANTS	6
III. INSTRUMENT SET	11
IV. SURGICAL TECHNIQUE	14
IV.A. WITHOUT KNEE RESECTION	14
IV.A.1. PATIENT POSITIONING	14
IV.A.2. SURGICAL APPROACH	14
IV.A.3. INSERTION OF CHARFIX2 FN NAIL - TIBIA	15
IV.A.4. INSERTION OF CHARFIX2 FN NAIL - FEMUR	26
IV.A.5. JOINING CHARFIX2 FN NAIL - FEMUR AND CHARFIX2 FN NAIL - TIBIA	29
IV.A.6. CHARFIX2 FN NAIL - FEMUR - DISTAL LOCKING	30
IV.A.7. IMPLANT REMOVAL	32
IV.B. WITH KNEE RESECTION	33
IV.B.1. PATIENT POSITIONING	33
IV.B.2. SURGICAL APPROACH	33
IV.B.3. KNEE RESECTION	33
IV.B.4. INSERTION OF CHARFIX2 FN NAIL - TIBIA	34
IV.B.5. INSERTION OF CHARFIX2 FN NAIL - FEMUR	45
IV.B.6. JOINING CHARFIX2 FN NAIL - FEMUR AND CHARFIX2 FN NAIL - TIBIA	50
IV.B.7. CHARFIX2 FN DISTANCE INSERTION AND CHARFIX2 FN NAIL - FEMUR LOCKING	51
IV.B.8. NAIL LOCKING USING "FREE-HAND TECHNIQUE"	57
IV.B.9. IMPLANT REMOVAL	58

I. INTRODUCTION

CHARFIX2 FN Nail is used to join femur and tibia at the site of the knee resection or partially removed joint surfaces. The implant is a compound system which includes the following elements:

- **CHARFIX2 FN** Nail - femur
- **CHARFIX2 FN** Nail - tibia
- **CHARFIX2 FN** Distance
- **CHARFIX2 FN** Screw T

Indications:

- Failed knee arthroplasty
- Post-infection state
- Periprosthetic fractures
- Post-traumatic state excluding knee prosthesis implantation
- Tumors in the knee area
- Loss of or damage to the extensor mechanism
- Oncological changes
- Arthroplasty of the knee joint

The presented range of implants is made of titanium and its alloys in accordance with ISO 5832 standard. Compliance with the requirements of Quality Management Systems and the requirements of Directive 93/42/EEC concerning medical devices guarantee high quality of the offered implants.

II. IMPLANTS

CHARFIX2 FN NAIL - FEMUR RIGHT

CHARFIX *system 2*

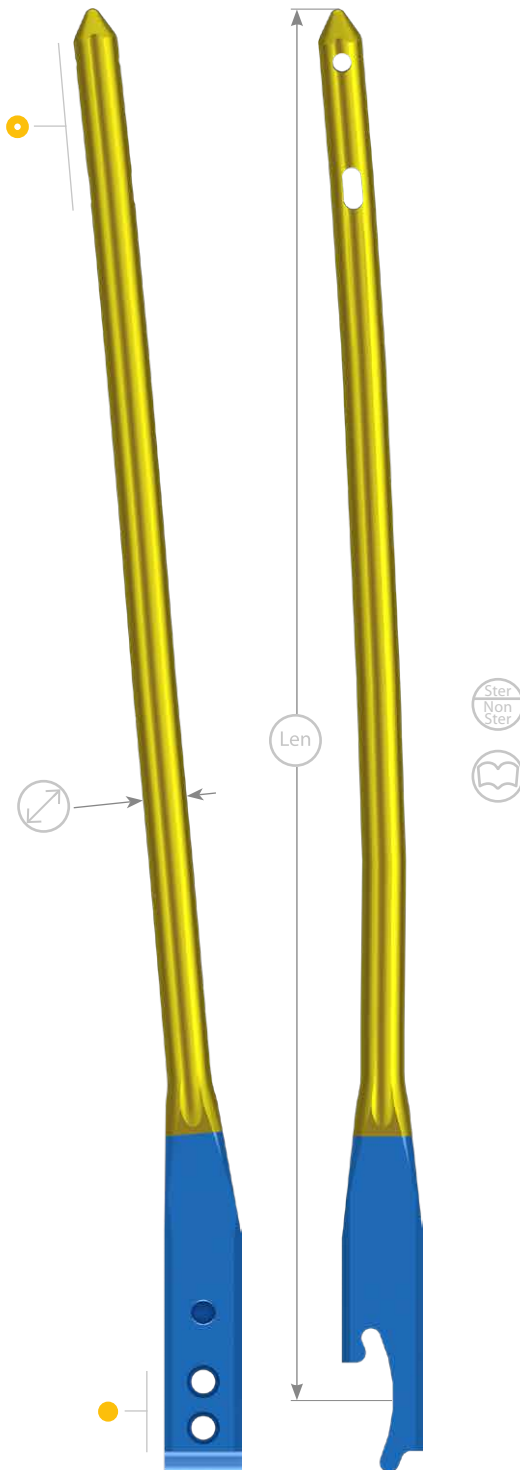
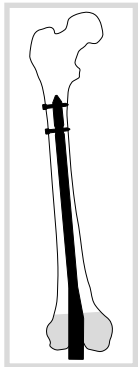

	Len	TiA
10	180	3.6320.180
	200	3.6320.200
	220	3.6320.220
	240	3.6320.240
	260	3.6320.260
	280	3.6320.280
	300	3.6320.300
	320	3.6320.320
	340	3.6320.340
	360	3.6320.360
	380	3.6320.380
	400	3.6320.400
	420	3.6320.420
	440	3.6320.440
	460	3.6320.460
	480	3.6320.480
11	180	3.6322.180
	200	3.6322.200
	220	3.6322.220
	240	3.6322.240
	260	3.6322.260
	280	3.6322.280
	300	3.6322.300
	320	3.6322.320
	340	3.6322.340
	360	3.6322.360
	380	3.6322.380
	400	3.6322.400
12	180	3.6324.180
	200	3.6324.200
	220	3.6324.220
	240	3.6324.240
	260	3.6324.260
	280	3.6324.280
	300	3.6324.300
	320	3.6324.320
	340	3.6324.340
	360	3.6324.360
	380	3.6324.380
	400	3.6324.400
420	3.6324.420	
440	3.6324.440	
460	3.6324.460	
480	3.6324.480	



	R
10	
11	
12	

	TiA				
3.5159.xxx	✓	5.0	26±100	●	
3.6300.000	✓			●	



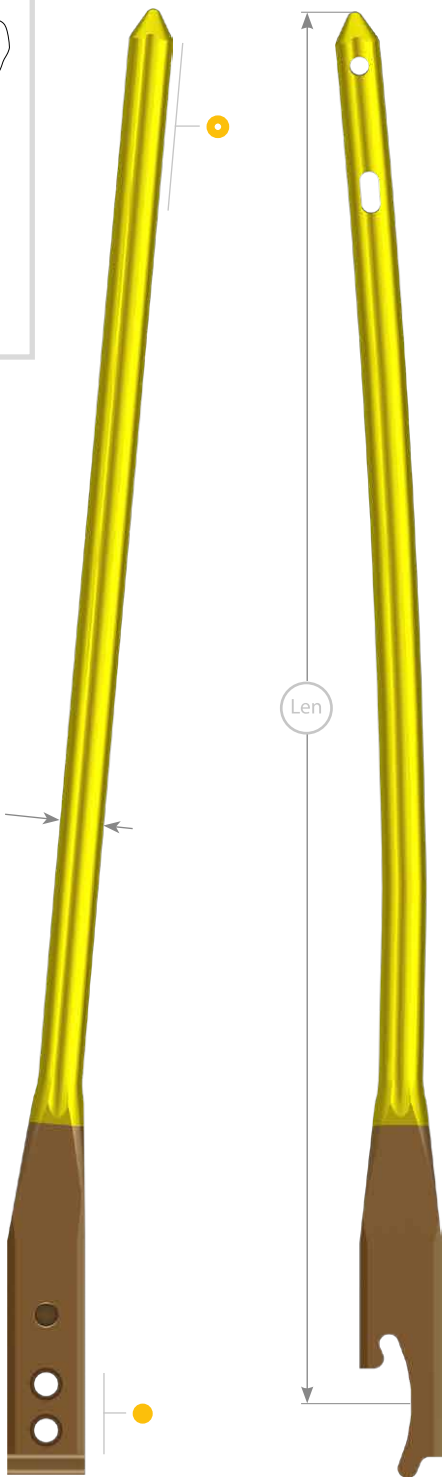
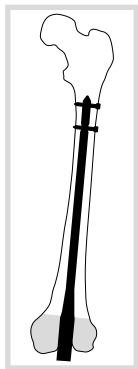

available		8 mm ÷ 19 mm	1 mm
			pitch
		180 mm ÷ 480 mm	20 mm

CHARFIX2 FN NAIL - FEMUR LEFT



		Len	
10		180	3.6319.180
		200	3.6319.200
		220	3.6319.220
		240	3.6319.240
		260	3.6319.260
		280	3.6319.280
		300	3.6319.300
		320	3.6319.320
		340	3.6319.340
		360	3.6319.360
		380	3.6319.380
		400	3.6319.400
		420	3.6319.420
		440	3.6319.440
		460	3.6319.460
		480	3.6319.480
11		180	3.6321.180
		200	3.6321.200
		220	3.6321.220
		240	3.6321.240
		260	3.6321.260
		280	3.6321.280
		300	3.6321.300
		320	3.6321.320
		340	3.6321.340
		360	3.6321.360
		380	3.6321.380
		400	3.6321.400
12		180	3.6323.180
		200	3.6323.200
		220	3.6323.220
		240	3.6323.240
		260	3.6323.260
		280	3.6323.280
		300	3.6323.300
		320	3.6323.320
		340	3.6323.340
		360	3.6323.360
		380	3.6323.380
		400	3.6323.400
	420	3.6323.420	
	440	3.6323.440	
	460	3.6323.460	
	480	3.6323.480	

		
10		
11		
12		

	TiA					
 3.5159.xxx	✓			5.0	26÷100	●
 3.6300.000	✓					●

available			8 mm ÷ 19 mm	pitch	1 mm
			180 mm ÷ 480 mm		20 mm

CHARFIX2 FN NAIL - TIBIA

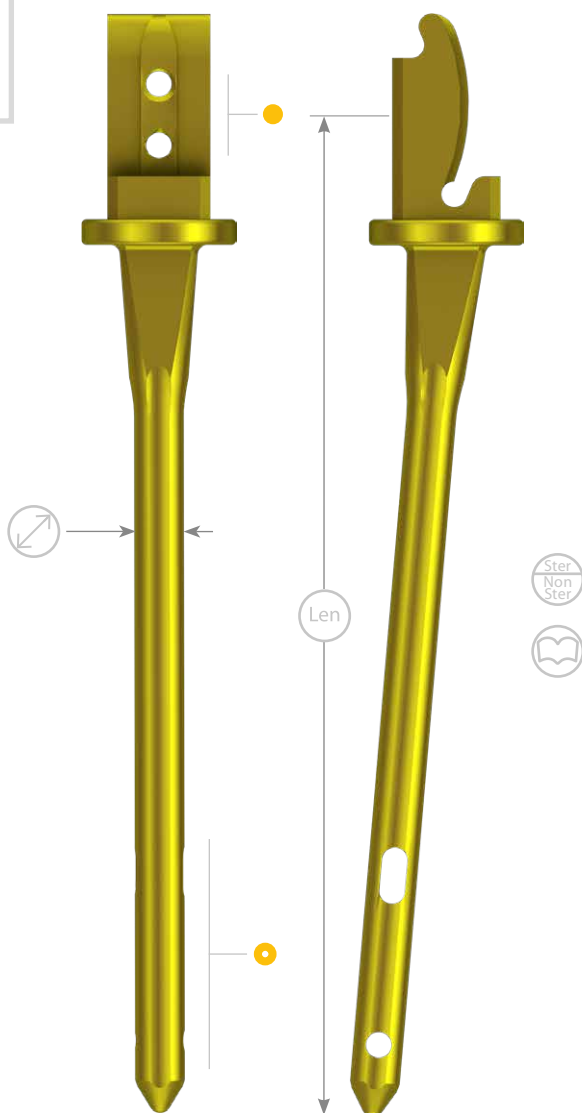
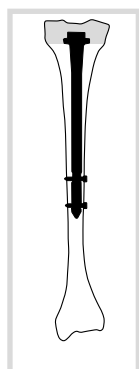

	Len	
10	180	3.6343.180
	200	3.6343.200
	220	3.6343.220
	240	3.6343.240
	260	3.6343.260
	280	3.6343.280
	300	3.6343.300
	320	3.6343.320
	340	3.6343.340
	360	3.6343.360
	380	3.6343.380
	400	3.6343.400
11	420	3.6343.420
	440	3.6343.440
	460	3.6343.460
	480	3.6343.480
	180	3.6344.180
	200	3.6344.200
	220	3.6344.220
	240	3.6344.240
	260	3.6344.260
	280	3.6344.280
	300	3.6344.300
	320	3.6344.320
340	3.6344.340	
360	3.6344.360	
380	3.6344.380	
400	3.6344.400	
420	3.6344.420	
440	3.6344.440	
460	3.6344.460	
480	3.6344.480	
12	180	3.6345.180
	200	3.6345.200
	220	3.6345.220
	240	3.6345.240
	260	3.6345.260
	280	3.6345.280
	300	3.6345.300
	320	3.6345.320
	340	3.6345.340
	360	3.6345.360
	380	3.6345.380
	400	3.6345.400
420	3.6345.420	
440	3.6345.440	
460	3.6345.460	
480	3.6345.480	



10	
11	
12	

	TiA					
3.5159.xxx	✓			5.0	26÷100	
3.6300.000	✓					

available		8 mm ÷ 19 mm	pitch	1 mm
		180 mm ÷ 480 mm		20 mm

LOCKING ELEMENTS

CHARFIX *system 2*



CHARFIX2 FN SCREW T



3.6300.000

CHARFIX2 DISTAL SCREW 5.0



30	3.5159.030
35	3.5159.035
40	3.5159.040
45	3.5159.045
50	3.5159.050
55	3.5159.055
60	3.5159.060
65	3.5159.065
70	3.5159.070
75	3.5159.075
80	3.5159.080
85	3.5159.085
90	3.5159.090





Stand for **CHARFIX2** nail locking elements
(set with box without implants)

40.5058.200

CHARFIX2 FN Distance (non-sterile)

CHARFIX_{system 2}

	TiA 	Number of T-screws (cat. no. 3.6300.000)*
20	3.6367.020	2
25	3.6367.025	2
30	3.6367.030	2
40	3.6367.040	4
50	3.6367.050	4
60	3.6367.060	4
70	3.6367.070	6
80	3.6367.080	6
90	3.6367.090	6
100	3.6367.100	6

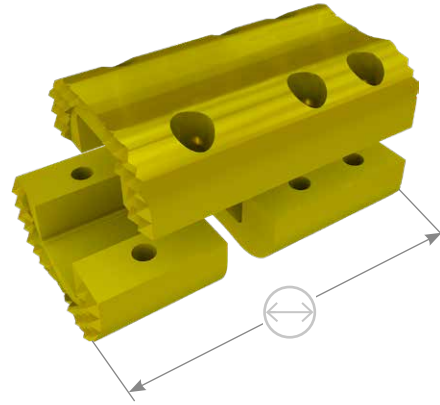

* Not provided with the distance.

INSTRUMENT SET FOR CHARFIX2 FN NAILS











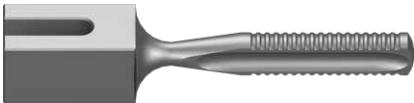





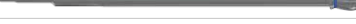

III. INSTRUMENT SET

The instrumentarium set [15.0427.100] is used to join the femur and tibia in the place of knee resection or partially removed joint surfaces. Instruments included in the instrument set are placed on the stands and covered with a cover to facilitate their storage and transportation to the operating theater.

15.0427.100	Name	Pcs	Catalogue No.
	Countersink	1	40.6631.000
	Handle	1	40.6632.000
	Handle	1	40.6633.000
	Targeter arm	1	40.6634.000
	Distal tibial targeter	1	40.6635.000
	Targeter arm	1	40.6636.000
	Distal targeter	1	40.6637.000
	Trial 10	3	40.6638.000
	Trial 20	2	40.6639.000
	Trial 30	2	40.6640.000
	Guide rod handle	1	40.1351.100
	Trocac short 7	1	40.1354.200
	Hole depth measure	1	40.2665.100



INSTRUMENT SET FOR CHARFIX2 FN NAILS

CHARFIX_{system 2}

15.0427.100		Name	Pcs	Catalogue No.
		Mallet	1	40.3667.000
		Guide rod 3.0/580	1	40.3925.580
		Nail length measure	1	40.6641.000
		Aiming insert 9.0	2	40.5065.009
		Wrench S8	1	40.5304.100
		Impactor-extractor	1	40.5507.100
		Cannulated drill 12/3.0	1	40.5314.000
		Protective guide	1	40.5315.100
		Drill with scale 3.5/350	2	40.5339.002
		Drill with scale 3.5/150	1	40.5343.002
		Set block 9/5.0	2	40.5509.200
		Protective guide 9/7	2	40.5510.300
		Drill guide 7/3.5	2	40.5511.300
		Curved awl 8.0	1	40.5523.100
		Screw length measure	1	40.5530.400
		Trocar 6.5	1	40.5534.200
		Screwdriver T25	1	40.5575.300
		Protective guide short	1	40.5871.100
		Drill guide short	1	40.5872.100

INSTRUMENT SET FOR CHARFIX2 FN NAILS

CHARFIX_{system 2}

15.0427.100	Name	Pcs	Catalogue No.
	Perforated aluminum lid 1/1 595x275x15mm Gray	1	12.0750.200
	Stand	1	14.0427.100
	Container with solid bottom 1/1 595x275x185mm	1	12.0750.103

Additionally, to carry out the procedure, the basic equipment for orthopedic procedures is required, such as:

- bone saws
- drive,
- set of flexible intramedullary reamers 8.0÷13.0 mm with guide and handle,
- set of awls, bone curettes,
- set of drill bits,
- Kirschner wires,
- mallets.

IV. SURGICAL TECHNIQUE

Each surgical treatment must be planned carefully. Prior to surgery, appropriate X-Ray images of the affected limb should be taken to determine the pathological changes within the knee joint and the size of the nail to be implanted. AP, PA and lateral X-Ray images are recommended. The implantation procedure should be performed on an operating table equipped with an X-Ray camera.

IV.A. WITHOUT KNEE RESECTION

IV.A.1. PATIENT POSITIONING

The limb should be flexed at 90°.

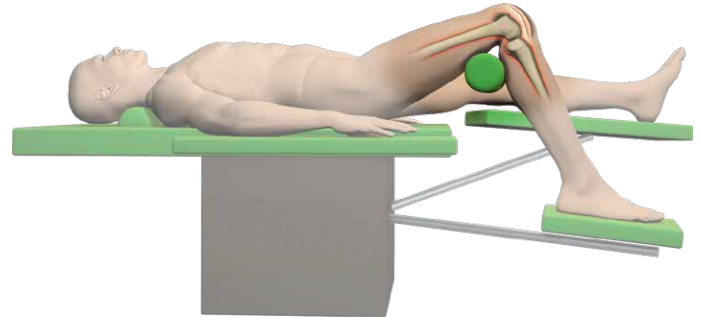

IV.A.2. SURGICAL APPROACH

Make a vertical incision of tissues extending from the region of the femoral condyle to the tibial tuberosity allowing free access to the affected joint.

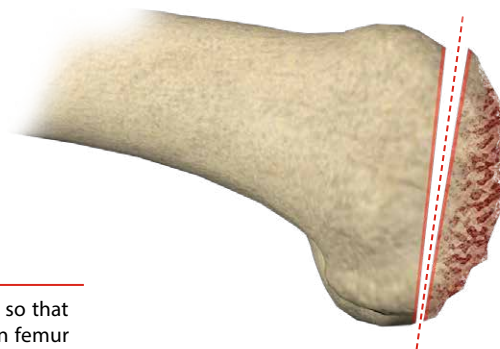
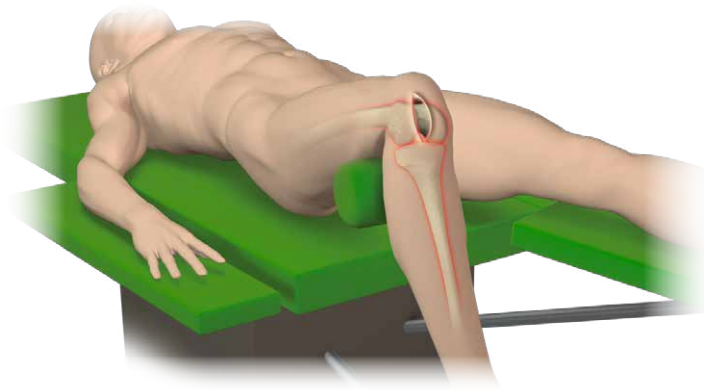

Femorotibial joint surfaces are resected plane-parallel so that sufficient surface contact of vital bone tissue between femur and tibia is achieved.



IV.A.3. INSERTION OF CHARFIX2 FN NAIL - TIBIA

IV.A.3.1. Opening of the medullary canal of the tibia

Use the curved awl 8.0 [40.5523.100] to open the medullary canal.

Attach the guide rod 3.0/580 [40.3925.580] to the guide rod handle [40.1351.100] and using the curved awl, insert into the medullary canal.

Remove the handle and curved awl.

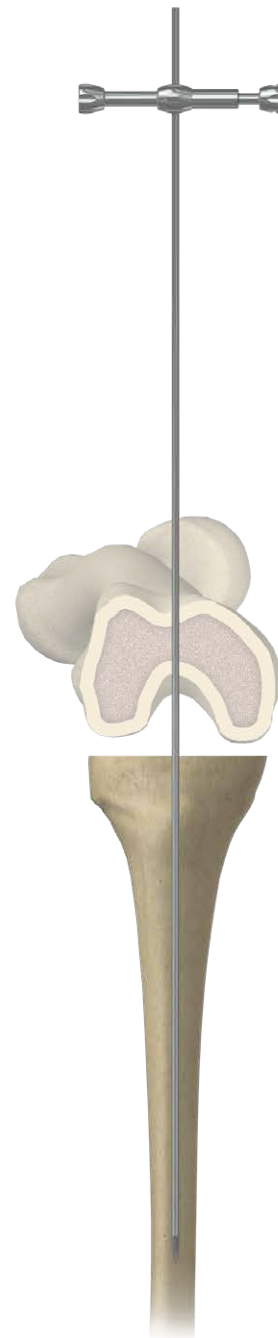
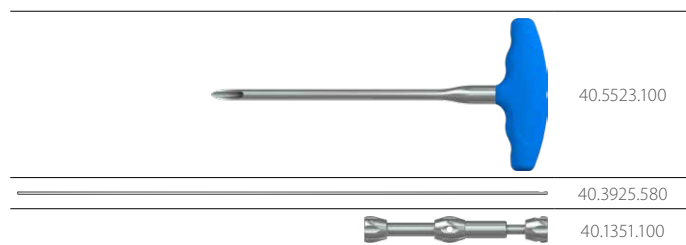

Attach cannulated drill 12/3.0 [40.5314] to a drive and using the protective guide [40.5315.100], deepen the entry point in the medullary canal.

Remove the drill and protective guide.

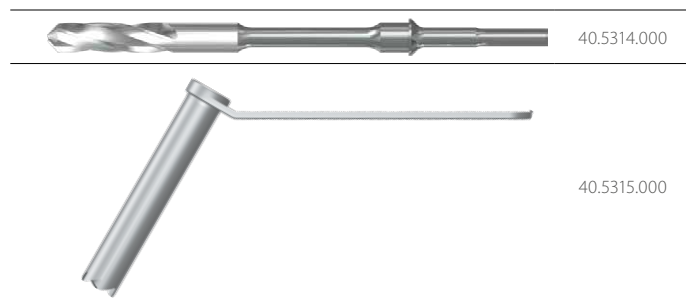

Afterwards, attach a flexible reamer to the drive. Widen the tibial medullary canal gradually until the canal diameter is 1.0 ÷ 1.5mm larger than the diameter of the selected nail.

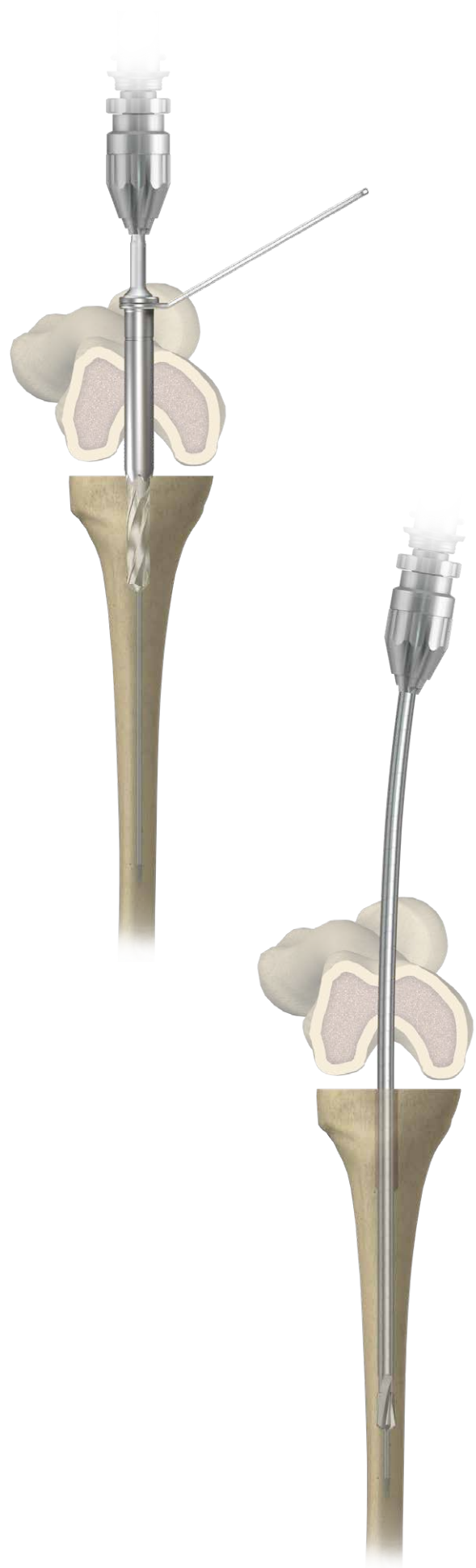

Use the guide rod 3.0/580 [40.3925.580] to introduce the nail length measure [40.6641.000].

Use the scale on the measure described as "Nail length without distance". The beginning of the measure should be placed in the nail entry point on the bone. Read the length of the nail on the scale provided.

Remove the measure and guide rod

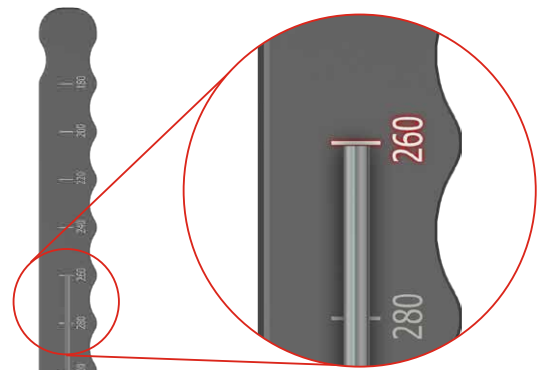

Use countersink [40.6631] to deepen the entry point to the medullary canal.

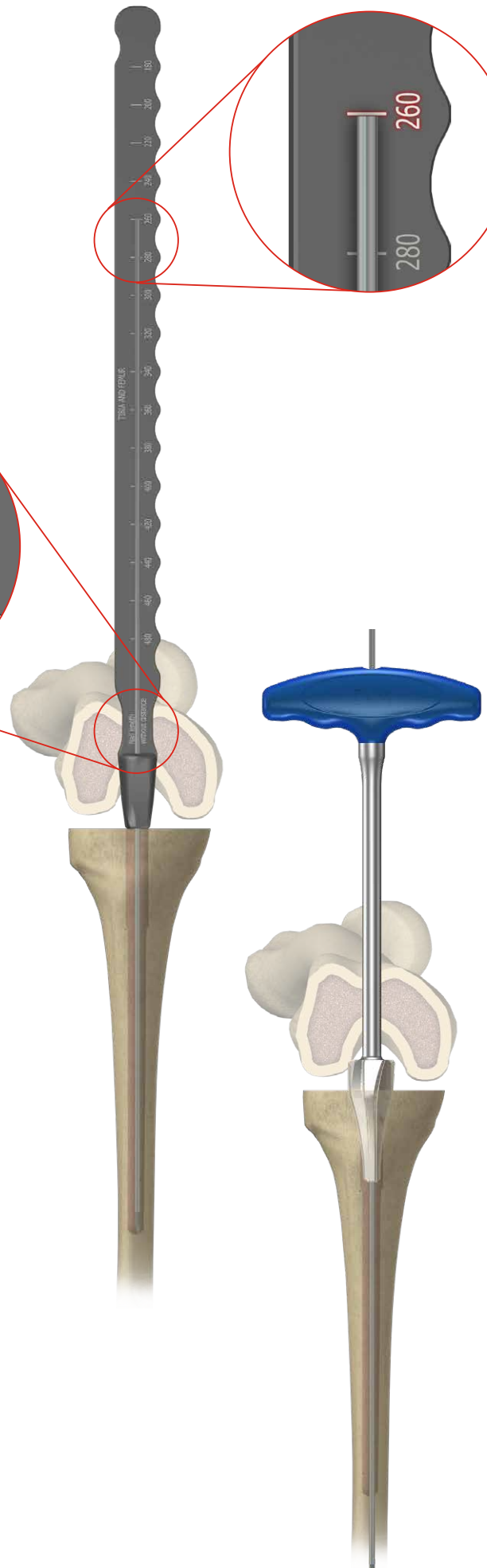
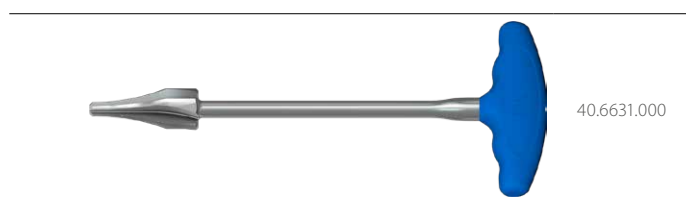

IV.A.3.2. Targeters assembly

The targeter arm [40.6634] can be used with both right and left limb. Use wrench S8 [40.5304.100] to loosen the connecting screw of the targeter arm and rotate the targeter arm connector by 180°.

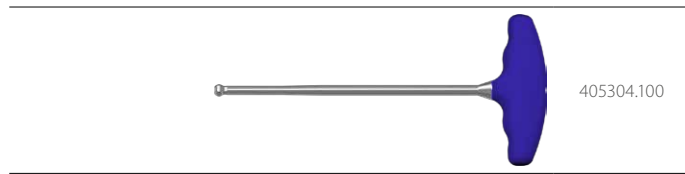

IV.A.3.3. Nail insertion

Prior to nail insertion, determine the position of the distal tibial targeter [40.6635] in relation to the nail holes. For this purpose, attach **CHARFIX2 FN** Nail - tibia to the targeter arm [40.6634] with a wing screw. Afterwards, attach the distal tibial targeter to the targeter arm. Using screwdriver T25 [40.5575.300], loosen the locking screws of a slider (*allowing the slider to move*) and move it near the holes in the distal part of the nail.

Determine the correct position of the targeter slider in relation to the nail holes in the distal part using two set blocks 9/5,0 [40.5509.200]. Lock the targeter slider with the screws using screwdriver T25.

Remove set blocks.

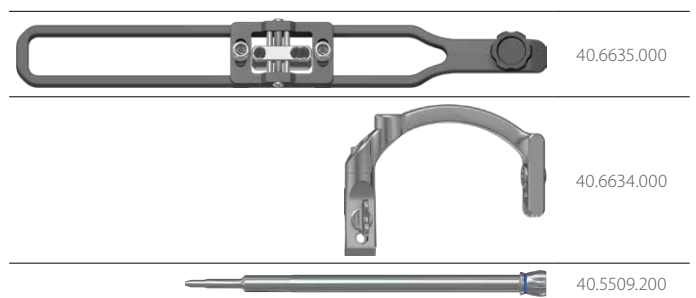

VERIFY: if the targeter slider is properly set and locked, the set blocks should pass through nail holes.

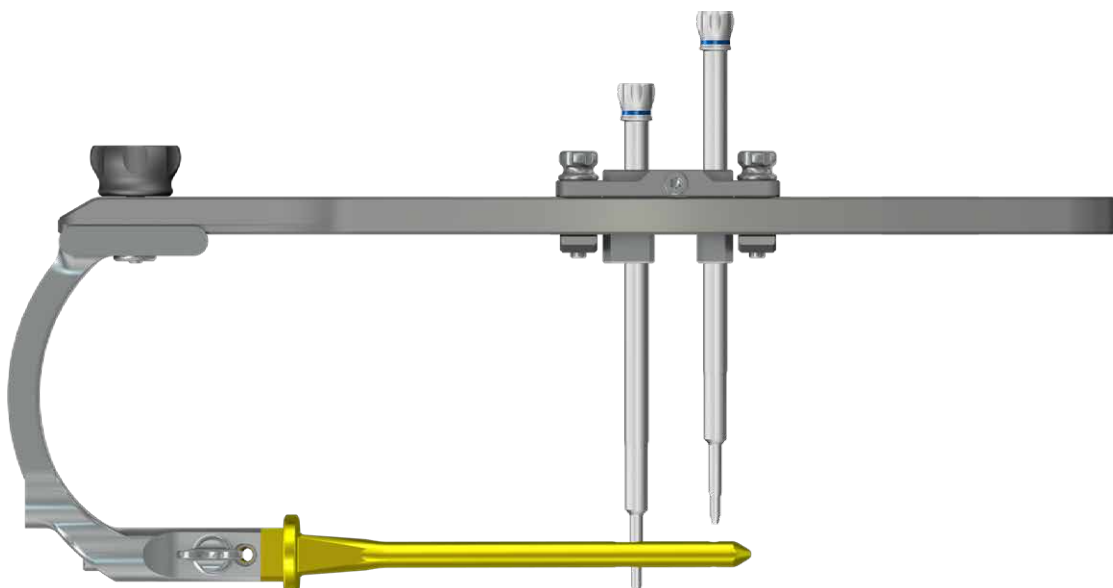

Remove distal tibial targeter [40.6635] from the targeter arm [40.6634]. Attach impactor-extractor [40.5507.100] to the targeter arm. Use the mallet [40.3667] to insert the nail into the tibial medullary canal.

Attach the distal tibial targeter to the targeter arm.

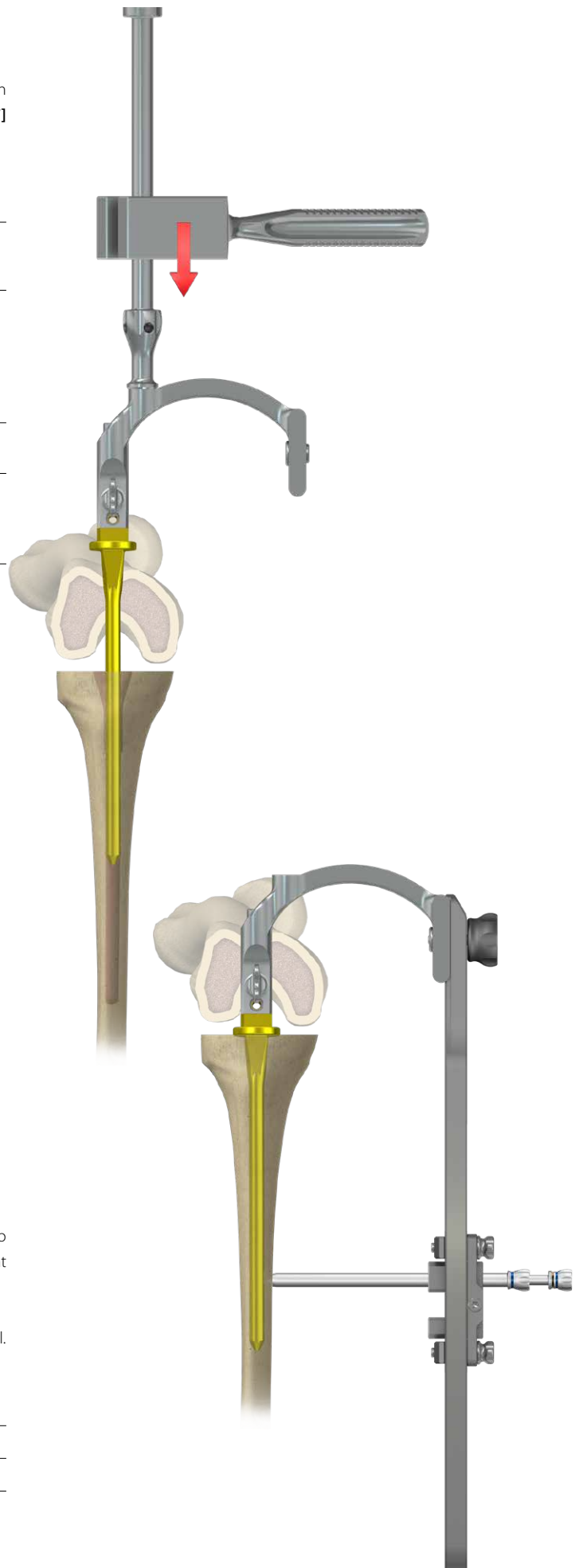
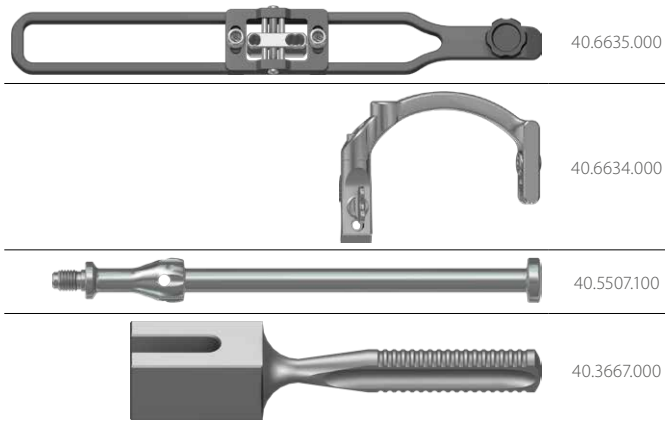

Insert the protective guide 9/7 [40.5510.300] and trocar 6.5 [40.5534.200] into the proximal hole of the distal tibial targeter [40.6635] slider. Mark the entry point for a locking screw on the skin and make an incision of soft tissues.

Push the protective guide and trocar to the bone and mark the entry point for a drill.

Remove the trocar.



Insert the drill guide 7/3.5 [40.5511.300] into the protective guide. Use a drive and the drill with scale 3.5/350 [40.5339.002], guided in the drill guide, to drill a hole in the tibia through both cortical layers and the hole in the nail. The scale on the drill indicates the length of the locking element.

Remove the drive, leave the drill with guides in place.

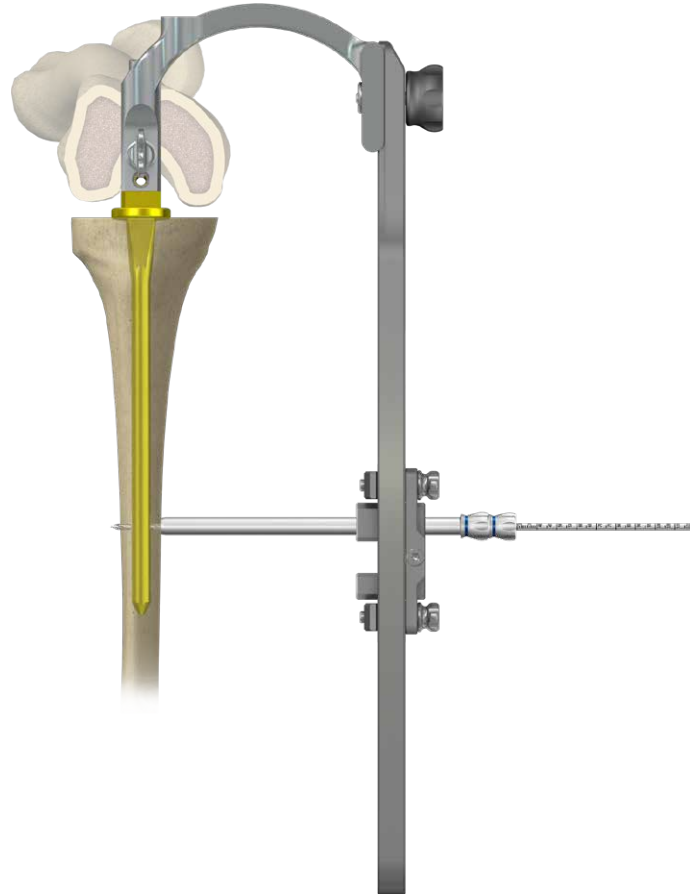

Insert the protective guide 9/7 [40.5510.300] and trocar 6.5 [40.5534.200] into the other hole of the distal tibial targeter [40.6635] slider. Mark the entry point for the locking screw on the skin and make the incision of soft tissues.

Push the protective guide and trocar to the bone and mark the entry point for the drill.

Remove the trocar.

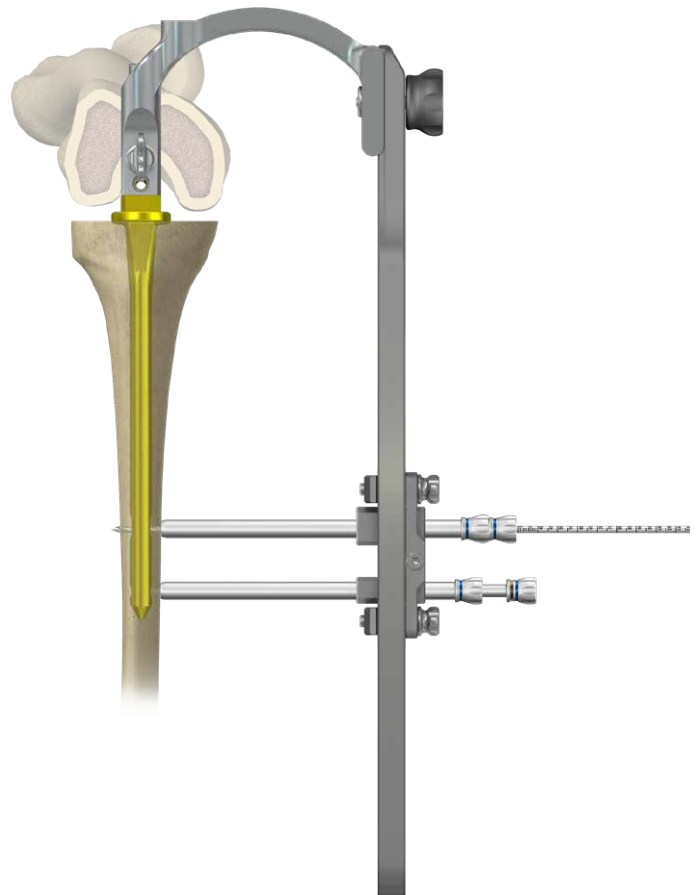
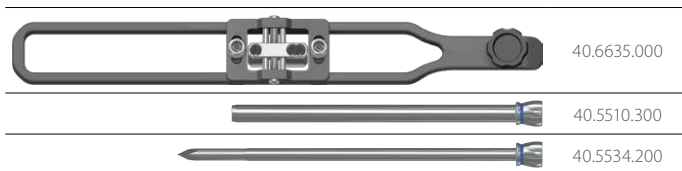

Insert the drill guide 7/3.5 **[40.5511.300]** into the protective guide. Use the drive and the drill with scale 3.5/350 **[40.5339.002]**, guided in the drill guide, to drill a hole in the tibia through both cortical layers and the hole in the nail. The scale on the drill indicates the length of the locking element.

Remove the drill and the drill guide.

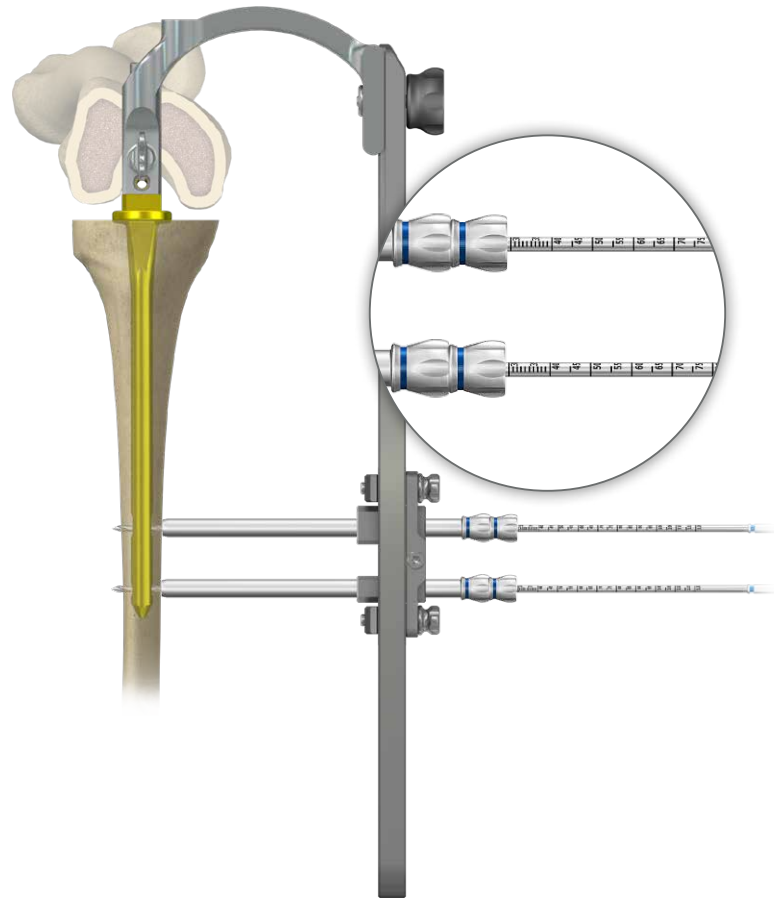

Using the protective guide 9/7 **[40.5510.300]**, insert the screw length measure **[40.5530.400]** into the drilled hole until its hook reaches the "exit" plane of the hole. Read the length of the locking screw on the scale. During measurement, the protective guide should be pressed against the bone.

Remove the screw length measure.

Leave the protective guide in place.

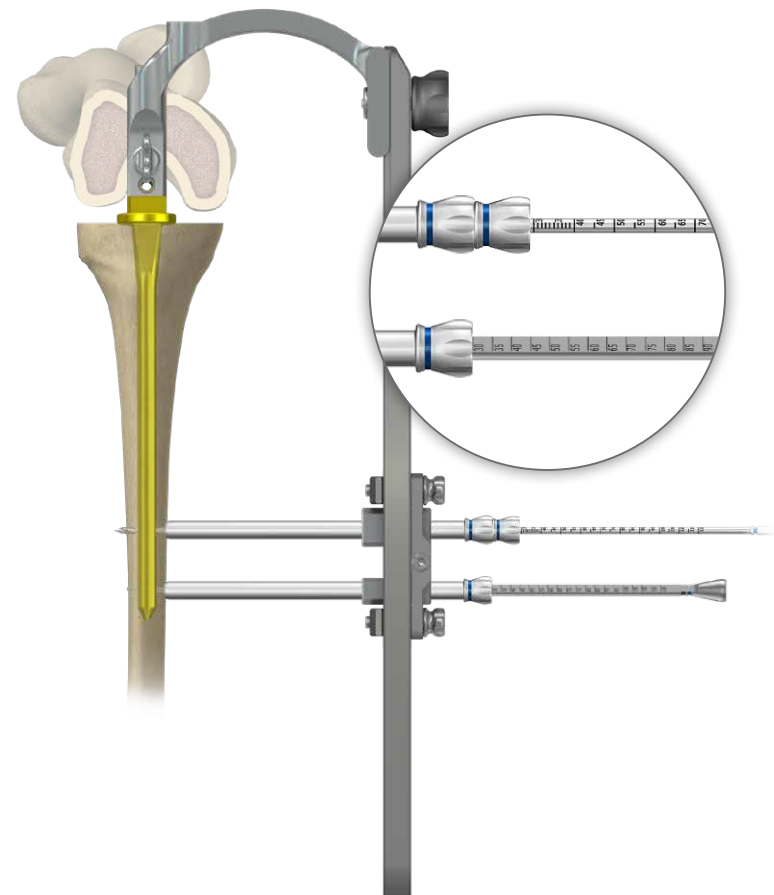
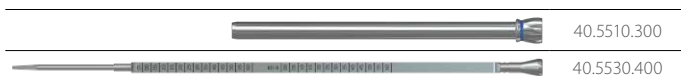

Insert the tip of the screwdriver T25 **[40.5575.300]** into the socket of the determined locking screw and then, through the protective guide, into the drilled hole, until the head of the screw reaches the bone (*the mark on the screwdriver shaft shall match the edge of protective guide*).

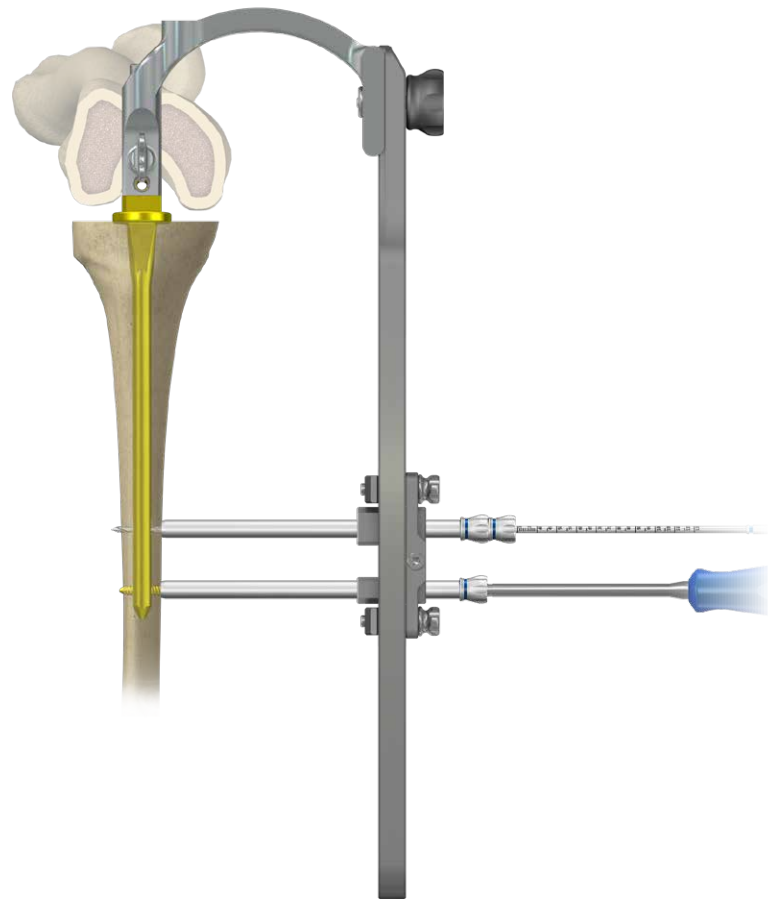
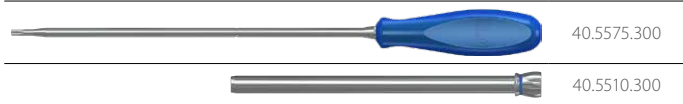

Remove drill with scale 3.5/350 **[40.5339.002]** and drill guide 7/3.5 **[40.5511.300]** from the other hole of distal tibial targeter **[40.6635]** slider. Leave protective guide 9/7 **[40.5510.300]** in the slider. Insert screw length measure **[40.5530.400]**, through the protective guide, into the drilled hole, until the hook of the measure reaches the "exit" plane of the hole.

Read the length of the locking screw on the scale. During measurement, the protective guide should be pressed against the bone.

Remove the screw length measure.
Leave the protective guide in place.

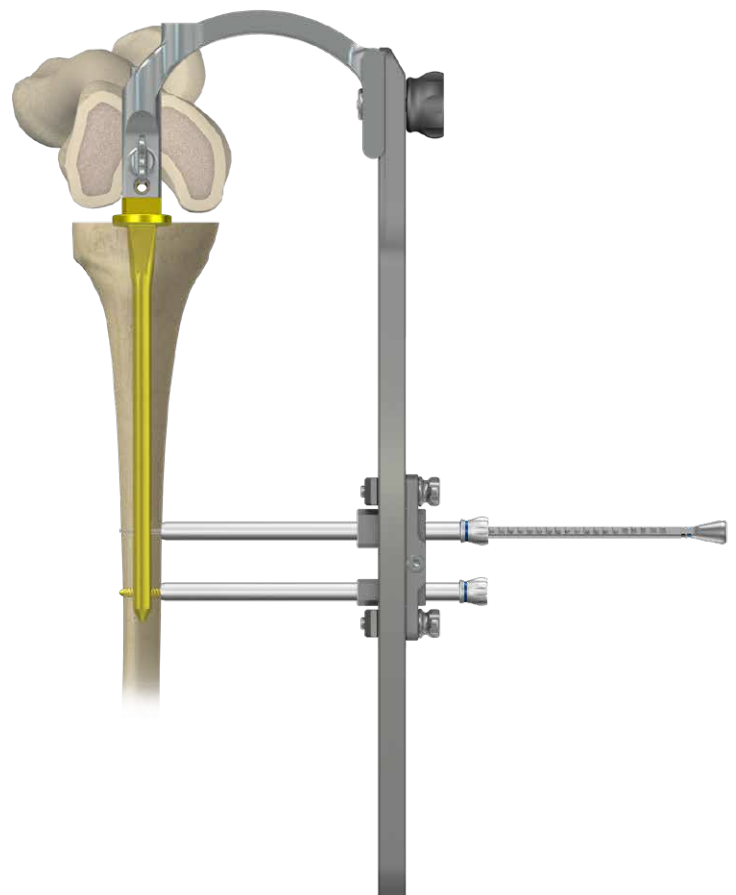
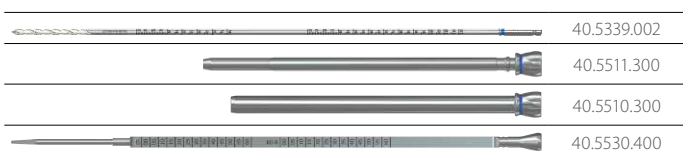

Insert the tip of the screwdriver T25 **[40.5575.300]** into the socket of the determined locking screw and then, through the protective guide, into the drilled hole, until the head of the screw reaches the bone (*the mark on the screwdriver shaft shall match the edge of protective guide*).

Remove the screwdriver and protective guides.
Remove distal tibial targeter **[40.6635]**.

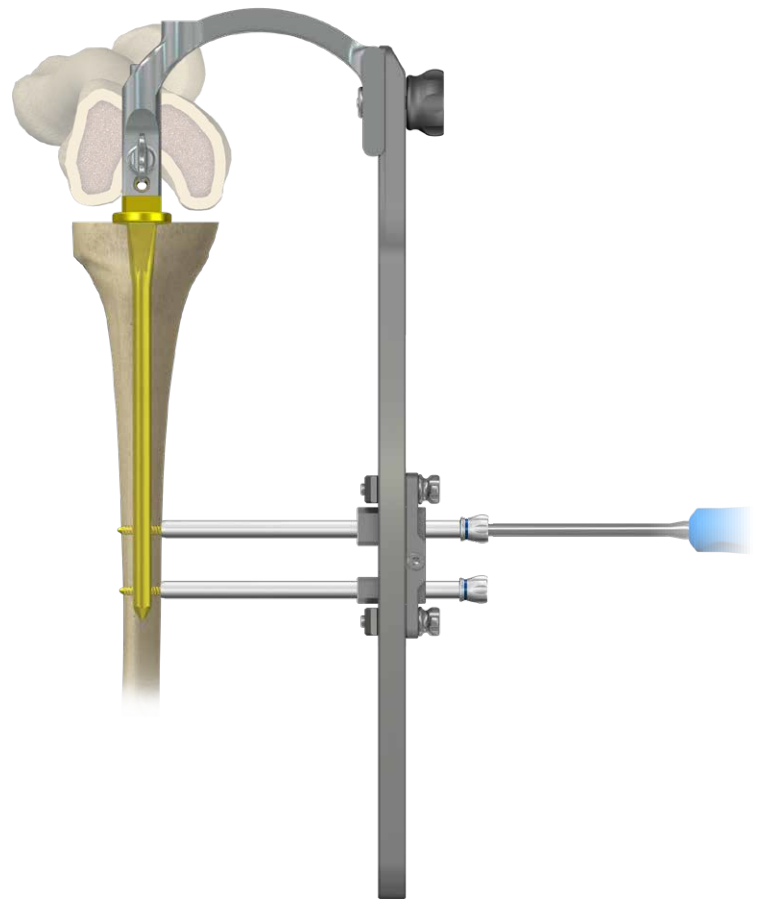
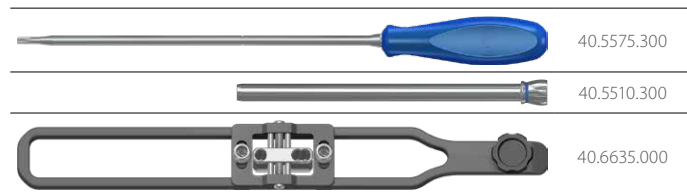

IV.A.3.4. NAIL LOCKING USING "FREE-HAND TECHNIQUE"



The radiological control is necessary to determine the drilling location of the holes and drilling procedure itself.

It is recommended to use an angular drill attachment for drilling holes, so that the operator's hands are outside the direct X-Ray exposure. Mark on the skin the points for drill insertion and perform incisions of soft tissues passing through these points of about 1.5 cm. Use the X-Ray device to position the protective guide short [40.5871.100] in relation to the hole in the nail.



The holes in the nail and the protective guide short [40.5871.100] must overlap.

Insert trocar short 7 [40.1354.200] into the protective guide short and mark the entry point for the drill.

Remove the trocar short.

The sharp end of the protective guide short should be immersed in the bone.



40.5871.100

40.1354.200

Insert drill guide short [40.5872.100] into the protective guide short [40.5871.100]. Drill, using drill with the scale 3.5/150 [40.5343.002], a hole that passes through the nail and both cortical layers of the bone. The scale on the drill indicates the length of the locking element.

Remove the drill and drill guide.



The hole drilling should be performed under X-Ray control.



40.5871.100

40.5872.100

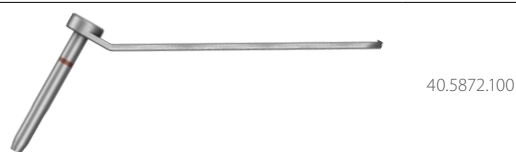

40.5343.002



Insert, through the protective guide short **[40.5871.100]** and into the drilled hole, the screw length measure **[40.5530.400]**, until the tip of the measure leans against the outer surface of the second cortical layer. Read the length of the locking screw on the scale.

Remove the screw length measure.
Leave the protective guide in place.

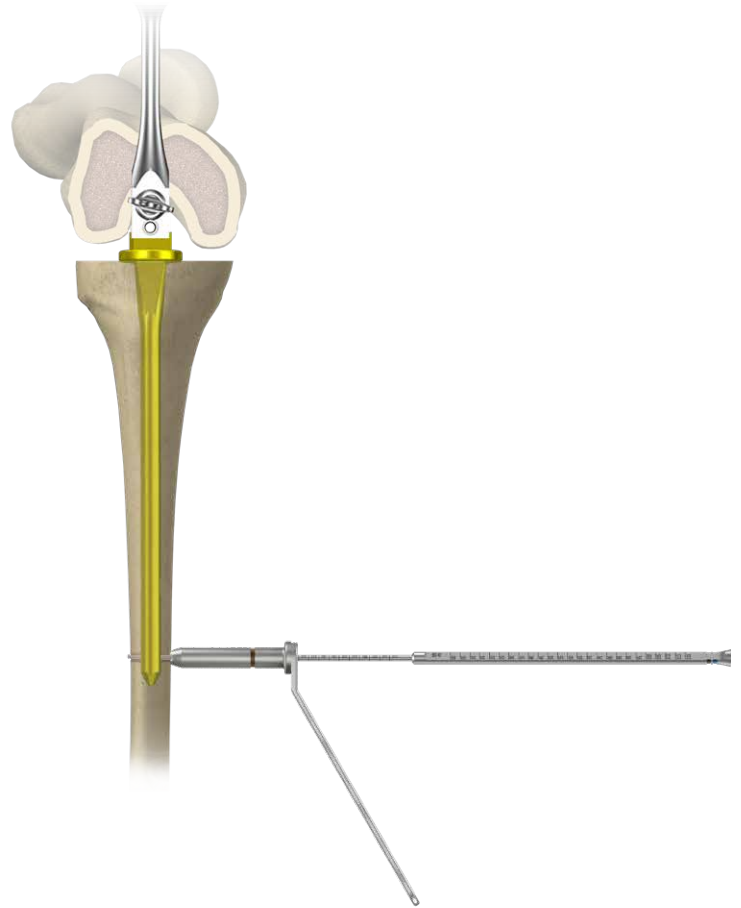
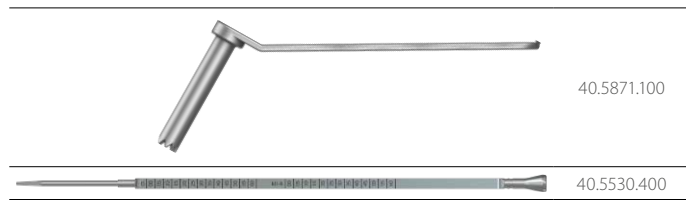

Insert the tip of the screwdriver T25 **[40.5575.300]** into the socket of the determined locking screw and then, through the protective guide short, into the drilled hole, until the head of the screw reaches the bone.

Remove the screwdriver and protective guide.



When locking the other hole, follow the steps of point IV.A.3.4.



Verify, using X-Ray machine, the performed locking in at least two projections.

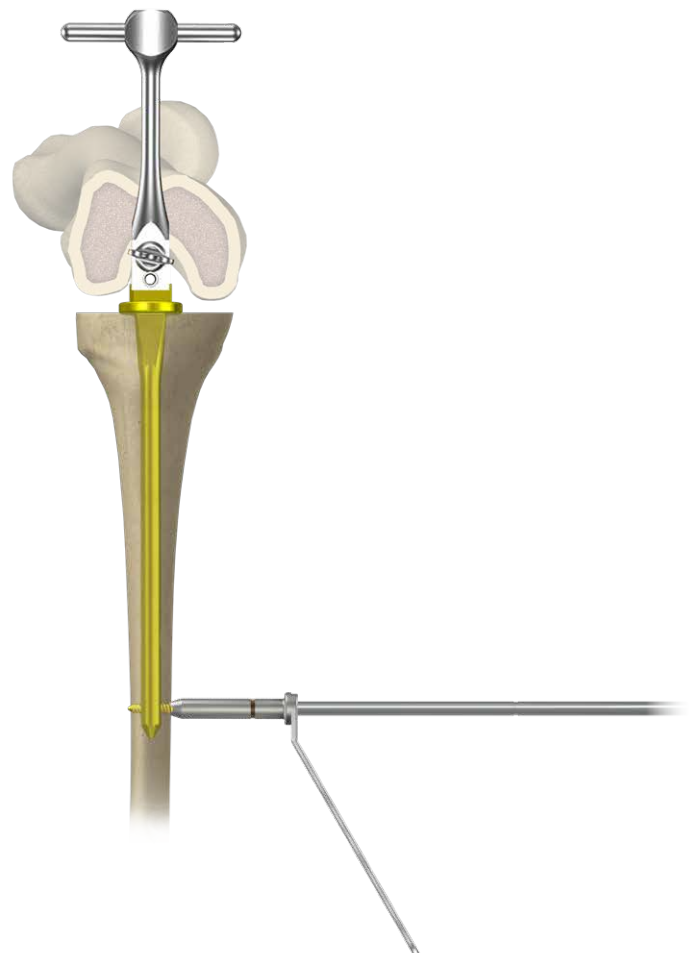
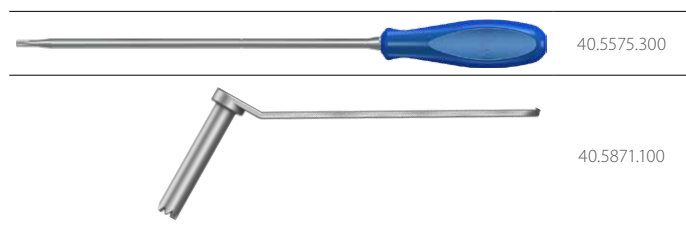

IV.A.4. INSERTION OF CHARFIX2 FN NAIL - FEMUR

IV.A.4.1. Opening of the medullary canal of the femur

Use the curved awl 8.0 [40.5523.100] to open the medullary canal.

Attach the guide rod 3.0/580 [40.3925.580] to the guide rod handle [40.1351.100] and using the curved awl, insert into the medullary canal.

Remove the handle and curved awl.

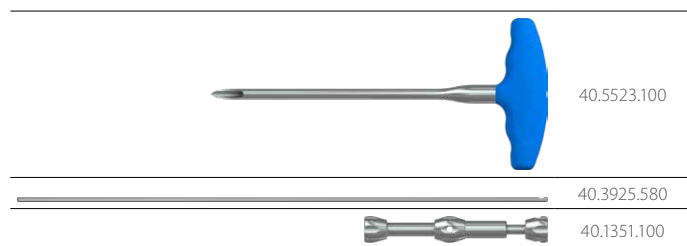

Attach cannulated drill 12/3.0 [40.5314] to a drive and using the protective guide [40.5315.100], deepen the entry point in the medullary canal.

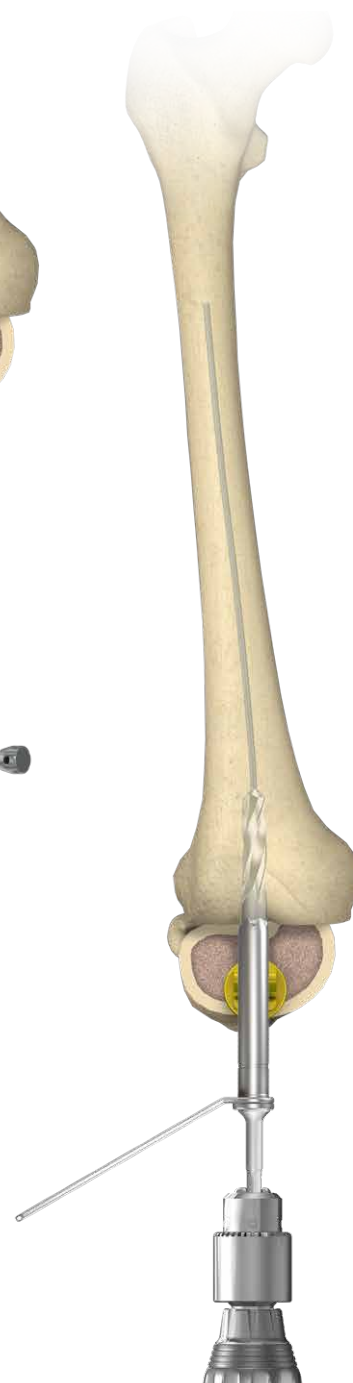
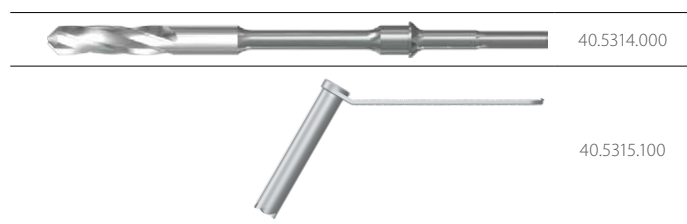

Afterwards, attach a flexible reamer to the drive. Widen the femoral medullary canal gradually until the canal diameter is $1.0 \div 1.5\text{mm}$ larger than the diameter of the selected nail.

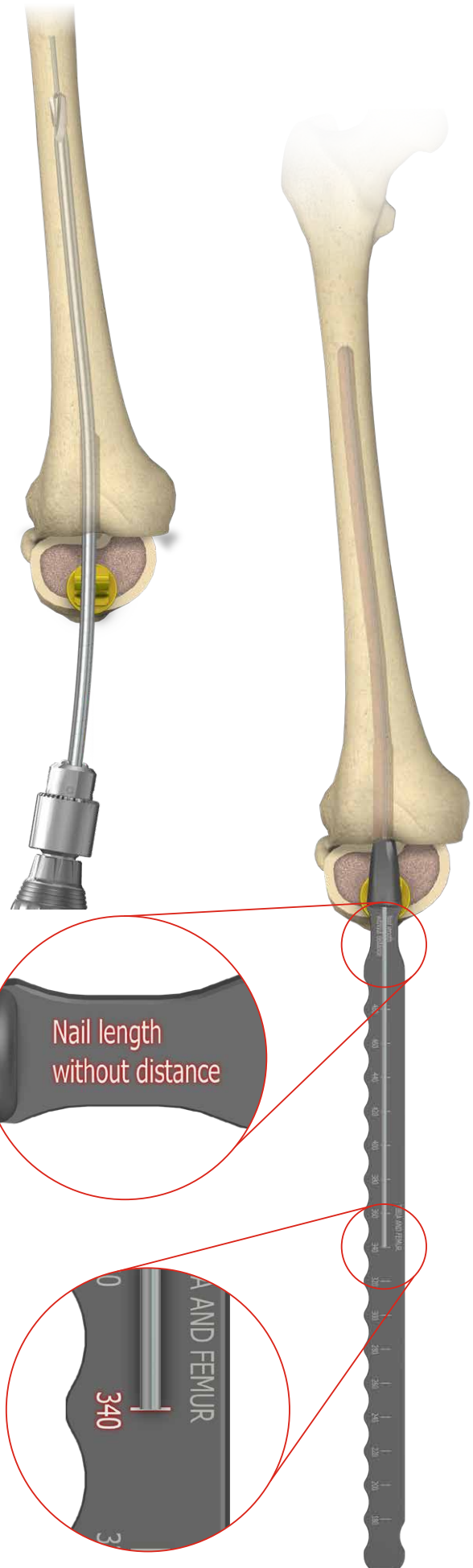

Use the guide rod 3.0/580 **[40.3925.580]** to introduce the nail length measure **[40.6641.000]**.

Use the scale on the measure described as "Nail length without distance". The beginning of the measure should be placed in the nail entry point on the bone. Read the length of the nail on the scale provided.

Remove the measure and guide rod



Use countersink [40.6631] to deepen the entry point to the medullary canal.

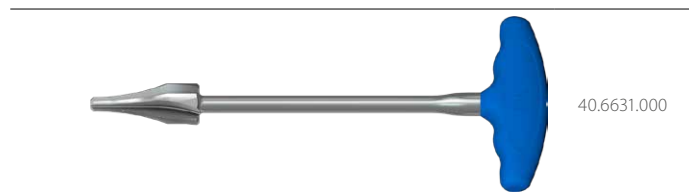

IV.A.4.2. Nail insertion

Attach **CHARFIX2 FN Nail - femur** to the handle [40.6632] and insert into the medullary canal of the femur.

Should significant resistance be felt, attach the impactor-extractor [40.5507.100] and using the mallet [40.3667], insert the implant into the medullary canal.

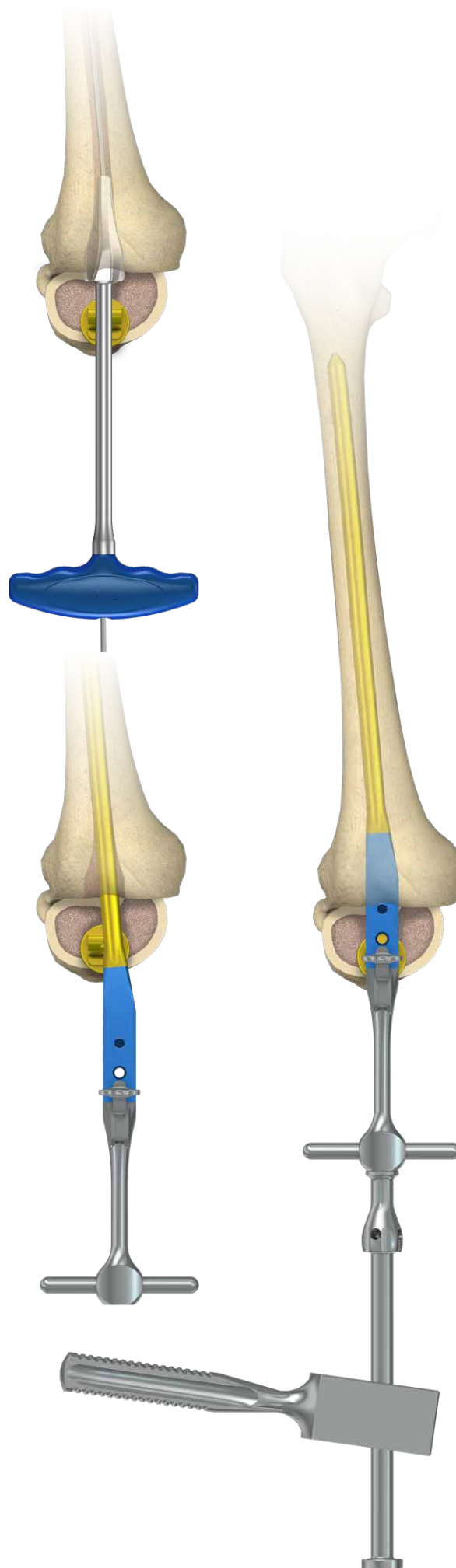
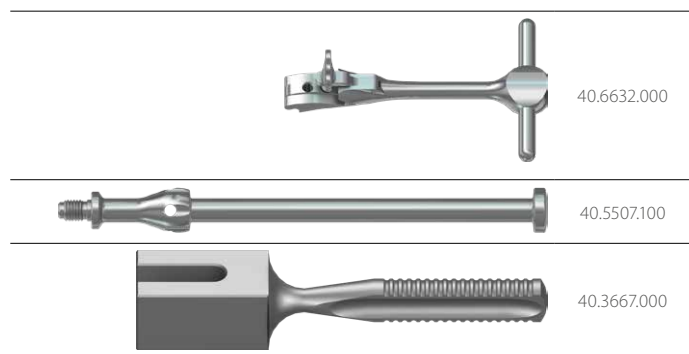

IV.A.5. JOINING CHARFIX2 FN NAIL - FEMUR AND CHARFIX2 FN NAIL - TIBIA

Having inserted both implants, join them the way presented, connecting the tibial with femoral part.

Should there be no access to the holes in the implants, use an oscillating saw to prepare the access (a "window") allowing the screws to be inserted to connect the two implants.

Next, lift the tibial part of the limb until both implants are completely joined.

Use **CHARFIX2 FN Screws T [3.6300]** and screwdriver T25 **[40.5575.300]** to joint the both implants.



After joining the implants, determine the correct length of the operated limb by adjusting the position of the tibial part in relation to the femoral part.



40.5575.300

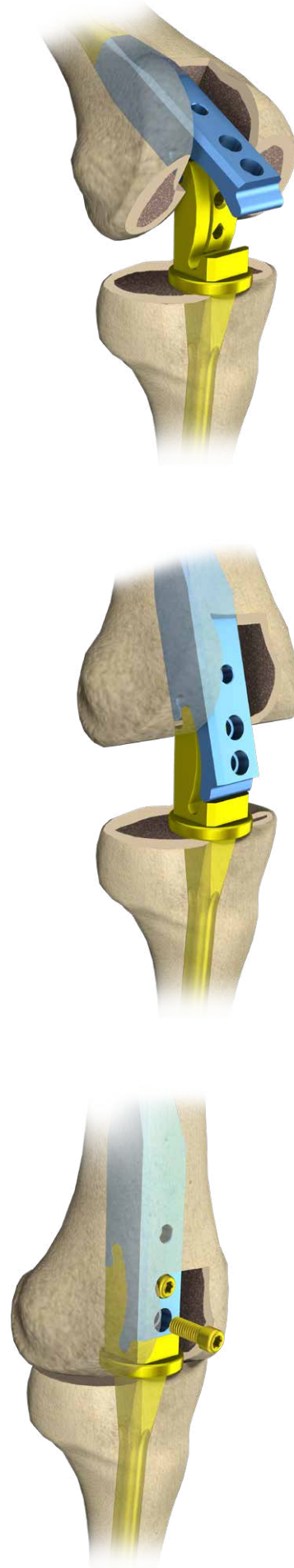

IV.A.6. CHARFIX2 FN NAIL - FEMUR - DISTAL LOCKING



The radiological inspection is necessary to determine the drilling location and procedure.

For holes drilling, it is recommended to use an angular drill adapter, so that the operator's hands are outside the X-Rays radiation.

Mark on the skin an entry point for the drill and perform soft tissues incision for about 1.5 cm.

Use the X-Ray device to position the protective guide short **[40.5871.100]** in relation to the hole in the nail.



The holes in the nail and the protective guide short **[40.5871.100]** must overlap.

The protective guide end must be immersed in the bone.

Insert the short trocar **[40.1354.200]** into the protective guide short and mark on the bone the entry point for the drill.

Remove the short trocar.



40.5871.100



40.1354.200

Insert drill guide short **[40.5872.100]** into the protective guide short **[40.5871.100]**.
Use drill with scale 3.5/150 **[40.5343.002]** to drill a hole through the nail and both cortical layers of the bone.

The scale on the drill indicates the length of the locking element.

Remove the drill and drill guide.

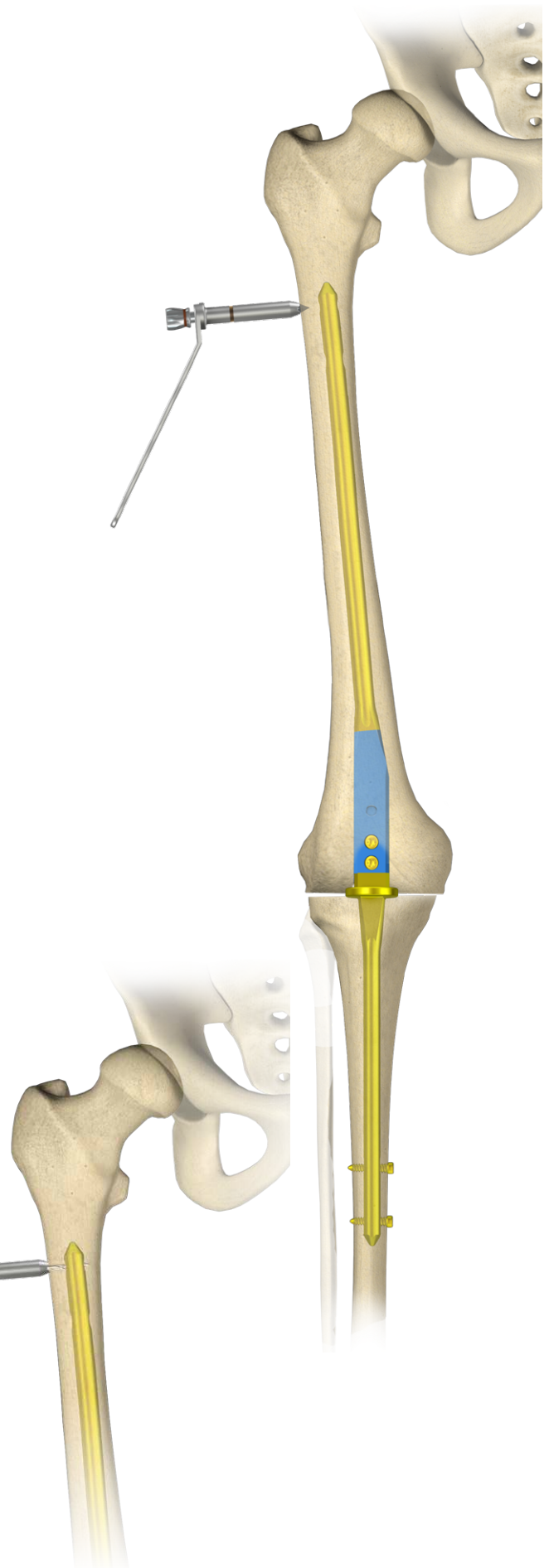

Insert the screw length measure **[40.5530.400]**, through the protective guide short **[40.5871.100]**, into the drilled hole, until the hook of the measure leans against the outer surface of the bone. Use the measure scale to determine the length of the locking screw.

Remove the screw length measure.
Leave the protective guide in the place.

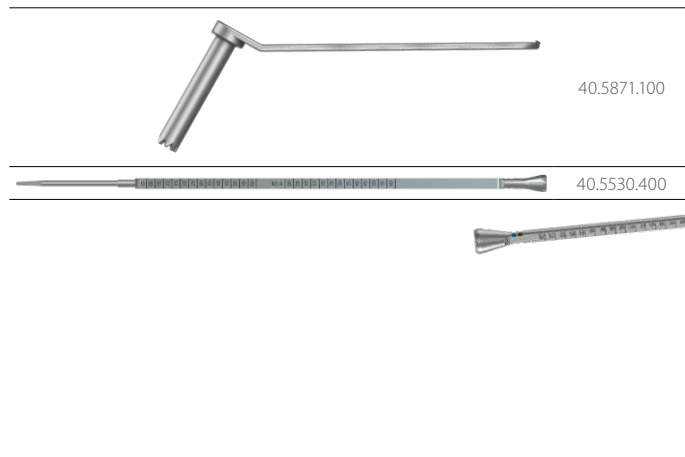

Insert the tip of the screwdriver T25 **[40.5575.300]** into the socket of selected locking screw and then, through protective guide short **[40.5871.100]**, into the hole until the head of the screw reaches the cortex of the bone.
Remove the screwdriver and the protective guide.



When locking the other hole, follow the steps of point IV.A.6.



Verify, using X-Ray machine, the performed locking in at least two projections.

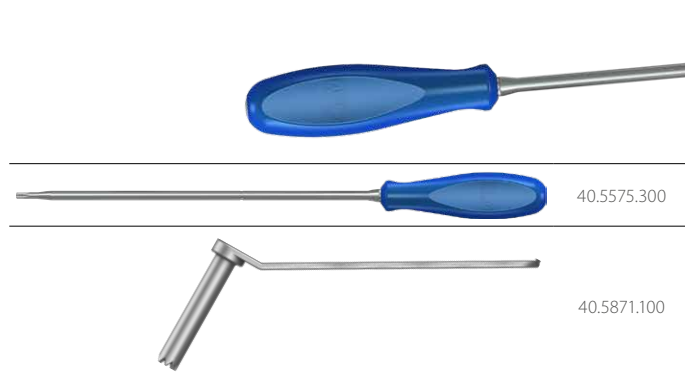

IV.A.7. IMPLANT REMOVAL

Use screwdriver T25 [40.5575.300] to remove the screws that lock the two implants.

Use screwdriver T25 [40.5575.300] to remove the **CHARFIX2 FN** Screws T [3.6300] that join the femoral and tibial nail. Disconnect **CHARFIX2 FN** Nail - femur and **CHARFIX2 FN** Nail - tibia.

Attach the handle [40.6632] to **CHARFIX2 FN** Nail - femur and then impactor-extractor [40.5507.100] to the handle. Use mallet [40.3667] to remove the implant from the bone.

Attach the handle [40.6633] to **CHARFIX2 FN** Nail - tibia and then impactor-extractor [40.5507.100] to the handle. Use mallet [40.3667] to remove the implant from the bone.

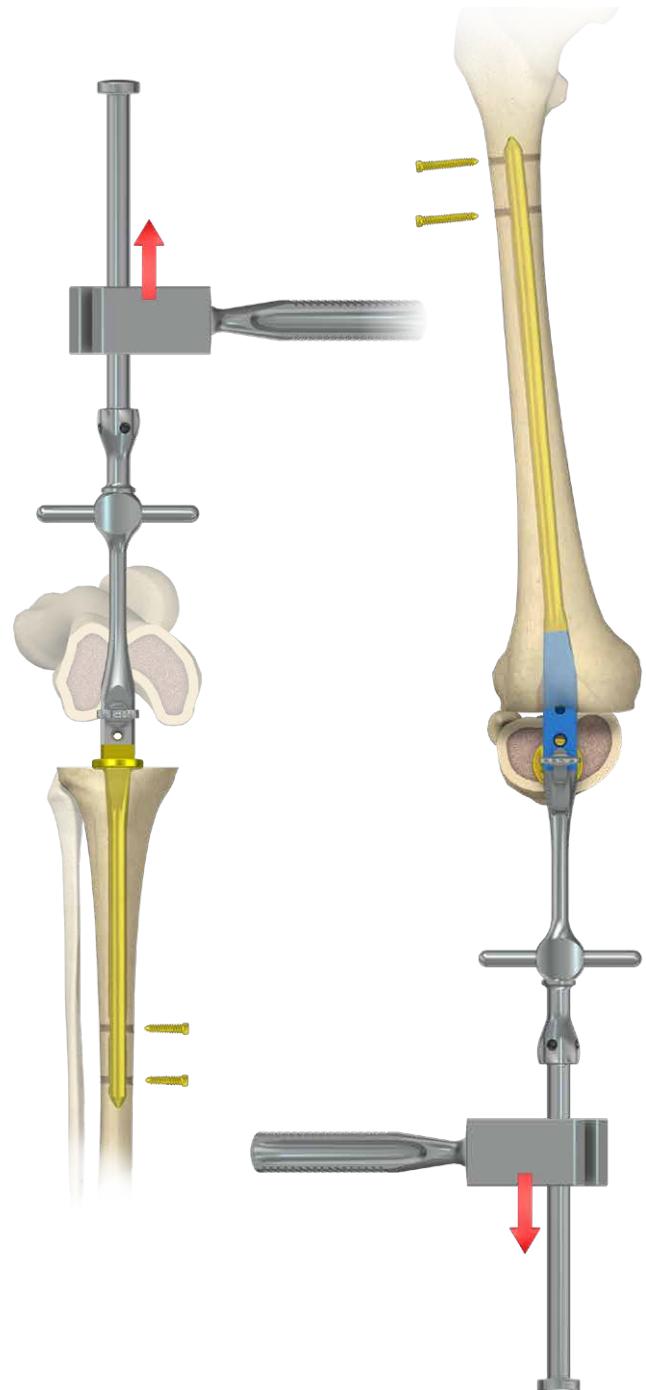
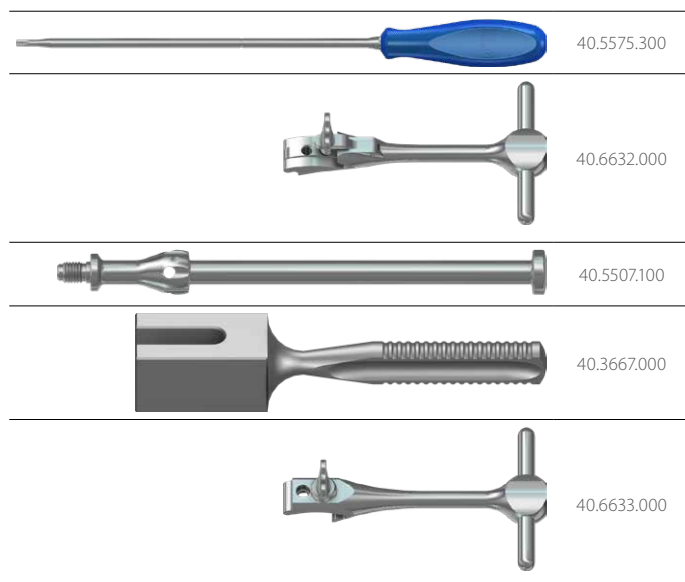

IV.B. WITH KNEE RESECTION

IV.B.1. PATIENT POSITIONING

Place the patient supine with their limb straight.
The surgery must be properly planned.
It is necessary to take X-Ray pictures.

IV.B.2. SURGICAL APPROACH

Make a vertical incision of tissues extending from the region of the femoral condyle to the tibial tuberosity allowing free access to the affected joint.

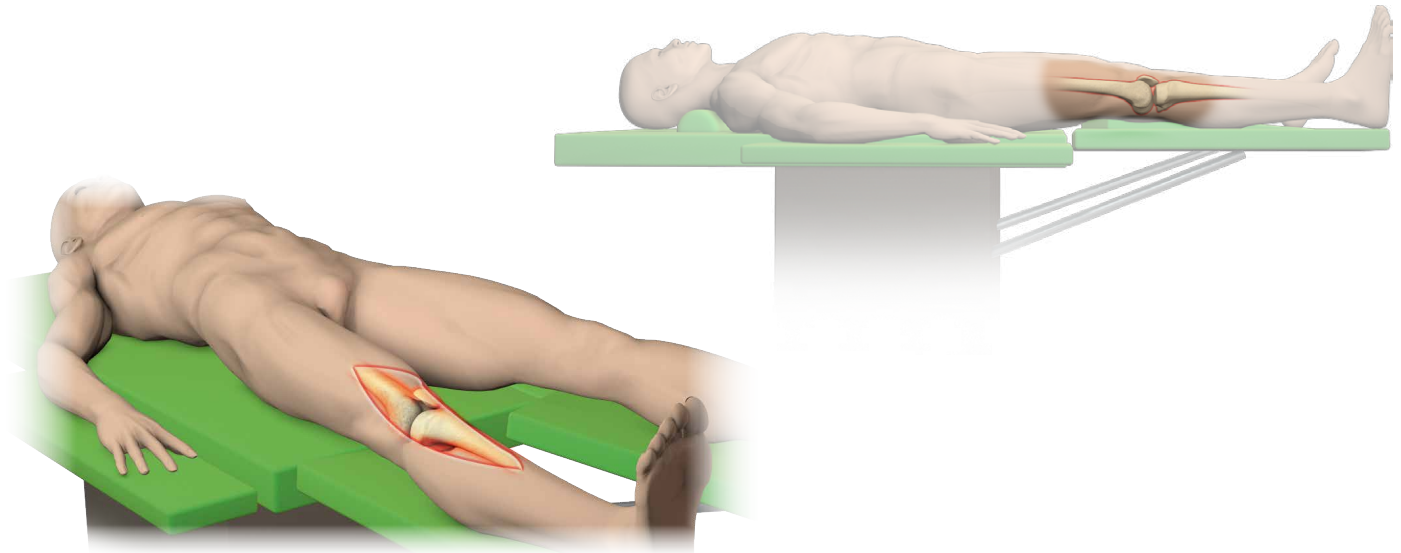

IV.B.3. KNEE RESECTION

The prosthesis, if has been used, must be removed.
Use a bone saw to cut off the diseased ends of the joint on both the femoral and tibial sides. The saw blade should be led perpendicular to the axis of the bone. Do not lean the saw blade.

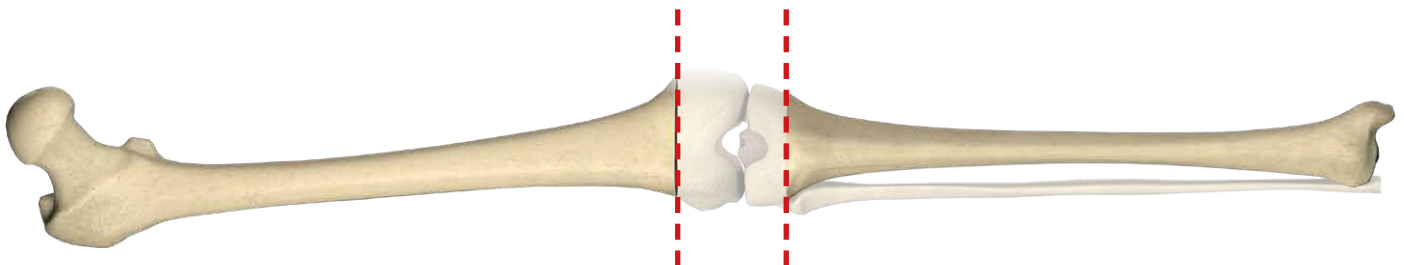

IV.B.4. INSERTION OF CHARFIX2 FN NAIL - TIBIA

IV.B.4.1. Opening of the medullary canal of the tibia

Use the curved awl 8.0 [40.5523.100] to open the medullary canal.

Attach the guide rod 3.0/580 [40.3925.580] to the guide rod handle [40.1351.100] and using the curved awl, insert into the medullary canal.

Remove the handle and curved awl.

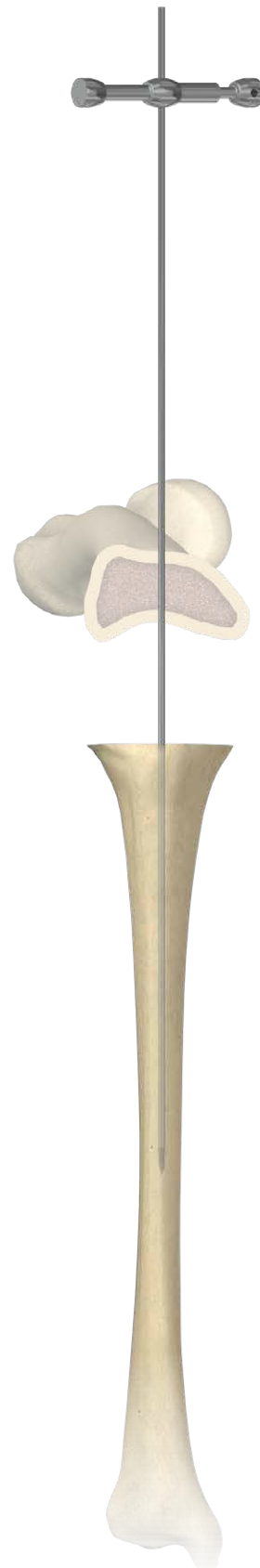
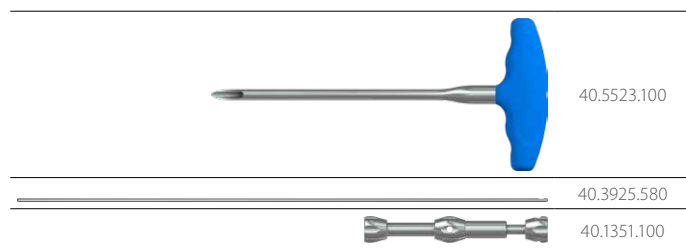

Attach cannulated drill 12/3.0 [40.5314] to a drive and using the protective guide [40.5315.100], deepen the entry point in the medullary canal.

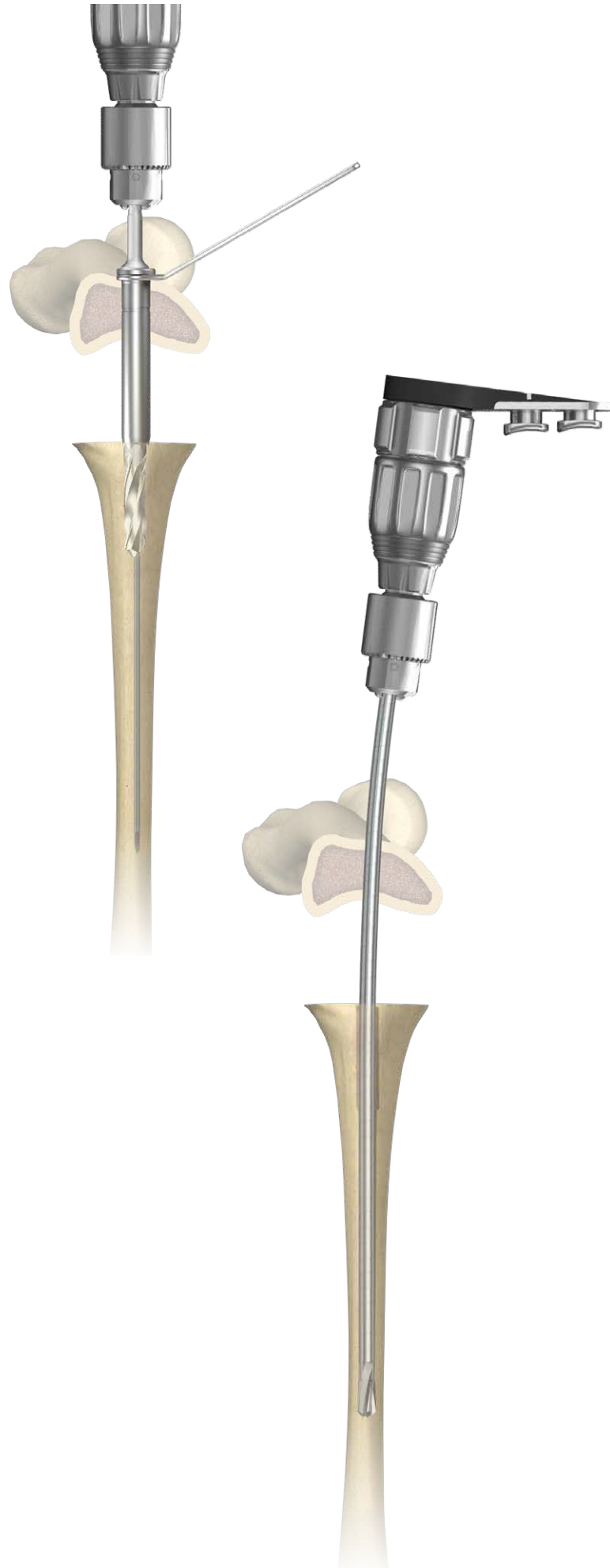
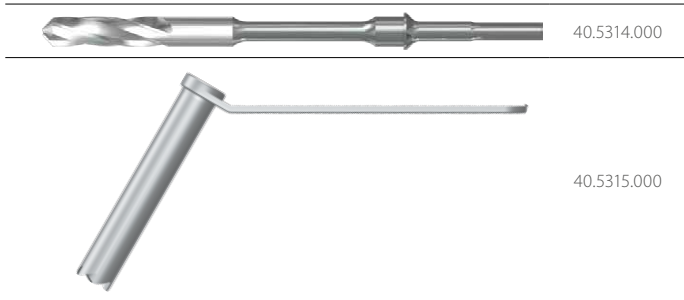

Afterwards, attach a flexible reamer to the drive. Widen the tibial medullary canal gradually until the canal diameter is 1.0 ÷ 1.5mm larger than the diameter of the selected nail.

Use the guide rod 3.0/580 [40.3925.580] to introduce the nail length measure [40.6641].

Use the scale on the measure described as "Nail length with distance" on the "TIBIA" side. The beginning of the measure should be placed in the nail entry point on the bone. Read the length of the nail on the scale provided.

Remove the measure and guide rod

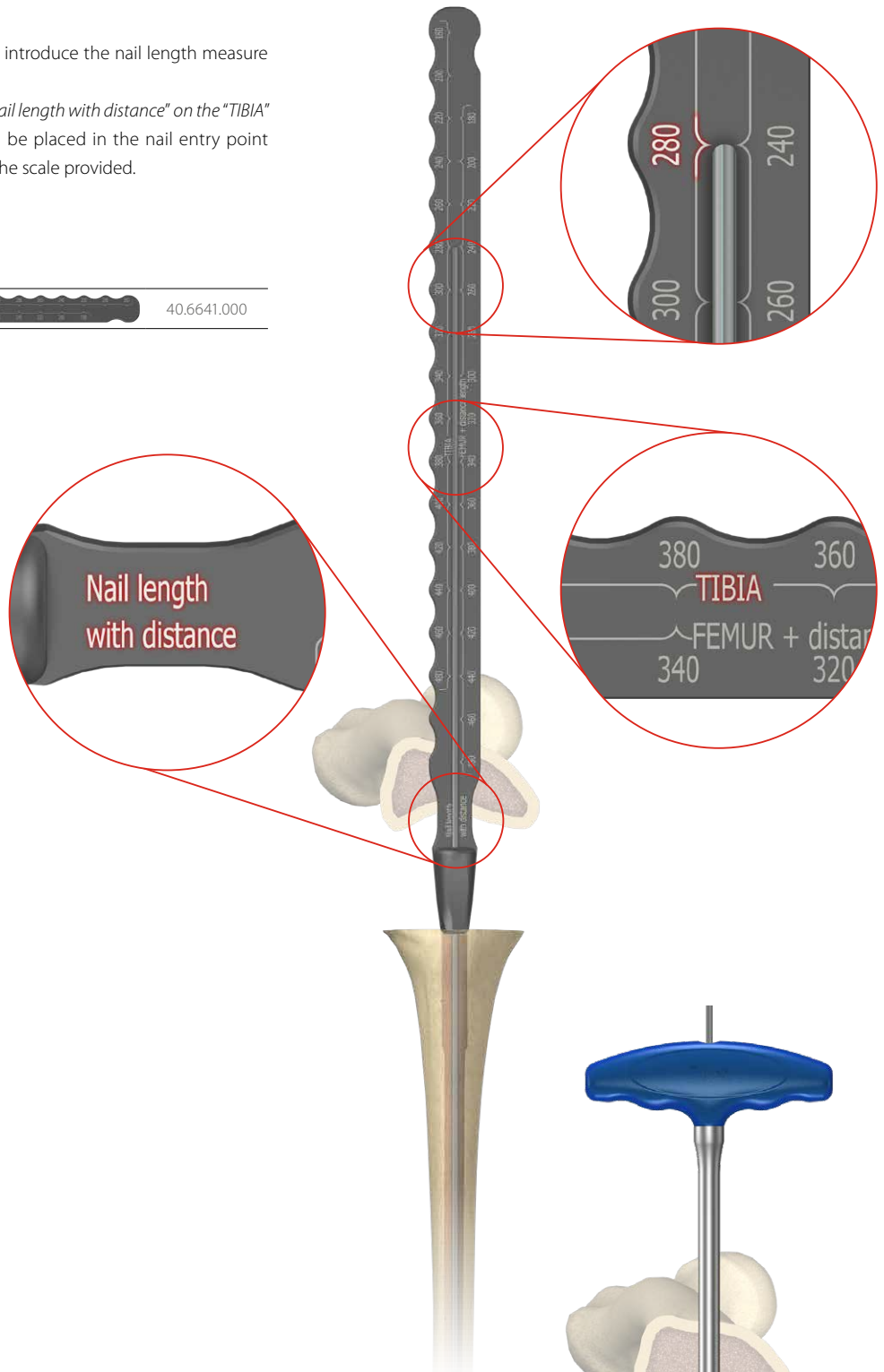

Use countersink [40.6631] to deepen the entry point to the medullary canal.

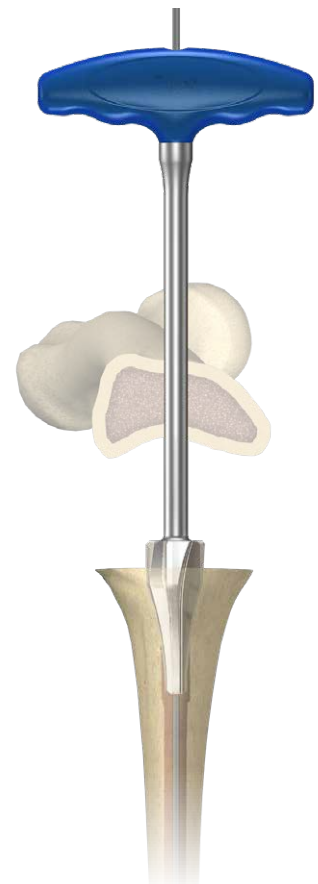
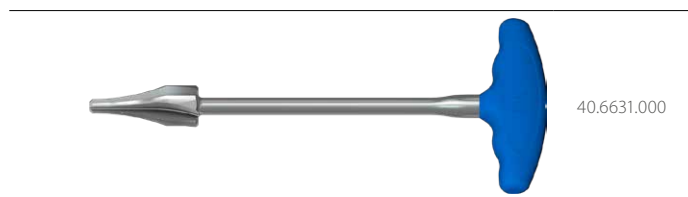

IV.B.4.2. Targeters assembly

The targeter arm [40.6634] can be used with both right and left limb. Use wrench S8 [40.5304.100] to loosen the connecting screw of the targeter arm and rotate the targeter arm connector by 180°.

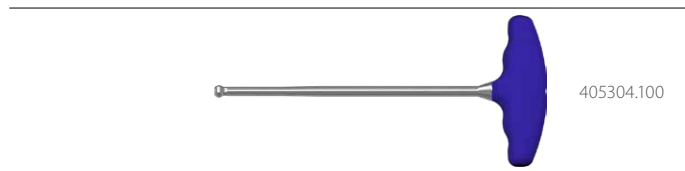

IV.B.4.3. Nail insertion

Prior to nail insertion, determine the position of the distal tibial targeter [40.6635] in relation to the nail holes. For this purpose, attach CHARFIX2 FN Nail - tibia to the targeter arm [40.6634]. Afterwards, attach the distal tibial targeter to the targeter arm. Using screwdriver T25 [40.5575.300], loosen the locking screws of a slider (allowing the slider to move) and move it near the holes in the distal part of the nail.

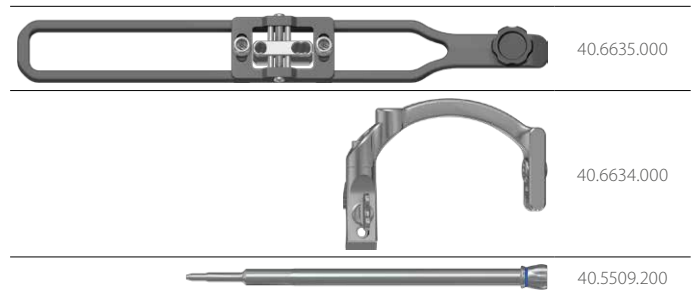

Determine the correct position of the targeter slider in relation to the nail holes in the distal part using two set blocks 9/5,0 [40.5509.200]. Lock the targeter slider with the screws using screwdriver T25.

Remove set blocks.



VERIFY: if the targeter slider is properly set and locked, the set blocks should pass through nail holes.

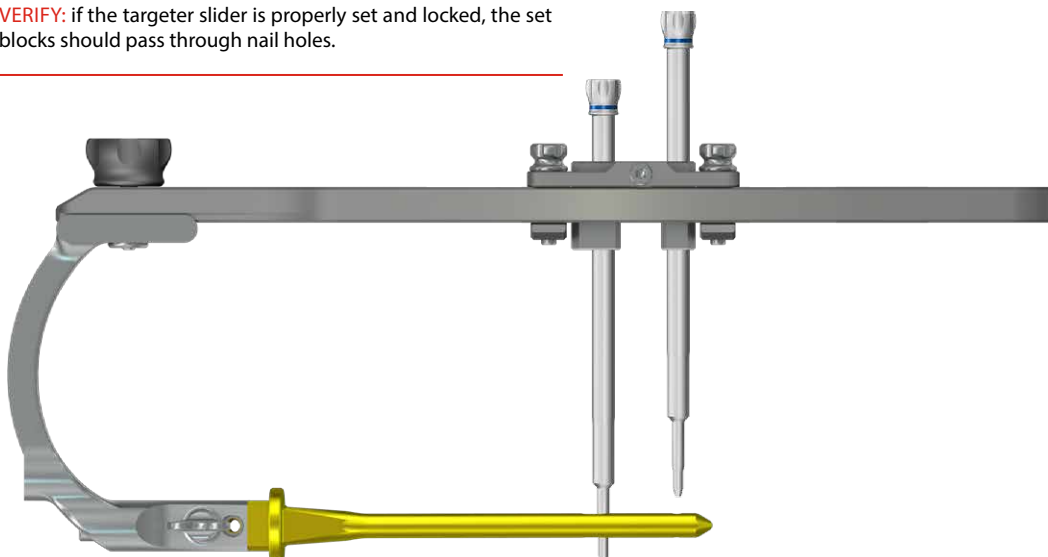

Remove distal tibial targeter [40.6635] from the targeter arm [40.6634]. Attach impactor-extractor [40.5507.100] to the targeter arm. Use the mallet [40.3667] to insert the nail into the tibia medullary canal.

Remove impactor-extractor.

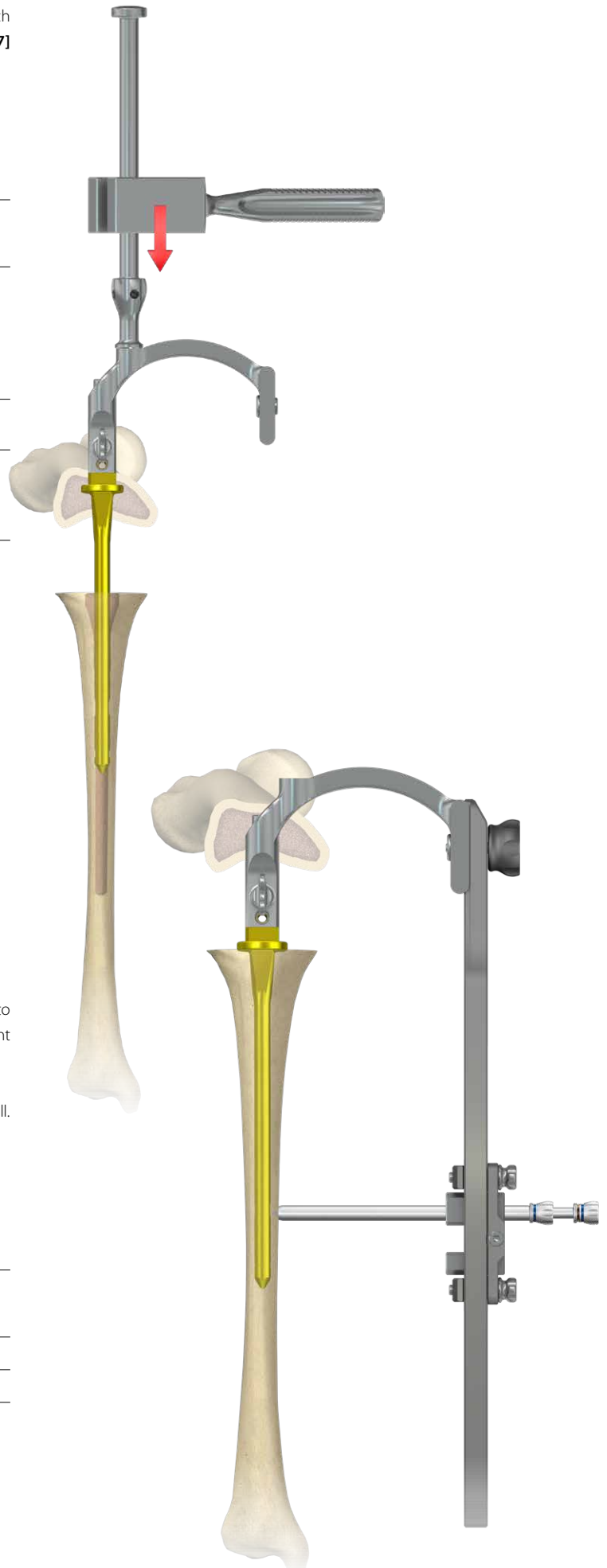
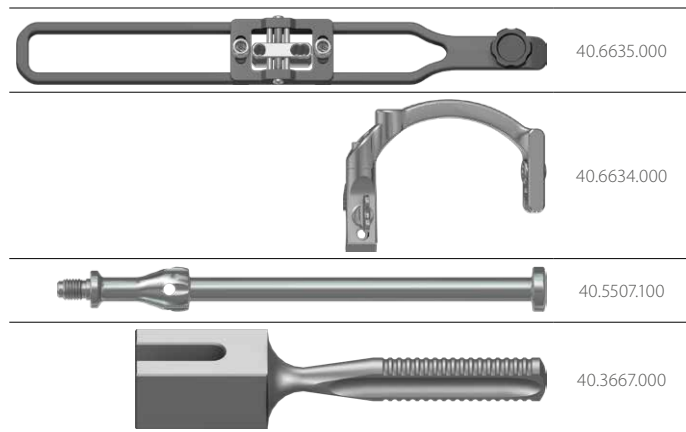

Attach the distal tibial targeter [40.6635] to the targeter arm [40.6634].

Insert the protective guide 9/7 [40.5510.300] and trocar 6.5 [40.5534.200] into the proximal hole of the distal tibial targeter [40.6635] slider. Mark the entry point for a locking screw on the skin and make an incision of soft tissues.

Push the protective guide and trocar to the bone and mark the entry point for a drill.

Remove the trocar.

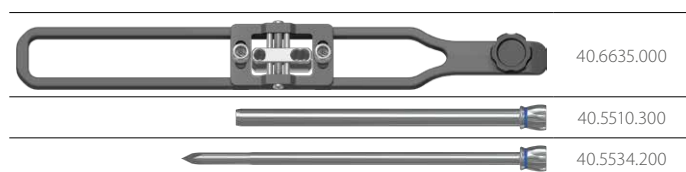

Insert the drill guide 7/3.5 **[40.5511.300]** into the protective guide. Use a drive and the drill with scale 3.5/350 **[40.5339.002]**, guided in the drill guide, to drill a hole in the tibia through both cortical layers and the hole in the nail. The scale on the drill indicates the length of the locking element.

Remove the drive, leave the drill with guides in place.

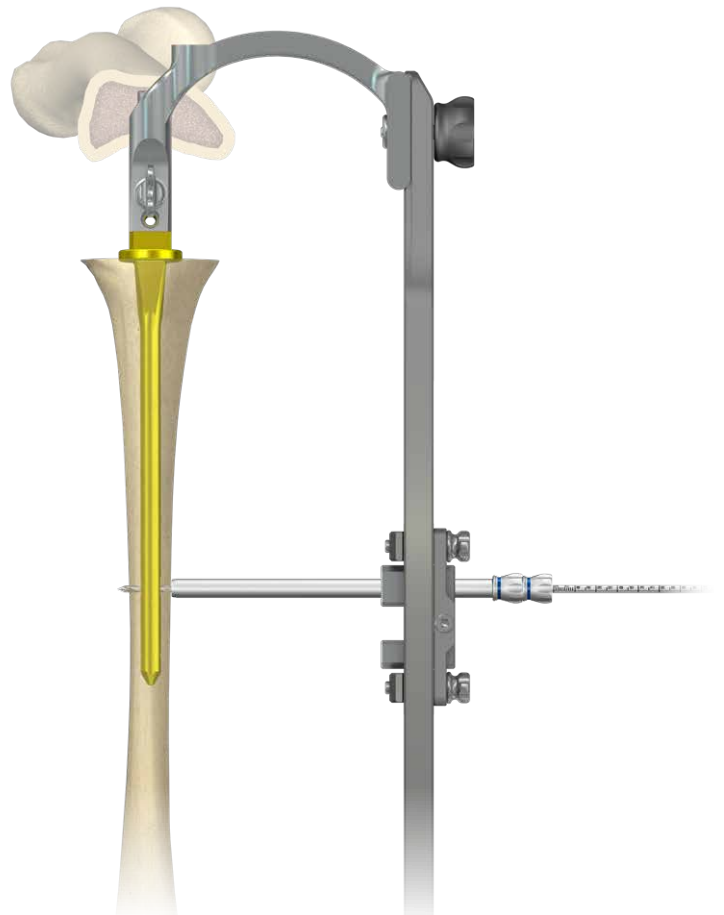

Insert the protective guide 9/7 **[40.5510.300]** and trocar 6.5 **[40.5534.200]** into the other hole of the distal tibial targeter **[40.6635]** slider. Mark the entry point for the locking screw on the skin and make the incision of soft tissues.

Push the protective guide and trocar to the bone and mark the entry point for the drill.

Remove the trocar.

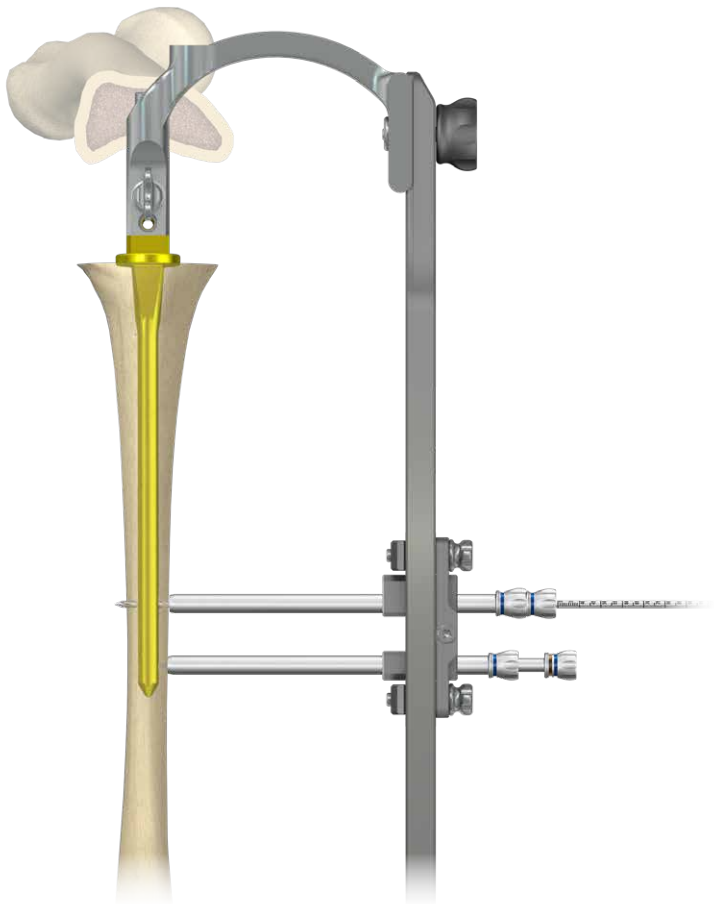
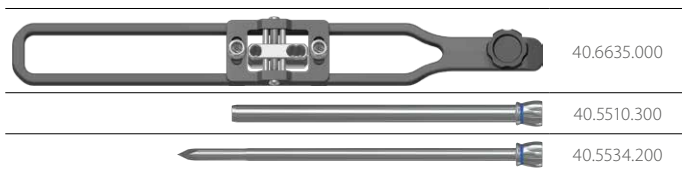

Insert the drill guide 7/3.5 [40.5511.300] into the protective guide. Use the drive and the drill with scale 3.5/350 [40.5339.002], guided in the drill guide, to drill a hole in the tibia through both cortical layers and the hole in the nail. The scale on the drill indicates the length of the locking element.

Remove the drill and the drill guide.

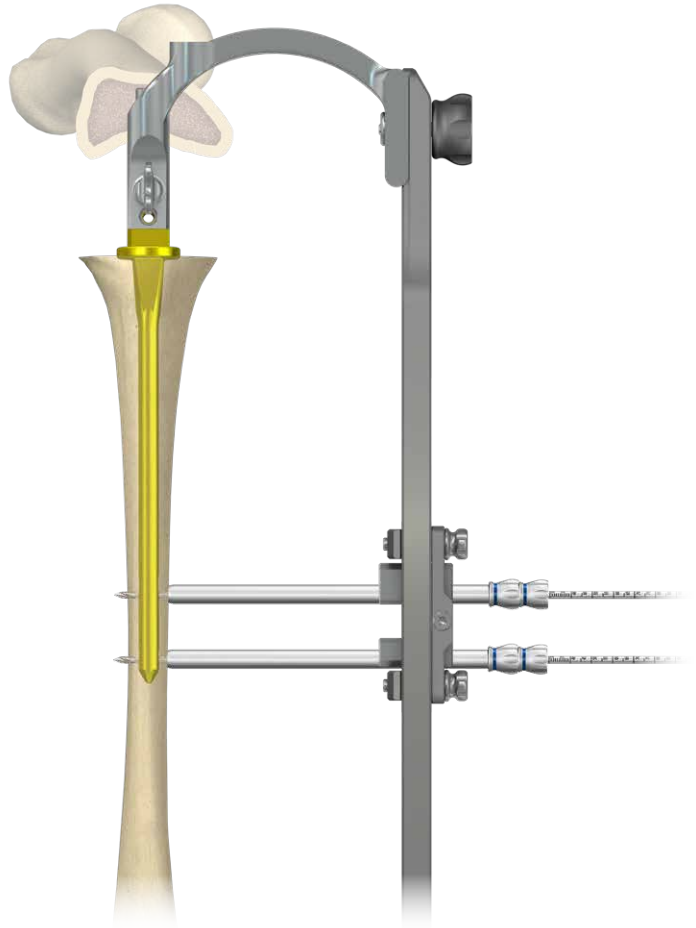

Using the protective guide 9/7 [40.5510.300], insert the screw length measure [40.5530.400] into the drilled hole until its hook reaches the "exit" plane of the hole. Read the length of the locking screw on the scale. During measurement, the protective guide should be pressed against the bone.

Remove the screw length measure.

Leave the protective guide in place.

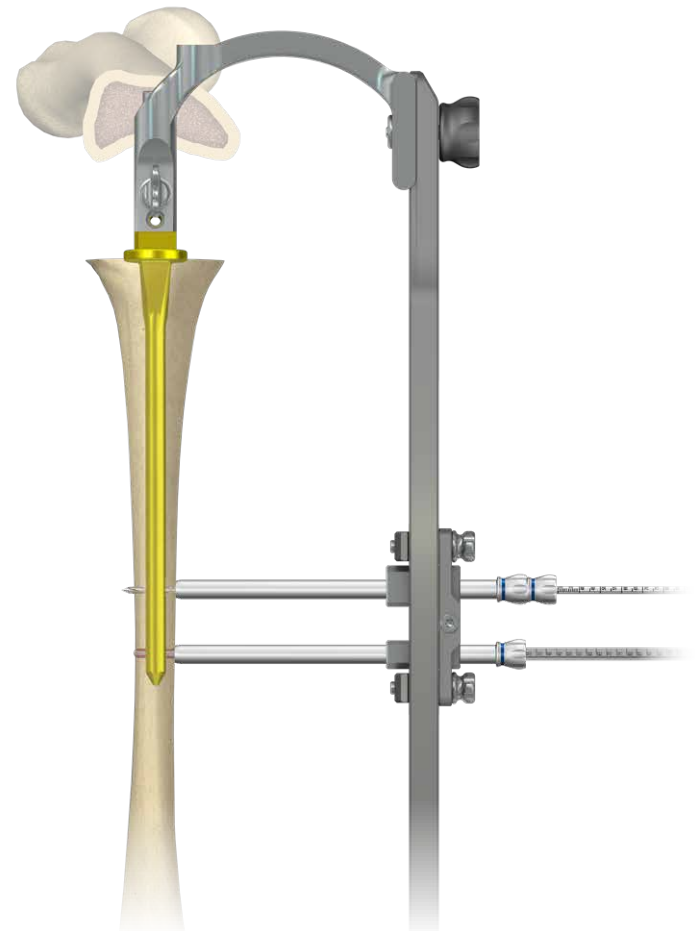
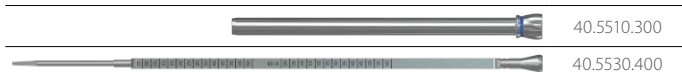

Insert the tip of the screwdriver T25 [40.5575.300] into the socket of the determined locking screw and then, through the protective guide, into the drilled hole, until the head of the screw reaches the bone (*the mark on the screwdriver shaft shall match the edge of protective guide*).

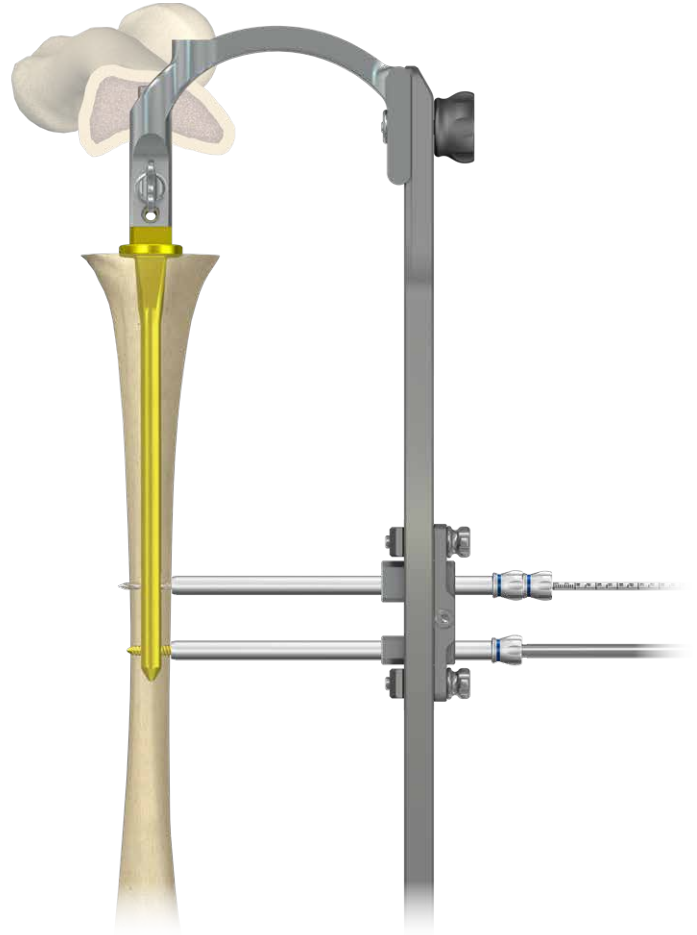
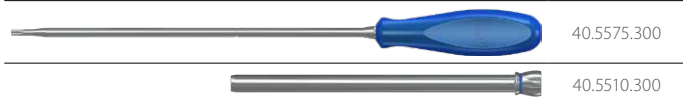

Remove drill with scale 3.5/350 [40.5339.002] and drill guide 7/3.5 [40.5511.300] from the proximal hole of distal tibial targeter [40.6635] slider. Leave protective guide 9/7 [40.5510.300] in the slider. Insert screw length measure [40.5530.400], through the protective guide, into the drilled hole, until the hook of the measure reaches the "exit" plane of the hole.

Read the length of the locking screw on the scale. During measurement, the protective guide should be pressed against the bone.

Remove the screw length measure.

Leave the protective guide in place.

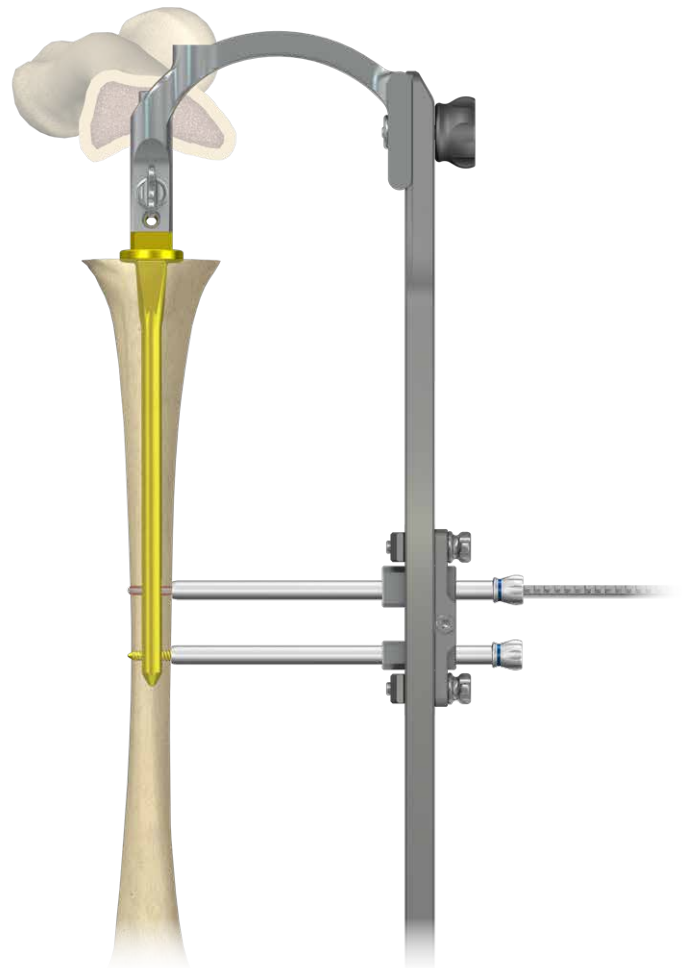
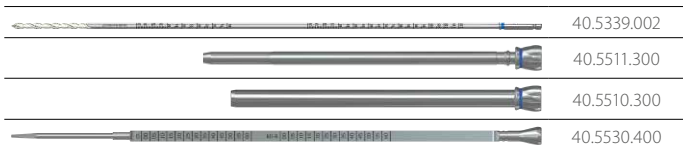

Insert the tip of the screwdriver T25 **[40.5575.300]** into the socket of the determined locking screw and then, through the protective guide, into the drilled hole, until the head of the screw reaches the bone (*the mark on the screwdriver shaft shall match the edge of protective guide*).

Remove the screwdriver and protective guides.

Remove distal tibial targeter **[40.6635]**.

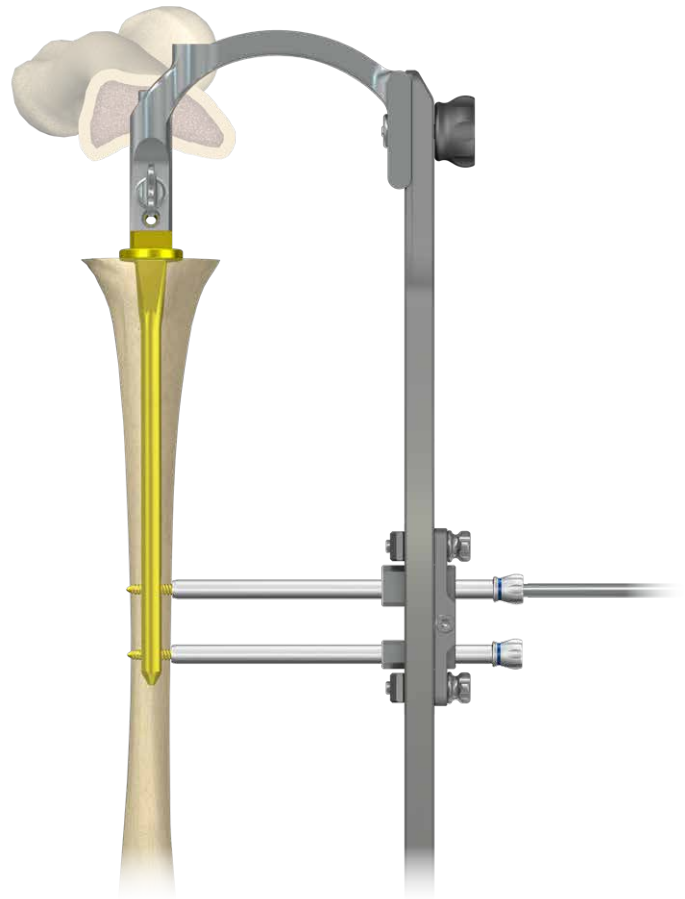
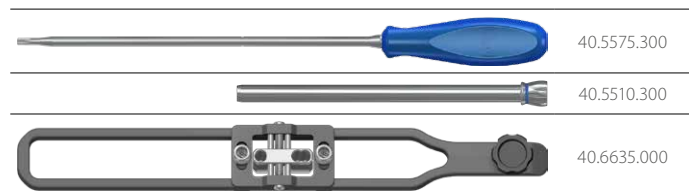

IV.B.4.4. NAIL LOCKING USING "FREE-HAND TECHNIQUE"



The radiological control is necessary to determine the drilling location of the holes and drilling procedure itself.

It is recommended to use an angular drill attachment for drilling holes, so that the operator's hands are outside the direct X-Ray exposure. Mark on the skin the points for drill insertion and perform incisions of soft tissues passing through these points of about 1.5 cm. Use the X-Ray device to position the protective guide short [40.5871.100] in relation to the hole in the nail.



The holes in the nail and the protective guide short [40.5871.100] must overlap.

The sharp end of the protective guide short should be immersed in the bone. Insert trocar short 7 [40.1354.200] into the protective guide short and mark the entry point for the drill.

Remove the trocar short.



40.5871.100



40.1354.200

Insert drill guide short [40.5872.100] into the protective guide short [40.5871.100]. Drill, using drill with the scale 3.5/150 [40.5343.002], a hole that passes through the nail and both cortical layers of the bone. The scale on the drill indicates the length of the locking element.

Remove the drill and drill guide.



The hole drilling should be performed under X-Ray control.



40.5871.100

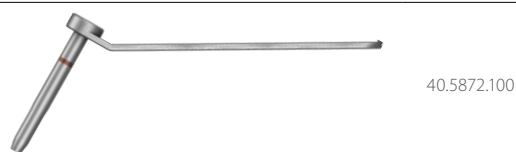

40.5872.100

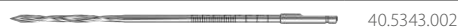

40.5343.002

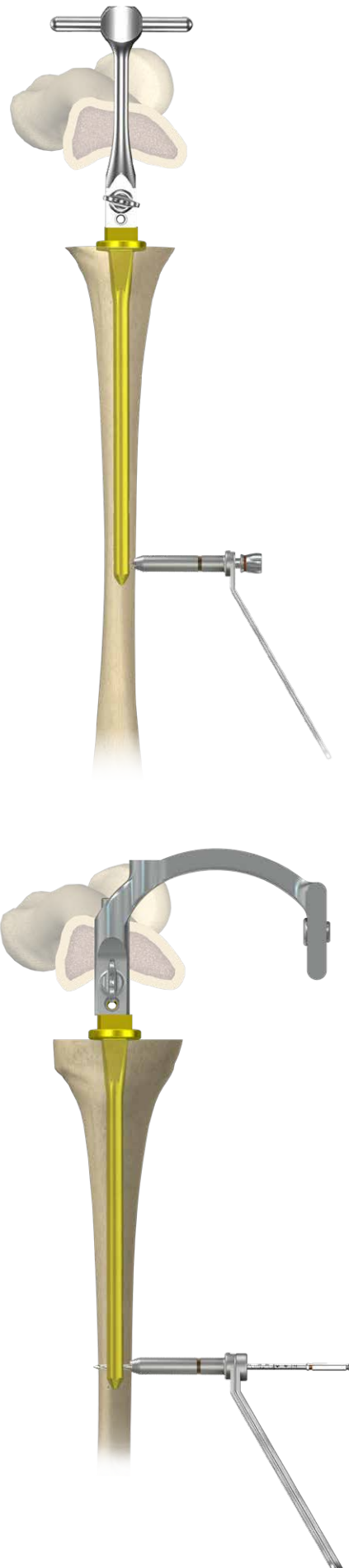

Insert, through the protective guide short [40.5871.100] and into the drilled hole, the screw length measure [40.5530.400], until the hook of the measure reaches the "exit" plane of the hole. Read the length of the locking screw on the scale.

Remove the screw length measure.
Leave the protective guide in place.

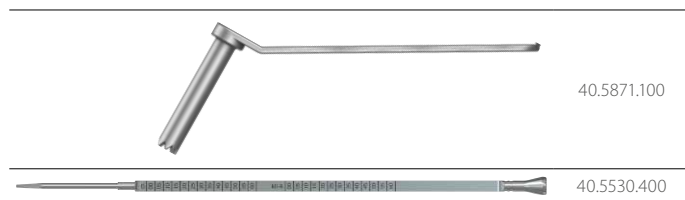

Insert the tip of the screwdriver T25 [40.5575.300] into the socket of the determined locking screw and then, through the protective guide short, into the drilled hole, until the head of the screw reaches the bone.

Remove the screwdriver and protective guide.



When locking the other hole, follow the steps of point IV.B.4.4.



Verify, using X-Ray machine, the performed locking in at least two projections.

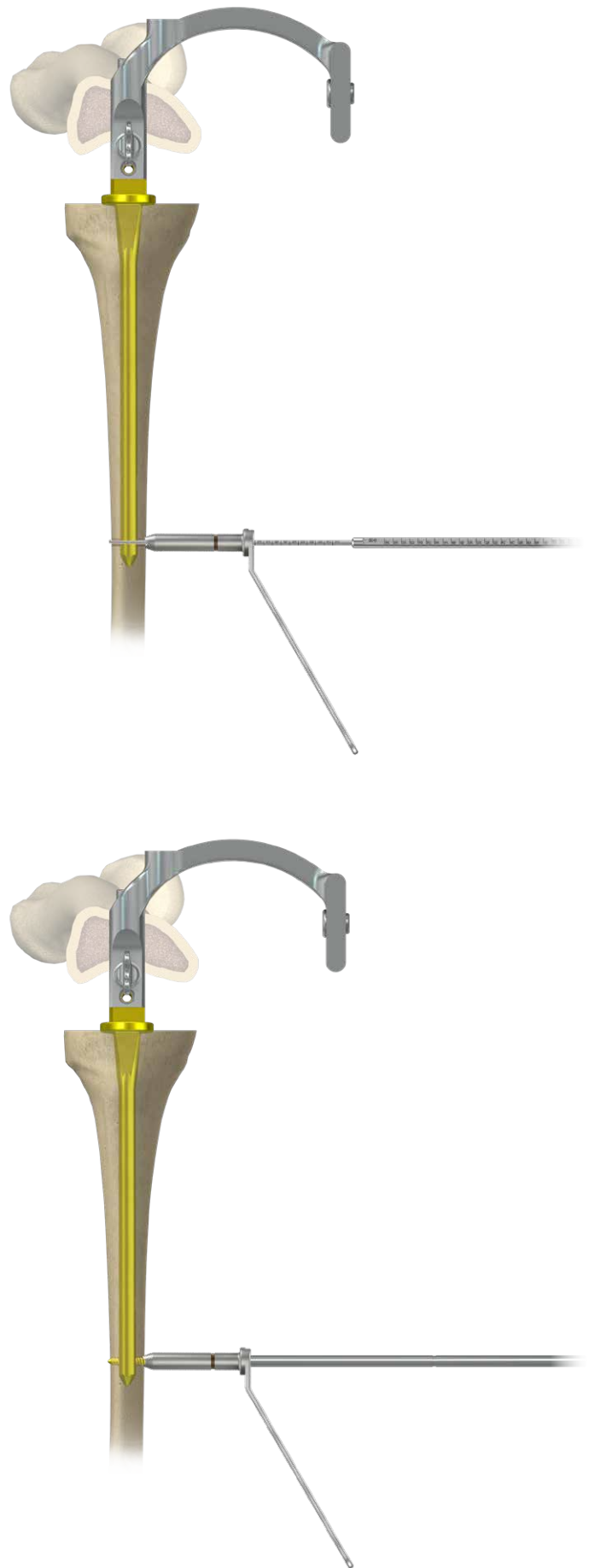
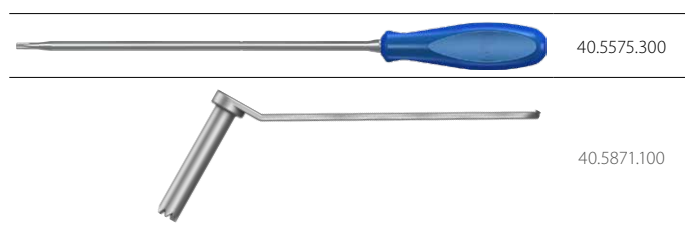

IV.B.5. INSERTION OF CHARFIX2 FN NAIL - FEMUR

IV.B.5.1. Initial CHARFIX2 FN Distance selection

Before opening the medullary canal of the femur, the length of the distance should be pre-selected.

Insert trials 10; 20; 30 [40.6638÷40.6640] to determine the distance between the femur and the tibia and correct length of the limb.

Remove trials.

IV.B.5.2. Opening of the medullary canal of the femur

Use the curved awl 8.0 [40.5523.100] to open the medullary canal.

Attach the guide rod 3.0/580 [40.3925.580] to the guide rod handle [40.1351.100] and using the curved awl, insert into the medullary canal.

Remove the handle and curved awl.

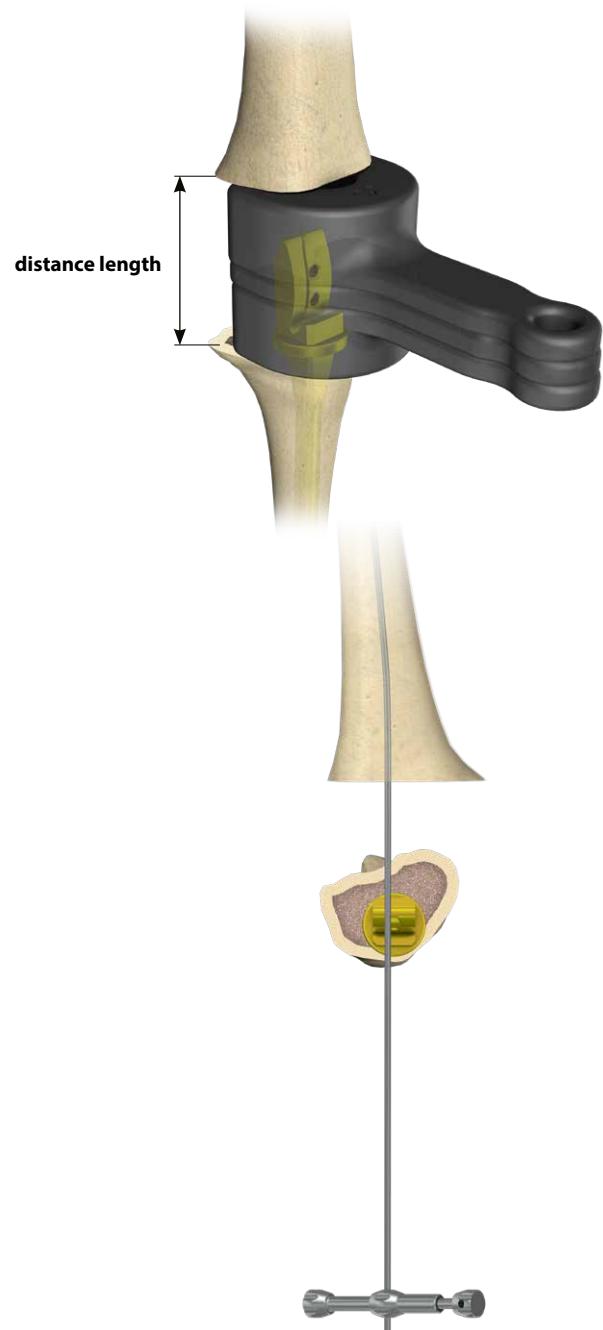
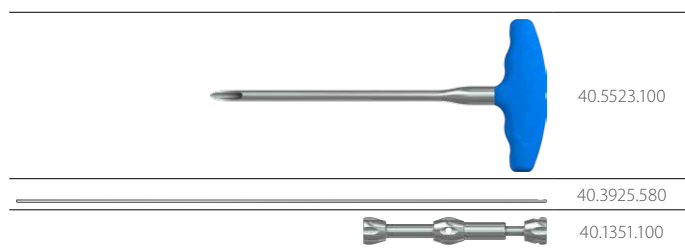

Attach cannulated drill 12/3.0 **[40.5314]** to the drive and using the protective guide **[40.5315.100]**, deepen the entry point in the medullary canal.

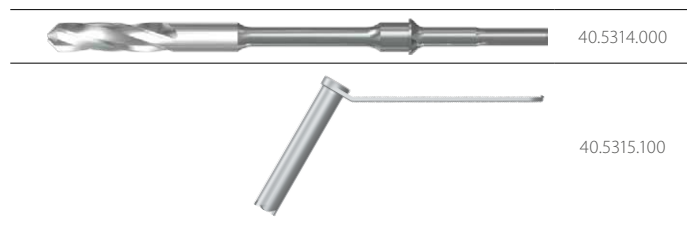

Afterwards, attach the flexible reamer to the drive. Widen the femoral medullary canal gradually until the canal diameter is 1.0 ÷ 1.5mm larger than the diameter of the selected nail.

Use the guide rod 3.0/580 [40.3925.580] to introduce the nail length measure [40.6641,000].

Use the scale on the measure described as "Nail length with distance" at "FEMUR+distance length" side of the measure. The beginning of the measure should be placed in the nail entry point on the bone. Read the length of the nail on the scale provided.

To determine the length of CHARFIX2 FN Nail - femur, add the length of the pre-selected CHARFIX2 FN Distance to the indicated by the guide rod value on the scale (step IV.B.5.1).

Remove the measure and guide rod.

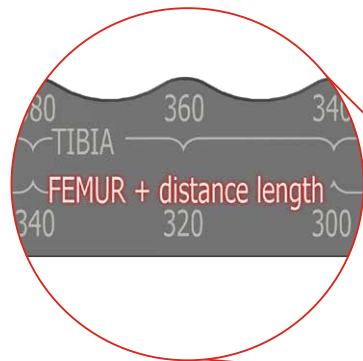

distance length

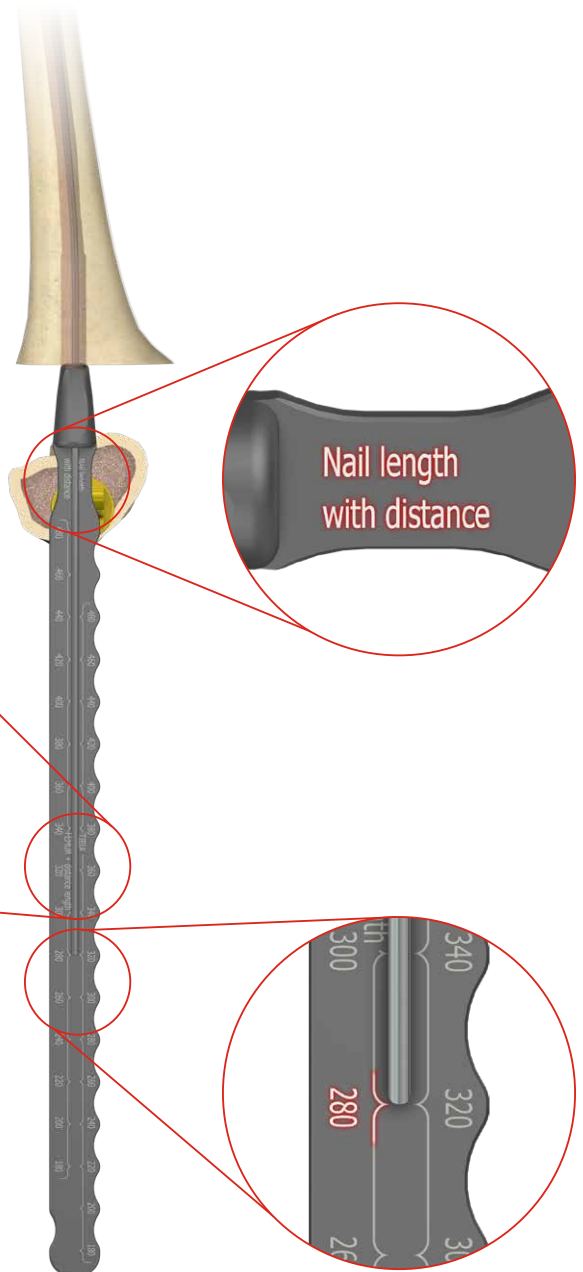
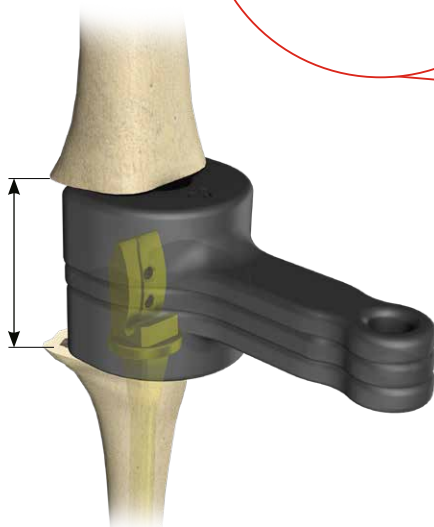

Use countersink [40.6631] to deepen the entry point to the medullary canal.

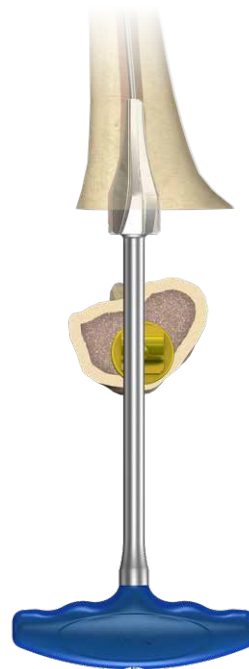
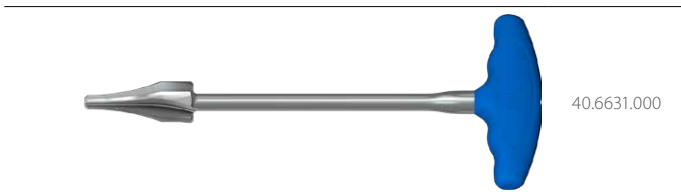

IV.B.5.3. Nail insertion

Prior to nail insertion, determine the position of the slider of the distal targeter **[40.6637]** in relation to the nail holes.

Attach **CHARFIX2 FN** Nail - femur to the targeter arm **[40.6636]**. Using screwdriver T25 **[40.5575.300]**, loosen the locking screws of the slider (*allowing the slider to move*) and move it near the holes in the distal part of the nail.

Determine the correct position of the targeter slider in relation to the nail holes in the distal part using two set blocks 9/5,0 **[40.5509.200]**.

Lock the targeter slider with the screws using screwdriver T25.

Remove set blocks.

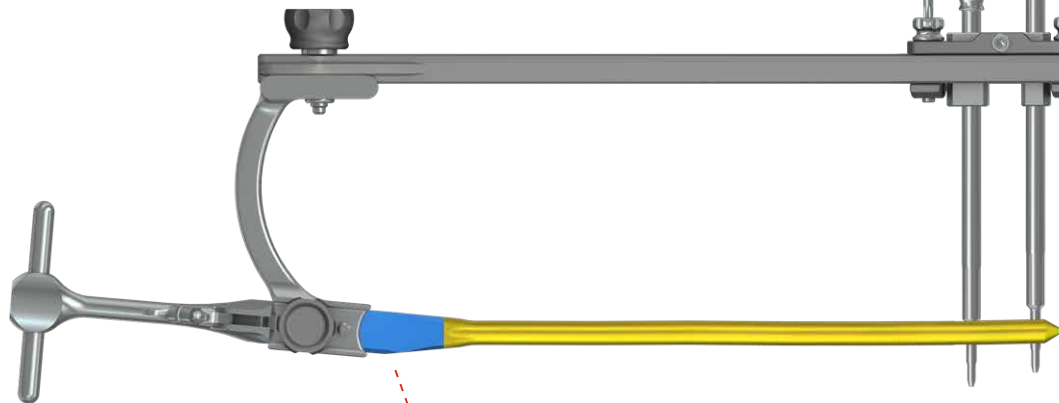
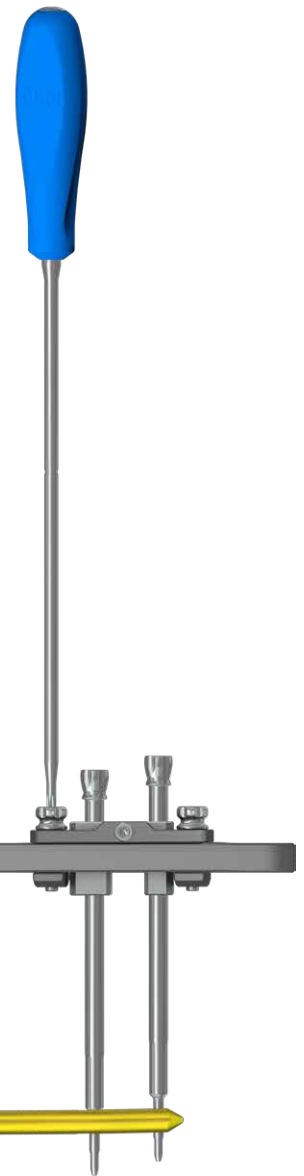
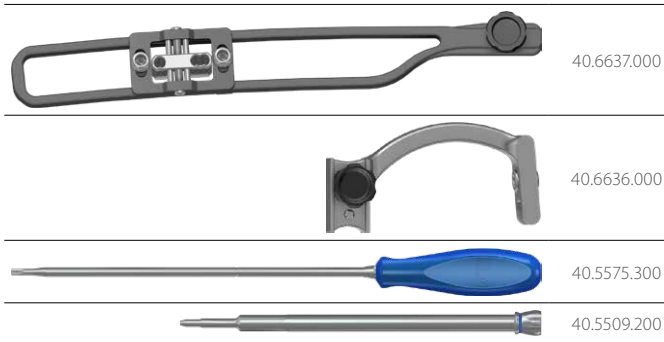

VERIFY: if the targeter slider is properly set and locked, the set blocks should pass through nail holes.

Remove distal targeter [40.6637] from the targeter arm [40.6634].

Attach the handle [40.6632] to CHARFIX2 FN Nail - femur.

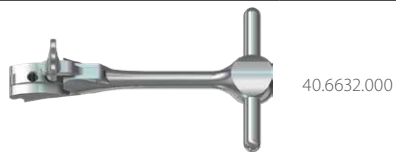

Attach impactor-extractor [40.5507.100] to the handle. Use mallet [40.3667] to insert the implant into the bone.

Remove the handle and impactor-extractor from the nail.

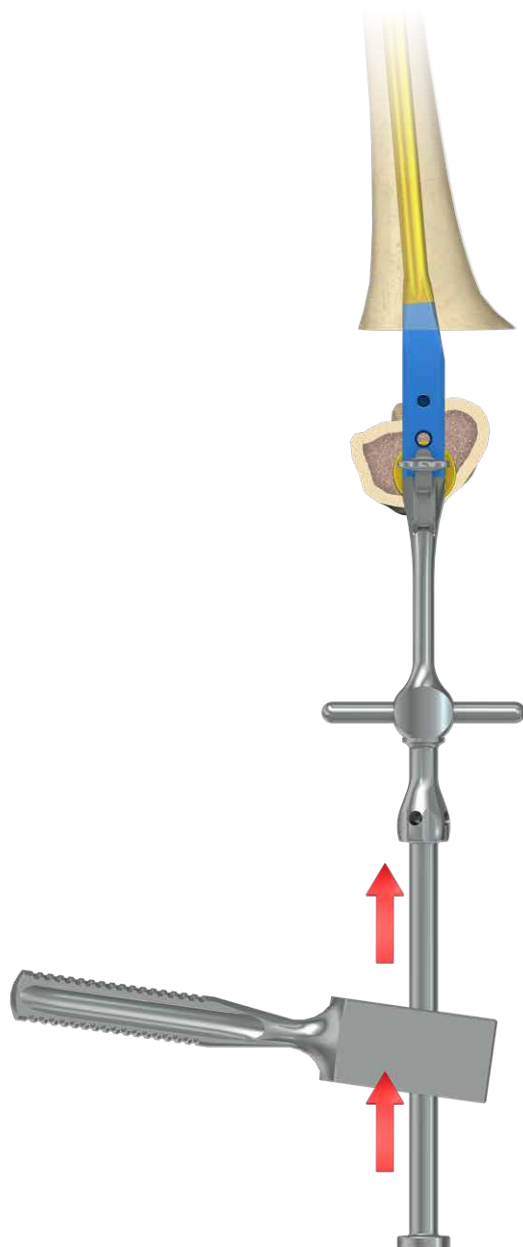

IV.B.6. JOINING CHARFIX2 FN NAIL - FEMUR AND CHARFIX2 FN NAIL - TIBIA

Having inserted both implants, join them the way presented, connecting the tibial with femoral part.

If the both implant cannot be joined due to the lack of a proper distance between them, this distance should be adjusted by maneuvering **CHARFIX2 FN** Nail - femur. Attache the handle **[40.6632]** to the implant and move it back or forth.

When both implants are connected, insert **CHARFIX2 FN** Screws T **[3.6300]**. Use the screwdriver T25 **[40.5575.300]** and insert the screw into the first hole from the tibia. The other hole will be used by the targeter - leave it empty.



If locking of the nail is performed using "free hand" technique, two **CHARFIX2 FN** Screws T **[3.6300]** should be inserted.

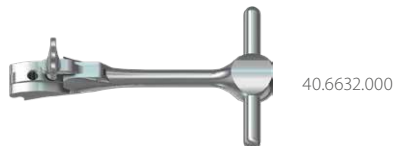

40.6632.000



40.5575.300

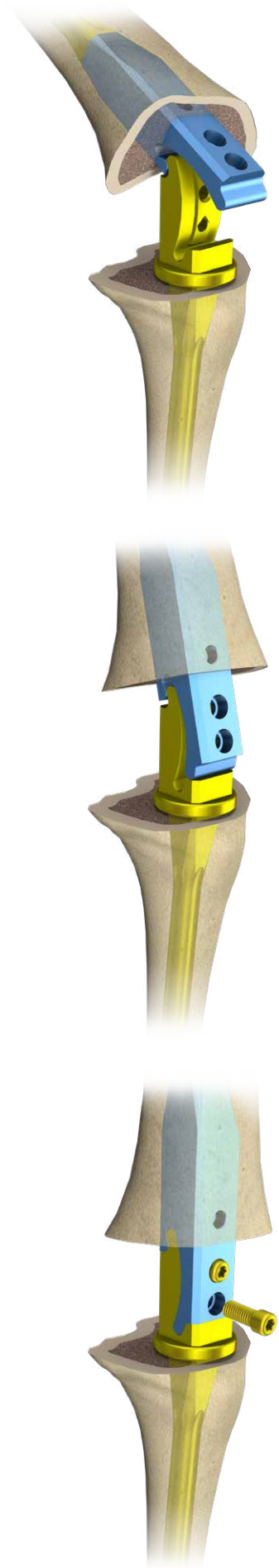

IV.B.7. CHARFIX2 FN DISTANCE INSERTION AND CHARFIX2 FN NAIL - FEMUR LOCKING

Use trials 10, 20 and 30 [40.6638÷40.6640] to determine the distance between the femoral and tibial bones. Determine the correct length of the limb.



On the basis of the measured distance, place the distance elements [3.6367.060÷3.6367.120] posterior. Push the femoral and tibial part of the limb to the distance.

Attach the targeter arm [40.6636] with distal targeter [40.6637] to the free hole in the CHARFIX2 FN Nail - femur.

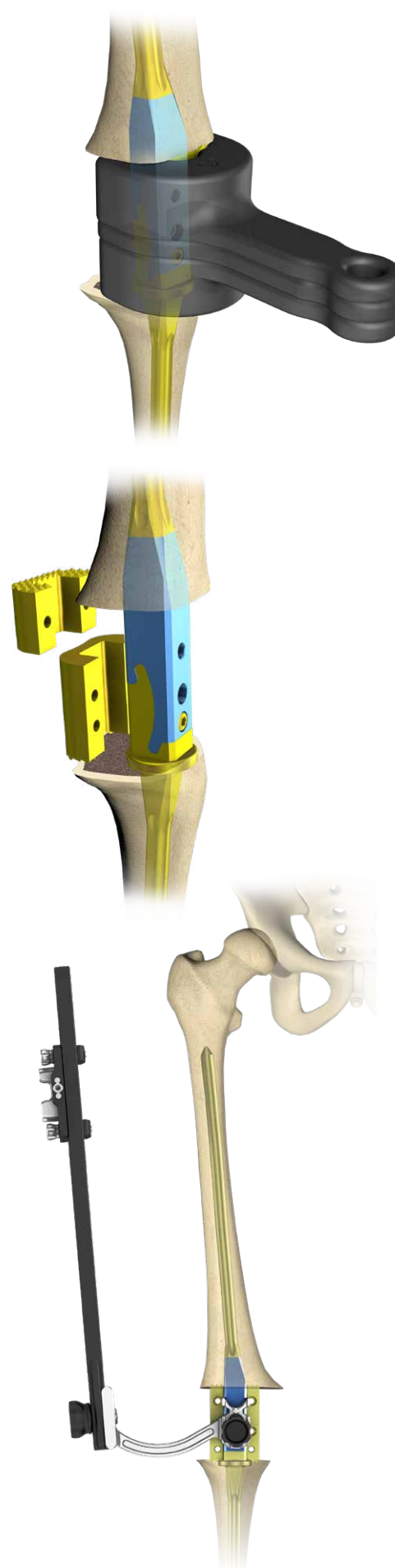
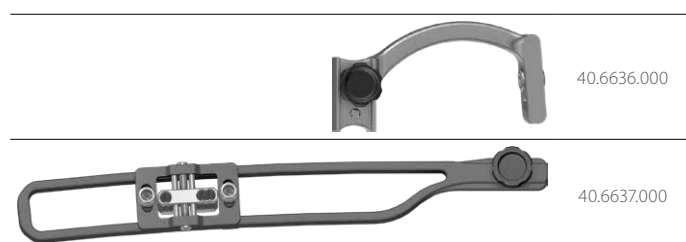

Insert the protective guide 9/7 [40.5510.300] and trocar 6.5 [40.5534.200] into the distal hole of the distal targeter slider. Mark the entry point for a locking screw on the skin and make an incision of soft tissues.

Push the protective guide and trocar to the bone and mark the entry point for a drill.

Remove the trocar.



Insert the drill guide 7/3.5 [40.5511.300] into the protective guide. Use a drive and the drill with scale 3.5/350 [40.5339.002], guided in the drill guide, to drill a hole in the femur through both cortical layers and the hole in the nail. The scale on the drill indicates the length of the locking element.

Remove the drive, leave the drill with guides in place.

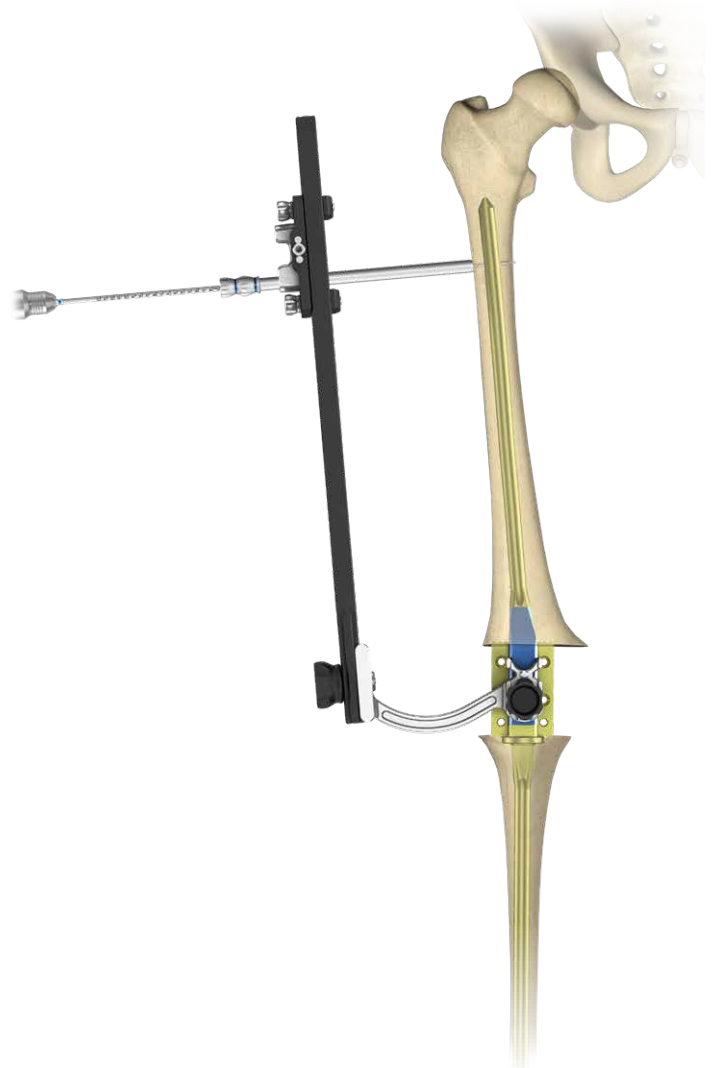
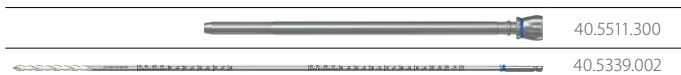

Insert the protective guide 9/7 [40.5510.300] and trocar 6.5 [40.5534.200] into the other hole of the distal targeter slider. Mark the entry point for the locking screw on the skin and make the incision of soft tissues.

Push the protective guide and trocar to the bone and mark the entry point for the drill.

Remove the trocar.

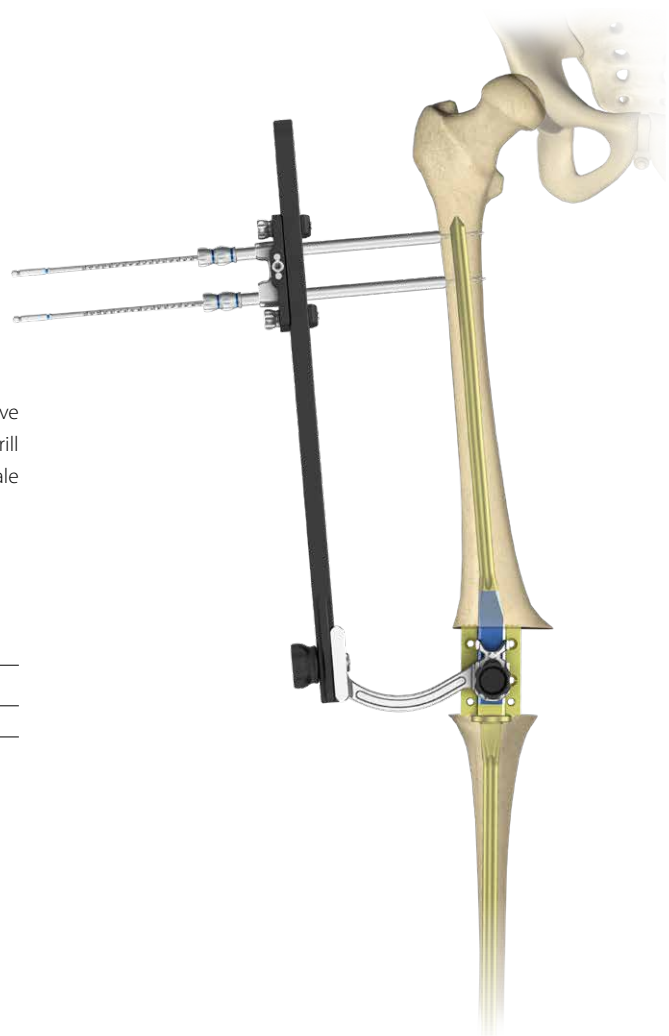
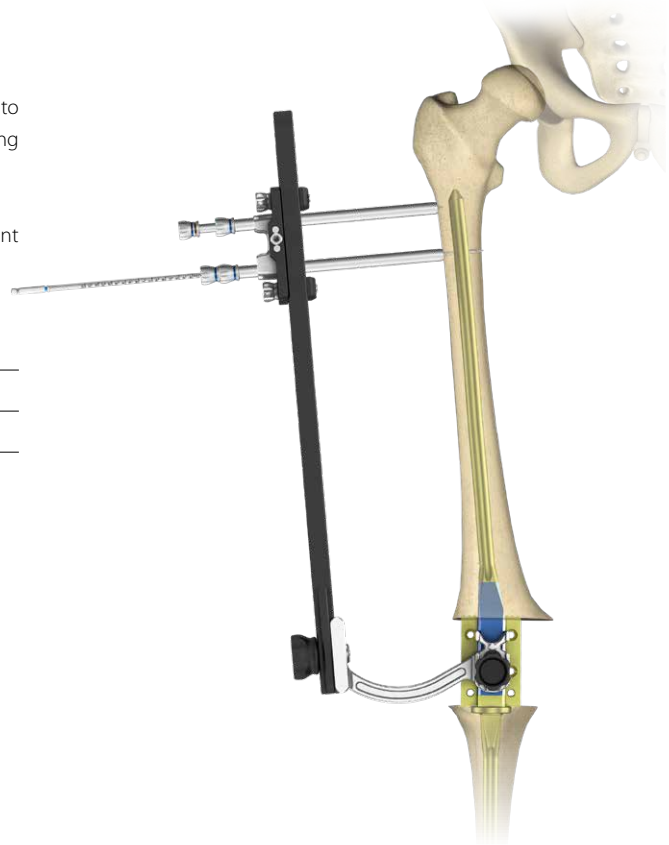

Insert the drill guide 7/3.5 [40.5511.300] into the protective guide. Use the drive and the drill with scale 3.5/350 [40.5339.002], guided in the drill guide, to drill a hole in the femur through both cortical layers and the hole in the nail. The scale on the drill indicates the length of the locking element.

Remove the drill and the drill guide.

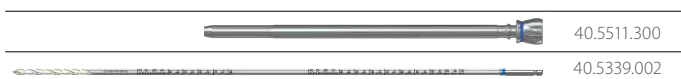

Using the protective guide 9/7 [40.5510.300], insert the screw length measure [40.5530.400] into the drilled hole until its hook reaches the "exit" plane of the hole. Read the length of the locking screw on the scale. During measurement, the protective guide should be pressed against the bone.

Remove the screw length measure.
Leave the protective guide in place.

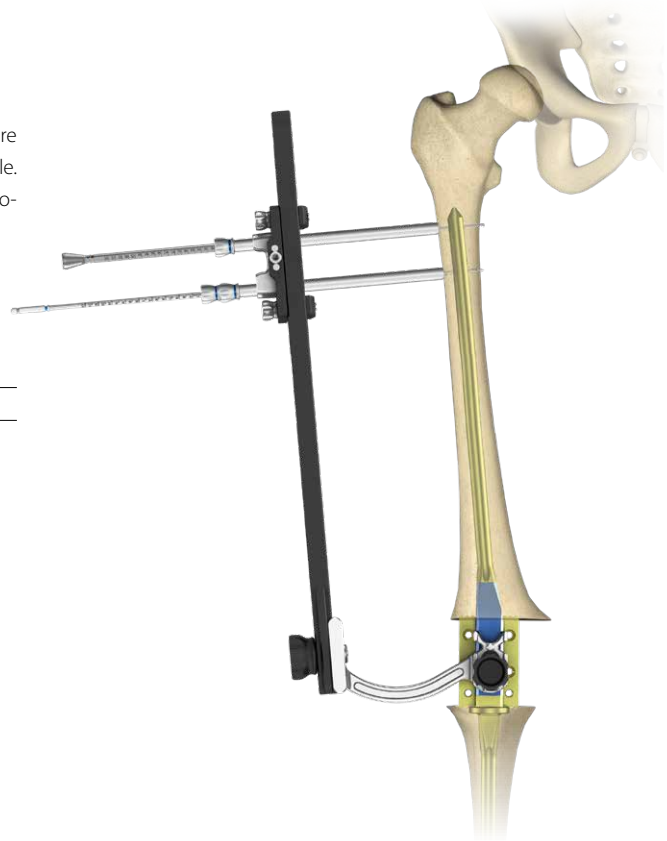
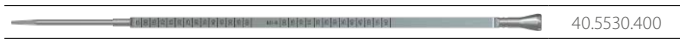

Insert the tip of the screwdriver T25 [40.5575.300] into the socket of the determined locking screw and then, through the protective guide, into the drilled hole, until the head of the screw reaches the bone (*the mark on the screwdriver shaft shall match the edge of protective guide*).

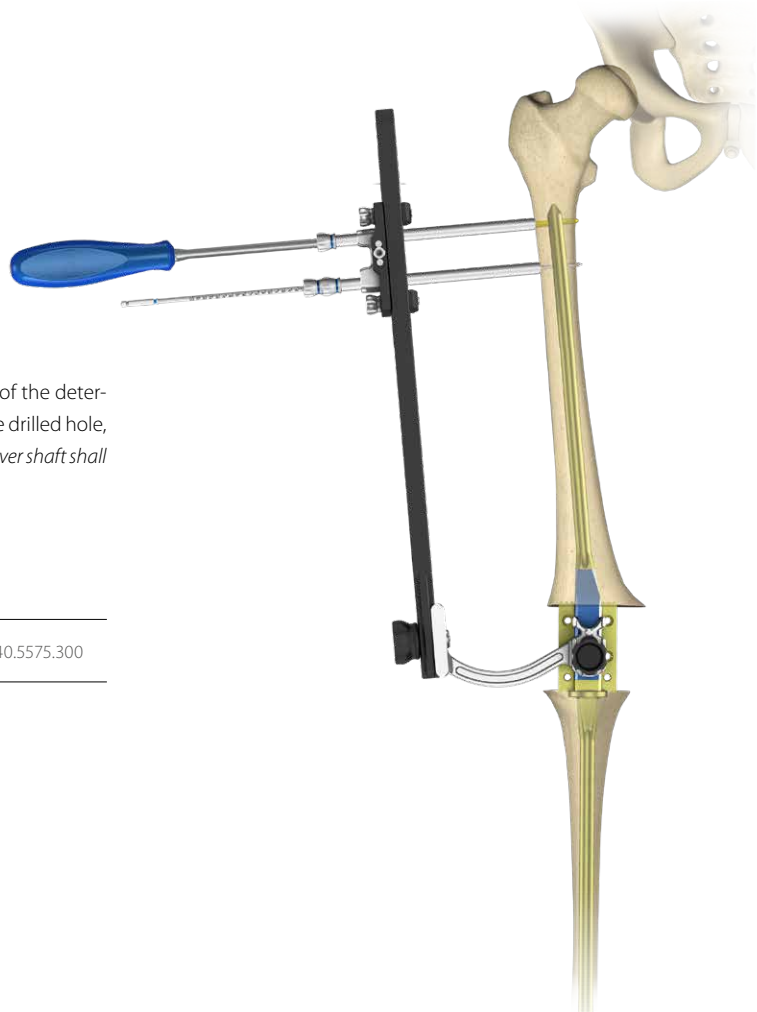

Remove drill with scale 3.5/350 [40.5339.002] and drill guide 7/3.5 [40.5511.300] from the distal hole of distal targeter slider. Leave protective guide 9/7 [40.5510.300] in the slider. Insert screw length measure [40.5530.400], through the protective guide, into the drilled hole, until the hook of the measure reaches the "exit" plane of the hole.

Read the length of the locking screw on the scale. During measurement, the protective guide should be pressed against the bone.

Remove the screw length measure.

Leave the protective guide in place.

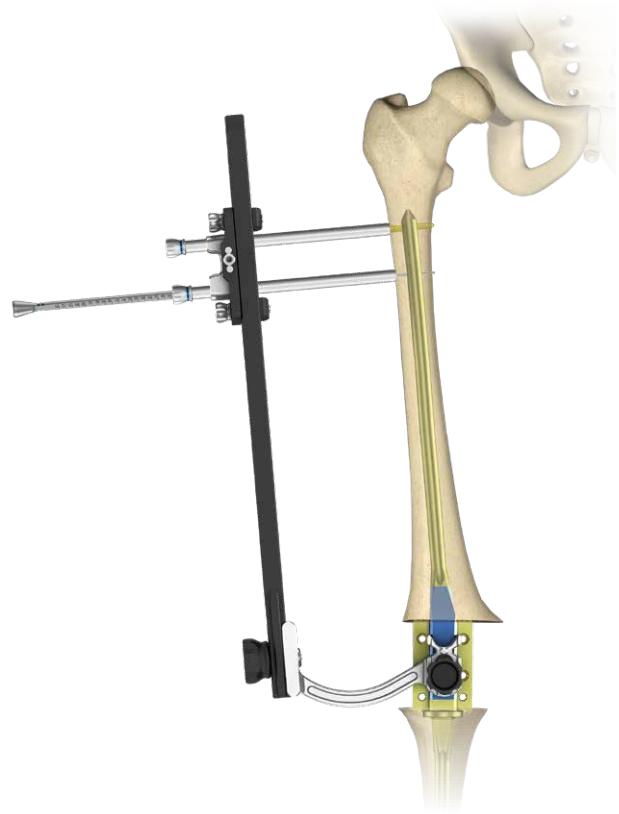
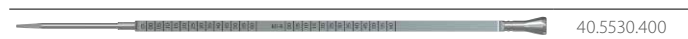

Insert the tip of the screwdriver T25 [40.5575.300] into the socket of the determined locking screw and then, through the protective guide, into the drilled hole, until the head of the screw reaches the bone (*the mark on the screwdriver shaft shall match the edge of protective guide*).

Remove the screwdriver and protective guides.

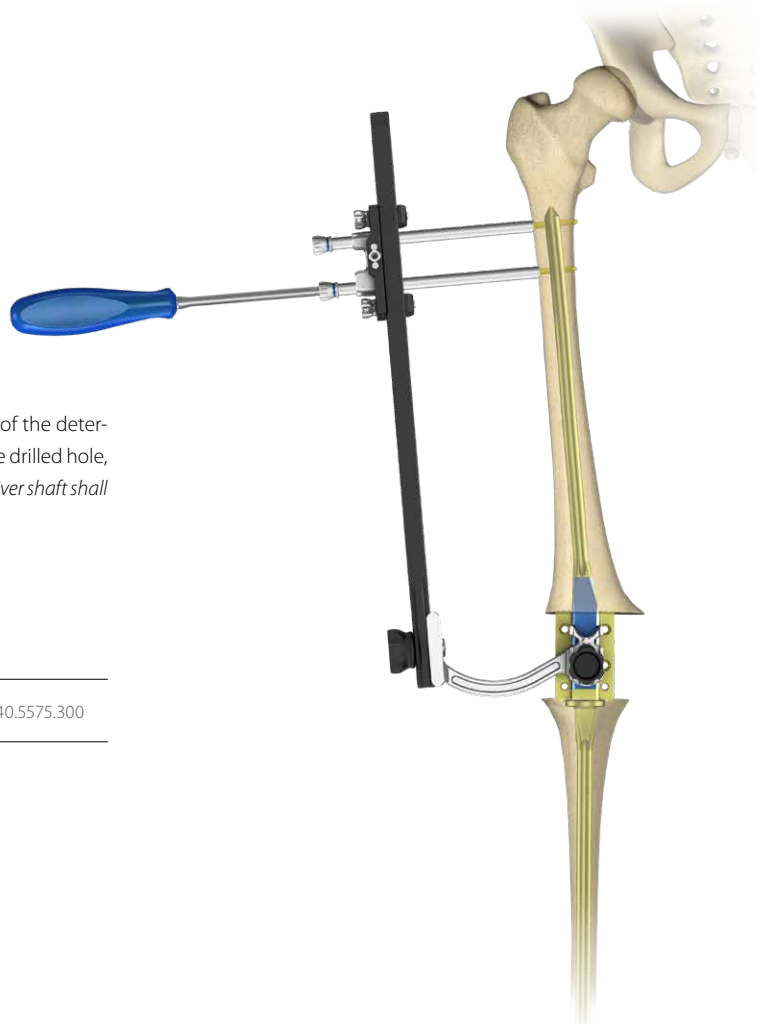

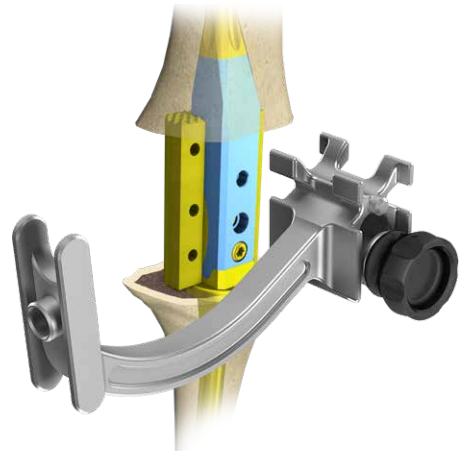

Having locked the **CHARFIX2 FN** Nail - femur, remove the distal targeter with targeter arm, insert the other screw that joins two implants and then, place the anterior part of the distance to the posterior part and connect the two parts using **CHARFIX2 FN** Screws T [3.6300] and screwdriver T25 [40.5575.300].

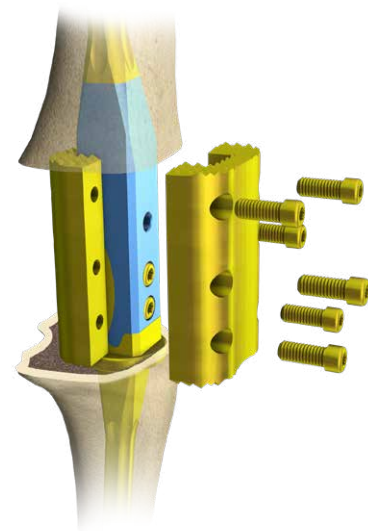

IV.B.8. NAIL LOCKING USING "FREE-HAND TECHNIQUE"

Use two **CHARFIX2 FN Screws T [3.6300]** and screwdriver T25[**40.5575.300**] to connect **CHARFIX2 FN Nail - femur** and **CHARFIX2 FN Nail - tibia**.

On the basis of the measured distance, place the distance elements [**3.6367.060÷3.6367.120**] posterior. Push the femoral and tibial part of the limb to the distance. Place the anterior part of the distance and connect the two parts using **CHARFIX2 FN Screws T [3.6300]** and screwdriver T25 [**40.5575.300**].

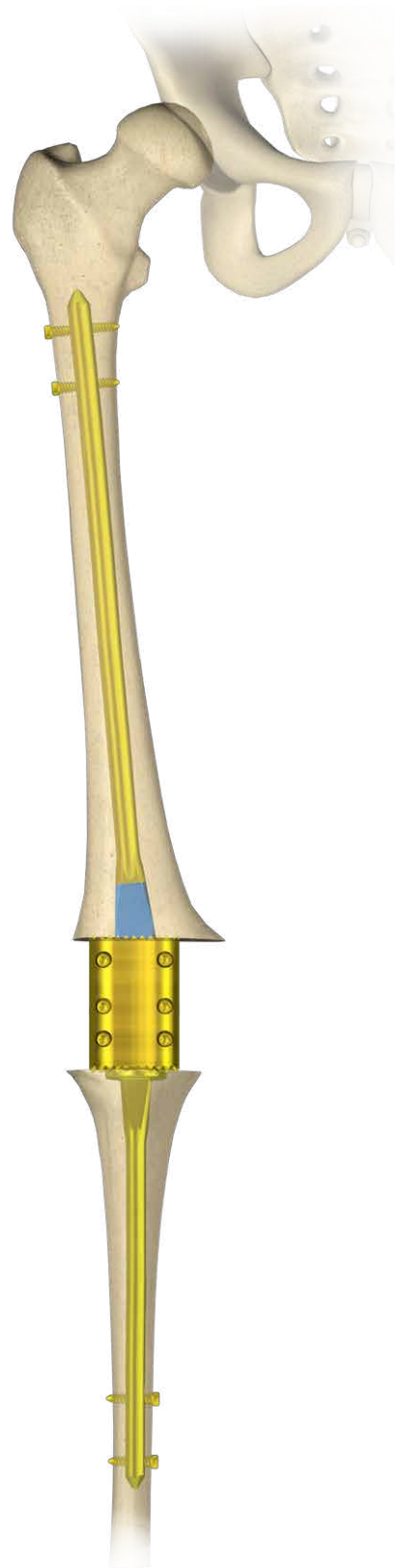
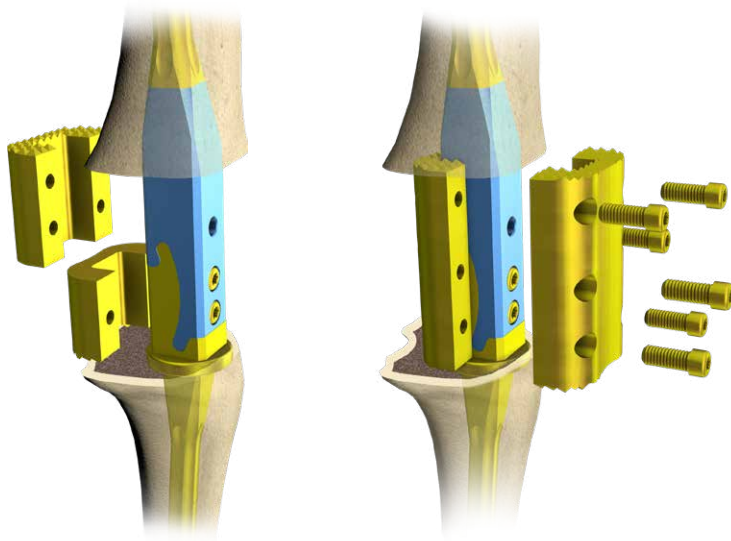

The radiological control is necessary to determine the drilling location of the holes and drilling procedure itself.

It is recommended to use an angular drill attachment for drilling holes, so that the operator's hands are outside the direct X-Ray exposure. Mark on the skin the points for drill insertion and perform incisions of soft tissues passing through these points for about 1.5 cm. Use the X-Ray device to position the protective guide short [**40.5871.100**] in relation to the hole in the nail.



The locking of **CHARFIX2 FN Nail - femur** should be performed in accordance with chapter IV.A.6 (**CHARFIX2 FN NAIL - FEMUR - DISTAL LOCKING**).



40.5871.100

IV.B.9. IMPLANT REMOVAL

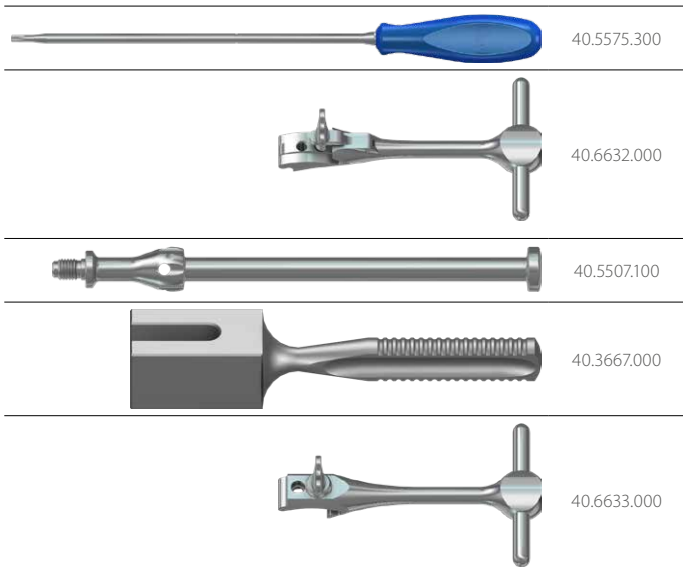

Use screwdriver T25 [40.5575.300] to remove screws locking the **CHARFIX2 FN** Nail - femur and **CHARFIX2 FN** Nail - tibia.

Use screwdriver T25 [40.5575.300] to remove **CHARFIX2 FN** Screws T [3.6300] that connect the posterior and anterior parts of the distance. Remove the **CHARFIX2** Distance [3.6367.060÷3.6367.120].

Use screwdriver T25 [40.5575.300] to remove **CHARFIX2 FN** Screws T [3.6300] that join the **CHARFIX2 FN** Nail - femur and **CHARFIX2 FN** Nail - tibia. Detach the two nails.

Attach the handle [40.6632] to the **CHARFIX2 FN** Nail - femur. Attach the impactor-extractor [40.5507.100] to the handle and using the mallet [40.3667], remove the implant from the bone.

Attach the handle [40.6633] to the **CHARFIX2 FN** Nail - tibia. Attach the impactor-extractor [40.5507.100] to the handle and using the mallet [40.3667], remove the implant from the bone.

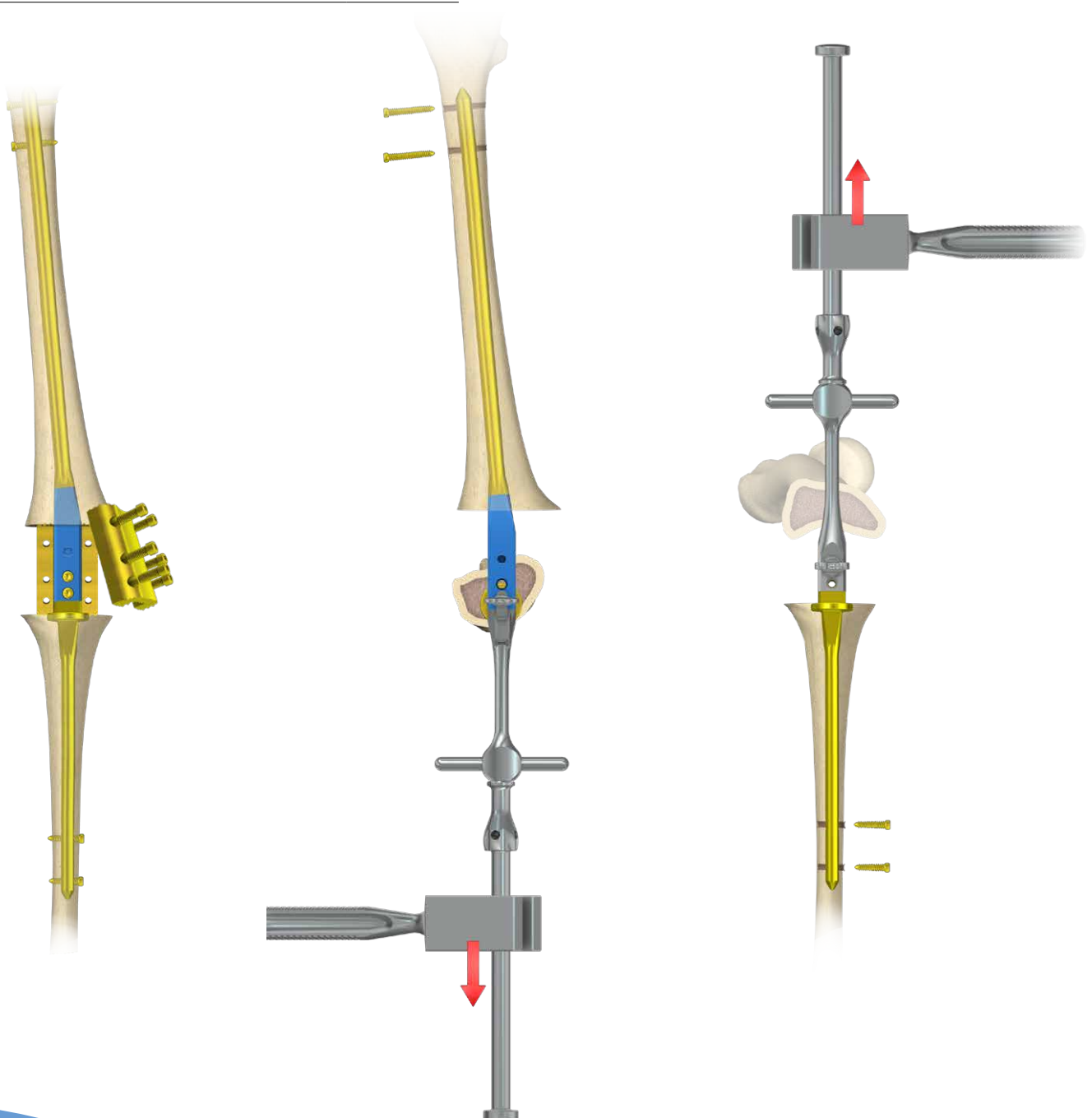

ChM sp. z o.o.

Lewickie 3b
16-061 Juchnowiec Kościelny
Poland

tel. +48 85 86 86 100

fax +48 85 86 86 101

chm@chm.eu

www.chm.eu



CE 0197