

# ChM<sup>®</sup>

5.0 ChM Locked Plating  
ChLP system

## 5.0ChLP distal humerus plates

3.7036; 3.7037

3.7038; 3.7039

3.7040; 3.7041







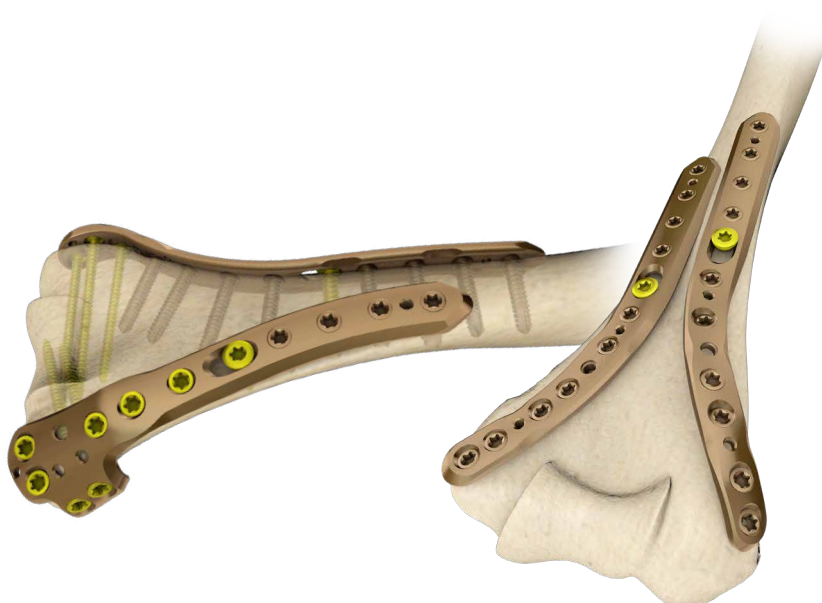



















3.7072; 3.7071

3.7074; 3.7073

- *IMPLANTS*
- *INSTRUMENT SET*
- *SURGICAL TECHNIQUE*



SYMBOLS DESCRIPTION

	Titanium or titanium alloy		H length [mm]
	Cobalt		Angle
	Left		available lengths
	Right		Available number of holes
	Available versions: left/right		Thickness [mm]
	Length		Scale 1:1
	Torx drive		Number of threaded holes in the shaft part of the plate
	Torx drive cannulated		Number of locking holes in the plate
	Hexagonal drive		Variable angle
	Hexagonal drive cannulated		Cortical
	Cannulated		Cancellous
	Locking		Available in sterile/ non- sterile condition
	Diameter [mm]		Refer to surgical technique



Caution - pay attention to a special procedure.



Perform the activity under X-Ray control.



Information about the next stages of a procedure.



Proceed to the next stage.



Return to the specified stage and repeat the activity.



Before using the product, carefully read the Instructions for Use. It contains, among others, indications, contraindications, side effects, recommendations and warnings related to the use of the product.



The above description is not a detailed instruction of conduct. The surgeon decides about choosing the operating procedure.

**www.chm.eu**

Document No ST/80-511  
 Date of issue 24.06.2019  
 Review date P-001-08.12.2020

The manufacturer reserves the right to introduce design changes.  
 Updated INSTRUCTIONS FOR USE are available at the following website: ifu.chm.eu

<b>1. INTRODUCTION</b>	<b>5</b>
<b>2. IMPLANT DESCRIPTION</b>	<b>6</b>
<b>3. SURGICAL TECHNIQUE</b>	<b>9</b>
3.1. PATIENT'S POSITIONING	9
3.2. DOSTĘP OPERACYJNY	9
3.3. FRACTURE REDUCTION	9
3.4. IMPLANT SELECTION	9
3.5. USE OF AIMING BLOCK	10
3.6. PLATE INSERTION	10
3.7. CORTICAL SCREW INSERTION	10
3.8. TEMPORARY PLATE STABILIZATION	10
3.9. LOCKING SCREWS INSERTION IN THE EPIPHYSEAL PART OF THE PLATE	11
3.10. AIMING BLOCK REMOVAL	11
3.11. LOCKING SCREWS INSERTION IN THE SHAFT PART OF THE PLATE	12
3.12. WOUND CLOSURE	12
<b>4. SURGICAL PROCEDURES</b>	<b>13</b>
4a. PROCEDURE OF TEMPORARY IMPLANT STABILIZATION	13
4b. PROCEDURE OF CORTICAL SELF-TAPPING SCREW 3.5 [3.1306] INSERTION	14
4c. PROCEDURE OF 5.0ChLP SELF-TAPPING SCREW 3.5 [3.5200] INSERTION	15
4d. PROCEDURE OF 4.5ChLP SCREW 2.4 [3.5225] INSERTION	16
4e. PROCEDURE OF 5.0ChLP SCREW VA 3.5 [4.5236] INSERTION	17
<b>5. POSTOPERATIVE PROCEDURE</b>	<b>19</b>
<b>6. IMPLANT REMOVAL</b>	<b>19</b>
<b>7. CATALOGUE PAGES</b>	<b>20</b>
7a. INSTRUMENT SET	20
7b. IMPLANTS	22
7c. SCREWS	27



## 1. INTRODUCTION

This surgical technique applies to 5.0ChLP locked plating system used for stabilization of distal humerus fractures. The plates are a part of the ChLP locked plating system developed by **ChM**. The presented range of implants is made of materials in accordance with ISO 5832 standards. Compliance with the requirements of quality management systems and the requirements of Directive 93/42/EEC concerning medical devices guarantee high quality of the offered implants.

The system includes:

- implants (*plates and screws*),
- instrument set used in the surgery,
- surgical technique.

### Indications

---

- intra-articular and extra-articular fractures of the distal humerus,
- fractures of the distal humerus extending to the shaft,
- mal-, and non-unions,
- corrective osteotomies.

### Plate selection and shaping

---

The plates are available in different lengths, separately for right and left side. This allows for optimal selection of the implant to the fracture type. Shaping of the plates in their epiphyseal part is not allowed.



Before using the product, carefully read the Instructions for Use. It contains, among others, indications, contraindications, side effects, recommendations and warnings related to the use of the product.



The above description is not a detailed instruction of conduct. The surgeon decides about choosing the operating procedure.

---

## 2. IMPLANT DESCRIPTION

Distal humerus plates are a part of 5.0ChLP system. This system includes also compatible locking screws. To facilitate the identification, both titanium plate and screws are brown anodized.

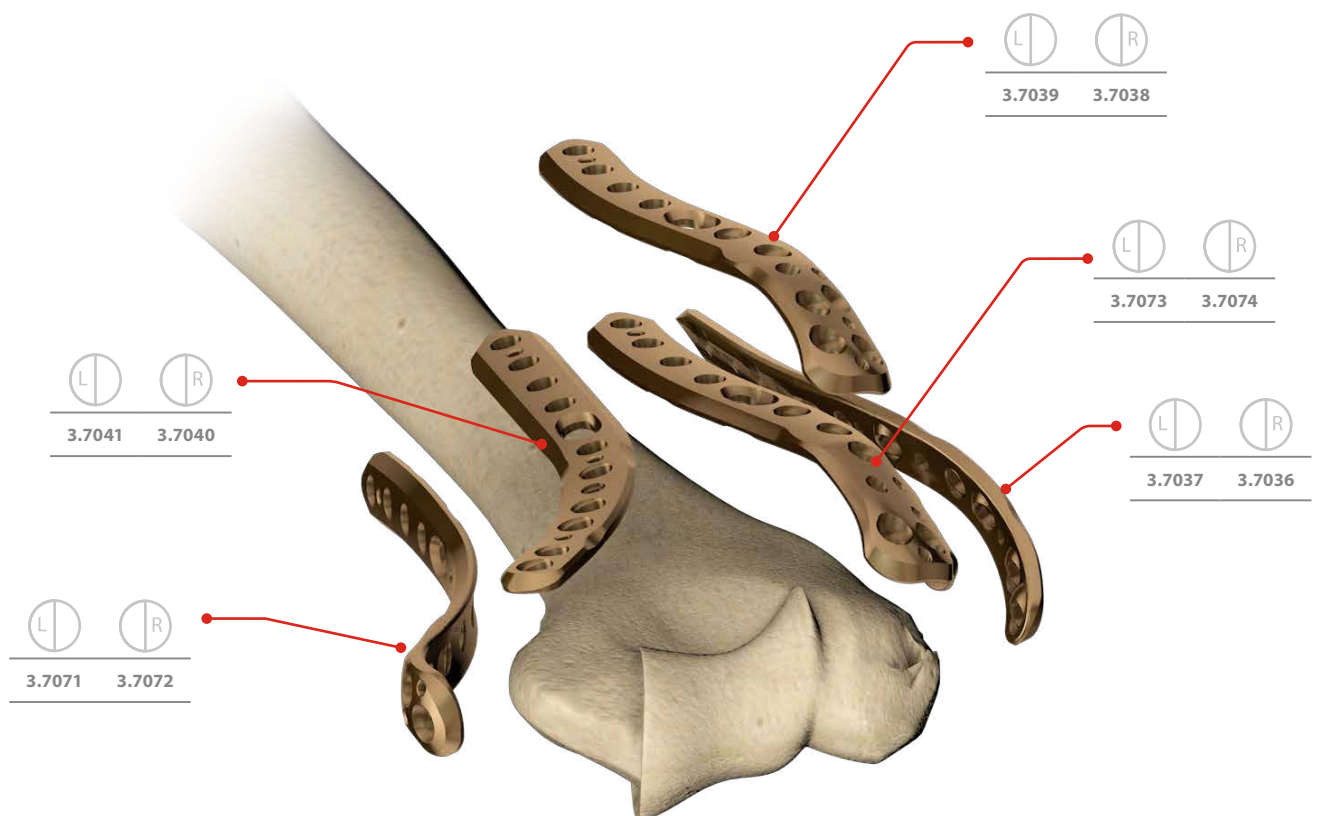

#### Plate design:

- anatomical profile fits the bone structure,
- narrowed epiphyseal part,
- rounded upper edges.

#### Variable plate thickness:

- plate shape fits the anatomy of the humerus.
- reduced risk of irritation of soft tissues and tendons.

#### Aiming blocks:

- fast, collision-free insertion of screws in the pre-defined directions.

#### New locking hole design:

- the screws heads do not protrude above the surface of the plate what significantly reduces the irritation of periimplant tissues,
- increased strength of the screw-to-plate threaded connection,
- bottom extrusion reduces surface contact area with the bone.

#### Angularly stable locking holes of a pre-defined direction:

- angular positioning fitting the anatomical bone structure,
- collision-free insertion of screws.

#### Variable profile of the upper edge of the plate:

- plate reinforcement around the locking hole,
- soft edges limiting soft tissue irritation.

#### Oval-shaped hole:

- convenient plate positioning,
- bidirectional compression possibility.

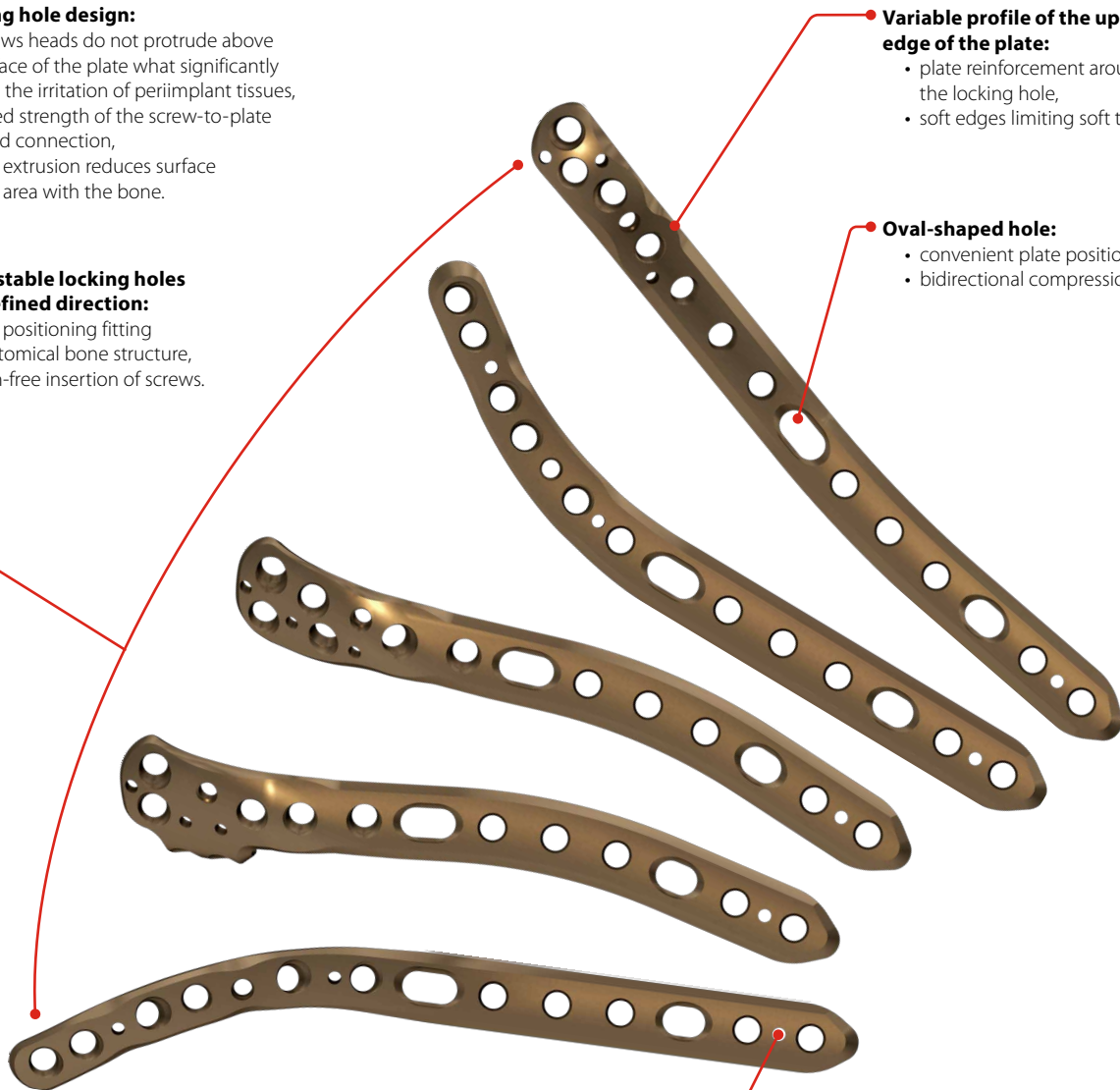

#### Holes for Kirschner wires:

- easier plate positioning,
- temporary plate stabilization.

$90^\circ$   
 3.7040 / 3.7041 + 3.7036 / 3.7037  
 Distal posterior medial humerus plate      Distal lateral humerus plate



$180^\circ$   
 3.7071 / 3.7072 + 3.7036 / 3.7037  
 Distal medial humerus plate      Distal lateral humerus plate



$90^\circ$   
 3.7071 / 3.7072 + 3.7038 / 3.7039  
 Distal medial humerus plate      Distal posterior lateral humerus plate

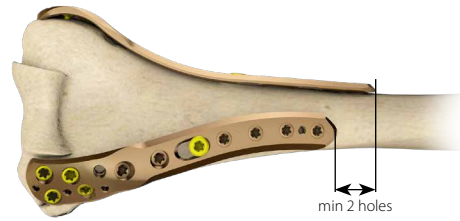

$90^\circ$   
 3.7071 / 3.7072 + 3.7073 / 3.7074  
 Distal medial humerus plate      Distal dorsolateral humerus plate

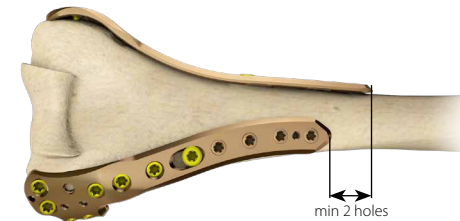



### 3. SURGICAL TECHNIQUE

#### 3.1. PATIENT'S POSITIONING

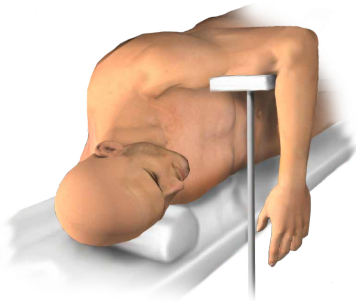

Lateral position



Supine position

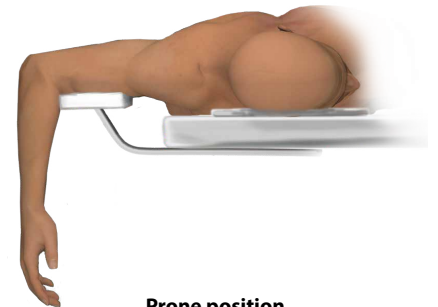

Prone position

#### 3.2. DOSTĘP OPERACYJNY

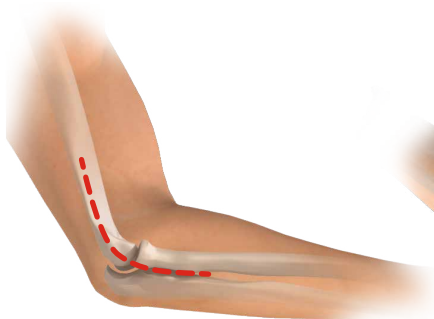

Lateral approach

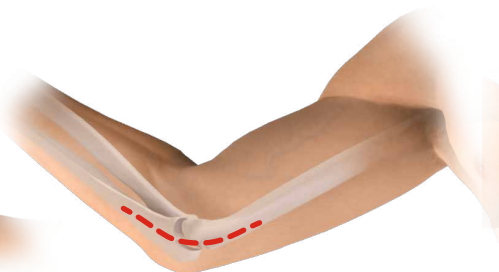

Medial approach

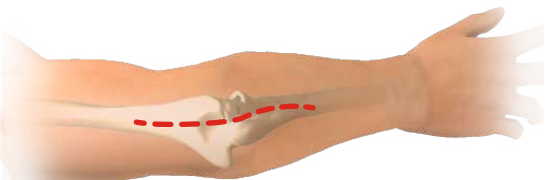

Posterior approach

Particular attention should be paid to the ulnar nerve - expose it.  
Lateral, medial or both accesses simultaneously are used.  
The posterior approach allows for bypassing the olecranon and its osteotomy (*chevron osteotomy*), for better visualization of the fracture site.

#### 3.3. FRACTURE REDUCTION

Perform fracture reduction. If need be, temporarily stabilize the bone fragments with Kirschner wires and/or reduction pliers.



#### 3.4. IMPLANT SELECTION

Select the right size of an implant to the type of fracture, bone size and structure.



**NOTE:** Should stabilization with two plates be used, the implants ought to have different lengths to avoid overloading the humerus shaft. Recommended difference in length - two holes.











Use plate trials to determine the length of the implant.

Plate 3.7036.606 trial Plate 3.7037.606 trial		43.7037.606 43.7037.606
Plate 3.7038.606 trial Plate 3.7039.606 trial		43.7038.606 43.7039.606
Plate 3.7040.606 trial Plate 3.7041.606 trial		43.7040.606 43.7041.606
Plate 3.7071.606 trial Plate 3.7072.606 trial		43.7071.606 43.7072.606
Plate 3.7073.606 trial Plate 3.7074.606 trial		43.7073.606 43.7074.606



### 3.5. USE OF AIMING BLOCK

Attach appropriate aiming block to the plate by tightening the fixing screw of the block using screwdriver tip T15 **[40.5677.000]**.

plate 3.7036		40.8210.000
plate 3.7037		40.8211.000
plate 3.7038		40.8212.000
plate 3.7039		40.8213.000
plate 3.7040		40.8214.000
plate 3.7041		40.8210.000
plate 3.7072		40.8216.000
plate 3.7071		40.8217.000
plate 3.7074		40.8218.000
plate 3.7073		40.8219.000
		40.6654.000
		40.5677.000



Most ChLP locking plates are available with aiming blocks as additional supplementary instruments. The use of aiming blocks ensures proper guide sleeves locking in the plate epiphyseal locking holes. Aiming blocks facilitate also the surgery procedure, shorten its time and ensure drilling in the axis of the locking hole.



Not using aiming blocks may lead to improper device implantation. Incorrectly locked screws can cause complications when removing the plates.

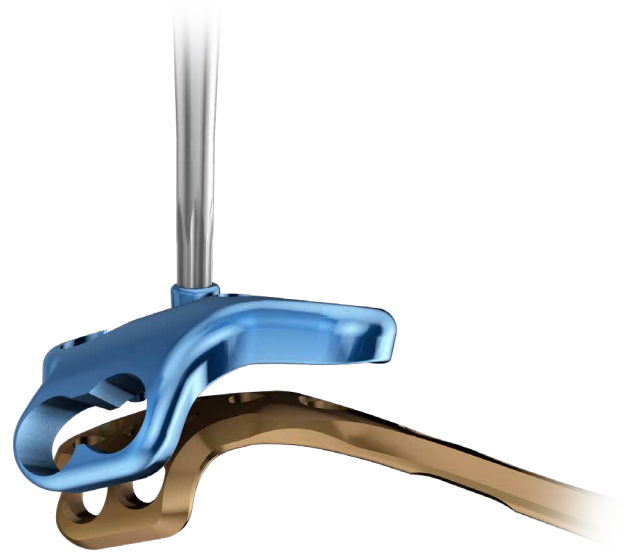

### 3.6. PLATE INSERTION

Position the implant correctly on the bone.

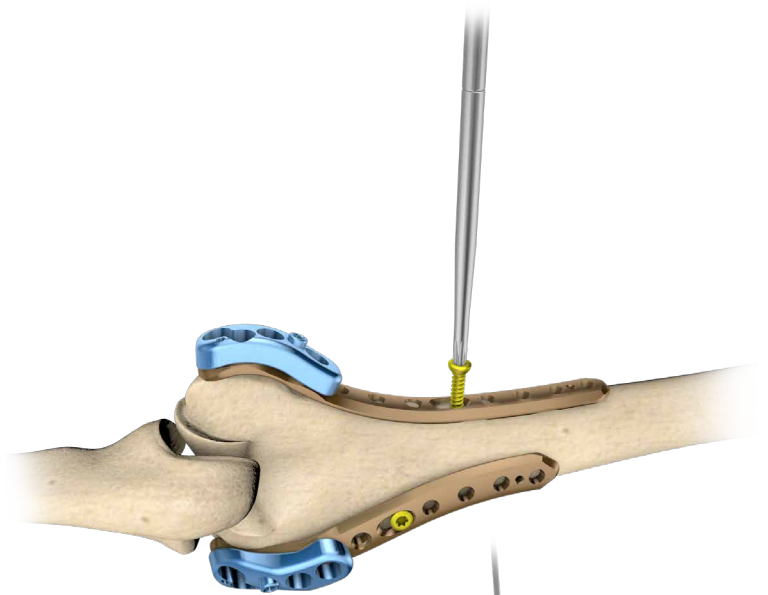

### 3.7. CORTICAL SCREW INSERTION

Insert cortical self-tapping screw 3.5 **[3.1306]** into the oval-shaped hole of the plate (*acc. to procedure 4b*).

### 3.8. TEMPORARY PLATE STABILIZATION

Stabilize the position of the implant inserting Kirschner wires into appropriate holes or using setting-compressing screw (*acc. to procedure 4a*).

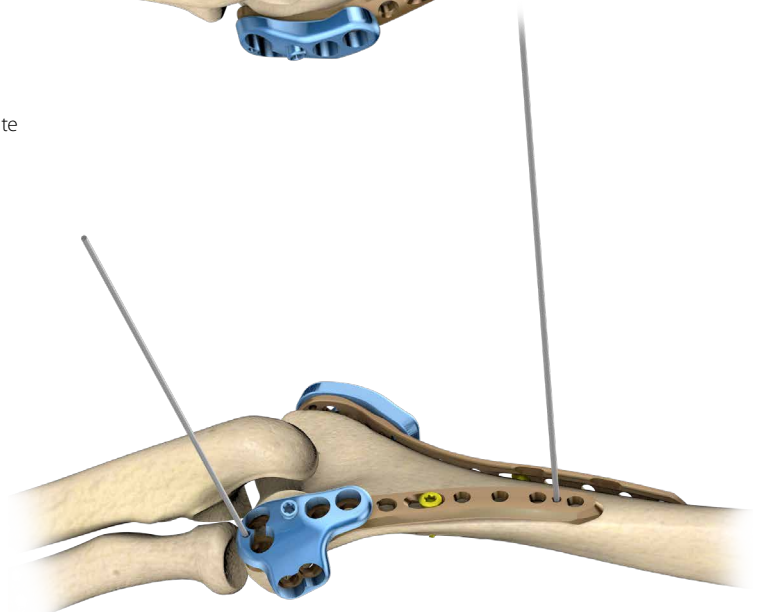

### 3.9. LOCKING SCREWS INSERTION IN THE EPIPHYSEAL PART OF THE PLATE

Insert locking screws of a suitable length, into the locking holes of the plate.

- 5.0ChLP self-tapping screw 3.5 **[3.5200]** (acc. to procedure 4c).
- 4.5ChLP screw 2.4 **[3.5225]** (acc. to procedure 4d).

Insert protective guide 7/5 **[40.5672]** into the aiming block hole.

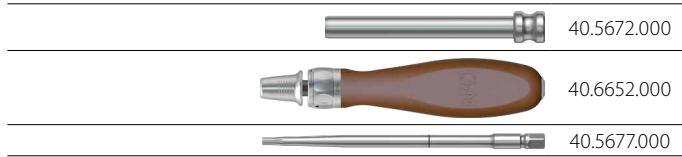

Insert the self-tapping screws through that guide.

- 5.0ChLP screw VA 3.5 **[3.5236]** (acc. to procedure 4e).



**NOTE:** When inserting the screws in the distal part, ensure they do not penetrate the joint surfaces or the bottom of the olecranon.

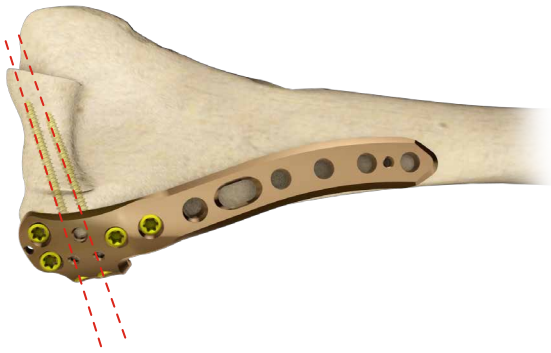

### 3.10. AIMING BLOCK REMOVAL

Use screwdriver tip T15 **[40.5677.000]** to remove the aiming block from the plate

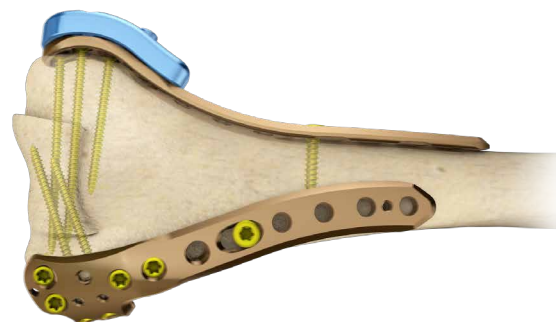
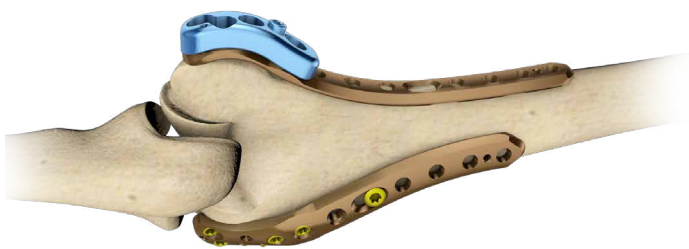
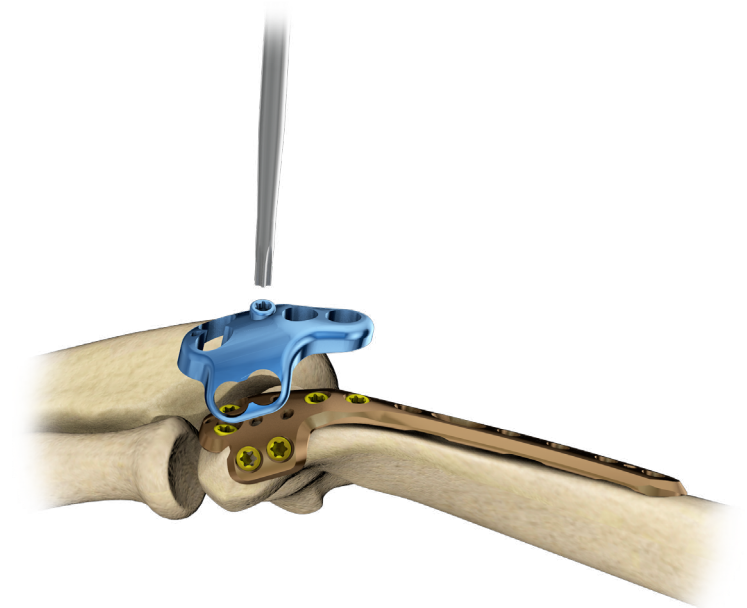
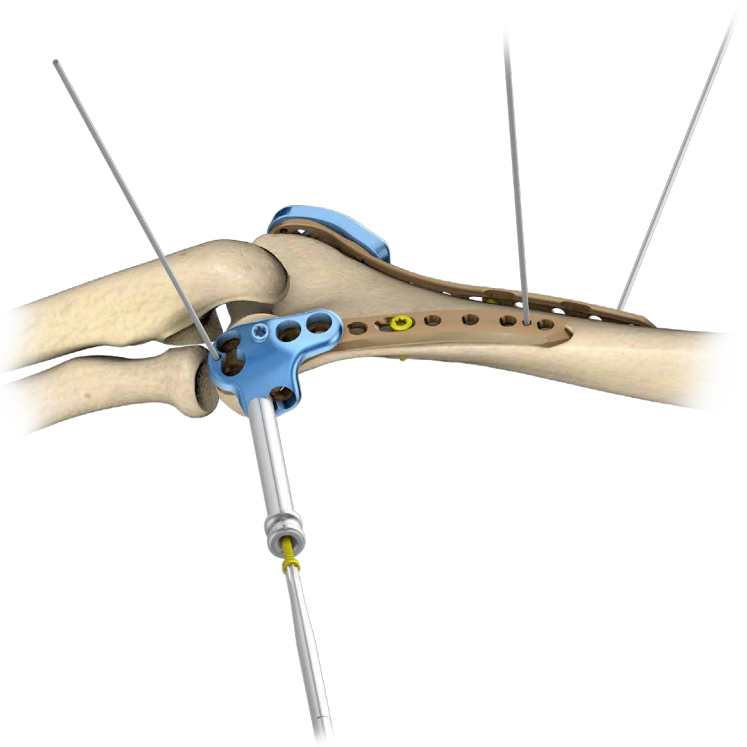
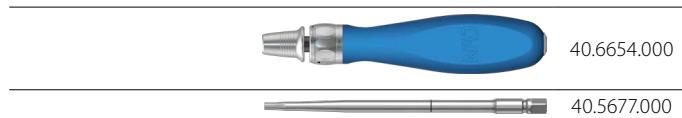

### 3.11. LOCKING SCREWS INSERTION IN THE SHAFT PART OF THE PLATE

Insert 5.0ChLP self-tapping screw 3.5 **[3.5200]** of a suitable length into the locking holes of the shaft part of the plate (*acc. to procedure 4c*)

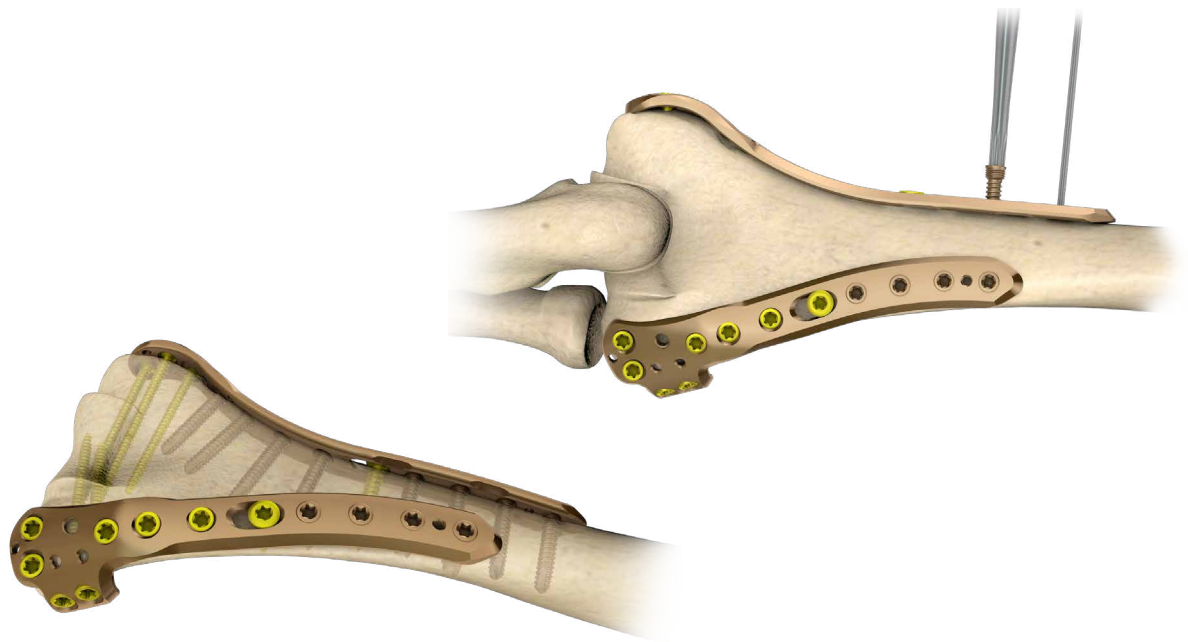

Insert the cortical screws 3.5 into the fracture before inserting the locking screws.



The doctor decides about the order and number of locking and cortical screws to be inserted.

### 3.12. WOUND CLOSURE

Before closing the wound, take an X-Ray image in at least two projections to confirm implant position and fracture reduction. Make sure all the screws are properly tightened and do not penetrate the joint surface.

Use appropriate surgical technique to close the wound.

## 4. SURGICAL PROCEDURES

### 4a. PROCEDURE OF TEMPORARY IMPLANT STABILIZATION

#### Stabilization using Kirschner wires

- Stabilize temporary the implant inserting Kirschner wires 1.5/210 **[40.4592.210]** into dedicated holes in the plate.

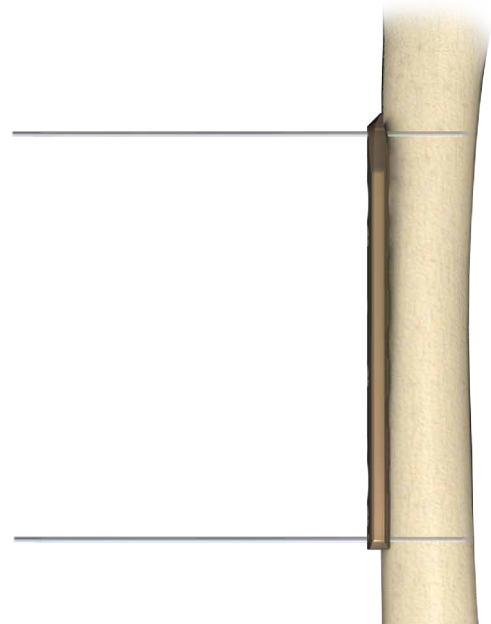

#### Stabilization in locking holes using Kirschner wires

- Insert guide sleeve 5.0/1.8 **[40.5673.718]** into the locking hole of the plate.
- Insert Kirschner wire **[40.4592.210]** through the guide sleeve 5.0/1.8 **[40.5673.718]**.

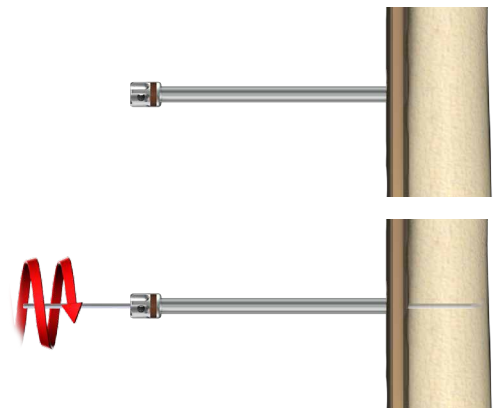
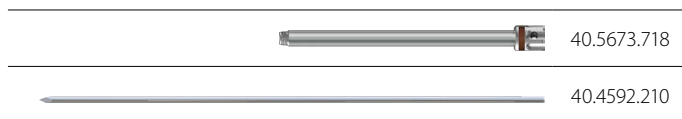

#### Stabilization using setting-compressing screw

- Insert guide sleeve 5.0/2.8 **[40.5673.728]** into the locking hole of the plate.
- Insert setting-compressing screw 2.8/180 **[40.5674.728]** through the guide sleeve 5.0/2.8 **[40.5673.728]**.
- Tighten the nut of the setting-compressing screw **[40.5674.728]** and push the plate to the bone.

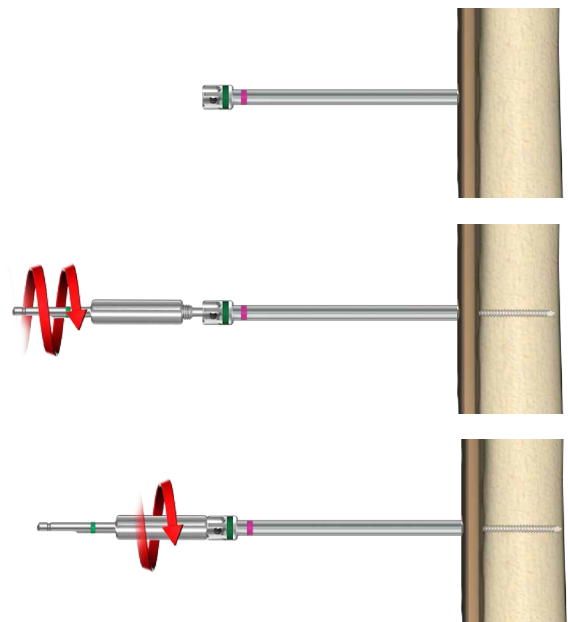
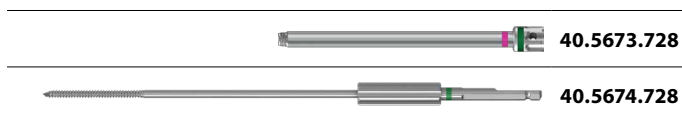

## 4b. PROCEDURE OF CORTICAL SELF-TAPPING SCREW 3.5 [3.1306] INSERTION

### Compression guide positioning

Position the compression guide 2.5 [40.4804.725] in a desired position:



**NEUTRAL POSITION:** Push the guide to the plate. It will position itself so as neutral insertion of the screw is allowed.

**COMPRESSION POSITION:** Do not push the guide and move it to the edge of the compression hole. The hole drilled in this position allows compressive insertion of the screw.

**ANGULAR POSITION:** Angular position of the guide may also be applied.

NEUTRAL POSITION



COMPRESSION POSITION

ANGULAR POSITION

### Hole drilling

Perform a hole through both cortices for a cortical screw 3.5 insertion. For drilling, use drill with scale 2.5/210 [40.5912.212] and compression guide in a desired position.



### Measurement of hole depth

Insert depth measure [40.4639.550] into drilled hole until the hook of the measure rests against the outer surface of the second cortex.



### Screw insertion

Insert cortical screw using handle ratchet device [40.6654.000] and screwdriver tip T15 [40.5677.000].

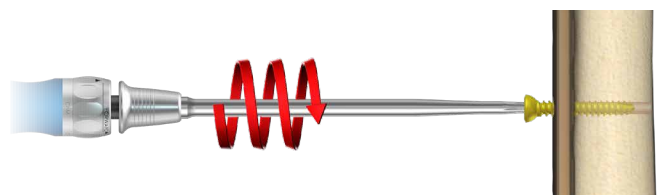
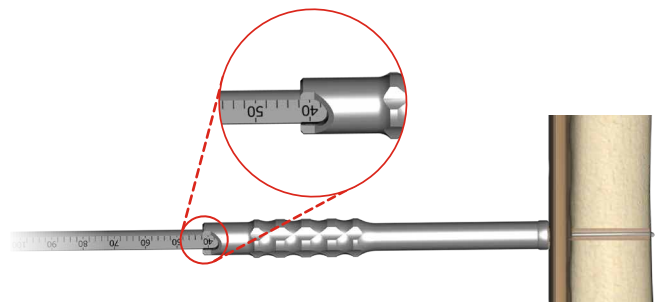
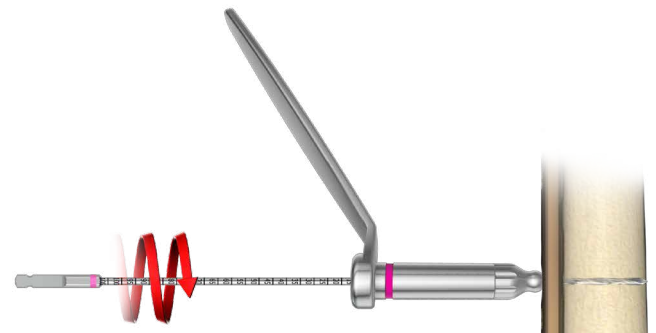

## 4c. PROCEDURE OF 5.0ChLP SELF-TAPPING SCREW 3.5 [3.5200] INSERTION

### Guide sleeve insertion

- Insert guide sleeve 5.0/2.8 [40.5673.728] into a locking hole of the plate.



### Hole drilling

Drill using drill with scale 2.8/210 [40.5653.212] until desired depth is reached.



### Measurement of hole depth

OPTION I: Read the length of the screw from the drill measure [40.5653.212]



OPTION II: or use screw length measure [40.5675.500].



OPTION III: Having removed the guide sleeve 5.0/2.8 [40.5673.728], use depth measure [40.4639.550] to determine the length of a screw.



### Screw insertion

Remove the guide sleeve 5.0/2.8 [40.5673.728]. Use torque limiting ratchet handle 2Nm [40.6652.000] and screwdriver tip T15 [40.5677.000] to insert the locking screw.



The final tightening of the locking screw, especially when a drive is used, should always be performed with the use of torque limiting handle. Failure to use the torque limiting handle may lead to intraoperative and postoperative complications (*during later removal of the plate and locking screws*).

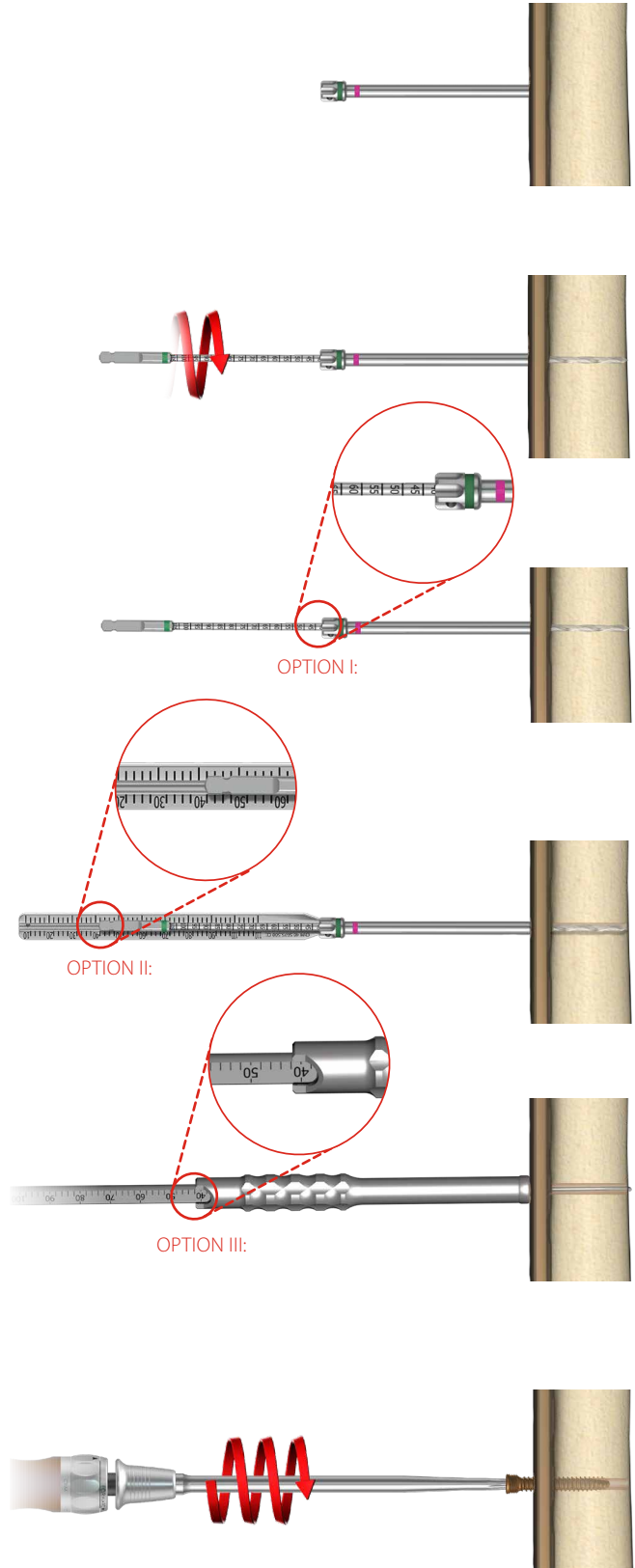

#### 4d. PROCEDURE OF 4.5ChLP SCREW 2.4 [3.5225] INSERTION

##### Guide sleeve insertion

- Insert guide sleeve 5.0/1.8 [40.5673.718] into a locking hole of the plate.



40.5673.718

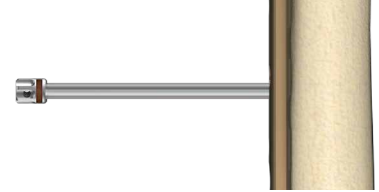

##### Hole drilling

Drill using drill with scale 1.8/210 [40.2063.222] until desired depth is reached.



40.2063.212

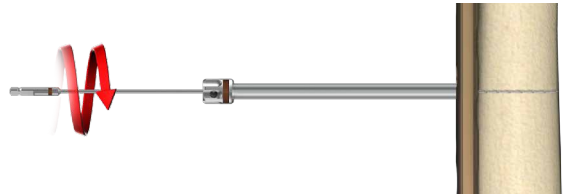

##### Measurement of hole depth

**OPTION I:** Read the length of the screw from screw length measure [40.5675.500].



40.5675.500

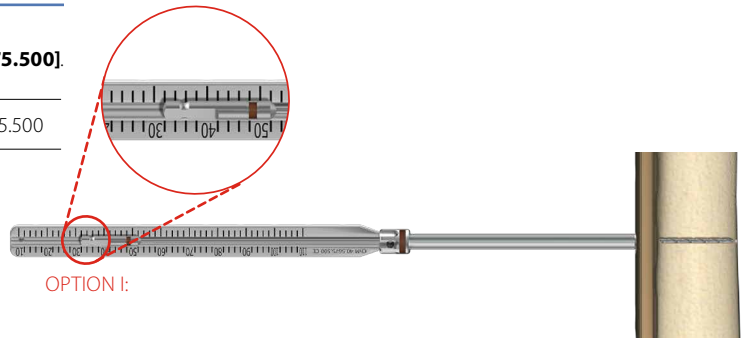

OPTION I:

**OPTION II:** Having removed the guide sleeve 5.0/1.8 [40.5673.718], use depth measure [40.4639.550] to determine the length of a screw.



40.4639.550

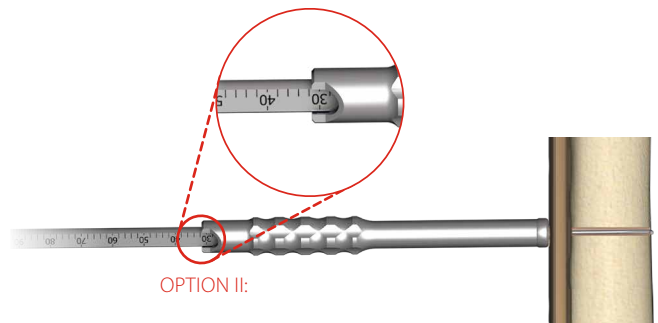

OPTION II:

##### Screw insertion

Remove the guide sleeve 5.0/1.8 [40.5673.718]. Use torque limiting ratchet handle 2Nm [40.6652.000] and screwdriver tip T15 [40.5677.000] to insert the locking screw.



40.6652.000



40.5677.000

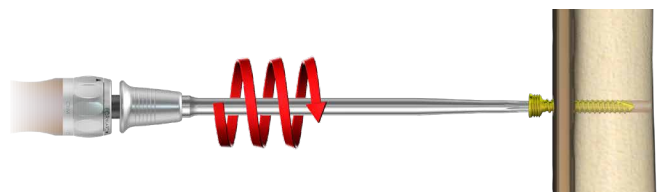



4e. PROCEDURE OF 5.0ChLP SCREW VA 3.5 [4.5236] INSERTION



When using variable angle (VA) screws, there is a risk of collision of screws or a drill with already implanted screws. Well-thought-out trajectory of inserted screws and intraoperative X-Ray control of drilling reduces the risk of the collision.

Guide VA positioning

- Insert the guide VA 2.8 [40.8206.028] into the locking hole co-axially.
- Set the desired inclination of the guide in relation to the locking hole axis. The guide enables the inclination of 15° in each direction with respect to the axis of the locking hole.



Exceeding the inclination angle of more than 15° may prevent proper locking of the VA screw in the plate hole.

Hole drilling

- Drill using drill with scale 2.8/210 [40.5653.212] until desired depth is reached.



Drill under X-Ray control to avoid a collision of the drill with already implanted screws.

Measurement of hole depth

OPTION I: Read the length of the screw from the drill measure [40.5653.212].



OPTION II: or use screw length measure [40.5675.500].



OPTION III: Having removed the guide VA, use depth measure [40.4639.550] to determine the length of the screw.

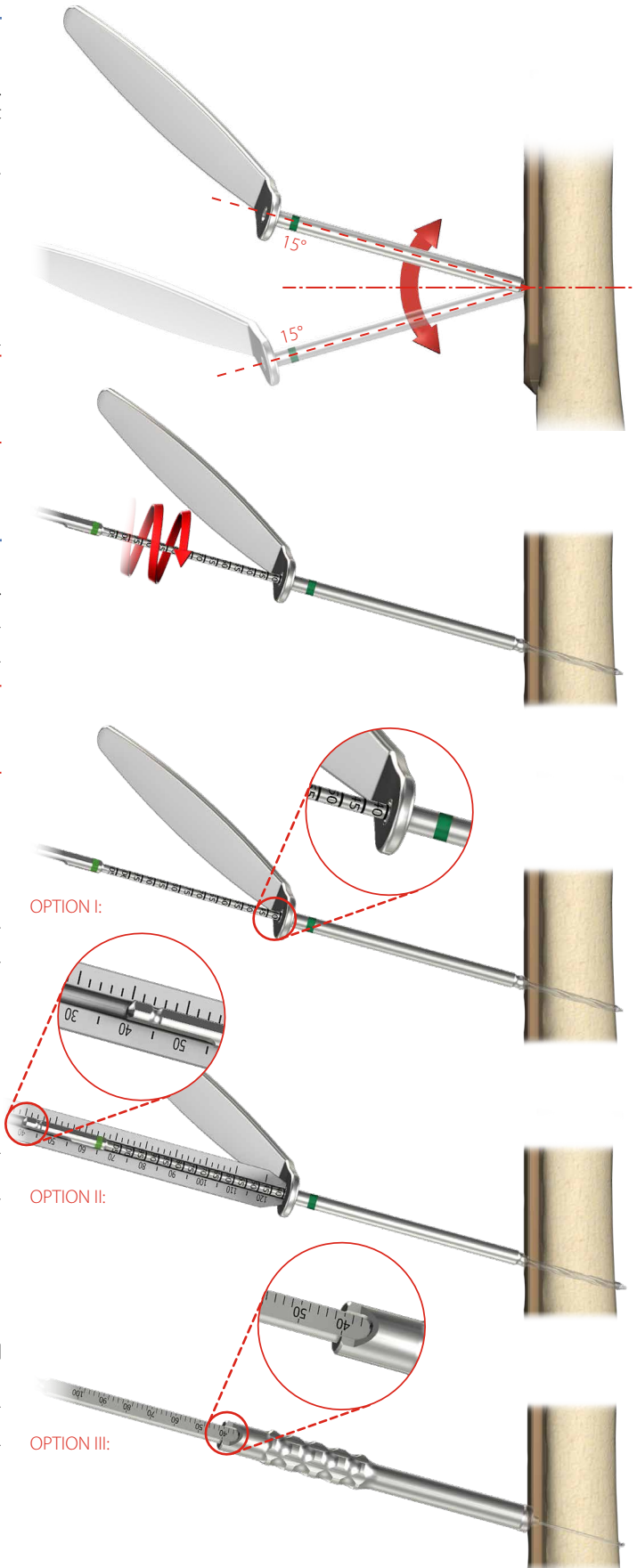

## Screw insertion

Use torque limiting ratchet handle 2Nm **[40.6652.000]** and screwdriver tip T15 **[40.5677.000]** to insert the VA screw.

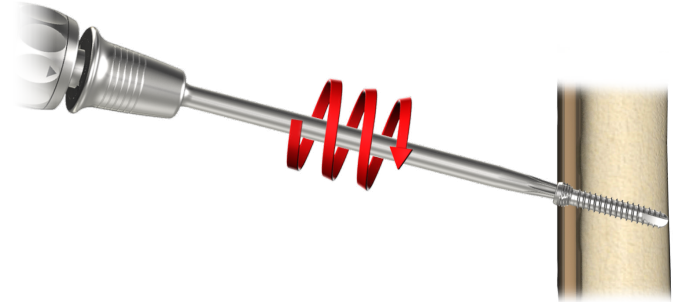

When using torque limiting handle to tighten the VA screw with large inclination in relation to the axis of the locking hole, the head of the screw may protrude above the plate. In this case, it may be necessary to use a handle ratchet device **[40.6654]** and screwdriver tip T15 **[40.5677]**. Use the instruments carefully to tighten the VA screw. Avoid damaging the screw socket or screwdriver tip. Do not insert the screw too deep into the plate.

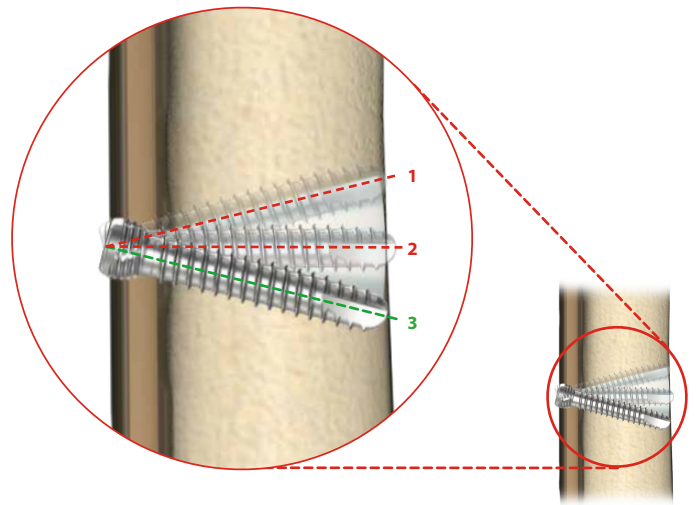

### Change of the VA screw positioning



It is possible to lock the VA screw three times in the threaded hole of the plate. The hole in the plate in which the VA screw was locked cannot be used to insert a standard locking screw.

## 5. POSTOPERATIVE PROCEDURE

Introduce appropriate post-operative treatment. The physician decides on the post-operative treatment and its conduct. In order to avoid patient's movement limitations, introduce exercises as soon after surgery as possible. However, make sure that the limb is not fully loaded before fragments osteosynthesis is complete.

## 6. IMPLANT REMOVAL

The physician decides about implant removal. In order to remove the implants from the body, unlock all the locking screws first and then remove them from the bone. This will prevent any rotation of the plate when removing the last locking screw.













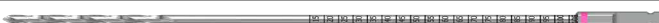
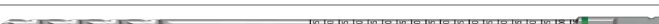

Having cleaned the outer surface of the plate and the screws sockets, it is recommended to attach the aiming block to the plate. Using aiming block and protective sleeve ensures positioning of the screwdriver tip in the axis of the screw, its full placement in the recess, and reduces the risk of twisting the screw while removing.





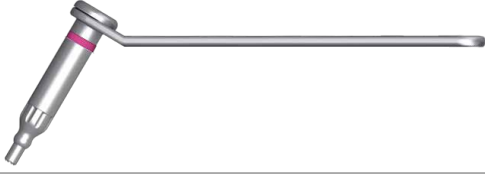



## 7. CATALOGUE PAGES

## 7a. INSTRUMENT SET

Instrument set for 5.0ChLP 4x4 1/2H

15.0205.206

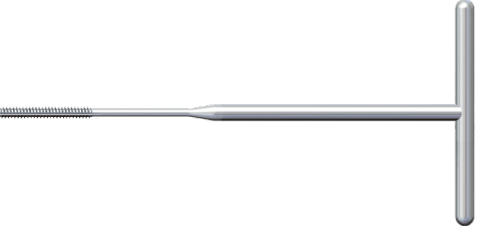
	Name	Catalogue No.	Pcs
	Tray for 5.0ChLP instrument set 4x4 1/2H	14.0205.206	1
	Kirschner wire 1.5/210	40.4592.210	4
	Drill 1.8/210	40.2063.212	2
	Drill with scale 2.5/210	40.5912.212	2
	Drill with scale 2.8/210	40.5653.212	2
	Screwdriver tip T15	40.5677.000	1
	Torque limiting ratchet handle 2Nm	40.6652.000	1
	Handle ratchet device	40.6654.000	1
	Protective guide 7/5	40.5672.000	2
	Guide VA 2.8	40.8206.028	1
	Compression guide 2.5	40.4804.725	1
	Guide sleeve 5.0/1.8	40.5673.718	2
	Guide sleeve 5.0/2.8	40.5673.728	4
	Depth measure	40.4639.550	1

	Name	Catalogue No.	Pcs
	Tray for 5.0ChLP instrument set 4x4 1/2H	14.0205.202	1
	Setting-compressing screw 2.8/180	40.5674.728	1
	Screw length measure	40.5675.500	1
	Plates bender 5.0	40.4643.500	2
	Tripod screwdriver tip 5.0ChLP	40.6271.500	1
	T15 screwdriver tip with holder	40.6254.000	1
	Cortical tap HA 3.5 with handle	40.2548.200	1
	Tap 5.0ChLP-3.5	40.5661.000	1
<b>Optional instrument</b>			
	Torque connector 2Nm	40.5927.020	1



5.0ChLP distal lateral humerus plate

	Len	L	R
4	91	3.7037.604	3.7036.604
6	111	3.7037.606	3.7036.606
8	131	3.7037.608	3.7036.608
10	151	3.7037.610	3.7036.610
12	171	3.7037.612	3.7036.612

O - holes number in shaft part of the plate

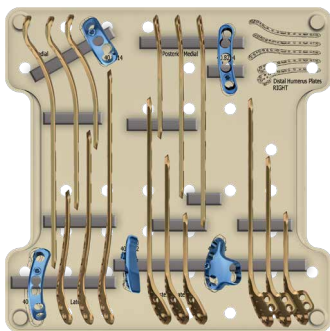
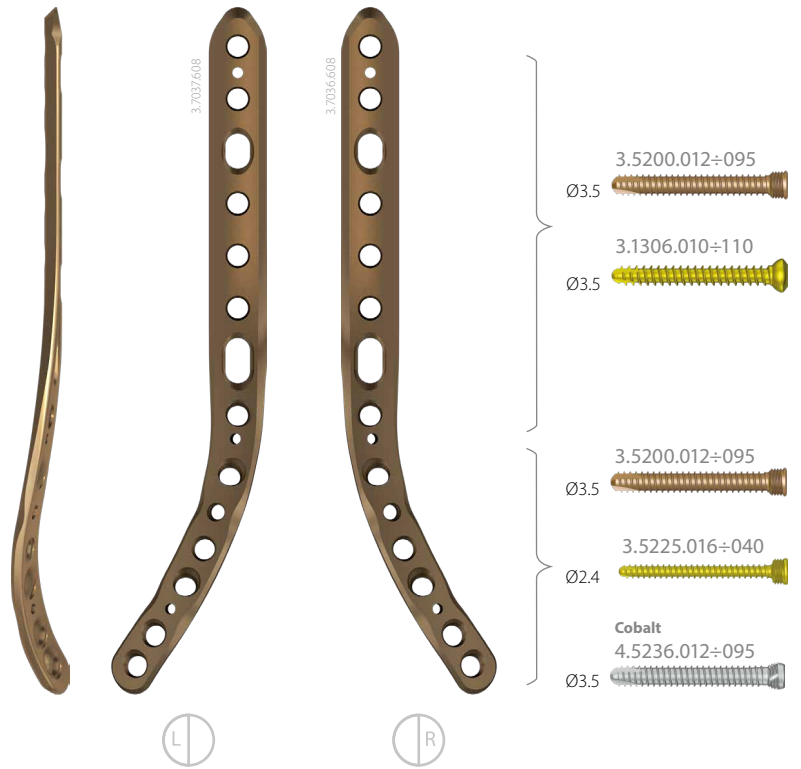

Tray for plates 5.0ChLP 4x4 1/2H (3.7036, 3.7038, 3.7040, 3.7072, 3.7074) 14.0205.420

Tray for plates 5.0ChLP 4x4 1/2H (3.7037, 3.7039, 3.7041, 3.7073, 3.7075) 14.0205.419



Aiming block R (3.7036) 40.8210.000



Aiming block L (3.7037) 40.8211.000

Plate 3.7036.606 trial 43.7036.606

Plate 3.7037.606 trial 43.7037.606



5.0ChLP distal posterior lateral humerus plate

	Len	L	R
4	75	3.7039.604	3.7038.604
6	94	3.7039.606	3.7038.606
8	113	3.7039.608	3.7038.608
10	131	3.7039.610	3.7038.610
12	150	3.7039.612	3.7038.612

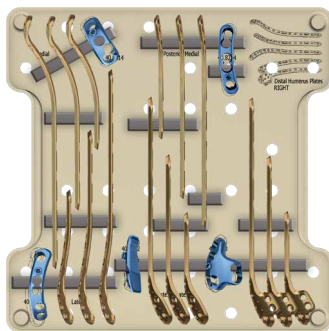
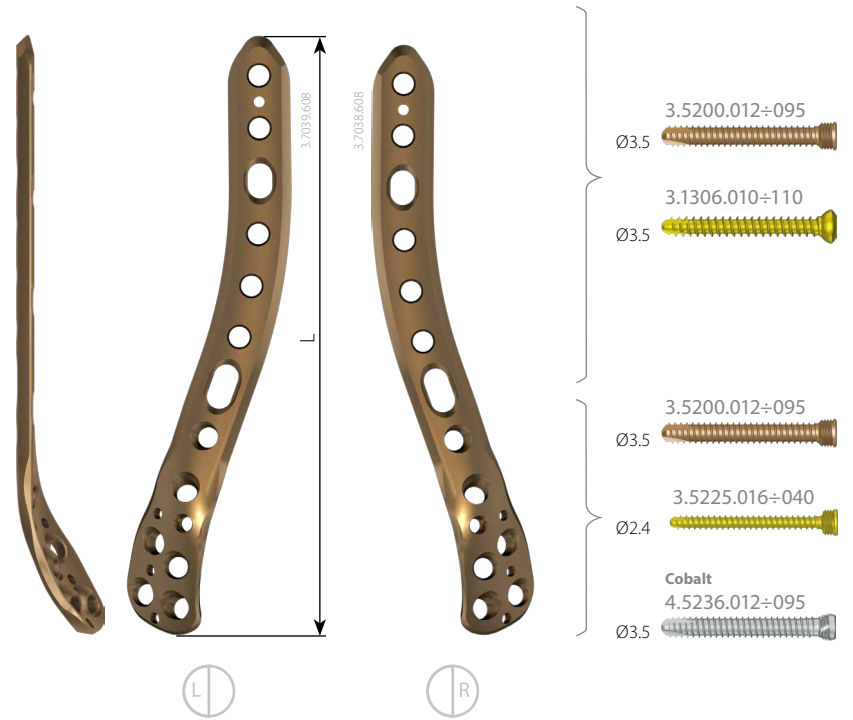

Tray for plates 5.0ChLP 4x4 1/2H (3.7036, 3.7038, 3.7040, 3.7072, 3.7074)	14.0205.420	Aiming block R (3.7038)	40.8212.000	Plate 3.7038.606 trial	43.7038.606
Tray for plates 5.0ChLP 4x4 1/2H (3.7037, 3.7039, 3.7041, 3.7073, 3.7075)	14.0205.419	Aiming block L (3.7037)	40.8213.000	Plate 3.7039.606 trial	43.7039.606



5.0ChLP distal posterior medial humerus plate

	Len	L	R
4	84	3.7040.604	3.7041.604
6	104	3.7040.606	3.7041.606
8	124	3.7040.608	3.7041.608
10	144	3.7040.610	3.7041.610
12	164	3.7040.612	3.7041.612

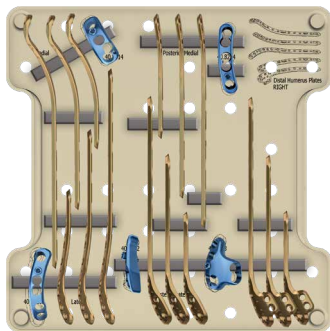
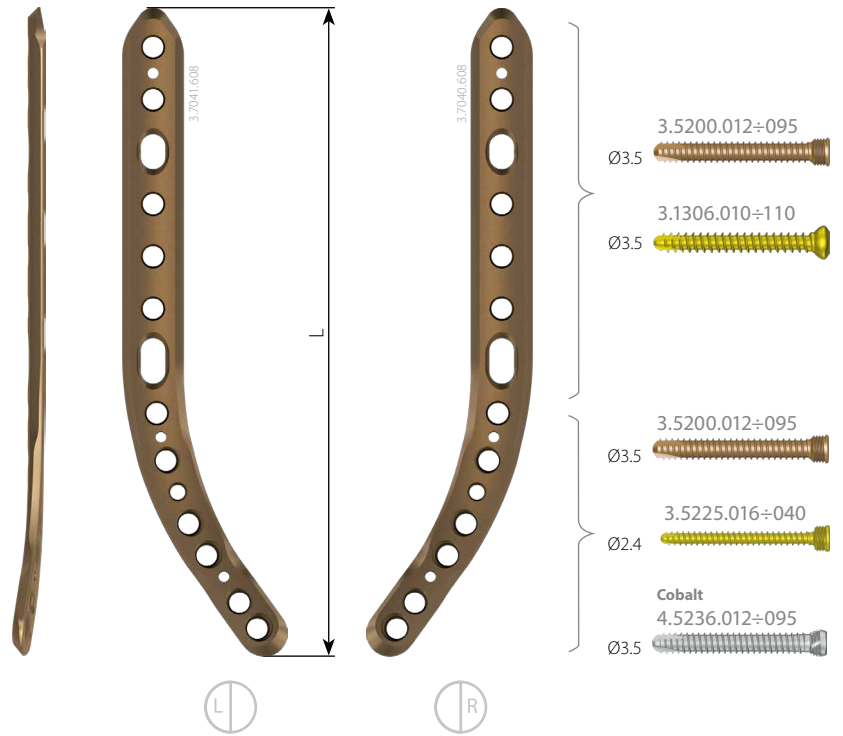

Tray for plates 5.0ChLP 4x4 1/2H (3.7036, 3.7038, 3.7040, 3.7072, 3.7074) 14.0205.420

Tray for plates 5.0ChLP 4x4 1/2H (3.7037, 3.7039, 3.7041, 3.7073, 3.7075) 14.0205.419

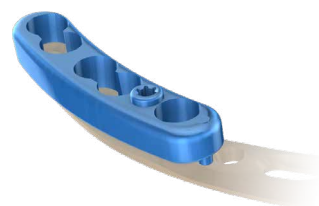

Aiming block R (3.7040) 40.8214.000

Aiming block L (3.7041) 40.8215.000

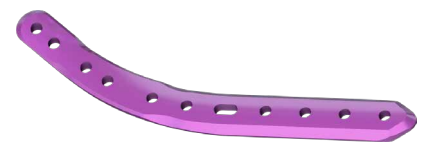

Plate 3.7040.606 trial 43.7040.606

Plate 3.7041.606 trial 43.7041.606





5.0ChLP distal medial humerus plate

	Len	L	R
4	91	3.7071.604	3.7072.604
6	111	3.7071.606	3.7072.606
8	131	3.7071.608	3.7072.608
10	151	3.7071.610	3.7072.610
12	170	3.7071.612	3.7072.612

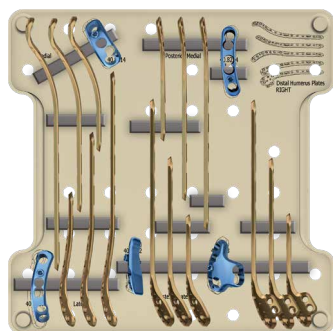
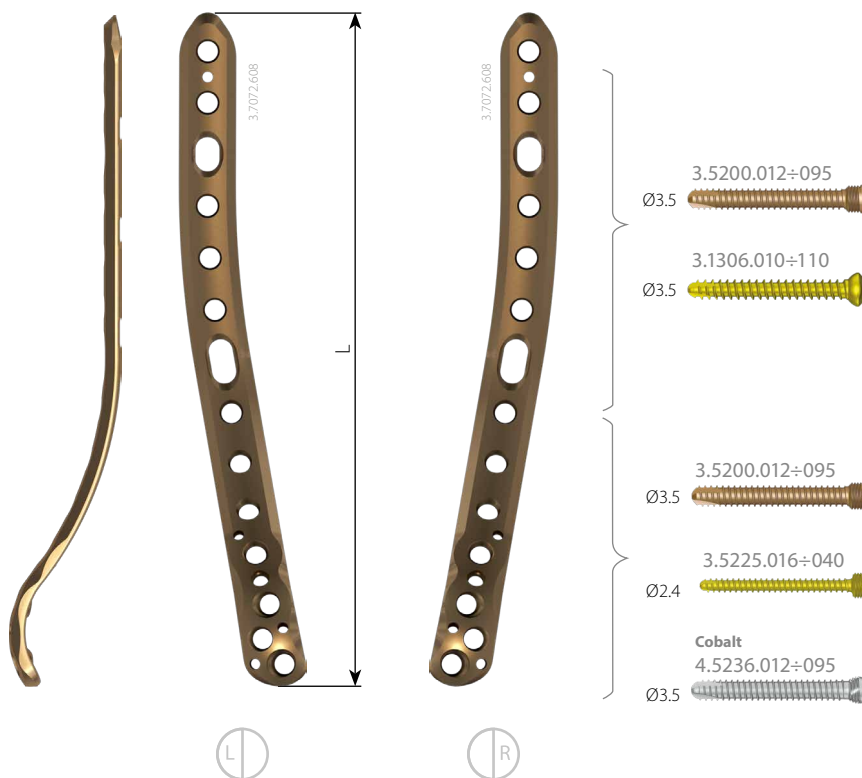

Tray for plates 5.0ChLP 4x4 1/2H (3.7036, 3.7038, 3.7040, 3.7072, 3.7074) 14.0205.420

Tray for plates 5.0ChLP 4x4 1/2H (3.7037, 3.7039, 3.7041, 3.7073, 3.7075) 14.0205.419



Aiming block L (3.7071) 40.8217.000

Aiming block R (3.7072) 40.8216.000



Plate 3.7071.606 trial 43.7071.606

Plate 3.7072.606 trial 43.7072.606



5.0ChLP distal dorsolateral humerus plate

	Len	L	R
4	75	3.7073.604	3.7074.604
6	94	3.7073.606	3.7074.606
8	113	3.7073.608	3.7074.608
10	132	3.7073.610	3.7074.610
12	151	3.7073.612	3.7074.612

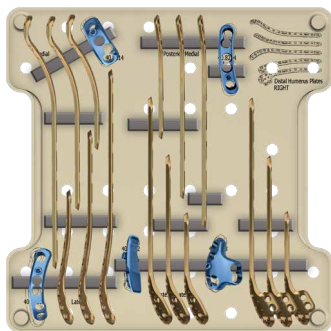
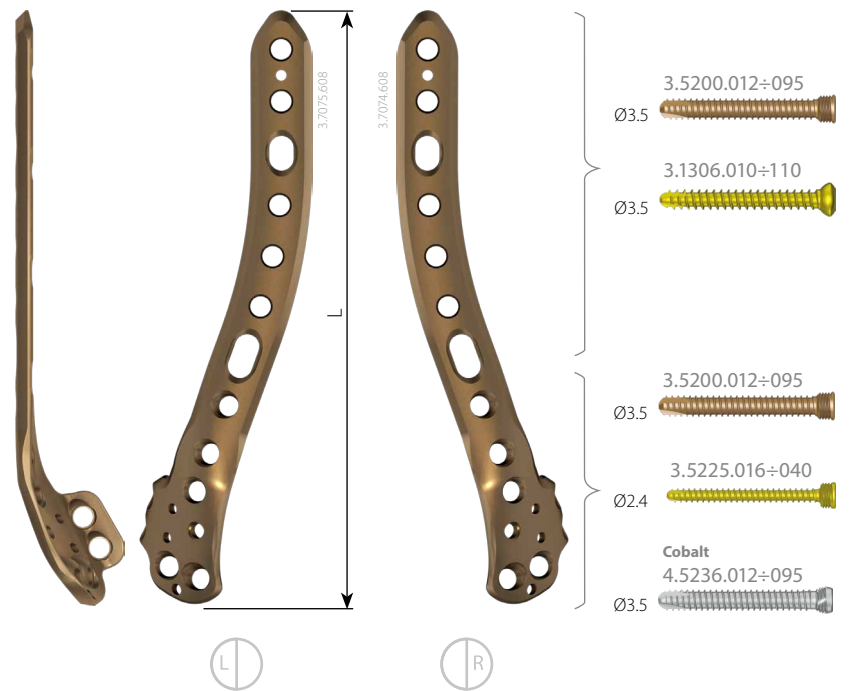

Tray for plates 5.0ChLP 4x4 1/2H (3.7036, 3.7038, 3.7040, 3.7072, 3.7074)	14.0205.420
Tray for plates 5.0ChLP 4x4 1/2H (3.7037, 3.7039, 3.7041, 3.7073, 3.7075)	14.0205.419

Aiming block L (3.7073)	40.8219.000
Aiming block R (3.7074)	40.8218.000

Plate 3.7002.504 trial	43.7073.606
Plate 3.7003.504 trial	43.7074.606

## 7c. SCREWS

## 5.0ChLP self-tapping screw 3.5



Len	TiA
12	3.5200.012
14	3.5200.014
16	3.5200.016
18	3.5200.018
20	3.5200.020
22	3.5200.022
24	3.5200.024
26	3.5200.026
28	3.5200.028
30	3.5200.030
32	3.5200.032
34	3.5200.034
36	3.5200.036
38	3.5200.038
40	3.5200.040
42	3.5200.042
44	3.5200.044
46	3.5200.046
48	3.5200.048
50	3.5200.050
52	3.5200.052
54	3.5200.054
56	3.5200.056
58	3.5200.058
60	3.5200.060
65	3.5200.065
70	3.5200.070
75	3.5200.075
80	3.5200.080
85	3.5200.085

## 5.0ChLP screw VA 3.5



Len	Co
12	4.5236.012
14	4.5236.014
16	4.5236.016
18	4.5236.018
20	4.5236.020
22	4.5236.022
24	4.5236.024
26	4.5236.026
28	4.5236.028
30	4.5236.030
32	4.5236.032
34	4.5236.034
36	4.5236.036
38	4.5236.038
40	4.5236.040
42	4.5236.042
44	4.5236.044
46	4.5236.046
48	4.5236.048
50	4.5236.050
52	4.5236.052
54	4.5236.054
56	4.5236.056
58	4.5236.058
60	4.5236.060
65	4.5236.065
70	4.5236.070
75	4.5236.075
80	4.5236.080
85	4.5236.085
90	4.5236.090
95	4.5236.095

## Cortical self-tapping screw 3.5



Len	Ti
10	3.1306.010
12	3.1306.012
14	3.1306.014
16	3.1306.016
18	3.1306.018
20	3.1306.020
22	3.1306.022
24	3.1306.024
26	3.1306.026
28	3.1306.028
30	3.1306.030
32	3.1306.032
34	3.1306.034
36	3.1306.036
38	3.1306.038
40	3.1306.040
45	3.1306.045
50	3.1306.050
55	3.1306.055
60	3.1306.060
65	3.1306.065
70	3.1306.070
75	3.1306.075
80	3.1306.080
85	3.1306.085

## 4.5ChLP screw 2.4



Len	Ti
16	3.5225.016
18	3.5225.018
20	3.5225.020
22	3.5225.022
24	3.5225.024
26	3.5225.026
28	3.5225.028
30	3.5225.030
32	3.5225.032
34	3.5225.034
36	3.5225.036
38	3.5225.038
40	3.5225.040

**ChM sp. z o.o.**

Lewickie 3b  
16-061 Juchnowiec Kościelny  
Polska  
tel. +48 85 86 86 100  
fax +48 85 86 86 101  
chm@chm.eu  
www.chm.eu



CE 0197