

# CHM<sup>®</sup>

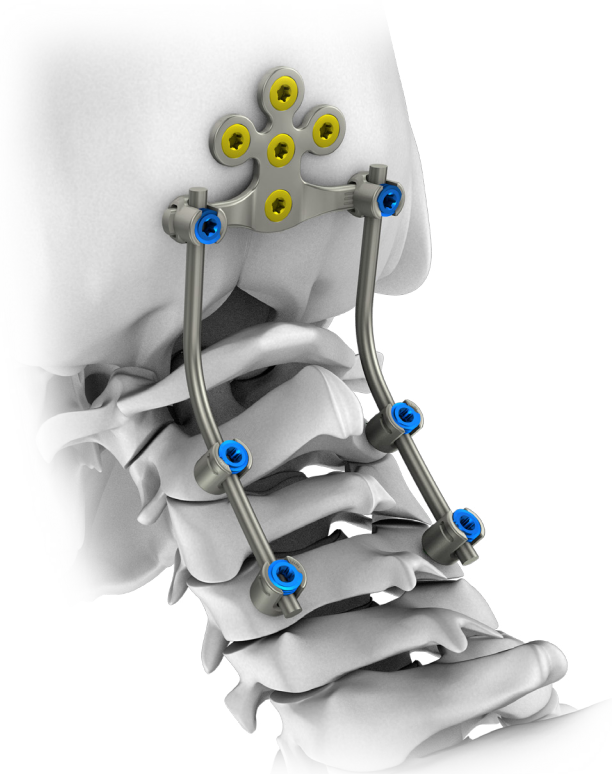





**CHARSPINE** *system* **OCT**  
Occipito-Cervico-Thoracic Stabilization System

## CHARSPINE OCT - system for occipito-cervico-thoracic spine stabilization

- *IMPLANTS*
- *INSTRUMENT SET*
- *SURGICAL TECHNIQUE*



## SYMBOLS DESCRIPTION

	Caution - pay attention to a special procedure.
	Perform the activity under X-Ray control.
	Information about the next stages of a procedure.
	Proceed to the next stage.
	Return to the specified stage and repeat the activity.
	Before using the product, carefully read the Instructions for Use. It contains, among others, indications, contraindications, side effects, recommendations and warnings related to the use of the product.
	The above description is not a detailed instruction of conduct. The surgeon decides about choosing the operating procedure.

**[www.chm.eu](http://www.chm.eu)**

Document No            ST/87B  
Date of issue            14.02.2020  
Review date            P-005-07.12.2020

*The manufacturer reserves the right to introduce design changes.*

*Updated INSTRUCTIONS FOR USE are available at the following website: [ifu.chm.eu](http://ifu.chm.eu)*

1. INTRODUCTION	5
2. INDICATIONS	5
3. CONTRAINDICATIONS	5
4. SYSTEM DESCRIPTION	6
4.1. IMPLANTS	7
4.2. INSTRUMENTS	14
5. SURGICAL TECHNIQUE	18
5.1. PATIENT POSITIONING AND SURGICAL APPROACH	18
5.2. OCT SCREWS INSERTION	18
5.3. HOOK INSERTION	22
5.4. RODS	23
5.5. ARTICULATED CONNECTORS	29
5.6. LATERAL CONNECTORS	31
5.7. AXIAL AND PARALLEL CONNECTORS	31
5.8. STABILIZATION USING OCCIPITAL PLATE [3.6107]	32
5.9. STABILIZATION USING BILATERAL OCCIPITAL PLATE [3.5995]	37



## 1. INTRODUCTION

The **CHARSPINE OCT** system was developed for the treatment of diseases and injuries of the occipito-cervico-thoracic spine through stabilization of the operated segment.

The stabilization is performed through posterior approach, with use of specialized instruments and a number of implants included in the system, such as: rods, screws, hooks, occipital plates and various types of connectors.

## 2. INDICATIONS

Instability in the upper cervical spine and cervical-occipital junction which may be caused by:

- rheumatoid arthritis,
- congenital anomalies,
- post-traumatic conditions,
- tumors,
- infections

Instability in the lower cervical spine and upper thoracic spine, which may be caused, e.g., by:

- post-traumatic conditions,
- tumors,
- iatrogenic instabilities after laminectomy, etc.

Degenerative diseases and painful post-traumatic conditions in the lower cervical and upper thoracic spine.

## 3. CONTRAINDICATIONS

- Extensive spine instability caused by damage to the vertebral bodies (*as a result of tumors, fractures, infections*). In such cases, stabilization with **CHARSPINE OCT** system is only possible when supported by an additional anterior stabilization.
- Advanced osteoporosis.

## 4. SYSTEM DESCRIPTION

- small diameter and low profile of the screw head and occipital plate connectors,
- wide range of rod spacing on the occipital plate,
- contourable occipital plates,
- two types of occipital plates,
- multiangular positioning of the occipital screws in occipital plates,

- the undercut thread profile of the locking screw prevents the arms of the polyaxial screw head from parting,
- the screw offers 90° angulation,
- tulip heads in the occipital plate offer 20° angulation in the plane of the plate,
- locking screws tightened up with a 3.3Nm torque wrench,
- the same locking screw for polyaxial screws, hooks and occipital plate,
- V-groove shape of the tulip socket for optimal three-point locking of the rod,

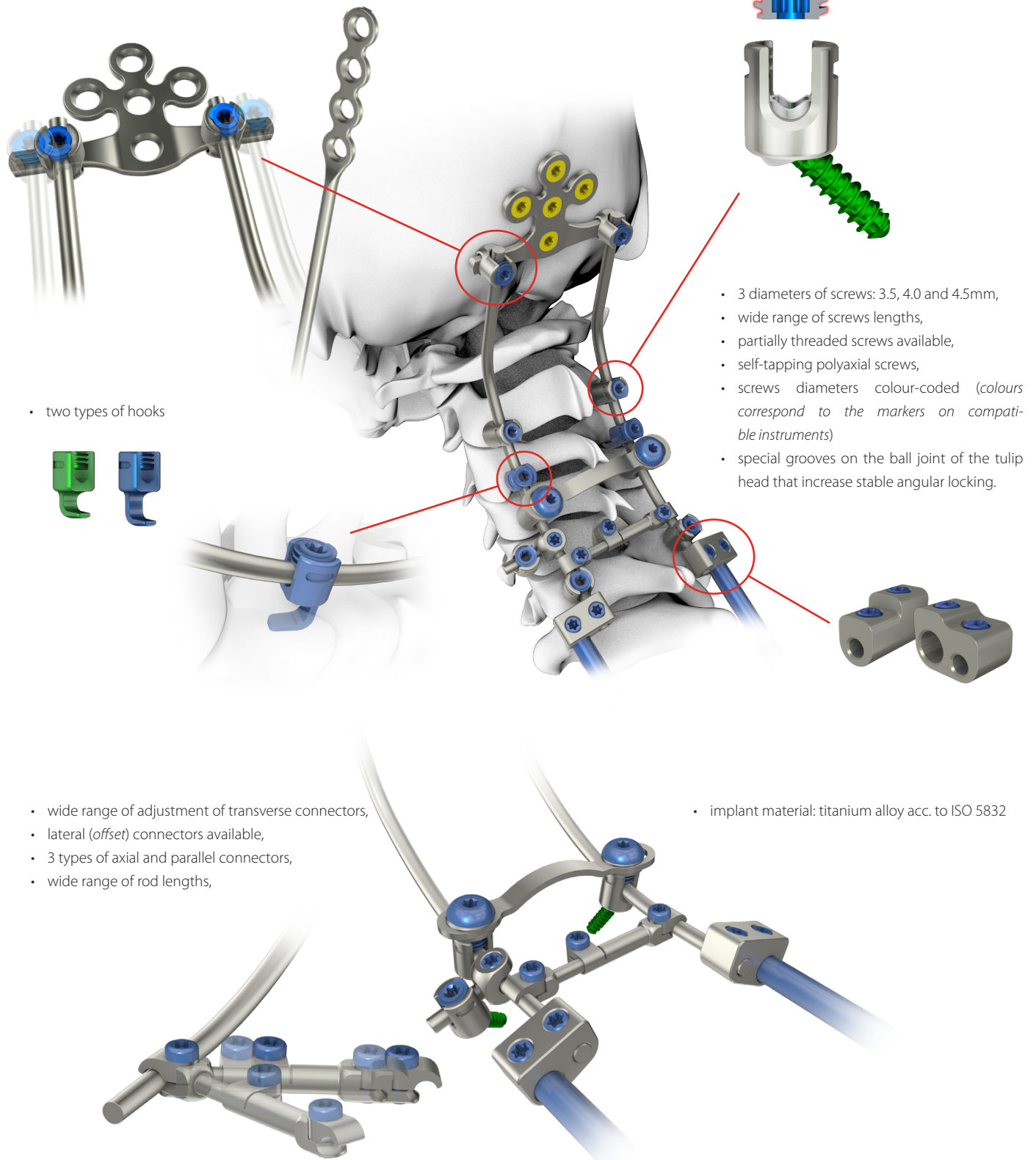

- two types of hooks

- 3 diameters of screws: 3.5, 4.0 and 4.5mm,
- wide range of screws lengths,
- partially threaded screws available,
- self-tapping polyaxial screws,
- screws diameters colour-coded (colours correspond to the markers on compatible instruments)
- special grooves on the ball joint of the tulip head that increase stable angular locking.

- wide range of adjustment of transverse connectors,
- lateral (*offset*) connectors available,
- 3 types of axial and parallel connectors,
- wide range of rod lengths,

- implant material: titanium alloy acc. to ISO 5832

4.1. IMPLANTS

CHARSPINE OCT POLYAXIAL SCREWS

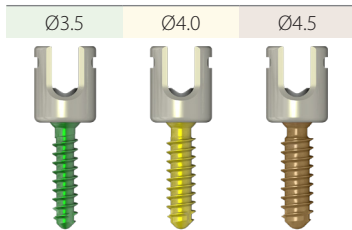
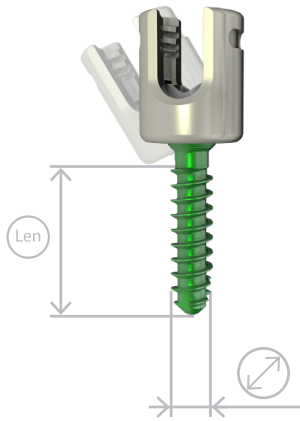





Ø [mm]	Len [mm]	Ti
3.5	10	3.5999.010
	12	3.5999.012
	14	3.5999.014
	16	3.5999.016
	18	3.5999.018
	20	3.5999.020
	22	3.5999.022
	24	3.5999.024
	26	3.5999.026
	28	3.5999.028
	30	3.5999.030
	32	3.5999.032
	34	3.5999.034
	4.0	10
12		3.6100.012
14		3.6100.014
16		3.6100.016
18		3.6100.018
20		3.6100.020
22		3.6100.022
24		3.6100.024
26		3.6100.026
28		3.6100.028
30		3.6100.030
32		3.6100.032
34		3.6100.034
36		3.6100.036
38	3.6100.038	
40	3.6100.040	
4.5	10	3.6101.010
	12	3.6101.012
	14	3.6101.014
	16	3.6101.016
	18	3.6101.018
	20	3.6101.020
	22	3.6101.022
	24	3.6101.024
	26	3.6101.026
	28	3.6101.028
	30	3.6101.030
	32	3.6101.032
	34	3.6101.034
	36	3.6101.036
38	3.6101.038	
40	3.6101.040	

CHARSPINE OCT LOCKING SCREW

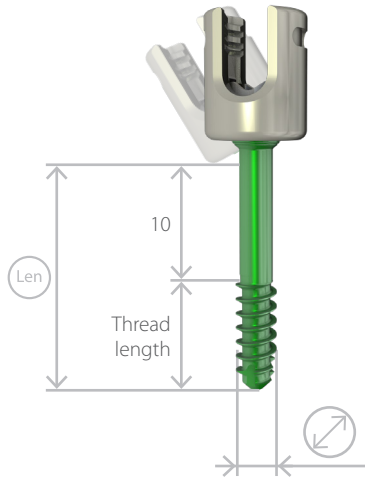

CHARSPINE OCT POLYAXIAL SCREWS PARTIALLY THREADED



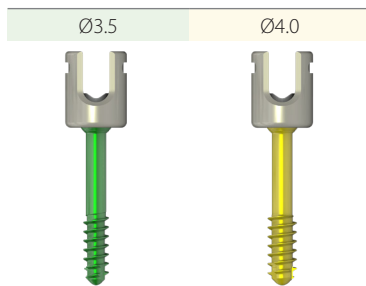

 [mm]	 [mm]	Thread length [mm]	
3.5	24	14	3.5998.024
	26	16	3.5998.026
	28	18	3.5998.028
	30	20	3.5998.030
	32	22	3.5998.032
	34	24	3.5998.034
4.0	36	26	3.5998.036
	24	14	3.5997.024
	26	16	3.5997.026
	28	18	3.5997.028
	30	20	3.5997.030
	32	22	3.5997.032
	34	24	3.5997.034
	36	26	3.5997.036



CHARSPINE OCT LOCKING SCREW



	
3.6111.000	✓



## CHARSPINE OCT ARTICULATED CONNECTORS (HEAD TO HEAD)

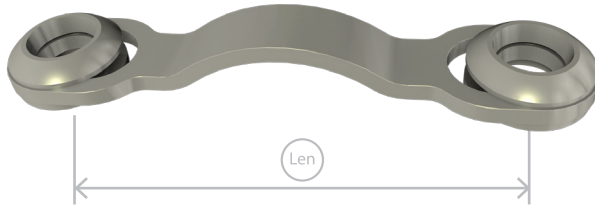

Len [mm]	Ti
29÷35	3.5996.035
34÷40	3.5996.040
39÷45	3.5996.045
44÷50	3.5996.050
49÷55	3.5996.055

## CHARSPINE OCT LOCKING SCREWS - CONNECTOR

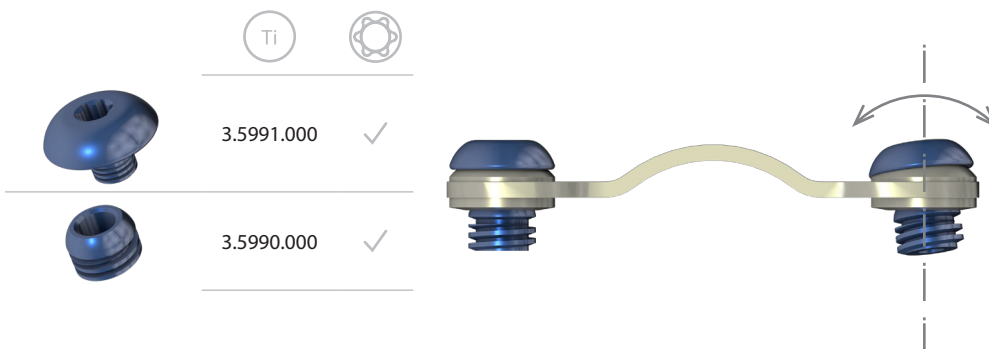

Ti	
3.5991.000	✓
3.5990.000	✓

## CHARSPINE OCT ARTICULATED CONNECTORS (ROD TO ROD)

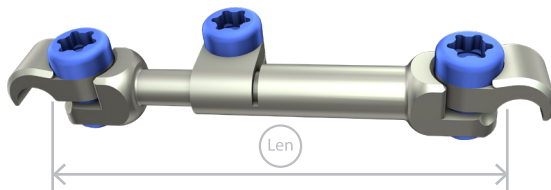

Len [mm]	Ti
29÷34	3.6104.034
33÷42	3.6104.042
40÷55	3.6104.055

## CHARSPINE OCT LATERAL CONNECTORS

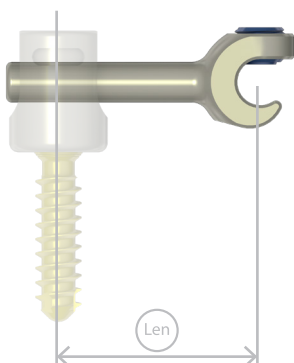

Len [mm]	Ti
9÷12	3.6103.012
9÷20	3.6103.020

CHARSPINE OCT CERVICAL LAMINAR HOOK

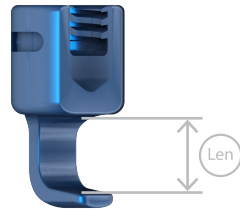

Len [mm]	Ti
4.5	3.6102.001
6	3.6102.002

CHARSPINE OCT LOCKING SCREW

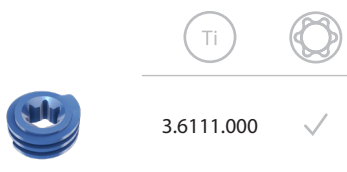

Ti	✓
3.6111.000	✓

CHARSPINE OCT AXIAL CONNECTORS

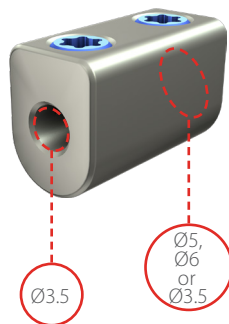

[mm]	Ti
6/3.5	3.3970.863
5/3.5	3.3970.853
3.5/3.5	3.3970.833

CHARSPINE OCT PARALLEL CONNECTORS

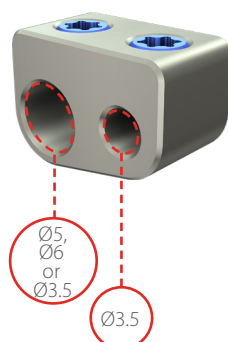

[mm]	Ti
6/3.5	3.3970.963
5/3.5	3.3970.953
3,5/3,5	3.3970.933

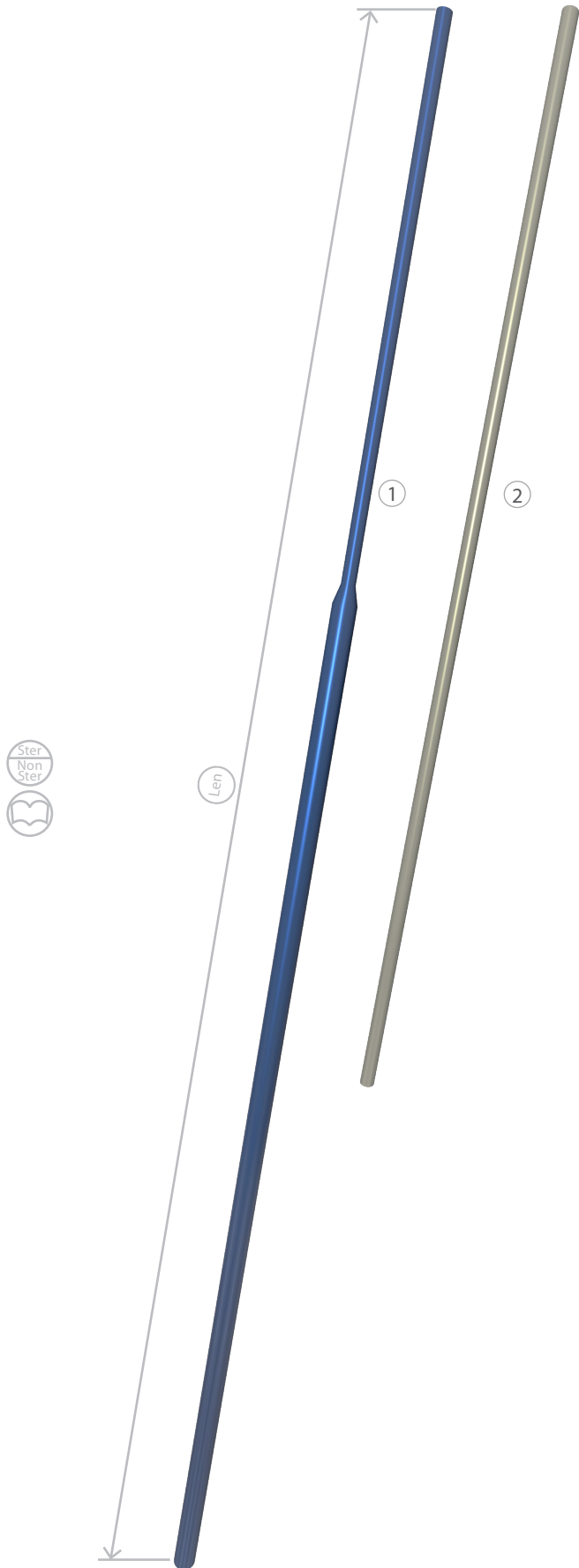

### CHARSPINE OCT ROD Ø3.5/6.0

	Len [mm]	Ti
①	400	3.6106.400

### CHARSPINE OCT ROD Ø3.5

	Len [mm]	Ti
	40	3.6105.040
	60	3.6105.060
②	90	3.6105.090
	150	3.6105.150
	240	3.6105.240

CHARSPINE OCT OCCIPITAL PLATES

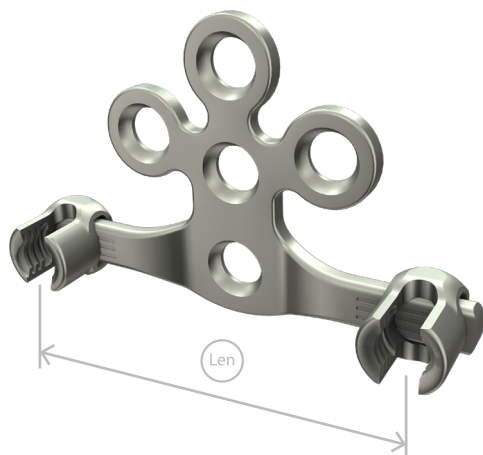

Len [mm]	Ti
small (25÷35)	3.6107.035
medium (35÷45)	3.6107.045
large (45÷55)	3.6107.055

CHARSPINE OCT LOCKING SCREW

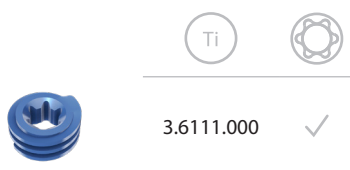

Ti	Image
3.6111.000	✓



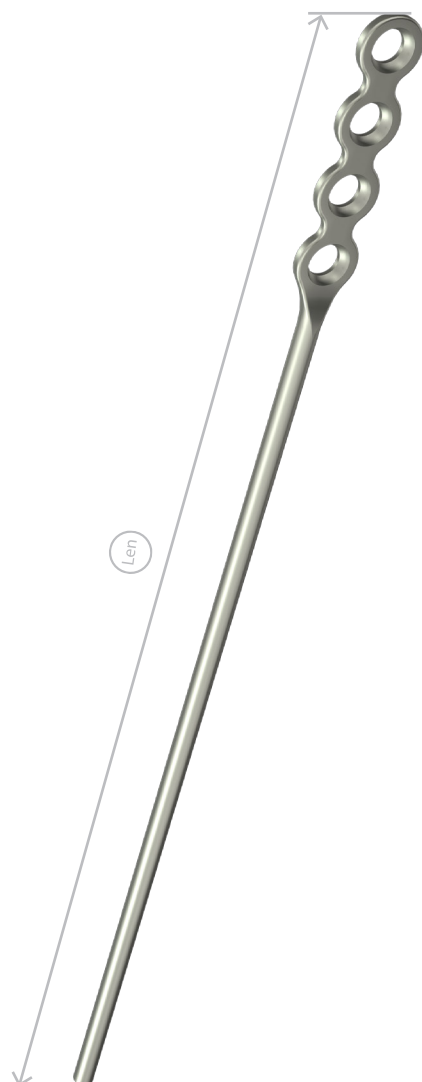

CHARSPINE OCT BILATERAL OCCIPITAL PLATE

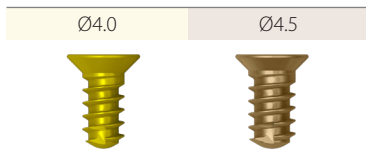
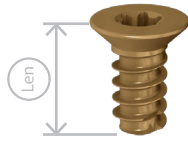

Len [mm]	Ti
200	3.5995.204

## CHARSPINE OCT OCCIPITAL SCREWS



				
	[mm]	[mm]		
4.0		6	3.6109.006	
		8	3.6109.008	
		10	3.6109.010	
		12	3.6109.012	
		14	3.6109.014	
		16	3.6109.016	
4.5		6	3.6110.006	
		8	3.6110.008	
		10	3.6110.010	
		12	3.6110.012	
		14	3.6110.014	
		16	3.6110.016	

40.8346.000  
 Palette for CHARSPINE OCT implants

Name



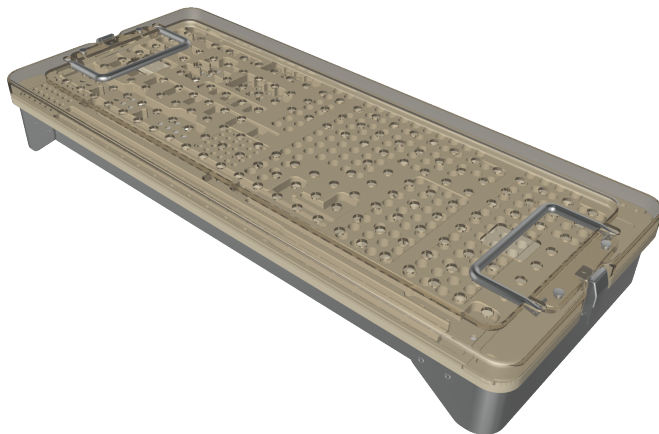



Catalogue no.



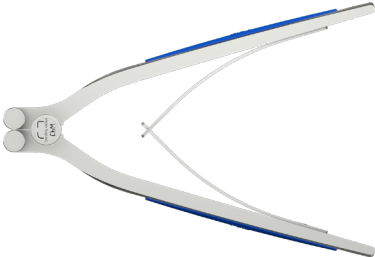
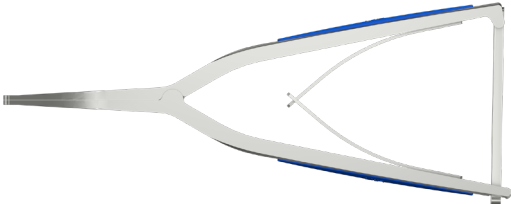
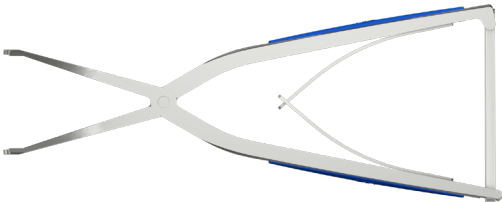

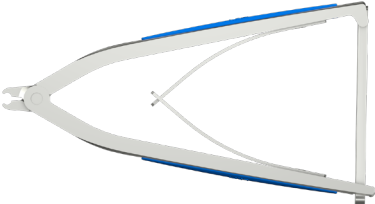
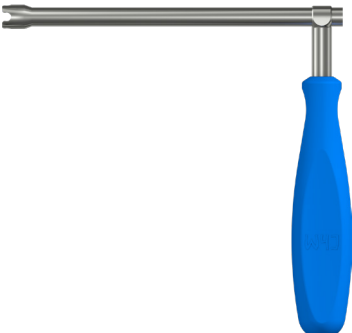













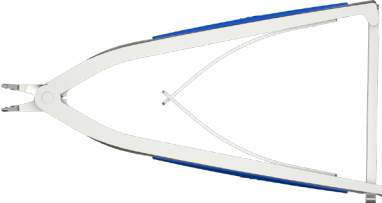

Palette for CHARSPINE OCT implants

40.8346.000

## 4.2. INSTRUMENTS

CHARSPINE OCT Instrument set - basic		15.0915.101
	Name	Catalogue no. Pcs
	<b>Adjustable rod bender</b> The bender is used to profile the rod.	40.5770.000 1
	<b>Distraction forceps</b> The forceps are used for vertebral distraction.	40.5771.000 1
	<b>Compression forceps</b> The forceps are used for vertebral compression.	40.5772.000 1
	<b>Adjustable guide sleeve</b> The sleeve is used for regulated insertion of drills into pedicles.	40.5773.000 1
	<b>Forceps</b> The forceps are intended for holding and insertion of a spinal rod.	40.5774.000 1
	<b>Counter wrench</b> The wrench is used to ensure the rotational stability of the implants system when tightening the locking screws up.	40.5775.000 1
	<b>Screw persuader</b> The persuader can be used to push the rod to the bottom of the tulip head in the pedicle screw.	40.5776.000 1
	<b>Drill with limiter 2.4</b> The drill is used to make a hole in the pedicle for the 3.5mm screw.	40.5777.024 1
	<b>Drill with limiter 2.9</b> The drill is used to make a hole in the pedicle for the 4.0mm screw.	40.5777.029 1

CHARSPINE OCT Instrument set - basic		15.0915.101
	Name	Catalogue no. Pcs
	<b>Drill with limiter 3.4</b> The drill is used to make a hole in the pedicle for the 4.5mm screw.	40.5777.034 1
	<b>Tap 3.5mm</b> The tap is used for tapping a hole drilled in the pedicle for the 3.5mm screw.	40.5778.035 1
	<b>Tap 4.0mm</b> The tap is used for tapping a hole drilled in the pedicle for the 4.0mm screw.	40.5778.040 1
	<b>Tap 4.5mm</b> The tap is used for tapping a hole drilled in the pedicle for the 4.5mm screw.	40.5778.045 1
	<b>Pedicle probe</b> The probe is used to check the continuity of the walls of the pedicle.	40.5779.000 1
	<b>Rod bender 3.5 left</b> The bender is used for shaping the 3.5mm rod ( <i>also in-situ</i> ).	40.5780.000 1
	<b>Rod bender 3.5 right</b> The bender is used for shaping the 3.5mm rod ( <i>also in-situ</i> ).	40.5781.000 1
	<b>Raspatory for hooks</b> The raspatory is used to prepare the room for the hook.	40.5782.000 1
	<b>Screwdriver T15</b> The screwdriver is used for insertion and initial tightening of locking screws.	40.5783.000 1
	<b>Polyaxial screws holder</b> The holder is used to manipulate the screw tulip head after insertion of the screw into the pedicle.	40.5786.000 1
	<b>Hook holder</b> The holder is intended for the implantation of spinal hooks.	40.5787.000 1
	<b>Hand hold rod cutter</b> The cutter is used to trim the 3.5mm rod.	40.5788.000 1
	<b>Screwdriver tip T15</b> The tip should be used with the torque handle 3.3Nm [40.6655.233] for final tightening of screws, hooks and lateral connectors.	40.5789.000 1
	<b>Protective guide</b> The guide is used to protect the surrounding tissues during tapping the pedicles. Additionally, it is used to measure the depth of tapping.	40.5790.000 1
	<b>Wrench for screw</b> The wrench is used with the handle ratchet device for implantation of <b>CHARSPINE OCT</b> screws.	40.5791.000 1
	<b>Trocar</b> The trocar is used to penetrate the pedicle and mark the entry point for the transpedicular screw.	40.6099.000 1
	<b>Torque handle 3.3Nm (AO)</b> The handle is used with the screwdriver tip T15 [40.5789.000] for final tightening of locking screws in polyaxial screws, hooks and connectors.	40.6655.233 1
	<b>Handle ratchet device (AO)</b> The device is used with drills and taps.	40.6654.001 1
	<b>Depth measure</b> The measure is used to define the depth of the holes drilled in the pedicles and occipital bone for selection of appropriate screws.	40.8348.000 1











## CHARSPINE OCT Instrument set - basic

15.0915.101

	Name	Catalogue no.	Pcs
	Container lid 9x4	14.0915.103	1
	Tray 9x4 1/2H	14.0915.201	1
	Container 9x4H	14.0915.101	1
	Container 9x4H	14.0915.102	1

CHARSPINE OCT Instrument set - additional 1  
(instruments for occipital stabilization)



15.0915.202

	Name	Catalogue no.	Pcs
	<b>Bender for occipital plates</b> The bender, together with the bender for occipital plates 40.8351.000, is used to shape occipital plates.	40.8350.000	1
	<b>Bender for occipital plates</b> The bender, together with the bender for occipital plates 40.8350.000, is used to shape occipital plates.	40.8351.000	1
	<b>Drill with joint and limiter 2.9</b> The drill is used in cases with hindered surgical access, to make a hole in the occipital bone for the 4.0mm screw.	40.8352.029	1
	<b>Drill with joint and limiter 3.4</b> The drill is used in cases with hindered surgical access, to make a hole in the occipital bone for the 4.5mm screw.	40.8352.034	1
	<b>Drill with limiter 2.9</b> The drill is used to make a hole in the occipital bone for the 4.0mm screw.	40.8353.029	1
	<b>Drill with limiter 3.4</b> The drill is used to make a hole in the occipital bone for the 4.5mm screw.	40.8353.034	1
	<b>Tap with joint 4.0</b> The tap is used in cases with hindered surgical access, to tap a hole drilled in the occipital bone for the 3.5mm screw.	40.8354.040	1
	<b>Tap with joint 4.5</b> The tap is used in cases with hindered surgical access, to tap a hole drilled in the occipital bone for the 4.5mm screw.	40.8354.045	1
	<b>Tap 4.0</b> The tap is used for tapping a hole drilled in the occipital bone for the 4.0mm screw.	40.8355.040	1
	<b>Tap 4.5</b> The tap is used for tapping a hole drilled in the occipital bone for the 4.5mm screw.	40.8355.045	1
	<b>Adjustable guide sleeve</b> The sleeve is used for regulated insertion of OC drills into occipital bone.	40.8356.000	1



**CHARSPINE OCT Instrument set - additional 1**  
*(instruments for occipital stabilization )*

15.0915.202

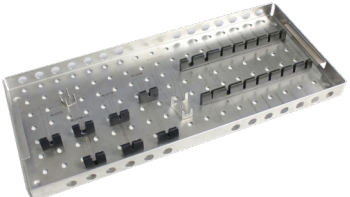
	Name	Catalogue no.	Pcs
	<b>Counter wrench</b> The wrench is used to ensure the rotational stability of the implants system when tightening up the locking screws in occipital bone.	40.8357.000	1
	<b>Screwdriver tip T15</b> The tip is used with the handle ratchet device for implantation of occipital screws.	40.8358.000	1
	<b>Screwdriver tip T15 with joint</b> The tip is used with the handle ratchet device, in cases with hindered surgical access, for implantation of occipital screws.	40.8359.000	1
	<b>Tray 9x4 1/2H</b>	14.0915.202	1



Instruments mentioned below are not included in the standard instrument set.

In order to include them to the ordered **CHARSPINE OCT** instruments, please contact your local representative or **ChM** Sales Department.

	Name	Catalogue no.
	<b>Rod trial 3.5/240</b> Rod trials are used for initial rough assessment of the size and shape of the rod and to facilitate the selection of the proper size of the spinal rod, in the spinal stabilization procedures using transpedicular screws.	40.8345.240

## 5. SURGICAL TECHNIQUE

### 5.1. PATIENT POSITIONING AND SURGICAL APPROACH

Place the patient supine with neck and head in their anatomical position in relation to the body. Ensure the stability of the positioning.

Prepare the surgical access with a median incision along the spine over the treated section, which, if necessary, can be extended by one or two levels below and above.

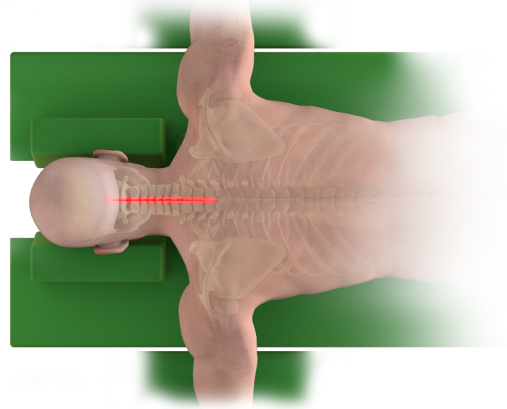

### 5.2. OCT SCREWS INSERTION

Two methods of insertion of polyaxial screws are used, depending on the cervical spine segment treated.

Use trocar [40.6099.000] to penetrate the first cortex bone of the pedicle, in the place where the polyaxial screw is to be implanted.

Select the diameter and, initially, length of the polyaxial screw, based on the X-Ray images and patient's anatomy.

Depending on the screw diameter, select the compatible drill. Drills are coded with colors corresponding to the colors of the screws:

3.5  Drill Ø2.4 [40.5777.024] – green

4.0  Drill Ø2.9 [40.5777.029] – yellow

4.5  Drill Ø3.4 [40.5777.034] – brown

Connect the selected drill with limiter [40.5777.0xx] with handle ratchet device [40.6654.001].

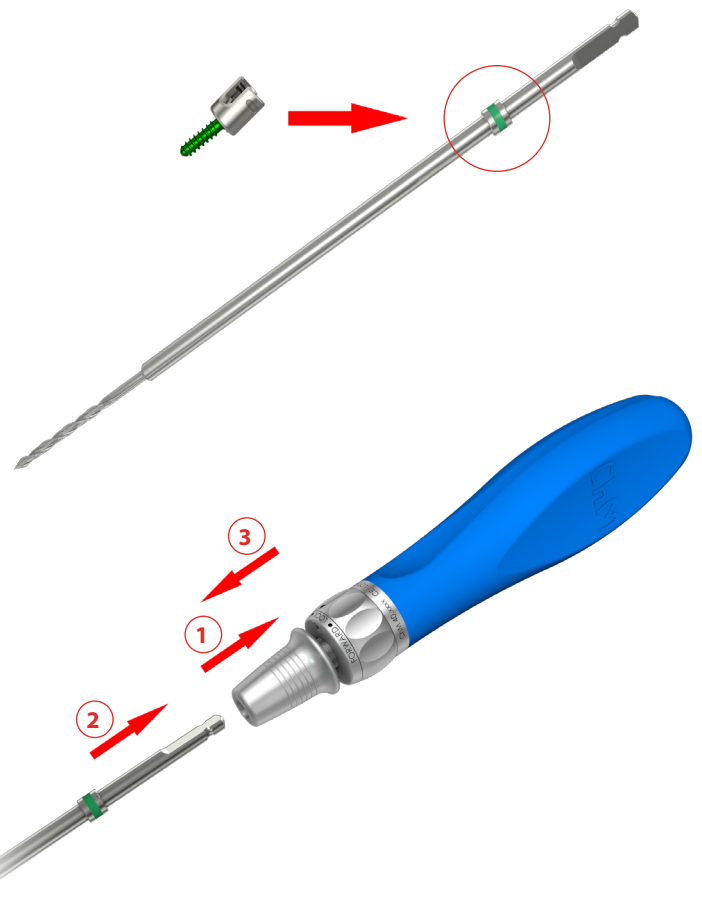
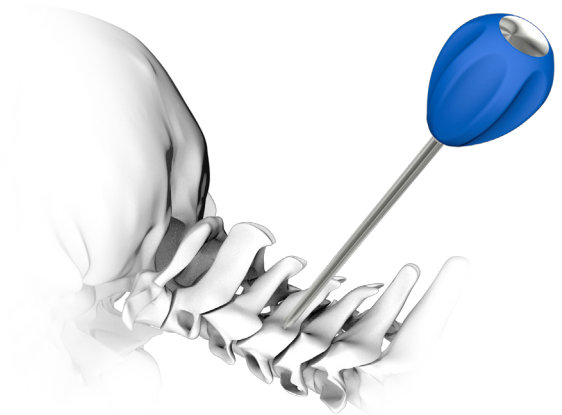

Set the adjustable guide sleeve [40.5773.000] to the selected drilling depth, equal to the length of the selected polyaxial screw or, in the case of partially threaded polyaxial screws, the thread length.

The use of the guide during drilling ensures protection of the surrounding tissue and limits the depth at which the drill is inserted into the vertebra.

Insert the drill into the adjustable guide sleeve then into the hole made by the trocar and drill the hole. Stop drilling when the drill limiter rests against the guide sleeve.



**CAUTION:** During drilling, it is recommended to take an X-Ray image to verify the drilling trajectory and depth.



Prior to the insertion of the polyaxial screw, tapping of the hole may be performed, which in the cases of very hard bone structures, will facilitate screwing.

For tapping, use taps which are also coded with colors corresponding to the colors of the screws:

3.5  Tap 3.5 [40.5778.035] – green

4.0  Tap 4.0 [40.5778.040] – yellow

4.5  Tap 4.5 [40.5778.045] – brown

For tapping, use handle ratchet device [40.6654.001].

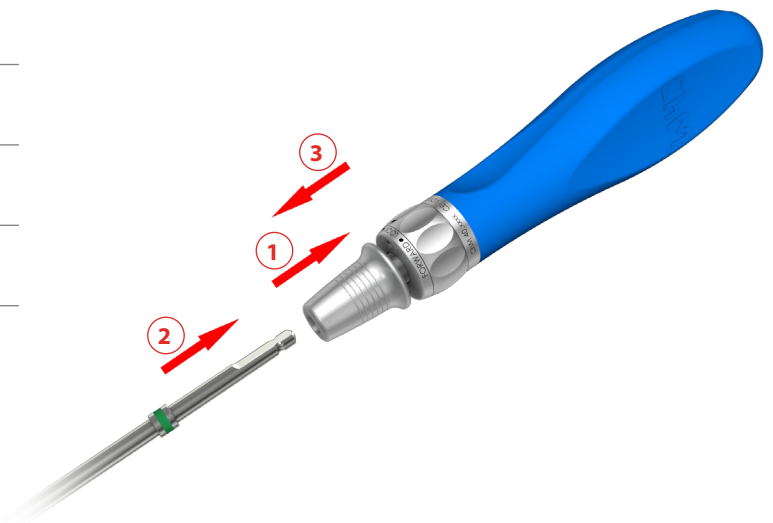

To protect the surrounding tissues and to verify the depth at which the tap was inserted, the use of adjustable guide sleeve [40.5773.000] or protective guide [40.5790.000] is recommended. When using adjustable guide sleeve [40.5773.000] for tapping, proceed similarly to drilling procedure.

When using the protective guide [40.5790.000], the insertion depth of the tap is read from the scale provided on this tap.

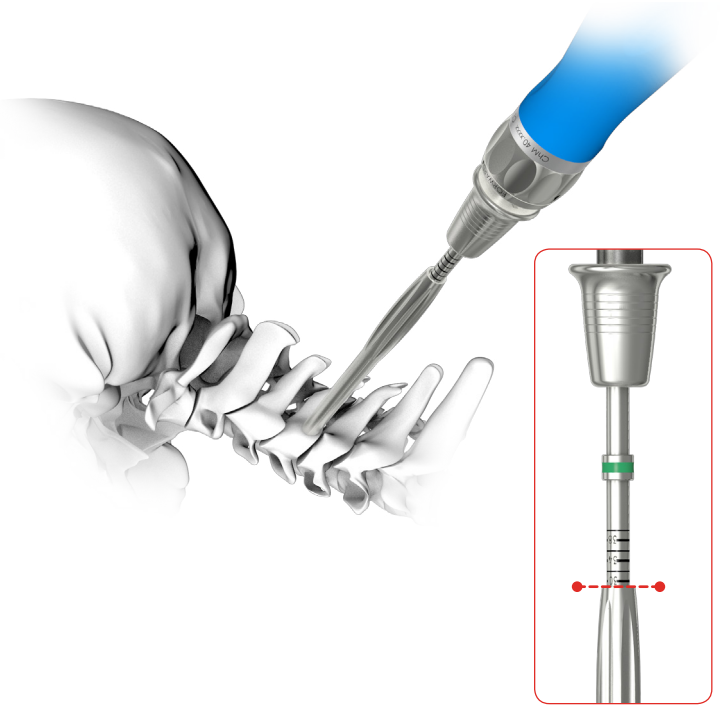

The length of the polyaxial screw can also be determined using the depth measure [40.8348.000].

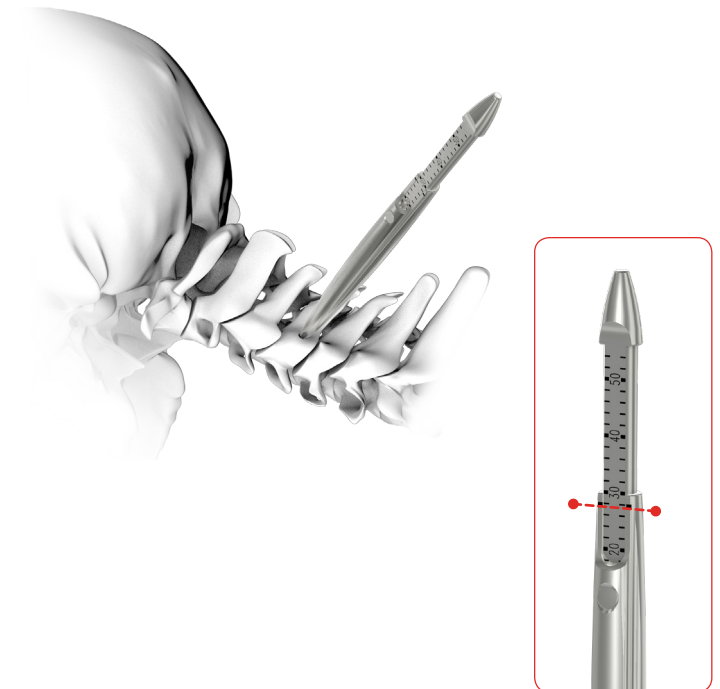

Use wrench for screw [40.5791.000] and handle ratchet device [40.6654.001] for insertion of polyaxial screws.



Insert the tip of the wrench into the socket of the tulip head of the polyaxial screw and tighten up.



**CAUTION:** If it is not possible to screw in the wrench sleeve into the tulip of the screw, the wrench tip has to be re-positioned and correctly inserted into the screw socket.

Insert the polyaxial screw into the prepared hole in the vertebra.



**CAUTION:** Only hold the sleeve [2] to support the screw insertion. Holding the wrench in its lower part (*near the screw*) may loosen the implant.

Having inserted the screw, unscrew the wrench from the tulip head of the screw and remove the wrench.

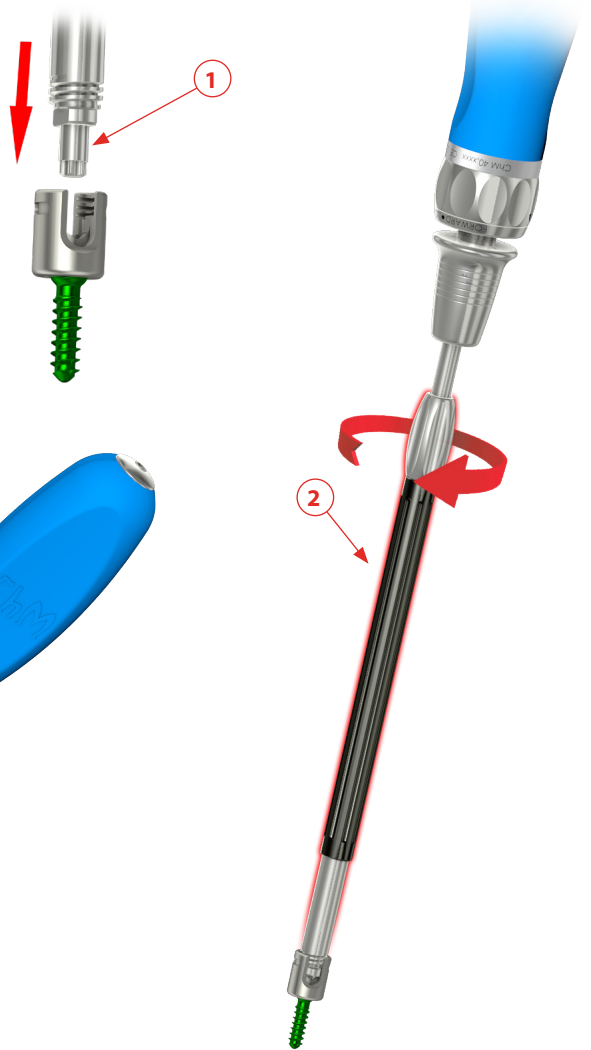

Position the tulip heads of the screws in a line along the spine so that to enable the rods to be locked in them. Use polyaxial screws holder [40.5786.000] to position the screw heads.



**CAUTION:** Remember not to tighten up the screw during insertion into the vertebra. Leave some room between the tulip head and the bone for the head to move freely.

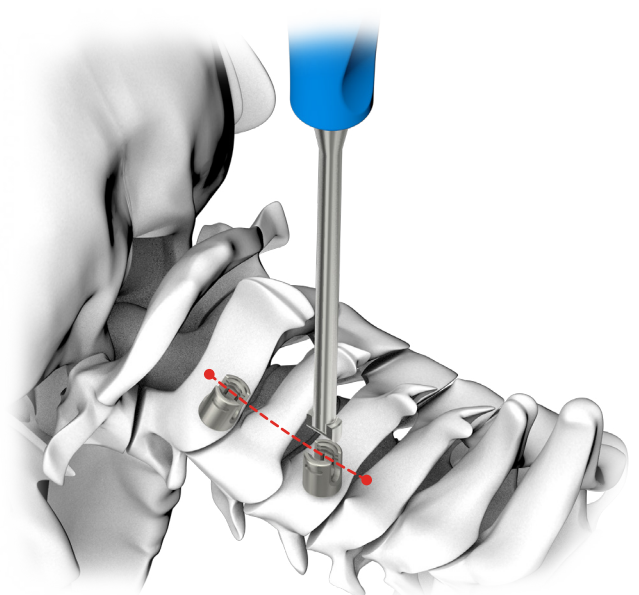
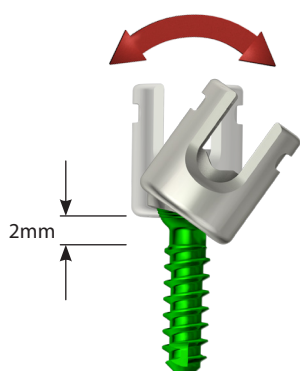

### 5.3. HOOK INSERTION

The size of the hook should be chosen according to the thickness of the vertebral arch. Use raspatory for hooks [40.5782] to chose the right size or to shape gently the bone for better positioning of the hook.

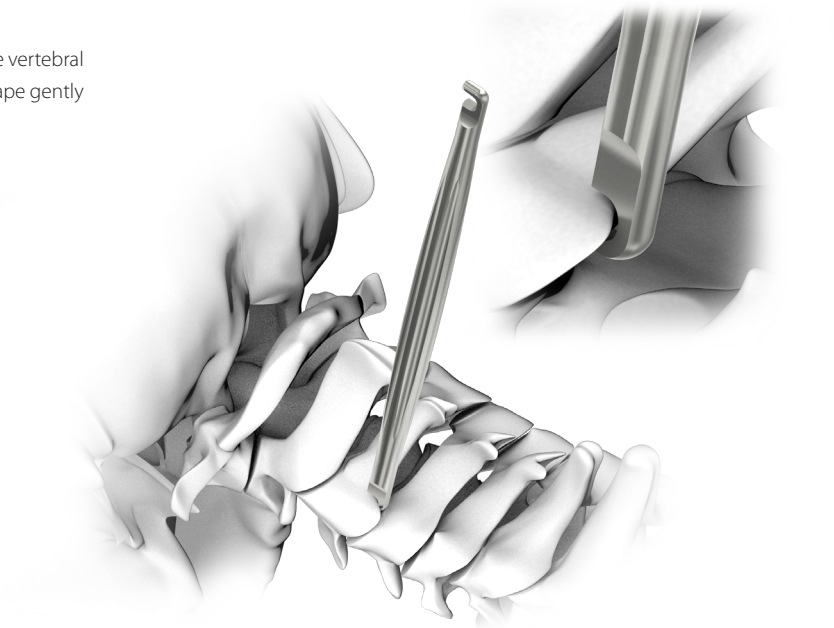

Use hook holder [40.5787.000] to install the hooks to the vertebral arches.

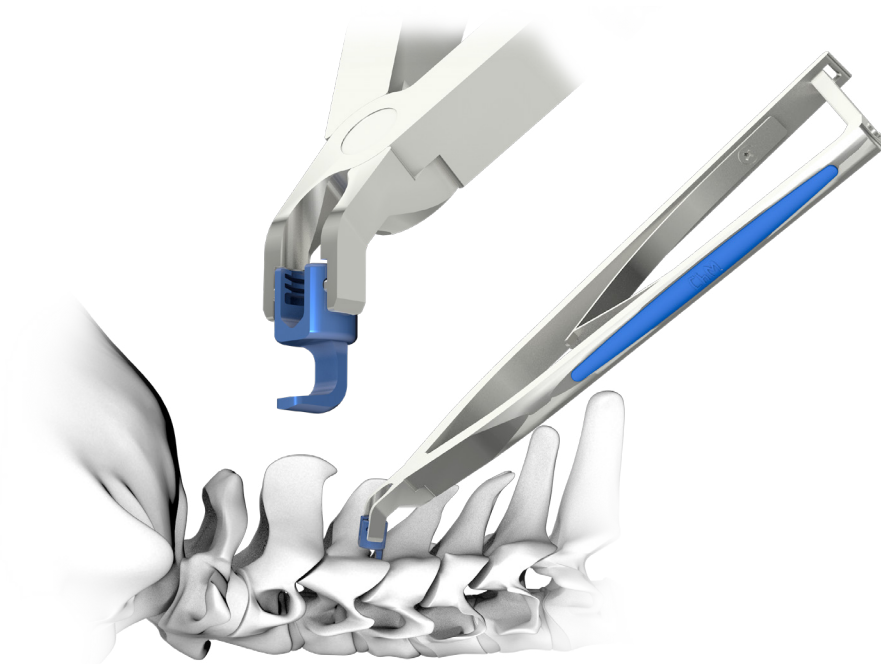

The hook holder can also be used for installing the rod in the hook and for locking of the locking screw [3.6111.000].

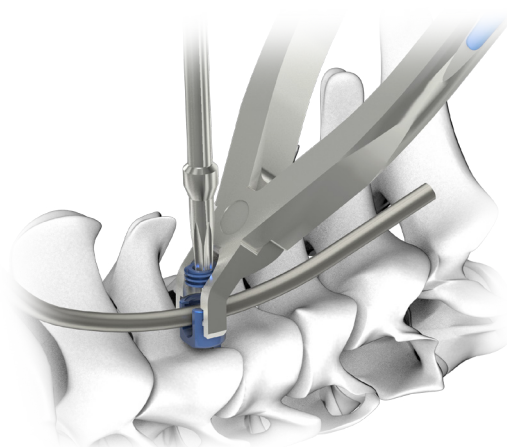

### 5.4. RODS

There are two types of rods, single diameter ( $\varnothing 3.5mm$ ) and double diameter ( $\varnothing 3.5/\varnothing 6.0mm$ ). Double-diameter rods [3.6106.xxx] allow for single stabilization with two rods systems - 3.5mm and 6mm.



**NOTE:** Stabilization using a 6.0mm rod is described in the surgical technique for the CHMSPINE2 system.

The length of the rods should be selected according to the treated segment of the spine, for the left and right sides. Make sure the rods in extreme implants gently protrude beyond their outline. However, do not leave excessively long rods whose tips could irritate surrounding tissues.

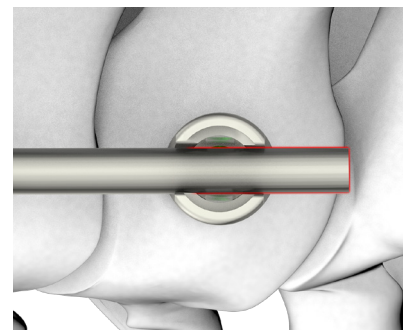
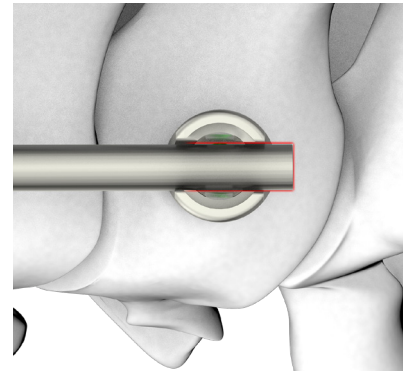
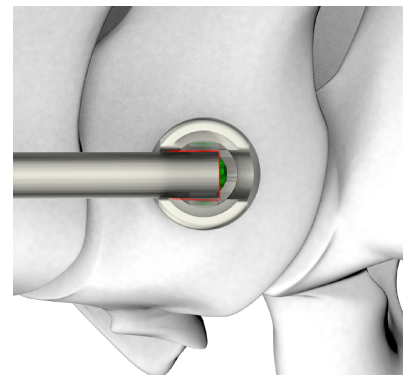

For rods trimming use hand hold rod cutter [40.5788.000].

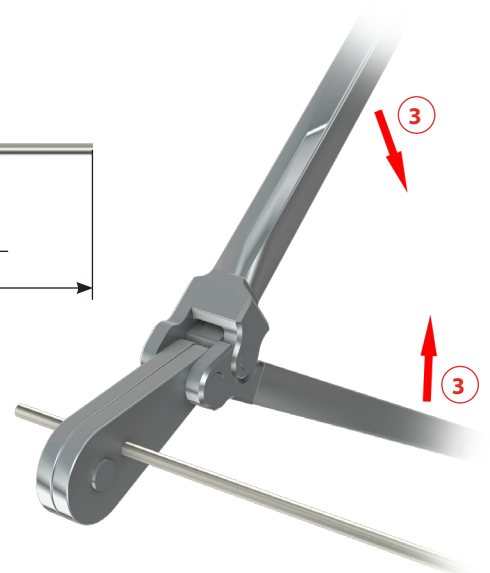
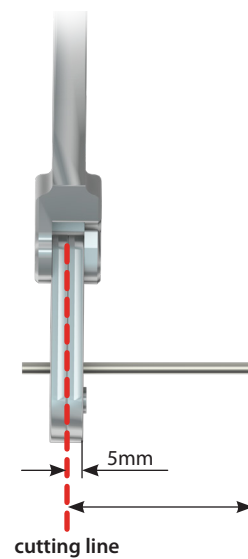
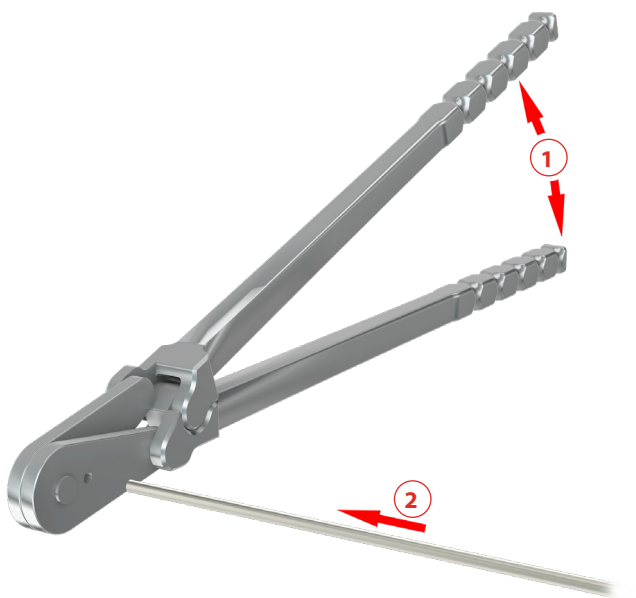

The desired spinal curvature after stabilization requires shaping of the rod - use adjustable rod bender [40.5770.000] and rod bender 3.5 left / right [40.5780.000/40.5781.000].

Set the bending radius on the bender [40.5770.000]. Place the rod between the rollers as presented and bend till desired shape is achieved.

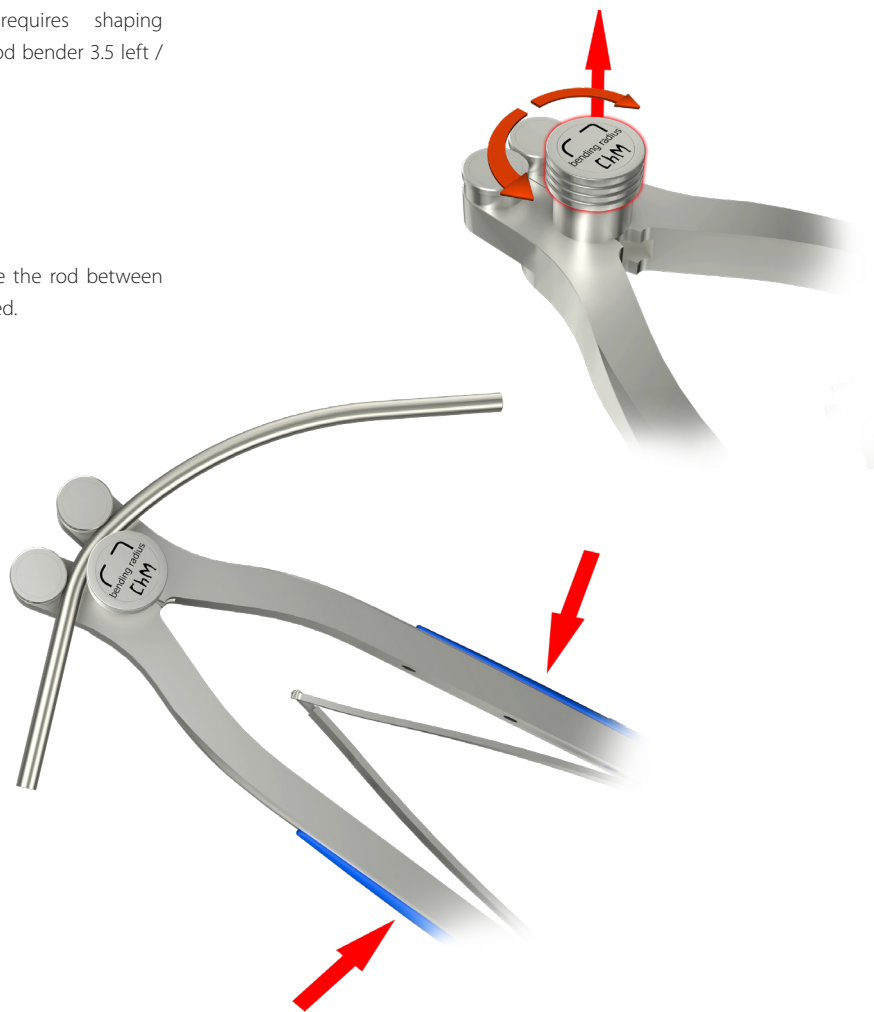

Rod benders 3.5 [40.5780.000/ 40.5781.000] are used to bend the rod *In Situ*. Slide the benders on the rod and by tilting the benders left or right, shape the rod as intended.

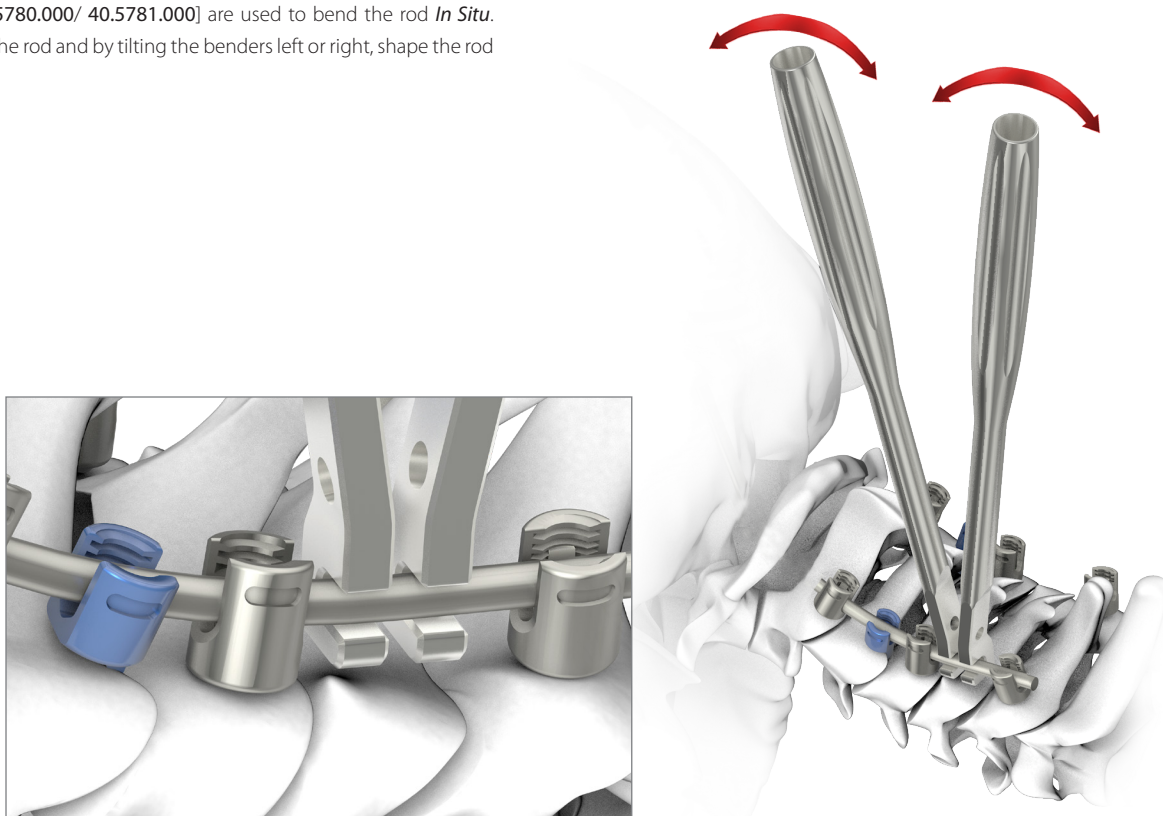



Insert the shaped rods into the tulip heads of screws and hooks. Use forceps [40.5774.000].

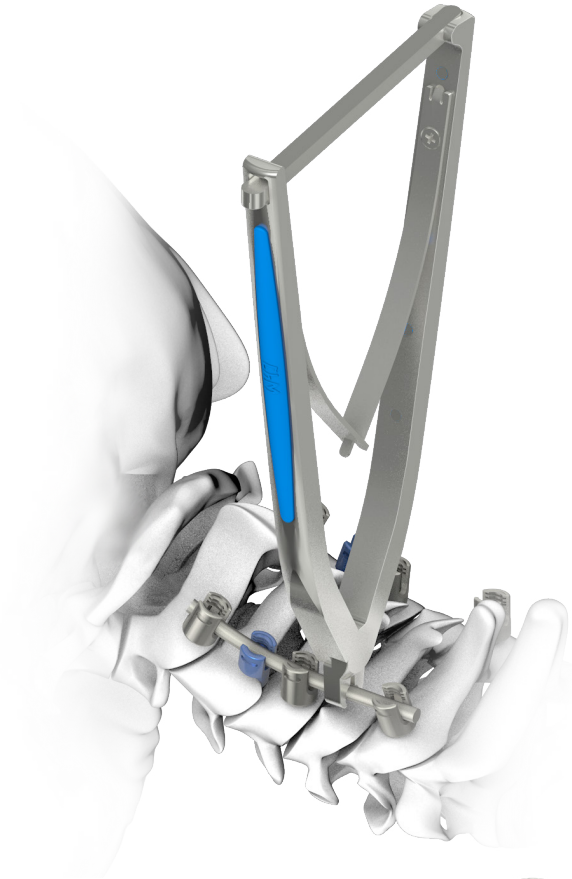

Lock the rods in the tulip heads of screws and hooks by inserting locking screws [3.6111.000] with use of the screwdriver T15 [40.5783.000]. For initial stabilization, tighten slightly.



**NOTE:** Screwdriver T15 [40.5783.000] has a conical tip that protects the screws against slipping off.



Should the rod be not correctly positioned in the tulip head (*the locking screw [3.6111.000] cannot be screwed in*), use the screw persuader [40.5776.000] to push the rod to the socket.

Make sure the clamps at the end of the persuader are fully extended.

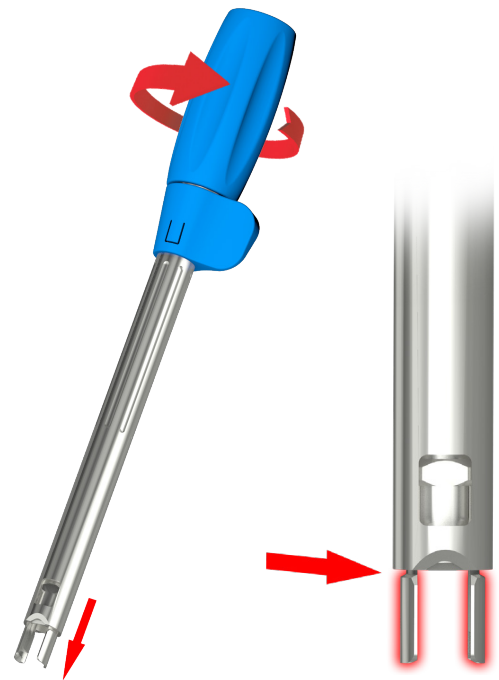

Slide the persuader onto the tulip head of the implant until it locks.

Rotate the knob to push the rod to the bottom of the tulip head.

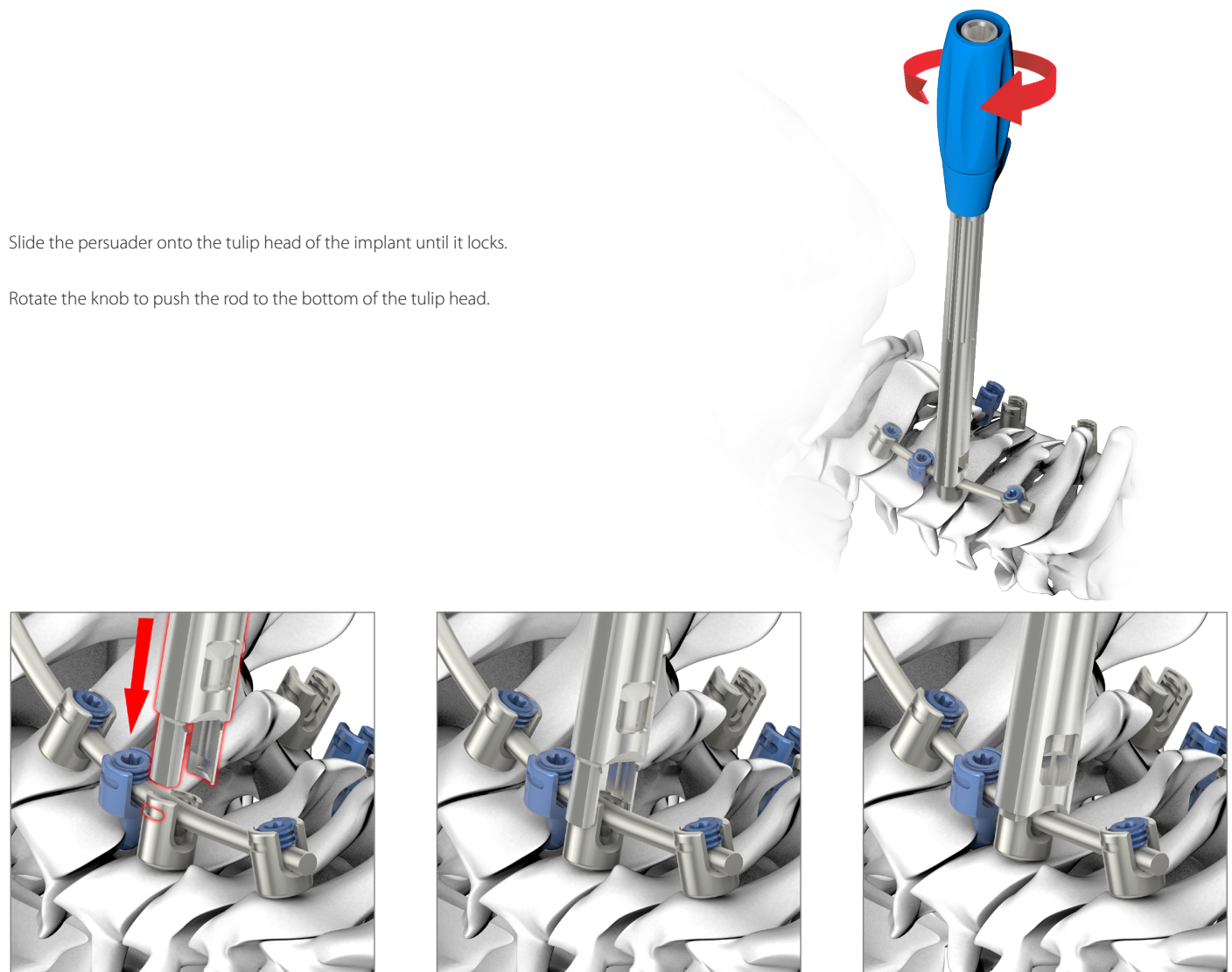

Lock the rod with the locking screw [3.6111.000] and screwdriver T15 [40.5783.000].

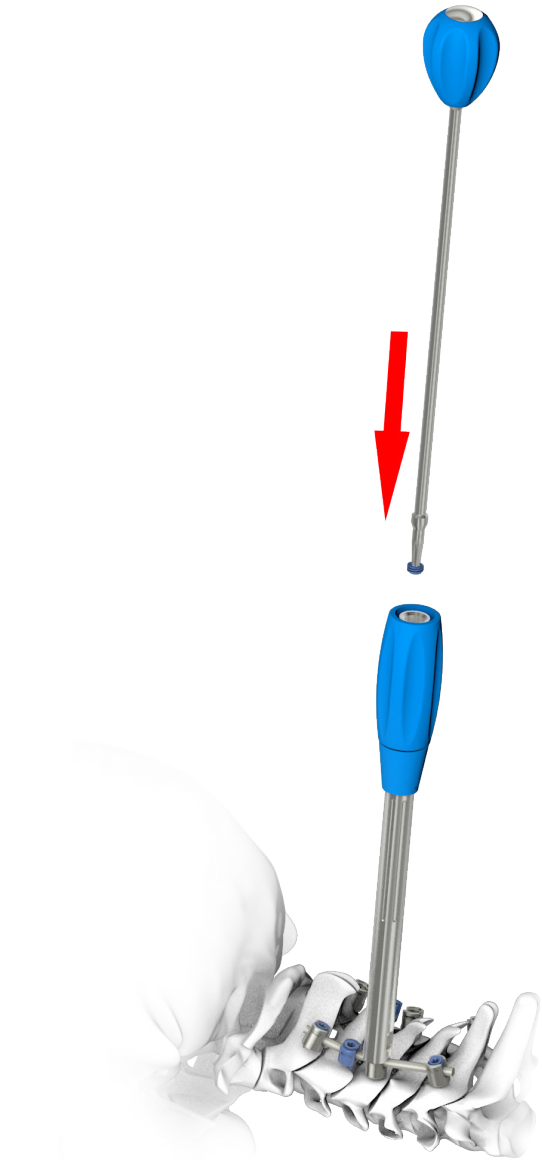

Extend the clamps of the persuader fully again and by tilting the device along the rod, remove the persuader.



**CAUTION:** Disconnecting the persuader from the implant when the clamps are not fully extended can damage the implant or instruments.

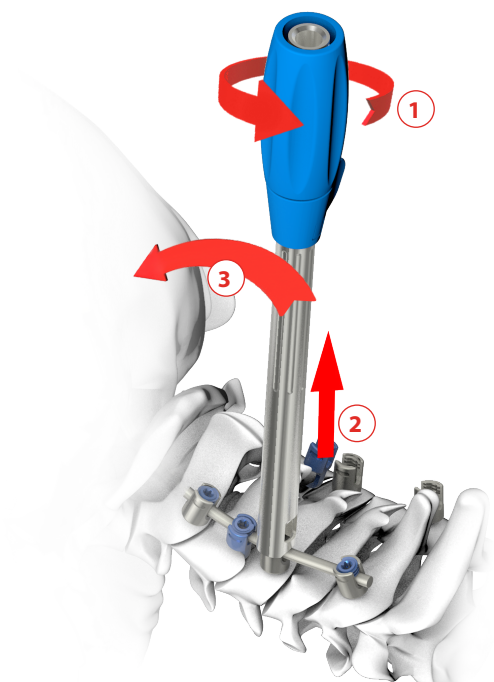

After initial locking of the rods, distraction or compression of the vertebrae based on already introduced screws or hooks may be performed. Use distraction pliers [40.5771.000] or compression pliers [40.5772.000], respectively. When performing distraction / compression, loosen the locking screw in one of the implants (located in the vertebra intended for displacement), allowing the rod to move. After distraction/ compression, lock the rod again.

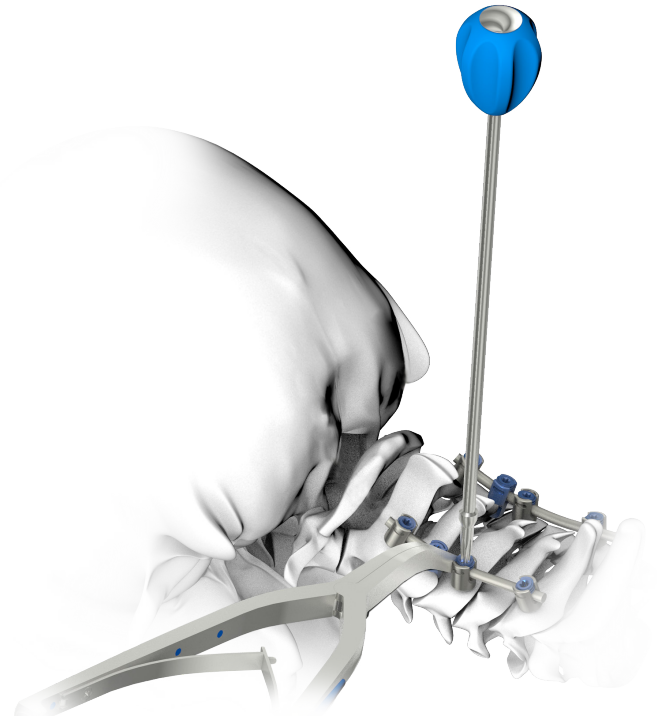

Use torque handle 3.3Nm [40.6655.233] and screwdriver tip T15 [40.5789.000] for final tightening of the locking screws [3.6111.000]. When tightening, to eliminate the forces acting on the stabilization system, use the counter wrench [40.5775.000]. Tighten the screws until a click is heard from the torque handle.



## 5.5. ARTICULATED CONNECTORS

Articulated connectors are used to increase the stability of the stabilization system. They are installed across the rods, to connect the left and right sides of the stabilization together. There are two types of articulated connectors available: installed on the rods [3.6104.0xx] and on the tulip heads of polyaxial screws [3.5996.0xx].

### Articulated connectors (ROD to ROD type) [3.6104.0xx]:

- necessary laminectomy at the connector location,
- sufficient room between tulip heads of polyaxial screws for the connector placing is required,
- the connectors level with the rods (*they do not protrude above the stabilization system*).

### Articulated connectors (HEAD to HEAD type) [3.5996.0xx]:

- no need for laminectomy,
- can be used even with a small distance between the tulip heads,
- the connectors are located above the tulip head (*they protrude above the stabilization system*).

### Articulated connectors (ROD to ROD type) [3.6104.0xx]

Select the size of the articulated connector based on the distance between the rods 3.5. After prior laminectomy, forceps [40.5774.000], may be used to place the connector on the rods.

Use torque handle 3.3Nm [40.6655.233] and screwdriver tip T15 [40.5789.000] to tighten the three blue screws of the articulated connectors. Tighten the extreme screws first. Tighten the screws until a click is heard.

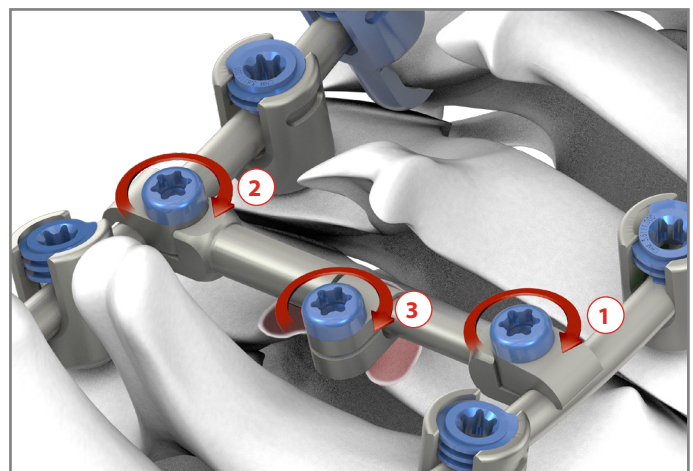
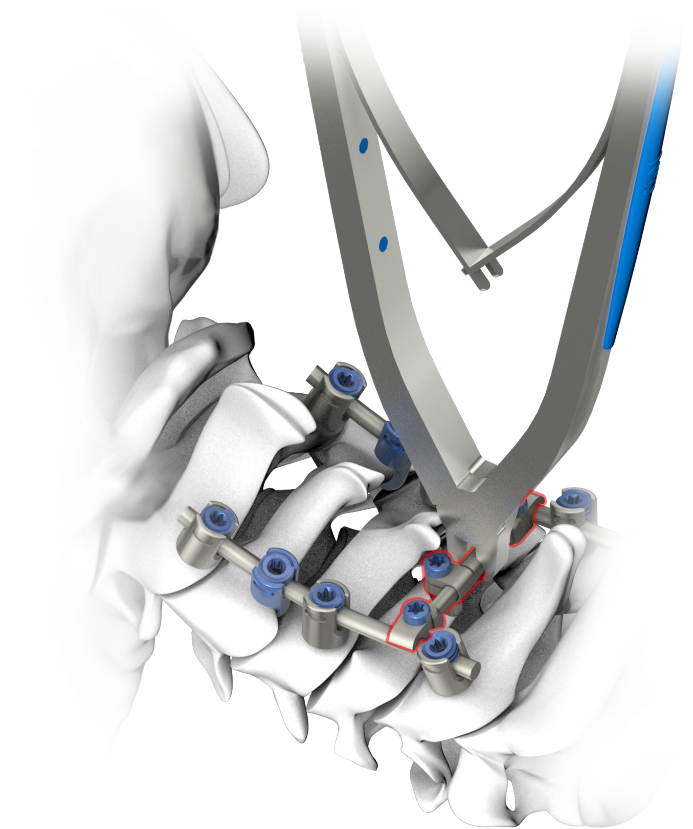

**Articulated connectors (HEAD to HEAD type) [3.5996.0xx]**

Use screwdriver T15 [40.5783.000] to insert into the heads of polyaxial screws (lying on one level), on which the articulated connector is to be installed, the locking screws [3.5990.000] (instead of the locking screws 3.6111.000). Use torque handle 3.3Nm [40.6655.233] and screwdriver tip T15 [40.5789.000] to tighten the screws until a click is heard.

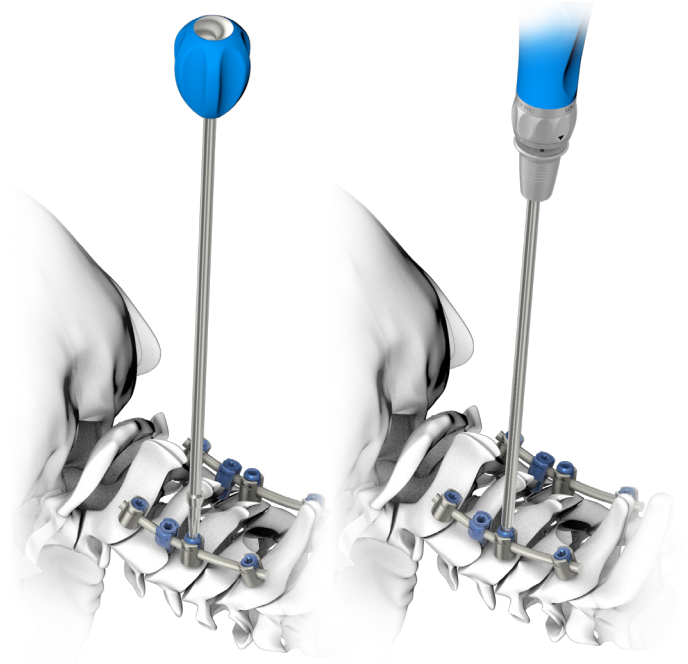

Select the size of the articulated connector based on the distance between the centers of the inserted locking screws. Forceps [40.5774.000], may be used to place the connector on the spherical ends of the locking screws [3.5990.000] that protrude above the tulip heads of polyaxial screws. Use the screwdriver T15 [40.5783.000] to insert the locking screws [3.5991.000], through the rings located at the ends of the articulated connector, into the threaded holes of the already inserted screws.

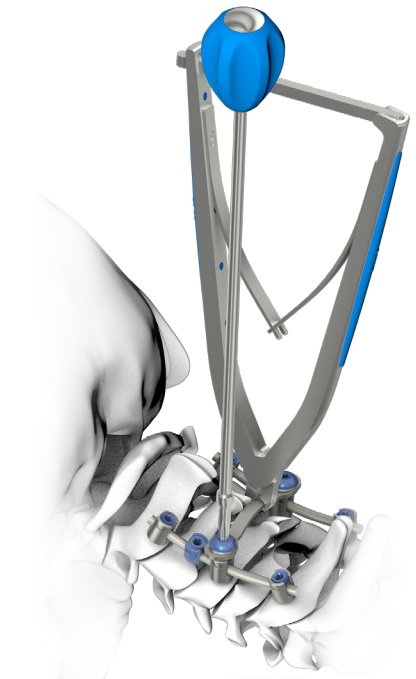

The locking screws [3.5991.000] should be tightened with the torque handle 3.3Nm [40.6655.233] and screwdriver tip T15 [40.5789.000] until a click is heard.

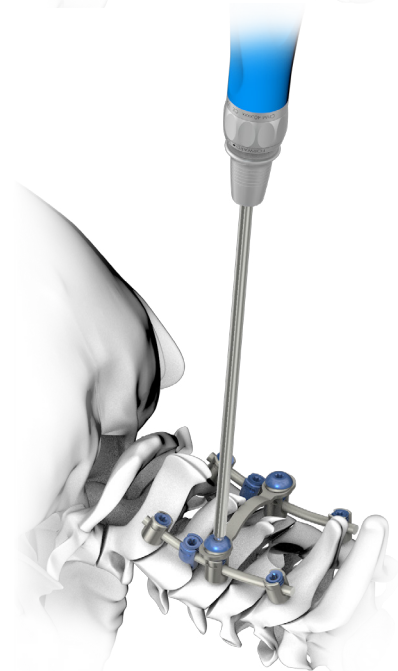

## 5.6. LATERAL CONNECTORS

The lateral (*offset*) connectors allow the offset of the screw in relation to the rod. Final locking should be performed with torque handle 3.3Nm [40.6655.233] and screwdriver tip T15 [40.5789.000] until a click is heard.

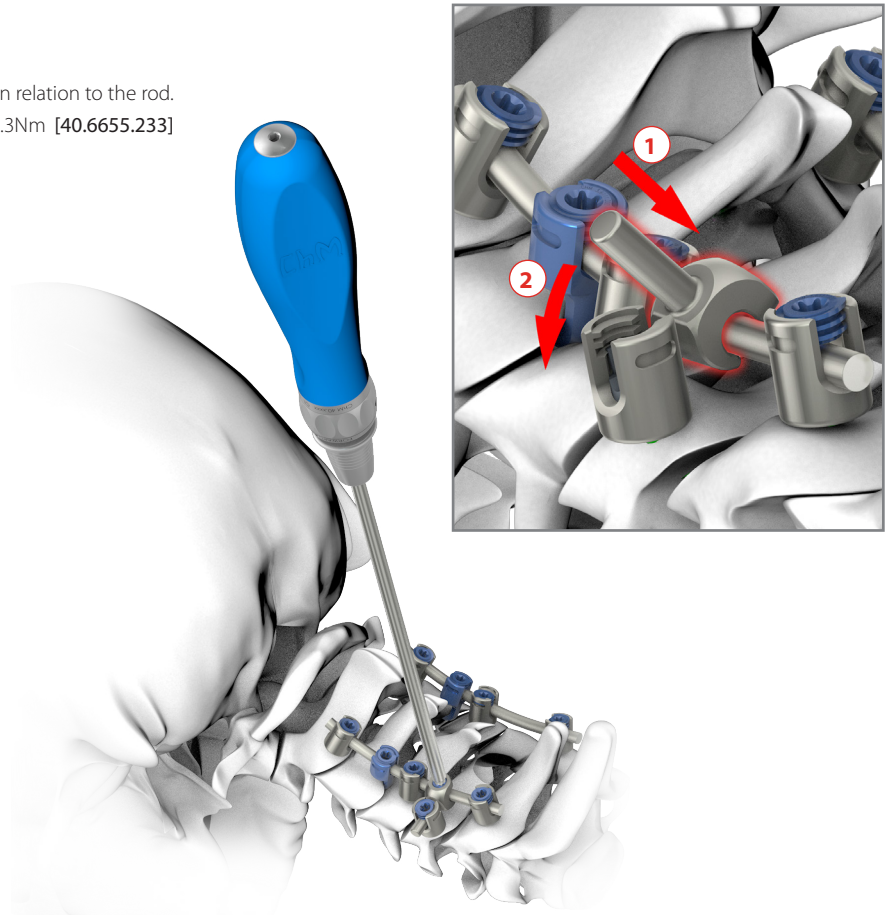

## 5.7. AXIAL AND PARALLEL CONNECTORS

Axial and parallel connectors allow for:

- extension of stabilization (*e.g. already performed*),
- connection of two stabilizations based on rods of different diameters,
- lateral offset of part of the stabilization (*e.g. during transition of the stabilization from the thoracic to cervical spine*).

Final locking should be performed with torque handle 3.3Nm [40.6655.233] and screwdriver tip T15 [40.5789.000] by tightening of the screws in the connectors, until a click is heard.

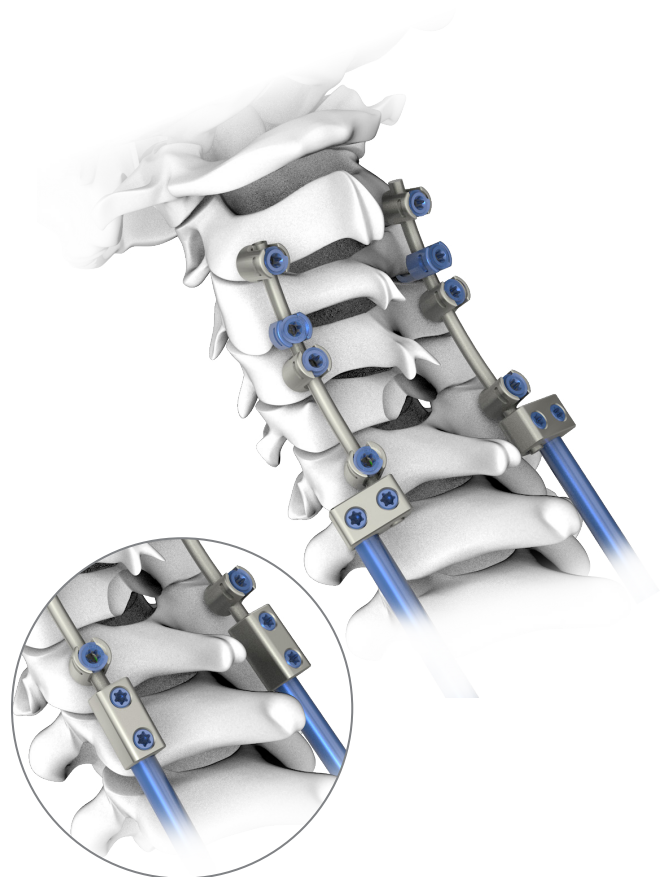

## OCCIPITAL STABILIZATION

The **CHARSPINE OCT** system offers a full set of implants and instruments necessary to perform cervical-occipital stabilization. The set includes two types of occipital plates:

- Occipital plate [3.6107] implanted in the midline of the occiput,
- Bilateral occipital plate [3.5995] implanted in pairs on the left and right site in relation to the midline.

The occipital plates are implanted when screws and hooks have already be inserted.

### 5.8. STABILIZATION USING OCCIPITAL PLATE [3.6107]

The occipital plate [3.6107] is implanted below the external occipital protuberance (EOP), symmetrically to the midline passing through the EOP and dividing the occiput into two equal parts. At this place, the thickness of the bone is the largest so that the best fixation of the plate in the bone structures is obtained.



It is recommended to preoperatively take an X-Ray image of the occiput in the lateral projection and to measure its thickness of the bone below the EOP (in the place where the plate will be attached). Based on the thickness measured, select the length of the occipital screws.

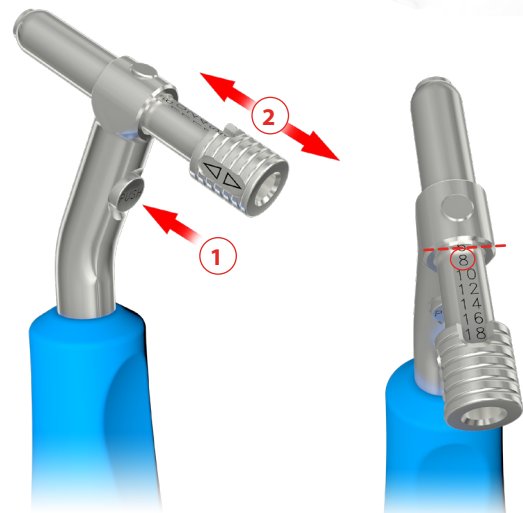
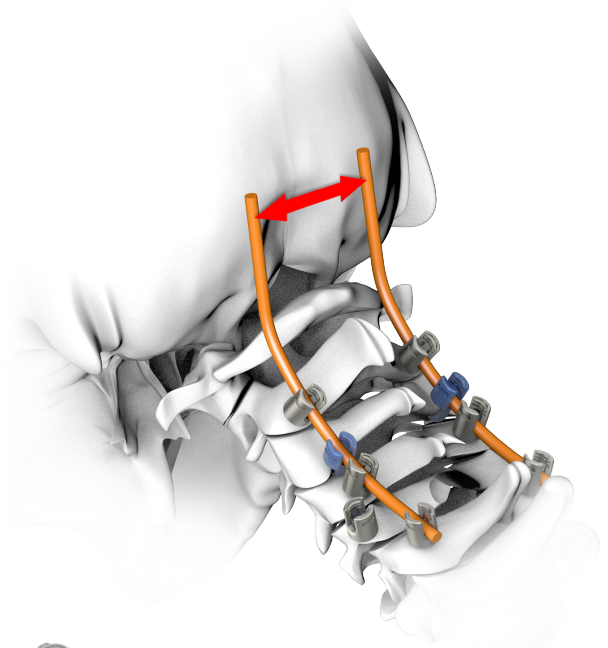
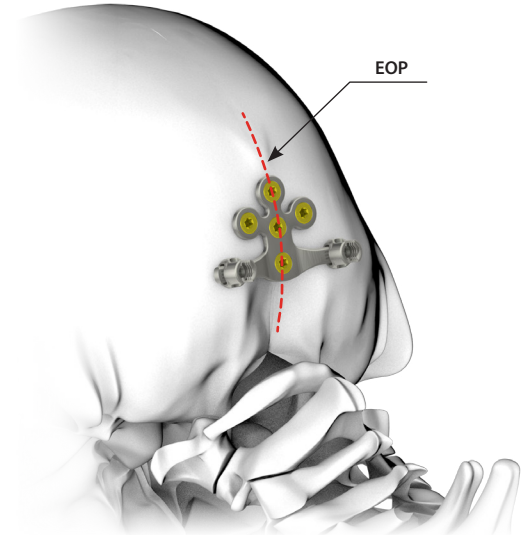

Set the drilling depth on the adjustable guide sleeve [40.8356.000] to the length of the selected occipital screws.



Connect the adjustable guide sleeve [40.8356.000] to the chosen hole of the occipital plate until a click is felt.



**CAUTION:** It is recommended to insert the first screw into the central hole of the plate. This will allow for symmetrical placement of the plate in relation to the occiput and will stabilize it when drilling subsequent holes and inserting other screws.

Position the plate on the occipital bone. If there is a need for a better fit of the plate to the occiput, a gentle bone surface resection and/ or shaping of the plate can be performed.



**CAUTION:** Do not remove bone tissue where the screws will be inserted. This can significantly weaken the anchoring of screws in bone.

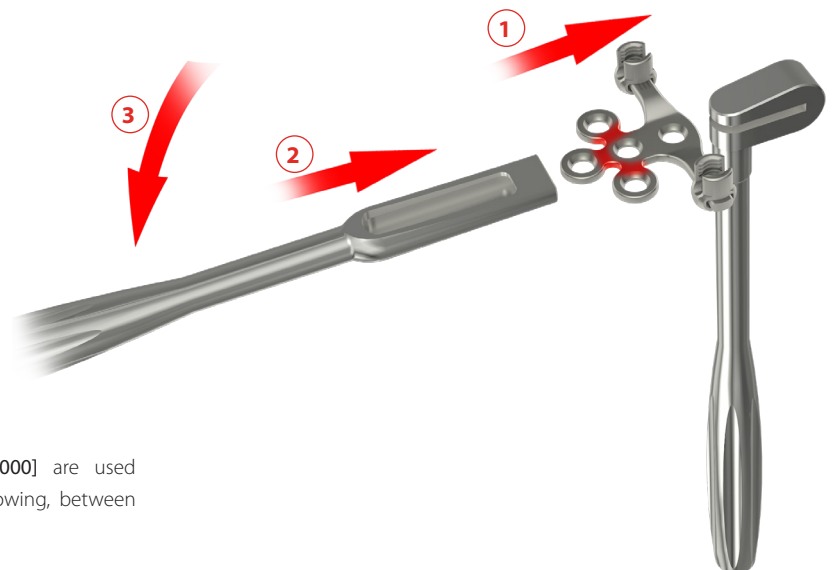
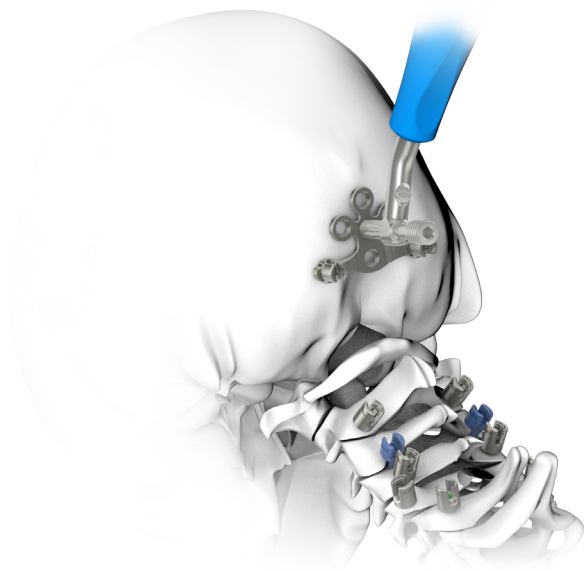
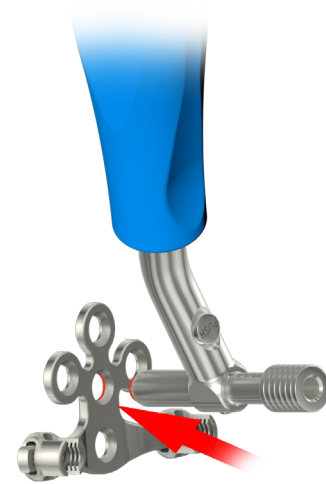

The benders for occipital plates [40.8350.000], [40.8351.000] are used for the plate shaping. The plate is shaped in places of narrowing, between the three outer holes for occipital screws and the plate body.



**CAUTION:** Excessive bending can lead to a crack or complete breakage. Do not exceed an angle of 15°. After bending, do not bend the plate back. Shaping should be performed on the necks connecting the holes for screws with the plate body.

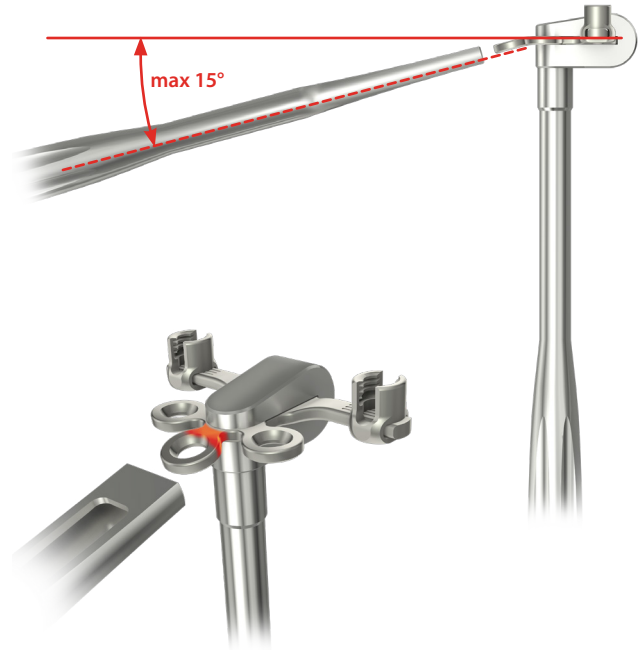







Select the appropriate drill diameter, based on the diameter of the selected occipital screws.



**CAUTION:** Screws with a diameter of Ø4.5 are recommended to be used as emergency screws only.



**NOTE:** Drills come in two versions: straight and articulated. In the case of hindered access, the articulated drill can be used.

4.0			40.8352.029
			40.8353.029
4.5			40.8352.034
			40.8353.034



**CAUTION:** Only use drills listed above to perform holes in the occipital bone. The adjustable guide sleeve [40.8356.000] has protection against the use of other drills provided in the CHARSPINE OCT instrument set.

Connect the selected drill to the handle ratchet device [40.6654.001] and, through the adjustable guide sleeve [40.8356.000], drill a hole in the occiput. The desired depth of drilling is reached when the limiter of the drill rests against the guide sleeve.



**CAUTION:** Before drilling, make sure the adjustable guide sleeve [40.8356.000] is set to the right drilling depth!

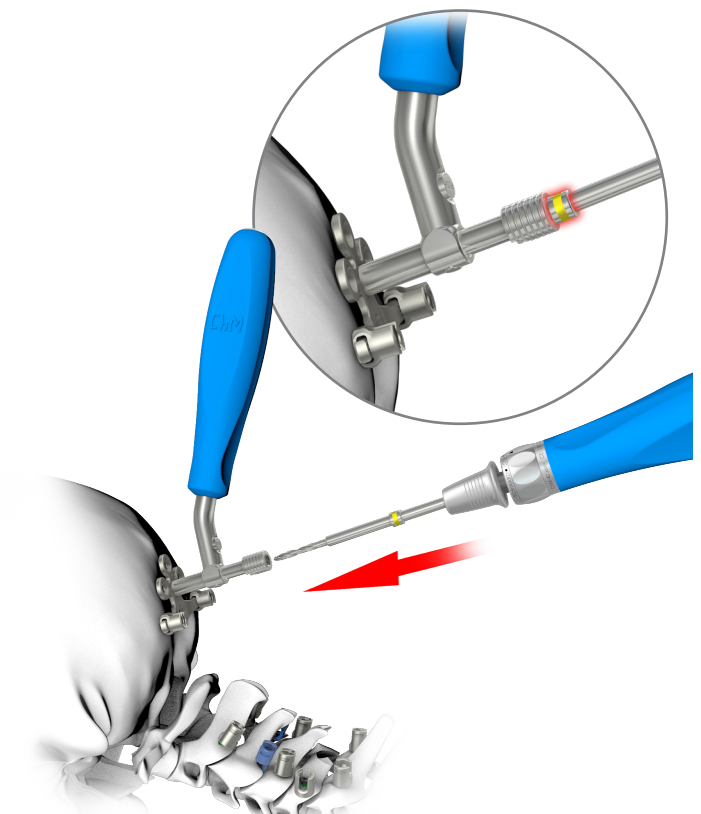

After drilling the hole, to facilitate the insertion of the screw, it is recommended to tap it. Choose the right tap with limiter based on the diameter of the selected occipital screws.



**NOTE:** Taps come in two versions: straight and articulated. In the case of hindered access, the articulated tap can be used.









**CAUTION:** Only use taps listed above to thread holes in the occipital bone. The adjustable guide sleeve [40.8356.000] has protection against the use of other taps provided in the **CHARSPINE OCT** instrument set.

Connect the selected tap to the handle ratchet device [40.6654.001] and, through the adjustable guide sleeve [40.8356.000], tap a hole in the occiput. The desired depth of tapping is reached when the limiter of the tap rests against the guide sleeve.



**CAUTION:** Before tapping, make sure the adjustable guide sleeve [40.8356.000] is set to the right tapping depth!

Use screwdriver tip T15 [40.8358.000] or screwdriver tip T15 with joint [40.8359.000] and handle ratchet device [40.6654.001] to attach the plate to the occiput with the first screw inserted into the already performed hole.

4.0		 Tap with joint 4.0	40.8354.040
		 Tap 4.0	40.8355.040
4.5		 Tap with joint 4.5	40.8354.045
		 Tap 4.0	40.8355.045

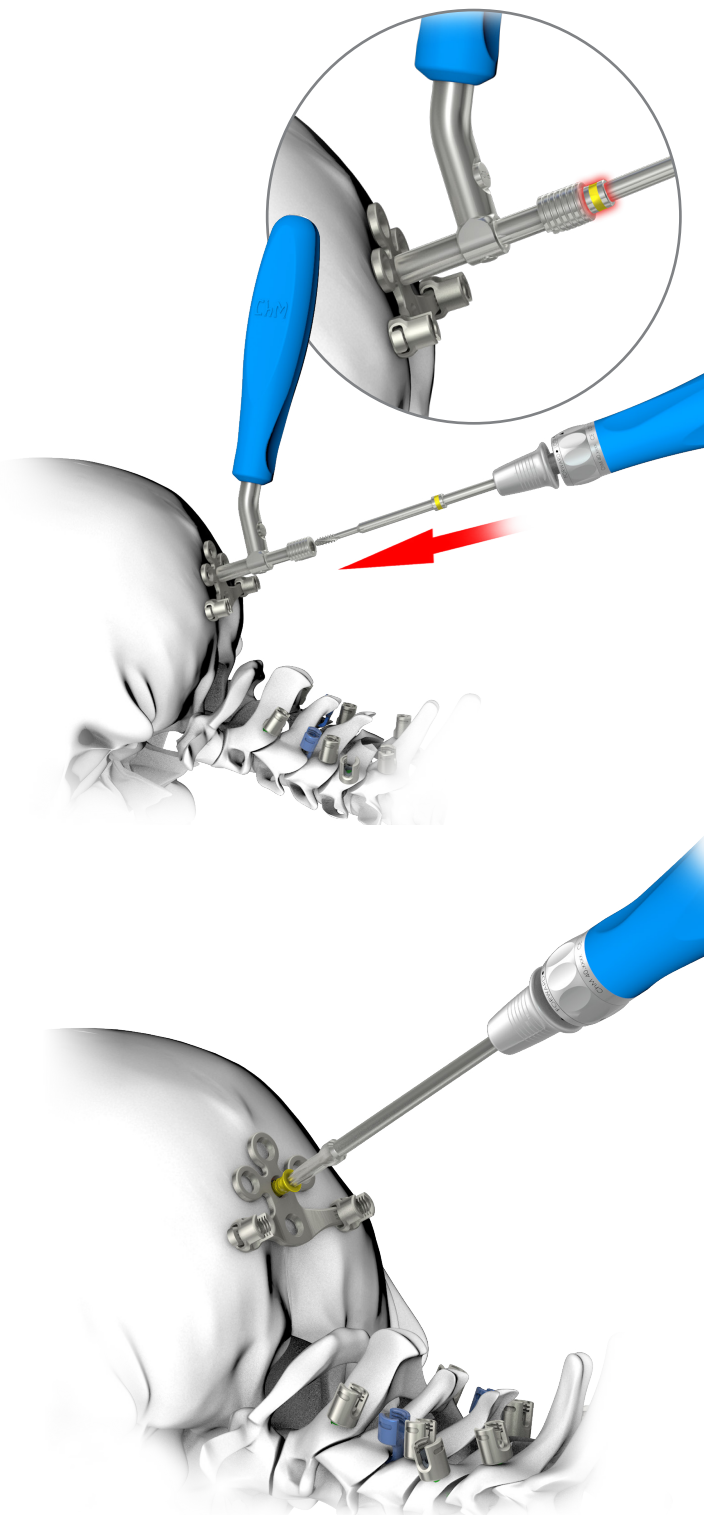



After initial plate stabilization, perform the remaining four holes and insert the screws, finally attaching the plate to the occiput, in accordance with the procedure described above.

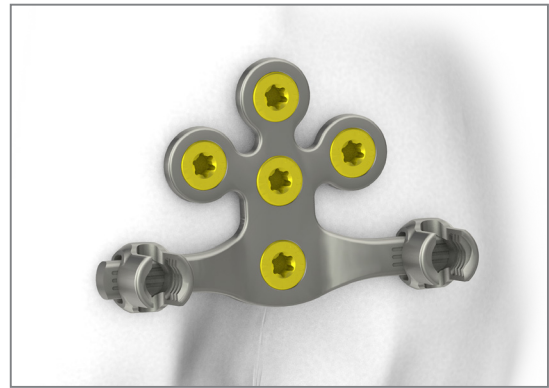

Shape the rods properly and place in the tulip heads of the implants. Insert locking screws [3.6111.000] into screws, hooks and occipital plate and lock initially the rods. For insertion, use screwdriver tip T15 [40.8358.000] and torque handle 3.3Nm [40.6655.233]. Tighten the screws slightly for initial stabilization.

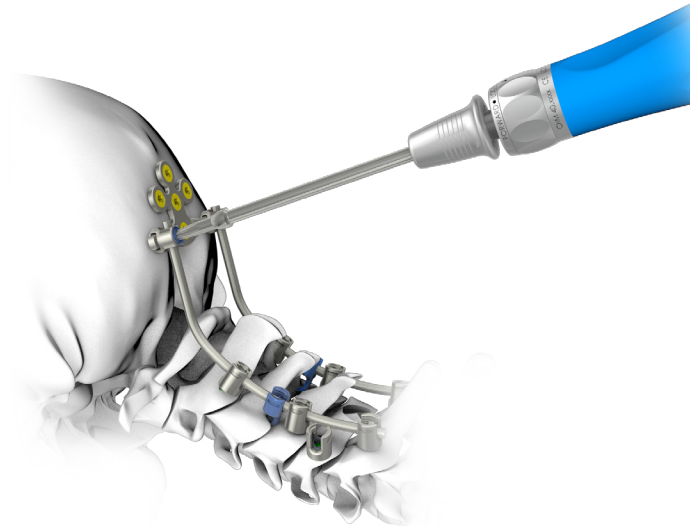

For final locking of the occipital plate on rods, use additionally counter wrench [40.8357.000]. Tighten the screw until a click is heard.

Lock the remaining implants according to section 5.4 of this guide.

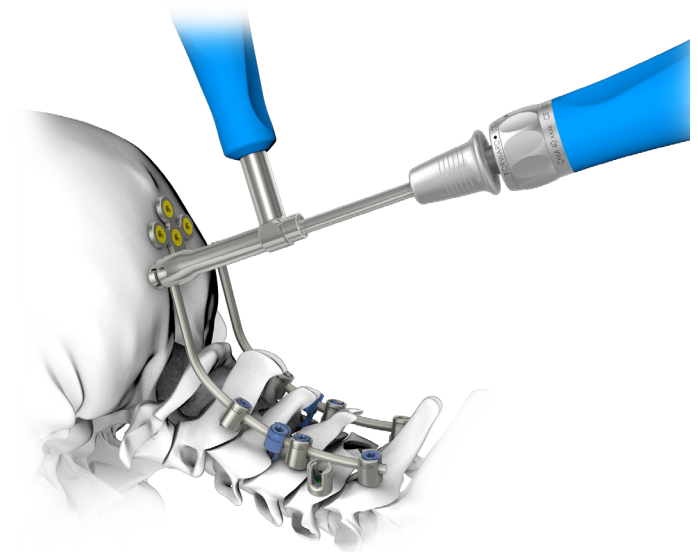

## 5.9. STABILIZATION USING BILATERAL OCCIPITAL PLATE [3.5995]

The bilateral occipital plate consists of a rod part for stabilization of cervico-thoracic spine (*no additional  $\varnothing 3.5$  rods required*) and a plate part which is anchored with the screws to the occiput.

The bilateral occipital plates are always used in pairs. They should be positioned symmetrically on the left and right side of the occiput, as close as possible to its midline, so that the first upper holes of the plates are at or slightly above the External Occipital Protuberance (EOP).

Use the adjustable rod bender [40.5770.000] to shape the rod part of the plate, as it is described in section 5.4 of this manual, in order to obtain correct curvature of the spine after stabilization.

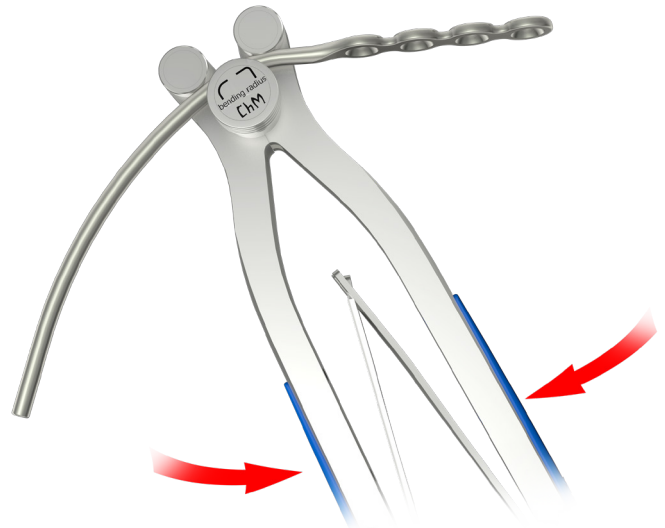

Use benders for occipital plates [40.8350.000], [40.8351.000] for shaping the plate part. The plate should be profiled in places of narrowing between the holes for occipital screws.



**CAUTION:** Excessive bending can lead to a crack or complete breakage. Do not exceed an angle of 15°. After bending, do not bend the plate back.

Insert the profiled plate into the tulip head of the screws and hooks with the plate part positioned on the occiput.  
 Forceps [40.5774.000] can be used.

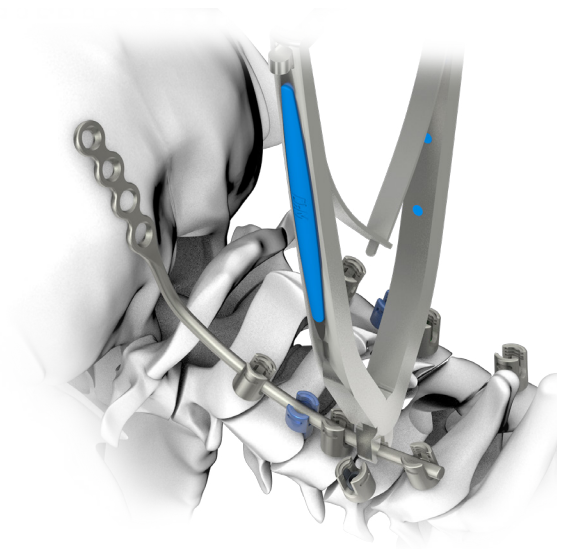

Set the drilling depth on the adjustable guide sleeve [40.8356.000] to the length of the selected occipital screws.

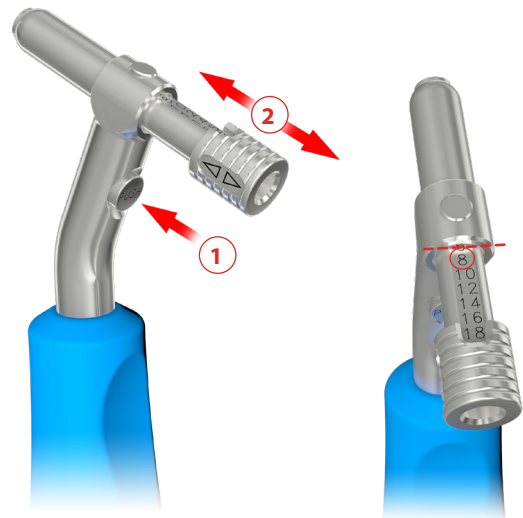

Connect the adjustable guide sleeve [40.8356.000] to the chosen hole of the bilateral occipital plate until a click is felt.



**CAUTION:** It is recommended to insert the first screw into the last (bottom) hole of the plate. Thanks to this, during insertion of other screws, the plate (rod part) will not change its position in relation to other implants.

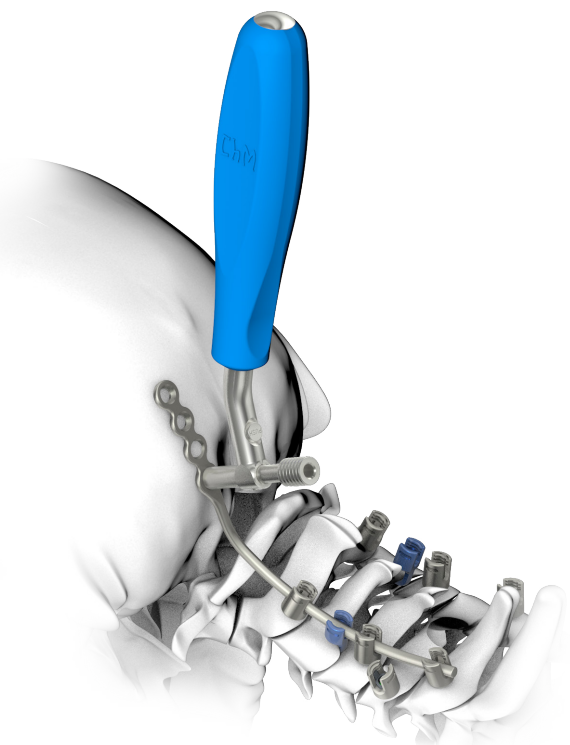

Select the appropriate drill diameter, based on the diameter of the selected occipital screws.



**CAUTION:** Screws with a diameter of Ø4.5 are recommended to be used as emergency screws only.



**NOTE:** Drills come in two versions: straight and articulated. In the case of hindered access, the articulated drill can be used.



**CAUTION:** Only use drills listed above to perform holes in the occipital bone. The adjustable guide sleeve [40.8356.000] has protection against the use of other drills provided in the CHARSPINE OCT instrument set.

Connect the selected drill to the handle ratchet device [40.6654.001] and, through the adjustable guide sleeve [40.8356.000], drill a hole in the occiput. The desired depth of drilling is reached when the limiter of the drill rests against the guide sleeve.



**CAUTION:** Before drilling, make sure the adjustable guide sleeve [40.8356.000] is set to the right drilling depth!



After drilling the hole, to facilitate the insertion of the screw, it is recommended to tap it. Choose the right tap with limiter based on the diameter of the selected occipital screws.





**NOTE:** Taps come in two versions: straight and articulated. In the case of hindered access, the articulated tap can be used.

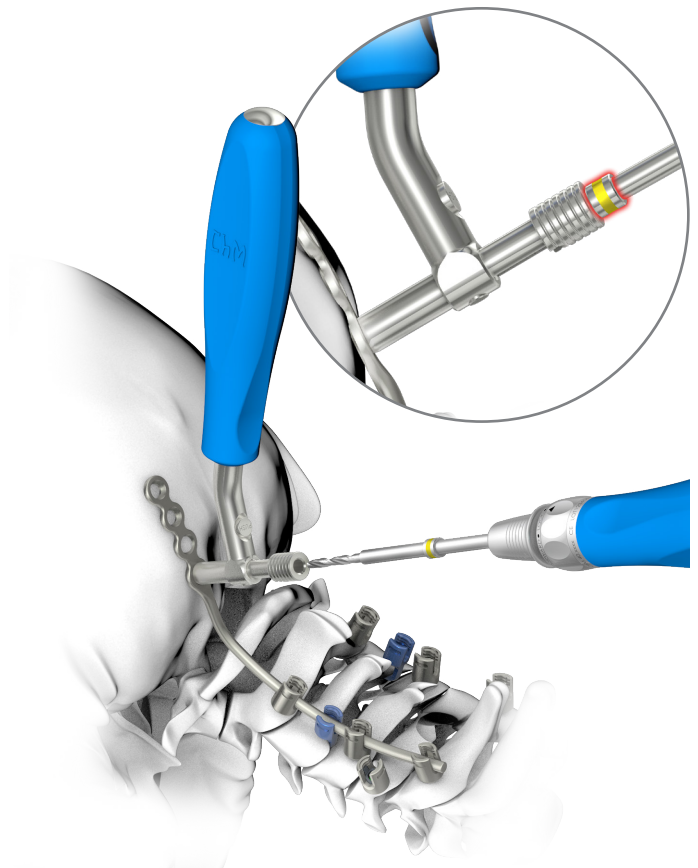

**CAUTION:** Only use taps listed above to thread holes in the occipital bone. The adjustable guide sleeve [40.8356.000] has protection against the use of other taps provided in the CHARSPINE OCT instrument set.

4.0		Drill with joint and limiter 2.9	40.8352.029
		Drill with limiter 2.9	40.8353.029
4.5		Drill with joint and limiter 3.4	40.8352.034
		Drill with limiter 3.4	40.8353.034



4.0		Tap with joint 4.0	40.8354.040
		Tap 4.0	40.8355.040
4.5		Tap with joint 4.5	40.8354.045
		Tap 4.0	40.8355.045

Connect the selected tap to the handle ratchet device [40.6654.001] and, through the adjustable guide sleeve [40.8356.000], tap a hole in the occiput. The desired depth of tapping is reached when the limiter of the tap rests against the guide sleeve.



**CAUTION:** Before tapping, make sure the adjustable guide sleeve [40.8356.000] is set to the right tapping depth!

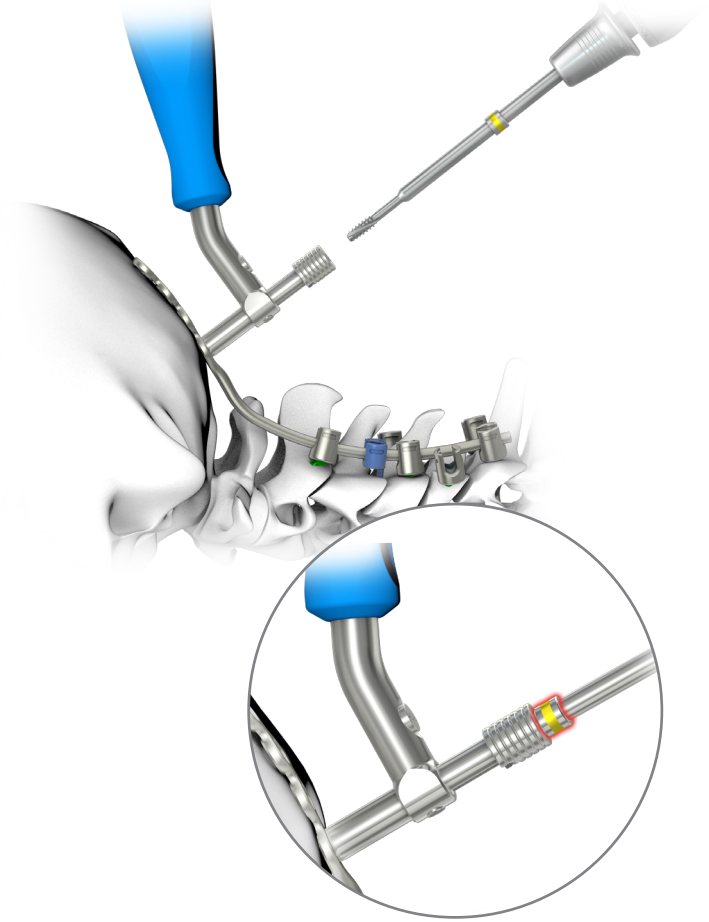

Use screwdriver tip T15 [40.8358.000] or screwdriver tip T15 with joint [40.8359.000] and handle ratchet device [40.6654.001] to attach the plate to the occiput with the first screw inserted into the already performed hole.

Perform the remaining holes and insert the screws, securing the plate to the occiput.

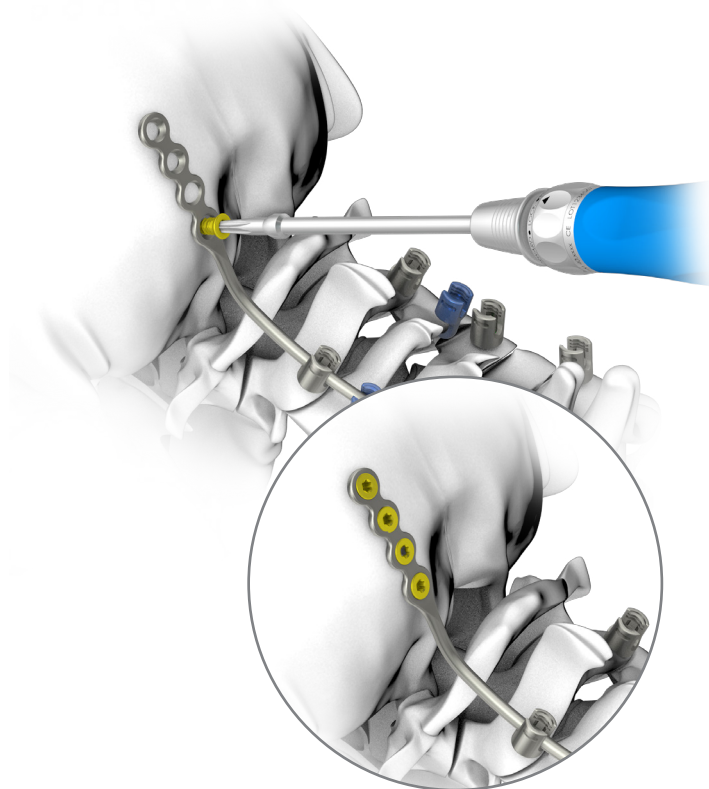





Repeat the procedure for the other plate.

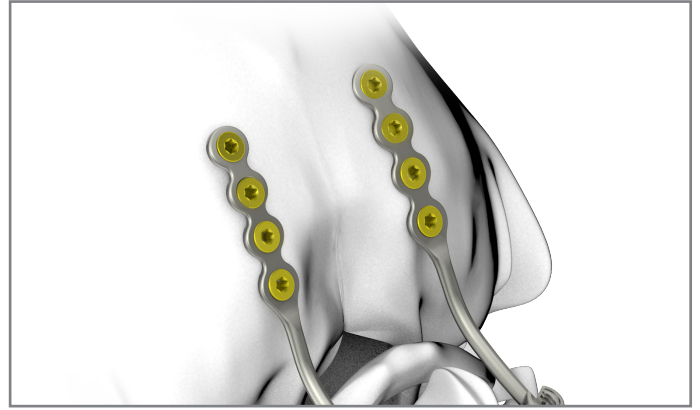

Perform the final stabilization locking the remaining implants according to section 5.4 of this manual.

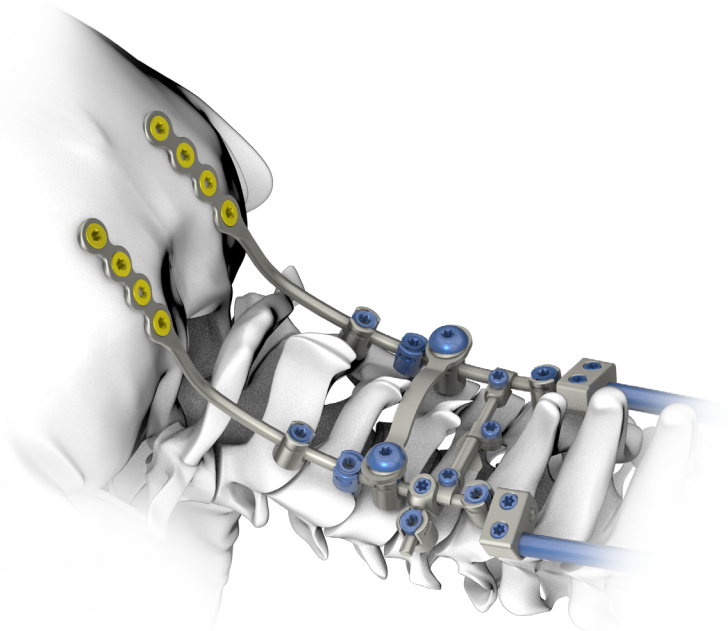





**ChM sp. z o.o.**

Lewickie 3b  
16-061 Juchnowiec Kościelny  
Poland

tel. +48 85 86 86 100

fax +48 85 86 86 101

chm@chm.eu

www.chm.eu



CE 0197