

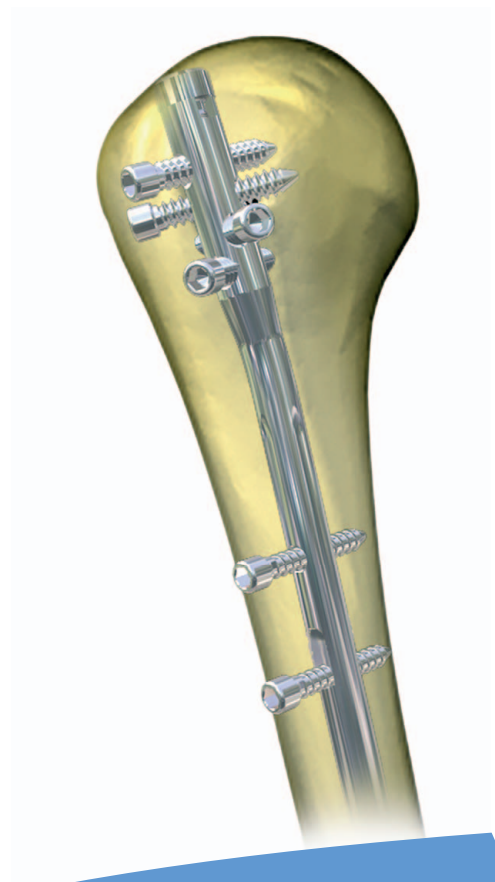





CHM[®]

CHARFIX^{system}

INTRAMEDULLARY OSTEOSYNTHESIS OF HUMERUS

- *IMPLANTS*
- *INSTRUMENT SET 40.5020.500*
- *SURGICAL TECHNIQUE*



SYMBOLS DESCRIPTIONS	
	Caution - pay attention to the particular proceeding.
	Perform the activity with X-Ray control.
	Consult the Instructions For Use.
	Proceed to the next stage.
	Return to the specified stage and repeat the activity.

www.chm.eu

Document No ST/04G
Date of issue 02.08.2010
Review date 18.08.2015

The manufacturer reserves the right to introduce design changes.

I. IMPLANTS	4
I.1. RECONSTRUCTION NAIL	4
II. INTRODUCTION	9
III. INSTRUMENT SET	13
IV. SURGICAL TECHNIQUE.....	15
IV.1. INTRODUCTION	15
IV.2. OPENING THE MEDULLARY CANAL (PROXIMAL INSERTION OF THE HUMERAL NAIL)	15
IV.3. PREPARATION OF THE MEDULLARY CANAL.....	16
IV.4. ASSEMBLING THE COMPRESSION HUMERAL NAIL. POSITIONING TARGETER B. INSERTION OF THE NAIL INTO MEDULLARY CANAL	17
IV.5. DISTAL LOCKING OF THE NAIL.....	18
IV.6. PROXIMAL LOCKING OF THE NAIL	21
<i>IV.6.1. Dynamic method and dynamic with compression (compressive).....</i>	<i>21</i>
IV.7. STATIC METHOD.....	23
IV.8. OBLIQUE LOCKING OF THE NAIL.....	25
IV.9. HUMERAL NAIL REMOVAL FROM THE TARGETER	27
IV.10. PROXIMAL LOCKING OF A SHORT RECONSTRUCTION HUMERAL NAIL.....	28
IV.11. DISTAL LOCKING OF A SHORT RECONSTRUCTION HUMERAL NAIL	32
IV.12. DISTAL LOCKING OF A LONG RECONSTRUCTION HUMERAL NAIL	35
IV.13. PROXIMAL LOCKING OF LONG RECONSTRUCTION HUMERAL NAIL	39
IV.14. DISTAL LOCKING OF THE NAIL BY "FREEHAND" TECHNIQUE	43
IV.15. NAIL EXTRACTION	44
IV.16. DISTAL NAIL INSERTION INTO THE MEDULLARY CANAL	45

I. IMPLANTS

I.1. RECONSTRUCTION NAIL

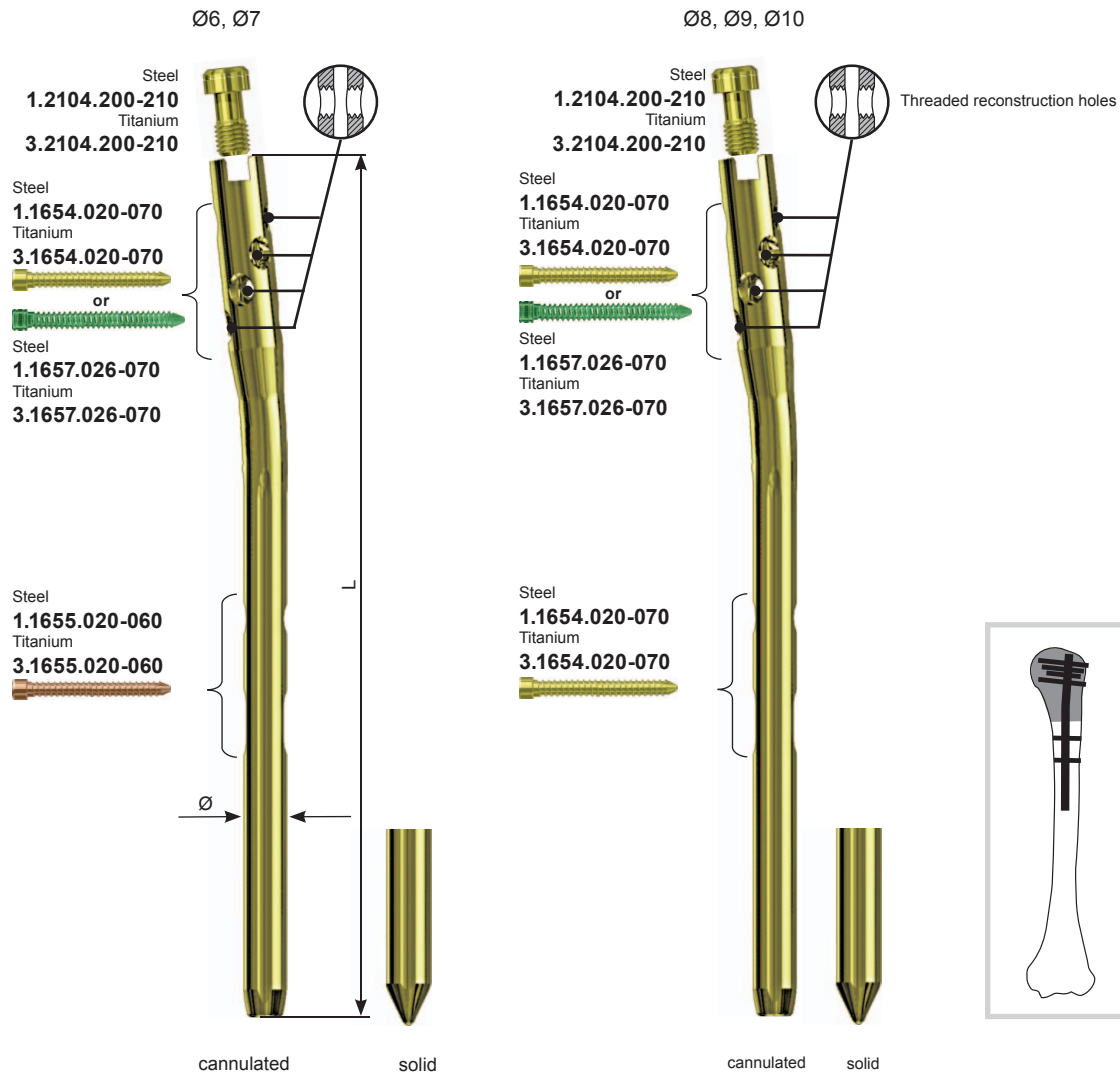

L [mm]		Ø	Steel	Titanium
150		6	1.2430.150	3.2430.150
150	7		1.2432.150	3.2432.150
	8		1.2434.150	3.2434.150
	9		1.2436.150	3.2436.150

L [mm]		Ø	Steel	Titanium
150		6	1.2450.150	3.2450.150
150	7		1.2452.150	3.2452.150
	8		1.2454.150	3.2454.150
	9		1.2456.150	3.2456.150

available

Ø [mm] pitch 1 mm	6÷10	6÷10
L [mm] pitch 5 mm	150÷200	150÷200

RECONSTRUCTION HUMERAL NAIL LONG

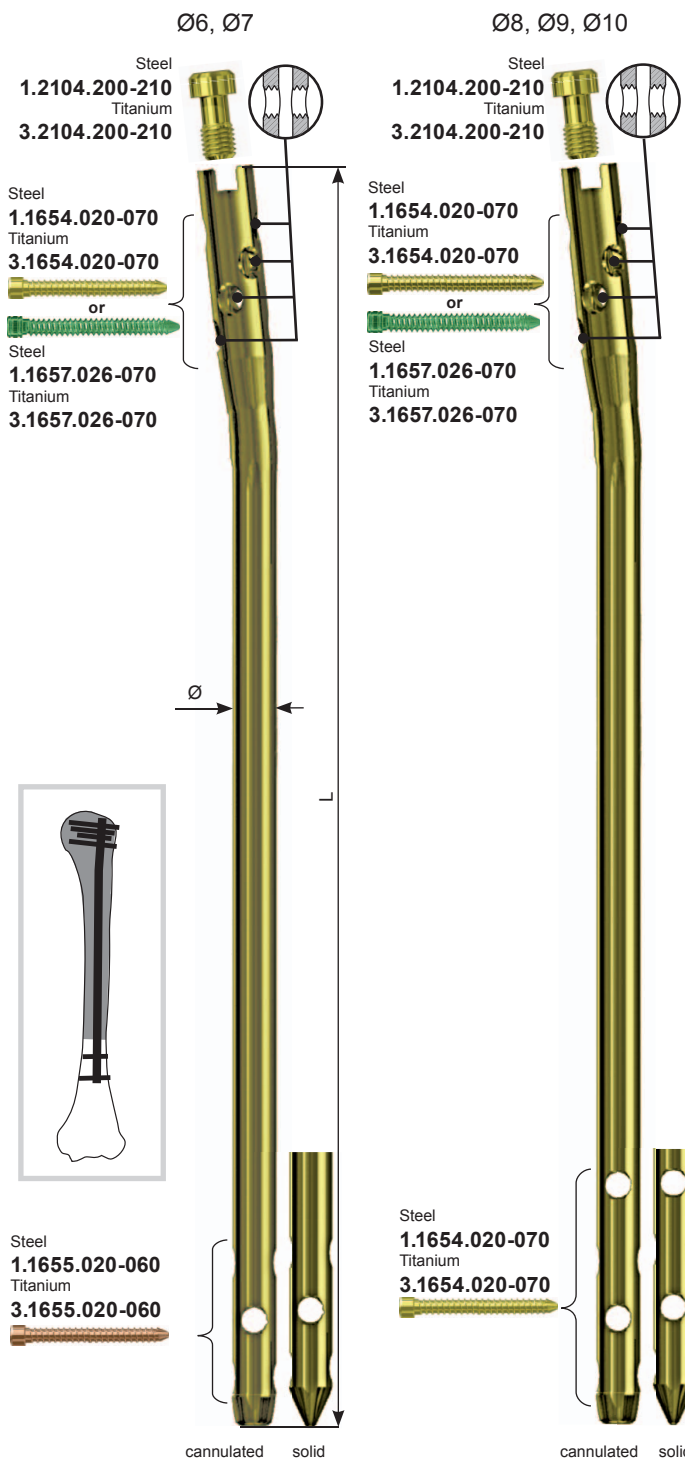

L [mm]	Ø	Ø6		Ø7	
		Steel	Titanium	Steel	Titanium
200	6	1.2431.200	3.2431.200	200	1.2451.200
220		1.2431.220	3.2431.220	220	1.2451.220
240		1.2431.240	3.2431.240	240	1.2451.240
260		1.2431.260	3.2431.260	260	1.2451.260
280		1.2431.280	3.2431.280	280	1.2451.280
300		1.2431.300	3.2431.300	300	1.2451.300
320		1.2431.320	3.2431.320	320	1.2451.320

L [mm]	Ø	Ø8		Ø9		Ø10		
		Steel	Titanium	Steel	Titanium	Steel	Titanium	
200	7	1.2433.200	3.2433.200	200	1.2453.200	3.2453.200	200	1.2453.200
220		1.2433.220	3.2433.220	220	1.2453.220	3.2453.220	220	1.2453.220
240		1.2433.240	3.2433.240	240	1.2453.240	3.2453.240	240	1.2453.240
260		1.2433.260	3.2433.260	260	1.2453.260	3.2453.260	260	1.2453.260
280		1.2433.280	3.2433.280	280	1.2453.280	3.2453.280	280	1.2453.280
300		1.2433.300	3.2433.300	300	1.2453.300	3.2453.300	300	1.2453.300
320		1.2433.320	3.2433.320	320	1.2453.320	3.2453.320	320	1.2453.320
200		8	1.2435.200	3.2435.200	200	1.2455.200	3.2455.200	200
220	1.2435.220		3.2435.220	220	1.2455.220	3.2455.220	220	1.2455.220
240	1.2435.240		3.2435.240	240	1.2455.240	3.2455.240	240	1.2455.240
260	1.2435.260		3.2435.260	260	1.2455.260	3.2455.260	260	1.2455.260
280	1.2435.280		3.2435.280	280	1.2455.280	3.2455.280	280	1.2455.280
300	1.2435.300		3.2435.300	300	1.2455.300	3.2455.300	300	1.2455.300
320	1.2435.320		3.2435.320	320	1.2455.320	3.2455.320	320	1.2455.320
200	9		1.2437.200	3.2437.200	200	1.2457.200	3.2457.200	200
220		1.2437.220	3.2437.220	220	1.2457.220	3.2457.220	220	1.2457.220
240		1.2437.240	3.2437.240	240	1.2457.240	3.2457.240	240	1.2457.240
260		1.2437.260	3.2437.260	260	1.2457.260	3.2457.260	260	1.2457.260
280		1.2437.280	3.2437.280	280	1.2457.280	3.2457.280	280	1.2457.280
300		1.2437.300	3.2437.300	300	1.2457.300	3.2457.300	300	1.2457.300
320		1.2437.320	3.2437.320	320	1.2457.320	3.2457.320	320	1.2457.320

available

	Ø6, Ø7	Ø8, Ø9, Ø10
Ø [mm] pitch 1 mm	6+10	6+10
L [mm] pitch 5 mm	200+400	200+400

LOCKING ELEMENTS

End cap M7x1

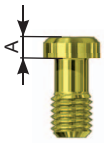

Catalogue no.		
A	Steel	Titanium
0	1.2104.200	3.2104.200
+5	1.2104.205	3.2104.205
+10	1.2104.210	3.2104.210

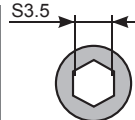

Distal screw Ø4.5

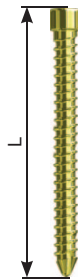

Catalogue no.		
L [mm]	Steel	Titanium
20	1.1654.020	3.1654.020
22	1.1654.022	3.1654.022
24	1.1654.024	3.1654.024
26	1.1654.026	3.1654.026
28	1.1654.028	3.1654.028
30	1.1654.030	3.1654.030
35	1.1654.035	3.1654.035
40	1.1654.040	3.1654.040
45	1.1654.045	3.1654.045
50	1.1654.050	3.1654.050
55	1.1654.055	3.1654.055
60	1.1654.060	3.1654.060
65	1.1654.065	3.1654.065
70	1.1654.070	3.1654.070

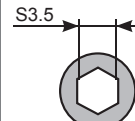

Distal screw Ø3.5

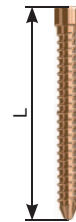

Catalogue no.		
L [mm]	Steel	Titanium
20	1.1655.020	3.1655.020
22	1.1655.022	3.1655.022
24	1.1655.024	3.1655.024
26	1.1655.026	3.1655.026
28	1.1655.028	3.1655.028
30	1.1655.030	3.1655.030
35	1.1655.035	3.1655.035
40	1.1655.040	3.1655.040
45	1.1655.045	3.1655.045
50	1.1655.050	3.1655.050
55	1.1655.055	3.1655.055
60	1.1655.060	3.1655.060

available

L [mm]	16 ÷ 70
--------	---------

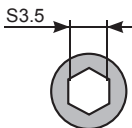

Distal screw Ø5.0

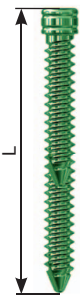

Catalogue no.		
L [mm]	Steel	Titanium
26	1.1657.026	3.1657.026
28	1.1657.028	3.1657.028
30	1.1657.030	3.1657.030
35	1.1657.035	3.1657.035
40	1.1657.040	3.1657.040
45	1.1657.045	3.1657.045
50	1.1657.050	3.1657.050
55	1.1657.055	3.1657.055
60	1.1657.060	3.1657.060
65	1.1657.065	3.1657.065
70	1.1657.070	3.1657.070

available

L [mm]	16 ÷ 100
--------	----------

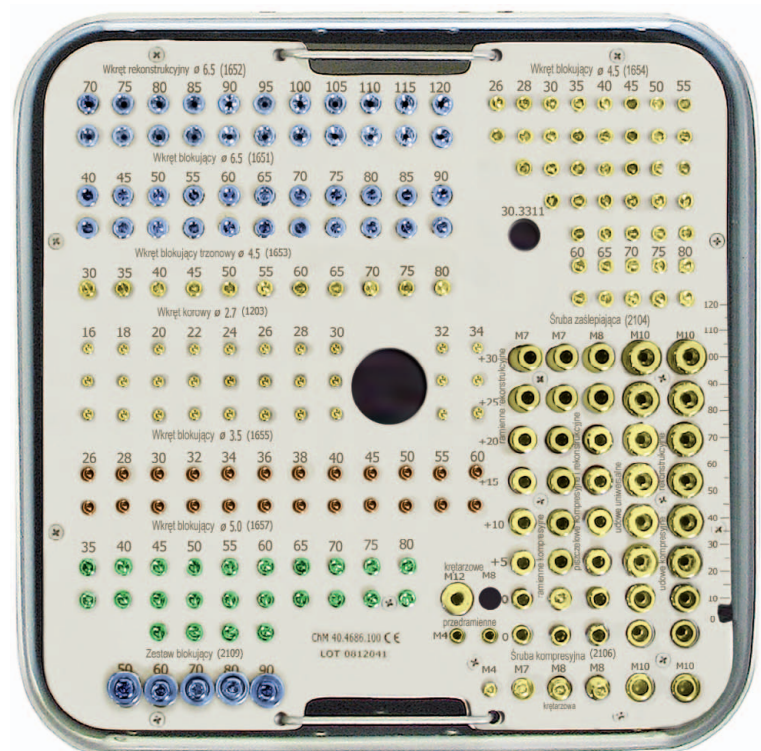

40.4686.000
Stand for nails' locking elements
(set with a box without implants)

COMPRESSION HUMERAL NAIL

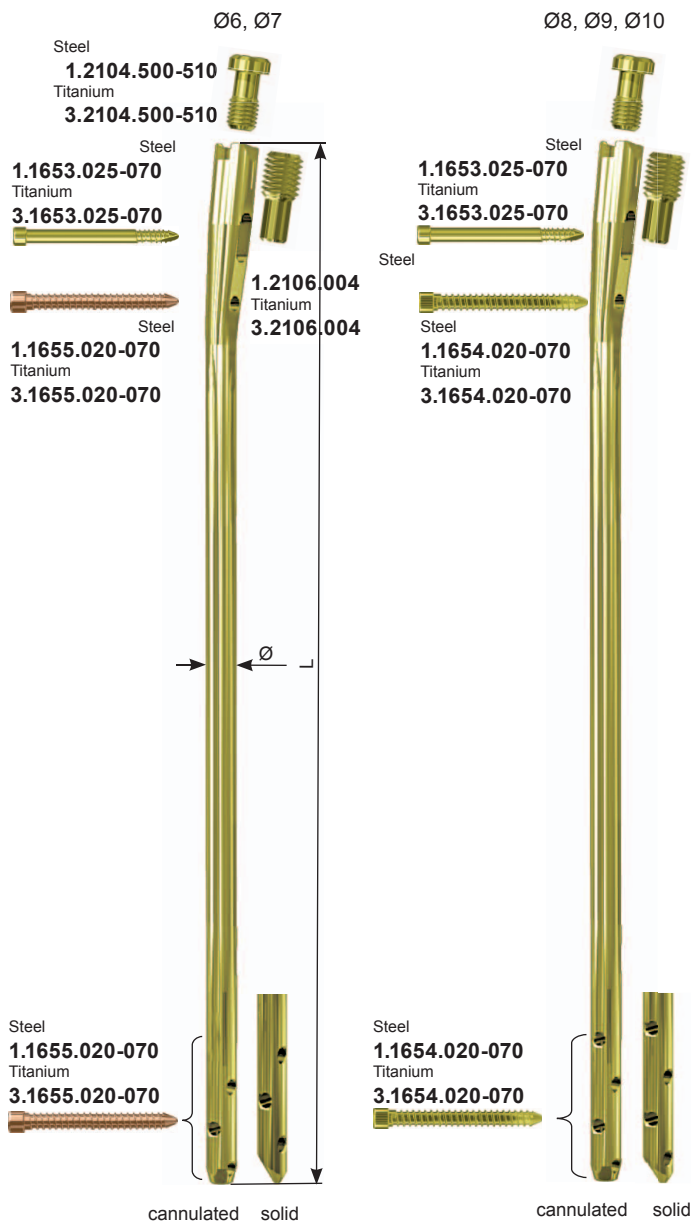

L [mm]	Ø	Ø6		Ø7		Ø8		Ø9		Ø10	
		Steel	Titanium	Steel	Titanium	Steel	Titanium	Steel	Titanium	Steel	Titanium
180	6	1.2383.180	3.2383.180	1.2099.180	3.2099.180	1.2096.180	3.2096.180	1.2098.180	3.2098.180	1.2098.180	3.2098.180
200		1.2383.200	3.2383.200	1.2099.200	3.2099.200	1.2096.200	3.2096.200	1.2098.200	3.2098.200	1.2098.200	3.2098.200
220		1.2383.220	3.2383.220	1.2099.220	3.2099.220	1.2096.220	3.2096.220	1.2098.220	3.2098.220	1.2098.220	3.2098.220
240		1.2383.240	3.2383.240	1.2099.240	3.2099.240	1.2096.240	3.2096.240	1.2098.240	3.2098.240	1.2098.240	3.2098.240
260		1.2383.260	3.2383.260	1.2099.260	3.2099.260	1.2096.260	3.2096.260	1.2098.260	3.2098.260	1.2098.260	3.2098.260
280		1.2383.280	3.2383.280	1.2099.280	3.2099.280	1.2096.280	3.2096.280	1.2098.280	3.2098.280	1.2098.280	3.2098.280
300		1.2383.300	3.2383.300	1.2099.300	3.2099.300	1.2096.300	3.2096.300	1.2098.300	3.2098.300	1.2098.300	3.2098.300
320	1.2383.320	3.2383.320	1.2099.320	3.2099.320	1.2096.320	3.2096.320	1.2098.320	3.2098.320	1.2098.320	3.2098.320	
180	7	1.2384.180	3.2384.180	1.2100.180	3.2100.180	1.2097.180	3.2097.180	1.2098.180	3.2098.180	1.2098.180	3.2098.180
200		1.2384.200	3.2384.200	1.2100.200	3.2100.200	1.2097.200	3.2097.200	1.2098.200	3.2098.200	1.2098.200	3.2098.200
220		1.2384.220	3.2384.220	1.2100.220	3.2100.220	1.2097.220	3.2097.220	1.2098.220	3.2098.220	1.2098.220	3.2098.220
240		1.2384.240	3.2384.240	1.2100.240	3.2100.240	1.2097.240	3.2097.240	1.2098.240	3.2098.240	1.2098.240	3.2098.240
260		1.2384.260	3.2384.260	1.2100.260	3.2100.260	1.2097.260	3.2097.260	1.2098.260	3.2098.260	1.2098.260	3.2098.260
280		1.2384.280	3.2384.280	1.2100.280	3.2100.280	1.2097.280	3.2097.280	1.2098.280	3.2098.280	1.2098.280	3.2098.280
300		1.2384.300	3.2384.300	1.2100.300	3.2100.300	1.2097.300	3.2097.300	1.2098.300	3.2098.300	1.2098.300	3.2098.300
320	1.2384.320	3.2384.320	1.2100.320	3.2100.320	1.2097.320	3.2097.320	1.2098.320	3.2098.320	1.2098.320	3.2098.320	
180	8	1.2095.180	3.2095.180	1.2097.180	3.2097.180	1.2096.180	3.2096.180	1.2098.180	3.2098.180	1.2098.180	3.2098.180
200		1.2095.200	3.2095.200	1.2097.200	3.2097.200	1.2096.200	3.2096.200	1.2098.200	3.2098.200	1.2098.200	3.2098.200
220		1.2095.220	3.2095.220	1.2097.220	3.2097.220	1.2096.220	3.2096.220	1.2098.220	3.2098.220	1.2098.220	3.2098.220
240		1.2095.240	3.2095.240	1.2097.240	3.2097.240	1.2096.240	3.2096.240	1.2098.240	3.2098.240	1.2098.240	3.2098.240
260		1.2095.260	3.2095.260	1.2097.260	3.2097.260	1.2096.260	3.2096.260	1.2098.260	3.2098.260	1.2098.260	3.2098.260
280		1.2095.280	3.2095.280	1.2097.280	3.2097.280	1.2096.280	3.2096.280	1.2098.280	3.2098.280	1.2098.280	3.2098.280
300		1.2095.300	3.2095.300	1.2097.300	3.2097.300	1.2096.300	3.2096.300	1.2098.300	3.2098.300	1.2098.300	3.2098.300
320	1.2095.320	3.2095.320	1.2097.320	3.2097.320	1.2096.320	3.2096.320	1.2098.320	3.2098.320	1.2098.320	3.2098.320	
180	9	1.2096.180	3.2096.180	1.2098.180	3.2098.180	1.2096.180	3.2096.180	1.2098.180	3.2098.180	1.2098.180	3.2098.180
200		1.2096.200	3.2096.200	1.2098.200	3.2098.200	1.2096.200	3.2096.200	1.2098.200	3.2098.200	1.2098.200	3.2098.200
220		1.2096.220	3.2096.220	1.2098.220	3.2098.220	1.2096.220	3.2096.220	1.2098.220	3.2098.220	1.2098.220	3.2098.220
240		1.2096.240	3.2096.240	1.2098.240	3.2098.240	1.2096.240	3.2096.240	1.2098.240	3.2098.240	1.2098.240	3.2098.240
260		1.2096.260	3.2096.260	1.2098.260	3.2098.260	1.2096.260	3.2096.260	1.2098.260	3.2098.260	1.2098.260	3.2098.260
280		1.2096.280	3.2096.280	1.2098.280	3.2098.280	1.2096.280	3.2096.280	1.2098.280	3.2098.280	1.2098.280	3.2098.280
300		1.2096.300	3.2096.300	1.2098.300	3.2098.300	1.2096.300	3.2096.300	1.2098.300	3.2098.300	1.2098.300	3.2098.300
320	1.2096.320	3.2096.320	1.2098.320	3.2098.320	1.2096.320	3.2096.320	1.2098.320	3.2098.320	1.2098.320	3.2098.320	

available

	Ø6	Ø7	Ø8	Ø9	Ø10
Ø [mm] pitch 1 mm	6÷10	6÷10	6÷10	6÷10	6÷10
L [mm] pitch 5 mm	180÷400	180÷400	180÷400	180÷400	180÷400

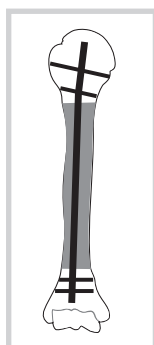

LOCKING ELEMENTS



End cap M7x1

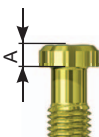

Catalogue no.		
A	Steel	Titanium
0	1.2104.500	3.2104.500
+5	1.2104.505	3.2104.505
+10	1.2104.510	3.2104.510

Compression screw M7x1



Catalogue no.	
Steel	Titanium
1.2106.004	3.2106.004

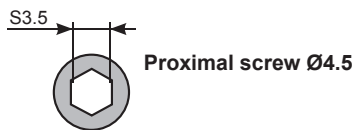

Catalogue no.			
L [mm]	L1 [mm]	Steel	Titanium
25	12	1.1653.025	3.1653.025
30	12	1.1653.030	3.1653.030
35	16	1.1653.035	3.1653.035
40	16	1.1653.040	3.1653.040
45	16	1.1653.045	3.1653.045
50	18	1.1653.050	3.1653.050
55	18	1.1653.055	3.1653.055
60	18	1.1653.060	3.1653.060
65	20	1.1653.065	3.1653.065
70	20	1.1653.070	3.1653.070

available

L [mm]	25 ÷ 90
--------	---------

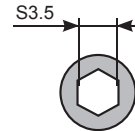

Catalogue no.		
L [mm]	Steel	Titanium
20	1.1654.020	3.1654.020
22	1.1654.022	3.1654.022
24	1.1654.024	3.1654.024
26	1.1654.026	3.1654.026
28	1.1654.028	3.1654.028
30	1.1654.030	3.1654.030
35	1.1654.035	3.1654.035
40	1.1654.040	3.1654.040
45	1.1654.045	3.1654.045
50	1.1654.050	3.1654.050
55	1.1654.055	3.1654.055
60	1.1654.060	3.1654.060
65	1.1654.065	3.1654.065
70	1.1654.070	3.1654.070

available

L [mm]	16 ÷ 100
--------	----------

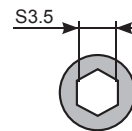

Catalogue no.		
L [mm]	Steel	Titanium
20	1.1655.020	3.1655.020
22	1.1655.022	3.1655.022
24	1.1655.024	3.1655.024
26	1.1655.026	3.1655.026
28	1.1655.028	3.1655.028
30	1.1655.030	3.1655.030
35	1.1655.035	3.1655.035
40	1.1655.040	3.1655.040
45	1.1655.045	3.1655.045
50	1.1655.050	3.1655.050
55	1.1655.055	3.1655.055
60	1.1655.060	3.1655.060
65	1.1655.065	3.1655.065
70	1.1655.070	3.1655.070

available

L [mm]	16 ÷ 70
--------	---------

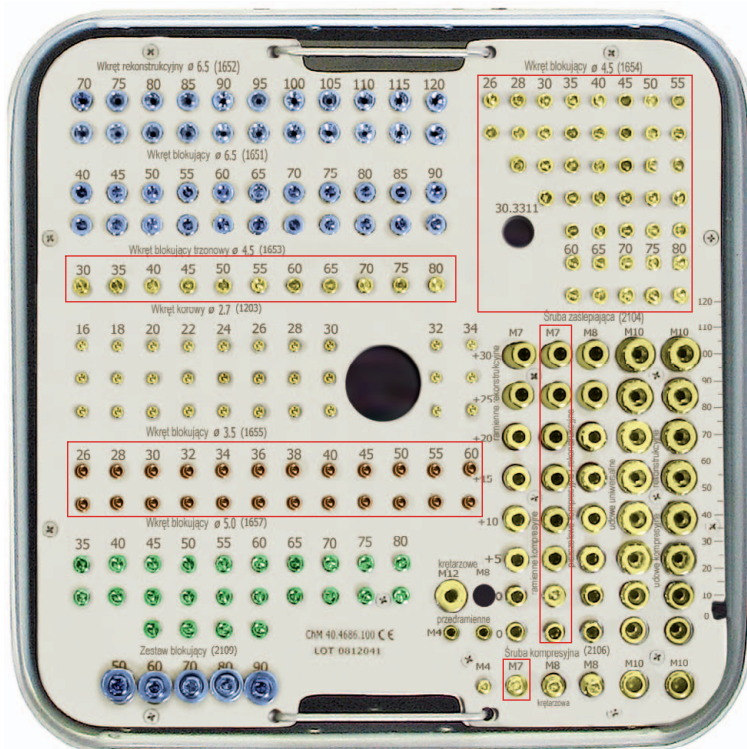

40.4686.000
Stand for nails' locking elements
(set with a box without implants)

II. INTRODUCTION

CHARFIX^{system}

- INTRAMEDULLARY OSTEOSYNTHESIS OF HUMERUS, consists of:

- Implants (*intramedullary nail, locking screws, end cap or compression screw*),
- Instrument set for implant insertion and removal when the treatment has been completed,
- Instructions for use (*surgical technique*).

Intramedullary osteosynthesis of humerus provides stable fixation in the following cases:

- comminuted fractures of the shaft of the humerus,
- Severe closed and open fractures of I degree,
- pathological fractures, mal-union or non-union of the fragments of the humeral shaft after treatment using other methods.

CHARFIX^{system} provides the following methods of intramedullary fixation:

Static Method

Static fixation is used in multi-fragmental fractures with non-axial stability of bone fragments.

Use holes in the distal part of the nail, and one round or both holes - round and oval-shaped - in the proximal part to lock the nail statically.



Dynamic Method

Dynamic fixation may be used in the case of good cortex contact of bone fragments in transverse and oblique fractures, as well as in false joints. All distal holes and one oval-shaped proximal hole of the intramedullary humeral nail are used in that fixation.

Dynamic fixation enables axial movement of bone fragments while loading the limb. In this way, a physiological stimulus is formed to create bone scar and its reconstruction into the lamellar bone.



Dynamic Method with Compression

In dynamic fixation with compression (*compressive fixation*) the compression screw shall be axially inserted into internal threaded hole of the nail shaft in order to put pressure on the screw that locks the nail. The compressive fixation eliminates all micro-movements in the initial stage of fracture treatment.



Oblique locking of the nail

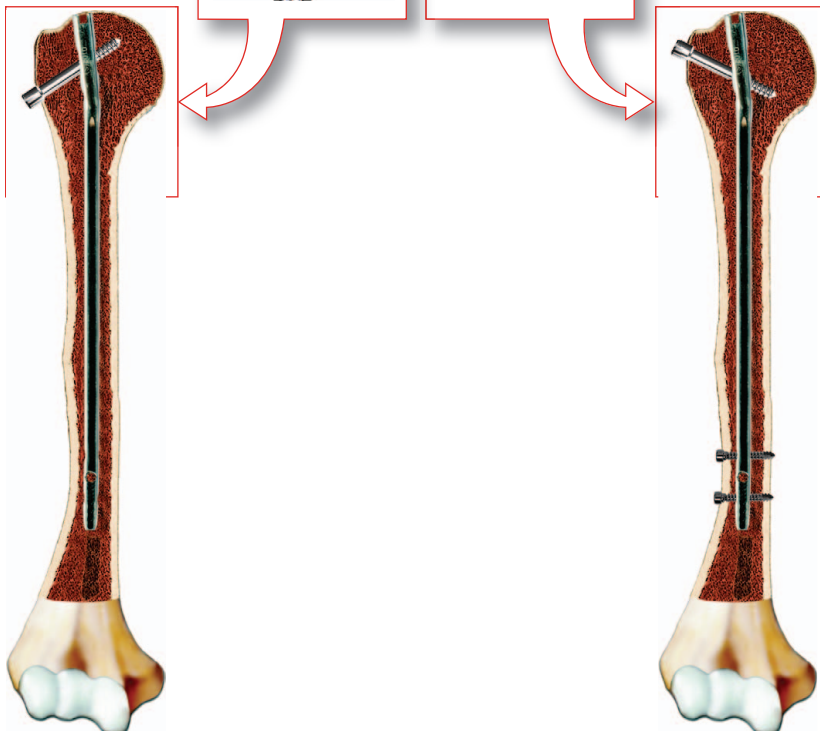
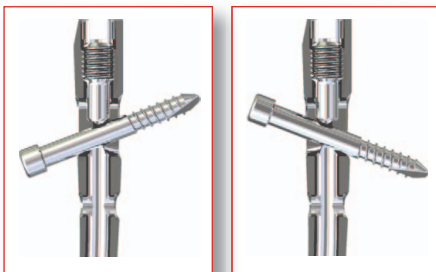

Distal insertion of the nail

Humeral bone fractures located in the shaft, metaphysis and epiphysis of humeral bone may be also reduced using intramedullary ChM nail inserted from the distal epiphysis area.

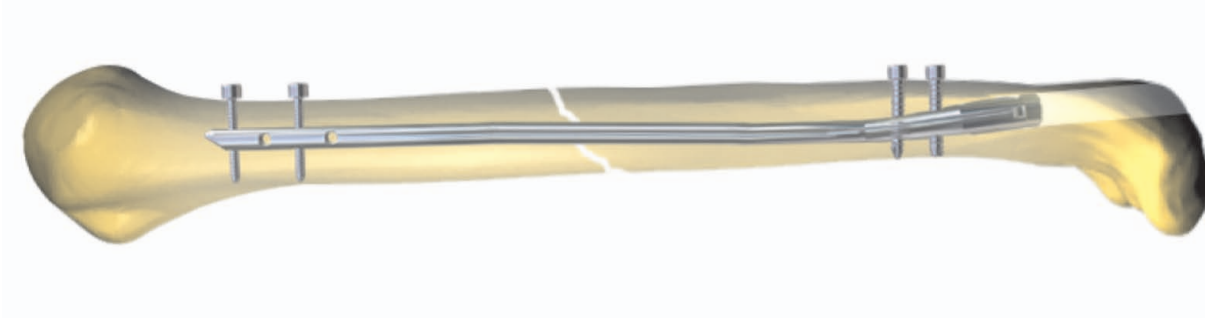
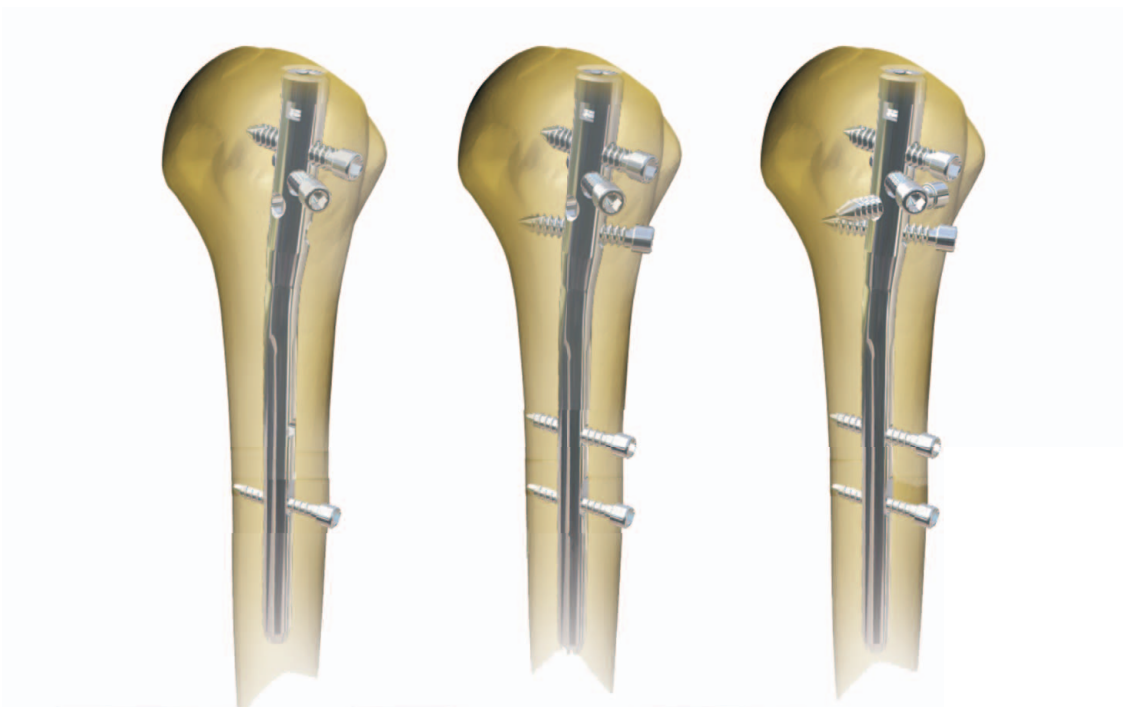
**Exemplary versions of locking the reconstruction humeral nail:**

Reconstruction intramedullary humeral nail comes with:

- diameter range: from 6 to 14mm (*graded every 1mm*);
- solid and cannulated version;
- length range: short version - 150 to 215mm and long version 220 to 400mm;
- made of stainless steel and titanium alloy.

Nail design enables implantation in right and left limb. Nails in short and long version can be used with the same targeter. Locking the short nails in its distal part shall be performed with use of targeter holes marked as RECONSTRUCTION, wherein the long nails shall be locked with use of slider located on targeter (*before implantation, slider shall be placed in a way to enable set blocks freely pass the slider holes and then hit the nail holes*), or using "free hand" technique. There are 4 holes in the proximal part of the nail to reduce damaged fragments of the humerus head. Threaded locking holes in the reconstruction humeral nail allow for optional locking with use of:

- proximal screw 4.5

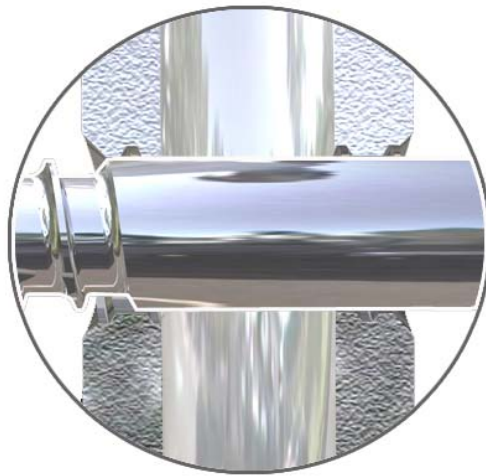



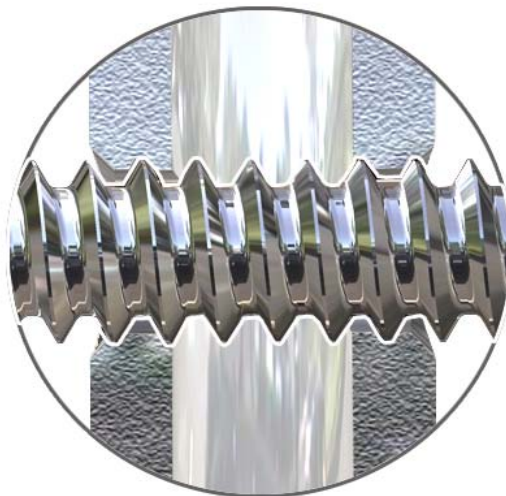



















- locking screw 5.0, which by anchoring in the nail prevents angle displacement and movement of the fractured bone fragments (*using threaded hole in the nail*).





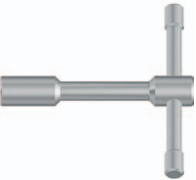





III. INSTRUMENT SET

The fixation of the humeral shaft fracture, and implants removal after finished treatment are carried out with the Instrument Set [40.5020.500]. All instruments are placed in the stand with a lid which enables storage and transportation to the operating suite. The instrument set consists of the following instruments:

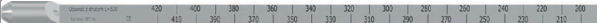
40.5020.500

No.		Name	Catalogue No.	Pcs
1		Humeral targeter B	40.5030.000	1
2		Distal targeter D	40.5010.000	1
3		Angular targeter	40.5024.000	1
4		Connecting screw M7x1spec. L=101	40.5023.000	1
5		Connecting screw M7x1spec. L=95	40.5023.100	1
6		Set block	40.3644.000	2
7		Protective guide 9/6.5	40.3645.100	2
8		Drill guide 6.5/3.5	40.3646.100	2
9		Drill guide 6.5/2.8	40.3661.100	2
10		Drill guide 6.5/4.5	40.3697.100	1
11		Trocar 6.5	40.3647.000	1
12		Targeter D	40.1344.000	1
13		Trocar short 7	40.1354.000	1
14		Drill guide short 7/3.5	40.1358.000	1
15		Drill guide 7/2.8	40.3670.000	1
16		Impactor-extractor	40.3665.000	1
17		Mallet	40.3667.000	1
18		Connector M7/M16	40.4751.000	1
19		Hexagonal screwdriver 3.5	40.5031.000	1
20		Socket wrench S11	40.3648.000	1
21		Screw length measure	40.3698.100	1
22		Guide rod 1.8/500	40.5025.000	1
23		Guide rod handle	40.1351.000	1

No.		Name	Catalogue No.	Pcs
24		Teflon pipe guide 7/290	40.3699.000	1
25		Drill with scale 2.8/240	40.5332.001	2
26		Drill with scale 3.5/240	40.5331.001	2
27		Drill with scale 4.5/240	40.5336.001	1
28		Nail length measure	40.4799.000	1
29		Aiming insert 9.0	40.5065.009	4
30		Curved awl 8,0	40.5523.000	1
31		Stand	40.4492.500	1

To carry out the surgery some necessary basic devices are needed:

- electric drive,
- set of flexible intramedullary reamers in diameters between 6.0 and 11.0 mm with guide and handle,
- set of awls (*standard and cannulated*),
- set of surgical drills,
- Kirchner wires,
- hammers,
- and others.

IV. SURGICAL TECHNIQUE

IV.1. INTRODUCTION

X-Ray of humeral fracture in AP and lateral position shall be performed before starting the operation in order to define the fracture type and the nail size (*length, diameter*). Sometimes X-Ray of opposite healthy humerus shall be performed. The operation shall be performed on the operating table equipped with traction and image intensifier with patient placed supine or on the healthy side (*depends on surgeon*), on the edge of the table with radiolucent base under the arm. The intramedullary nail can be inserted into medullary canal as follows:

- proximally (*from humeral joint side*),
- distally (*from distal part of bone shaft*).

The surgical approach of proximal intramedullary nail insertion shall be prepared by:

- 2-3 cm skin incision, starting from clavicle-shoulder joint in anterior-lateral direction, parallel to the fibers of deltoid muscle,
- splitting fibers of deltoid muscle,
- exposing supraspinous muscle attachment and his slight splitting.

IV.2. OPENING THE MEDULLARY CANAL (*PROXIMAL INSERTION OF THE HUMERAL NAIL*)

1 After preparing the surgical approach (*as described in IV.1. chapter of Surgical technique*) in order to open the medullary canal use the electric drive to insert the Kirschner wire (*Kirschner wire 2/310mm recommended*) a little bit medially, to the greater tuberculum, in the axis of medullary canal.

This step must be performed under X-Ray camera with video channel control.

The Kirchner wire acts as a guide for the cannulated awl.
The Kirchner wire is a single use instrument.

2 Insert the Cannulated Awl via the Kirschner wire to open the medullary canal in depth for approx. 7 cm.

Remove the Awl and Kirchner Wire.



It is recommended to open medullary canal with technique described in steps 1 and 2. The surgeon can use other technique that depends on equipment of the operation suite.

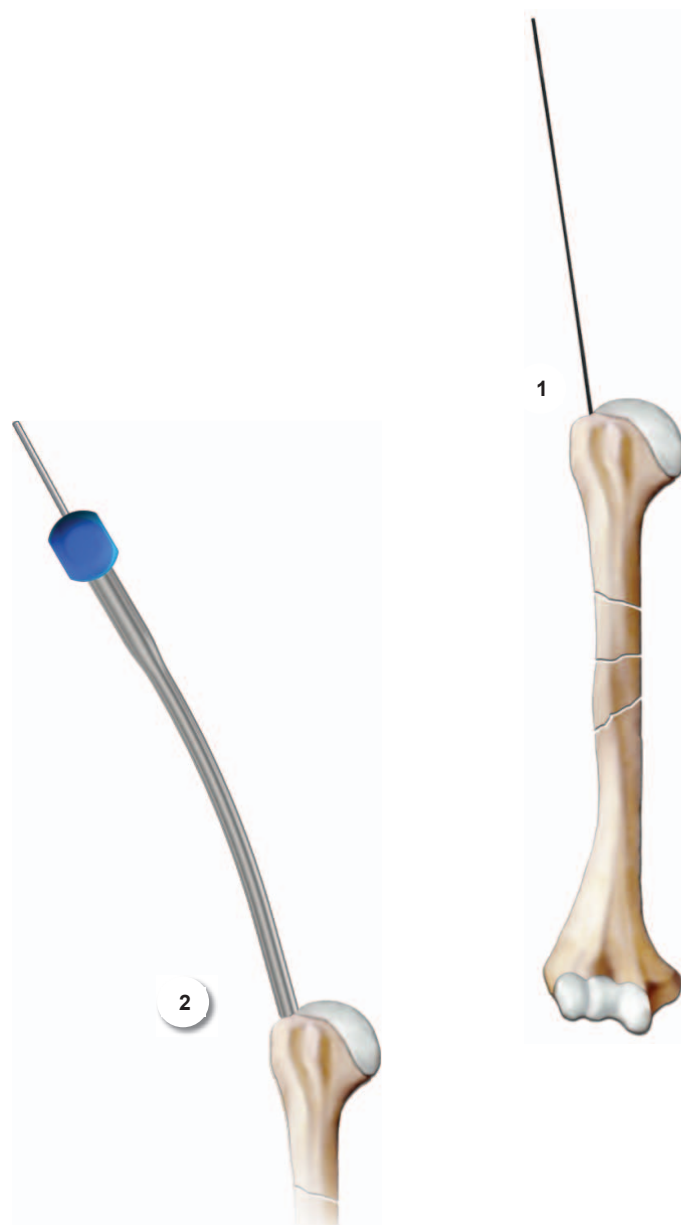

IV.3. PREPARATION OF THE MEDULLARY CANAL

Reamed canal

3 Insert the Guide Rod 1.8/500 [40.5025] into the medullary canal to the appropriate depth, reducing the fracture at the same time. Gradually widen the medullary canal with flexible reamers with 0.5 mm increments, until the diameter 0.5 mm wider than the diameter of the humeral nail, for the depth not lesser than the nail length, is reached.

The proximal part of the medullary canal should be reamed to the diameter of 11mm, to the depth of approx. 7cm. (proximal part of the nail is wider than its distal part).

Remove the Flexible Reamer.

Leave the Guide Rod 1.8/500 [40.5025].

4 Insert the Nail Length Measure [40.4799] onto the Guide Rod 1.8/500 [40.5025] until it reaches the bone. The end of the Guide Rod indicates the implant length.

5 In case of using solid nail, remove the Guide Rod 1.8/500 [40.5025] from the medullary canal using the Guide rod handle [40.1351].

The medullary canal is prepared for the humeral nail insertion.

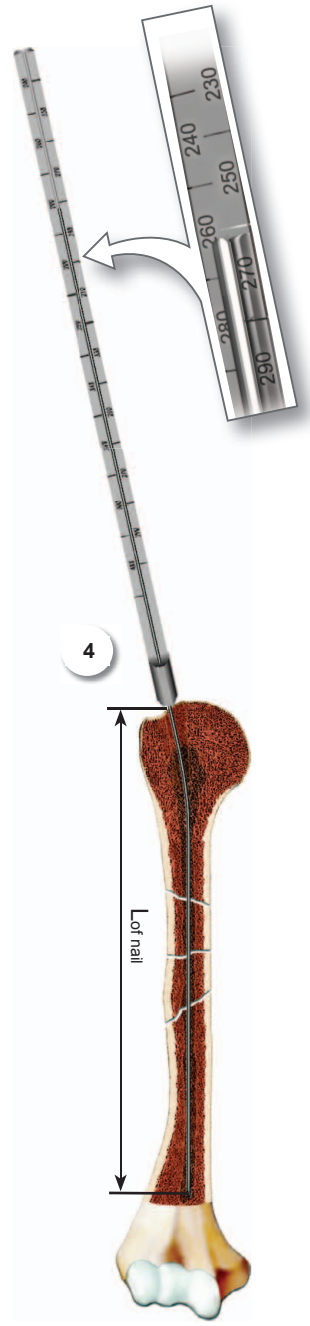
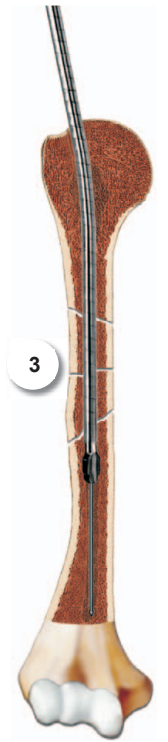

IV.4. ASSEMBLING THE COMPRESSION HUMERAL NAIL. POSITIONING TARGETER B. INSERTION OF THE NAIL INTO MEDULLARY CANAL

6 Using the Socket Wrench S 11 [40.3648] and the Connecting Screw [40.5023.000] mount the intramedullary nail to the Humeral targeter B [40.5030]. The Humeral targeter B [40.5030] and the Targeter D [40.5010] are instruments used with compression and reconstruction humeral nails. There are several holes in its proximal part that enable nail locking. The holes on targeter are described as follows:

- **STAT** – to enable insertion of a locking screw in the round hole in a compression nail,
- **COMPRESSION** – to enable insertion of a locking screw in the oval hole in compression nail,
- **ANGULAR** – to enable oblique insertion of a locking screw in the oval hole in compression nail,
- **RECONSTRUCTION** – to enable locking of a short reconstruction nail in its distal part.

In order to eliminate failure insertion of locking screw, it is recommended to use the Set Blocks [40.3644] and to insert them in the holes in the targeter to control the overlapping of the holes in the Targeter and in the nail. It is also recommended to close the remaining holes with the Aiming inserts [40.5065.009].



Properly installed nail shall be positioned parallel to the arm of Targeter B.

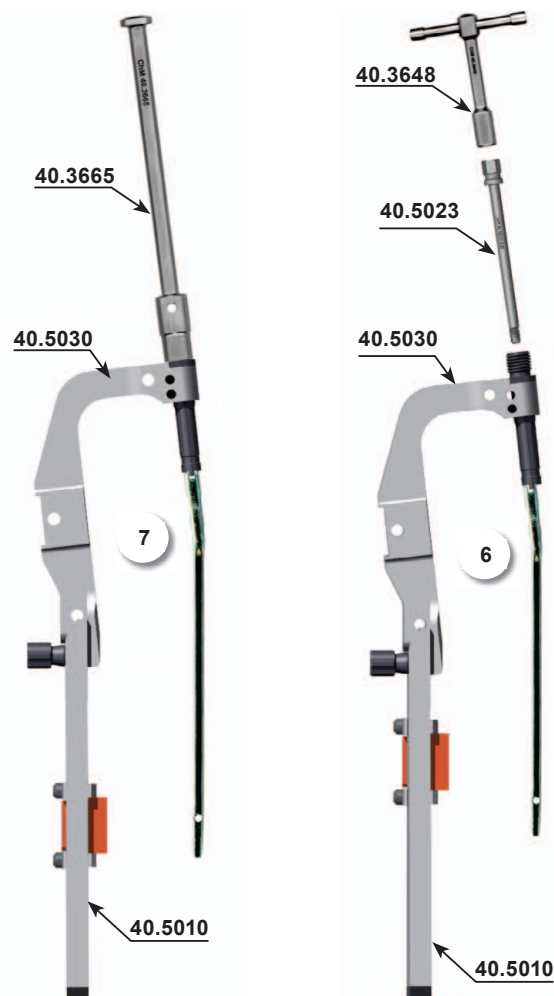

7 Connect the Impactor – Extractor [40.3665] to the assembled system (*attach on the threaded tip of the the Humeral targeter B sleeve [40.5030]*).

8 Using two Set Blocks [40.3644] place the slider of Targeter B in line with distal locking holes of intramedullary nail. Lock the slider of the targeter using the Screwdriver [40.5031].



CHECK:
Properly set and secured slider enables the Set Blocks to smoothly hit the nail hole.

Remove the Set Blocks from the targeter.

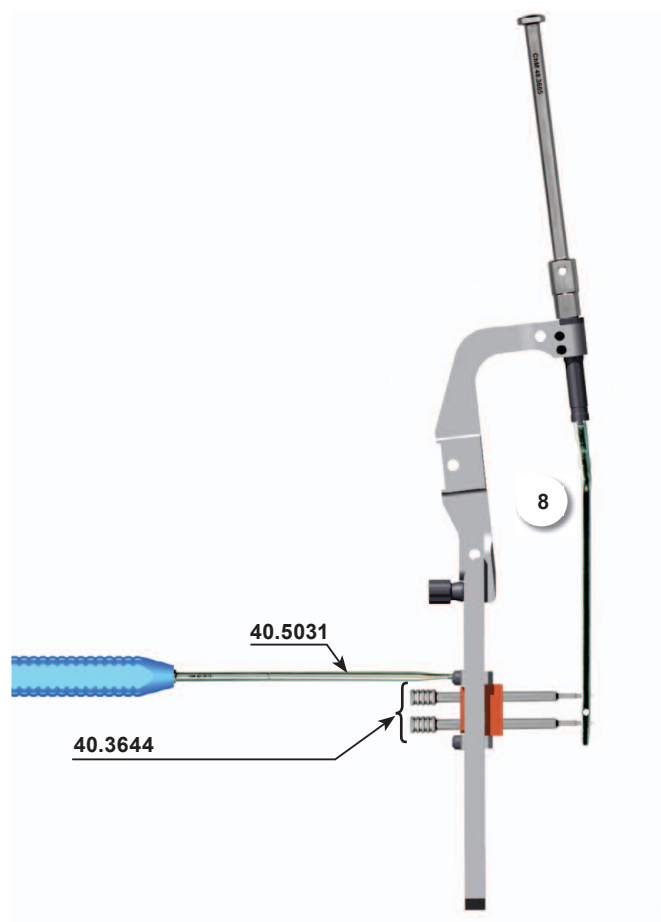

- 9 Insert the humeral nail into the medullary canal to the correct depth using the Mallet [40.3667].



The cannulated nail shall be inserted into the humeral medullary canal via the Guide Rod [40.5025]. The solid nail is inserted directly into the humeral medullary canal (without using the Guide Rod).

Dismount the Impactor-Extractor from the Guide.
Remove the Guide Rod (only when cannulated nail is used for the implantation).

IV.5. DISTAL LOCKING OF THE NAIL

- 10 Before starting distal locking of the nail: verify with X-Ray image intensifier and the Aiming inserts [40.5065.009] the mutual position of holes in the slider of the targeter and distal holes of the intramedullary nail.

The holes in the nail and the slider have to be in line.

Insert the Protective Guide [40.3645.100] with the Trocar 6.5 [40.3647] first into the proximal and then in the distal hole of the slider of the Targeter B and mark on the skin the entry point for insertion of the locking screw. Next make 1.5 cm long incision through the soft tissues.

- 11 Insert the Protective Guide [40.3645.100] with the Trocar 6.5 [40.3647] into the hole in the slider of the Targeter B and advance into prepared incision until it reaches the cortex bone. Using the Trocar mark the entry point for the locking screw.

Remove the Trocar.
Leave the Protective Guide in the slider hole.

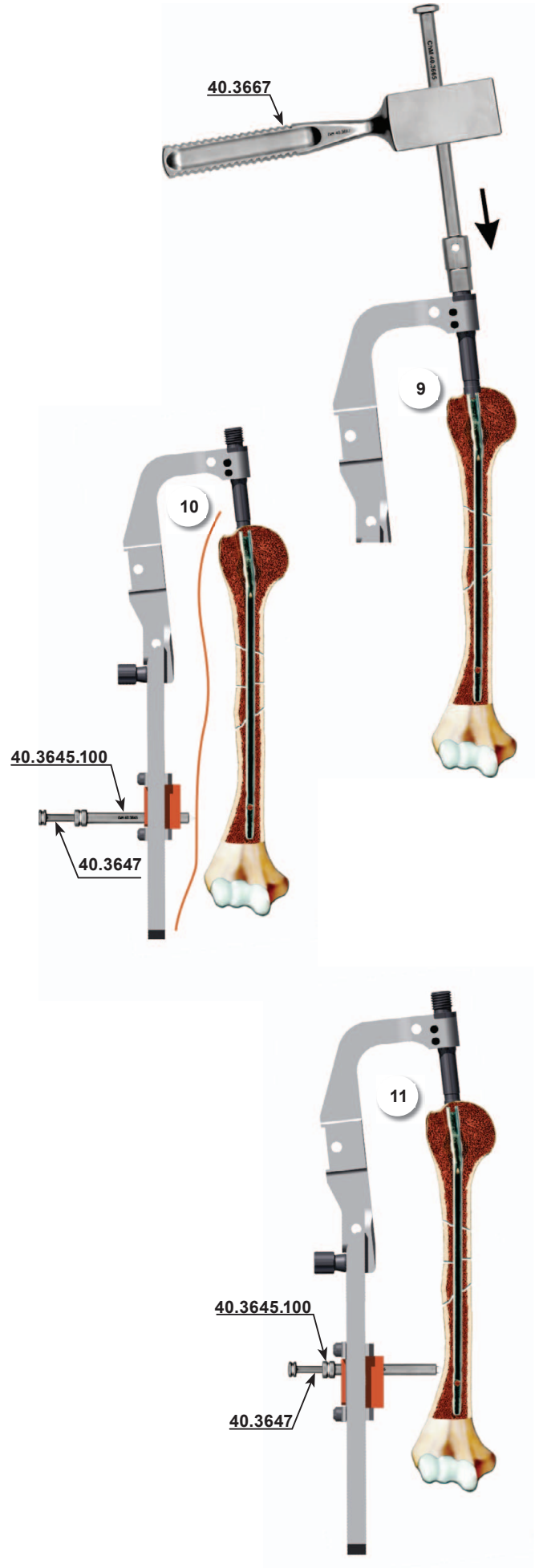

- 12 Drill the hole in the humeral bone for locking screw insertion.

OPTION I

Implantation of 8 or 9mm nails (with use of 4.5 screws).

Insert the Drill Guide 6.5/3.5 [40.3646.100] into the Protective Guide 9.0/6.5 [40.3645.100]. Mount the Drill With Scale 3.5/240 [40.5331.001] on the surgical drive and advance such system through the Drill Guide 6.5/3.5 [40.3646.100]. Drill the hole in the humerus through both cortex layers under the X-Ray control. The scale on the Drill indicates length of locking element.

OPTION II

Implantation of 6 or 7mm nails (with use of 3.5 screws).

Insert the Drill Guide 6.5/2.8 [40.3661.100] into the Protective Guide 9.0/6.5 [40.3645.100]. Mount the Drill With Scale 2.8/240 [40.5332.001] on the surgical drive and advance such system through the Drill Guide 6.5/2.8 [40.3661.100]. Drill the hole in the humerus through both cortex layers under the X-Ray control. The scale on the Drill indicates length of locking element.

Disconnect the Surgical Drive and the Drill.

Leave in place the following system: Protective Guide - Drill Guide - Drill.

OPTION I [40.3645.100] - [40.3646.100] - [40.5331.001]

OPTION II [40.3645.100] - [40.3661.100] - [40.5332.001]

- 13 Mark the entry point for the second locking screw insertion. Repeat step 11.

- 14 Make the canal in the bone for the second locking screw insertion. Repeat step 12. Remove the Drill [40.5331.001] or [40.5332.001] and the Drill Guide [40.3646.100] or [40.3661.100] just after reaming the canal.

Leave the Protective Guide in the hole of the targeter slider.

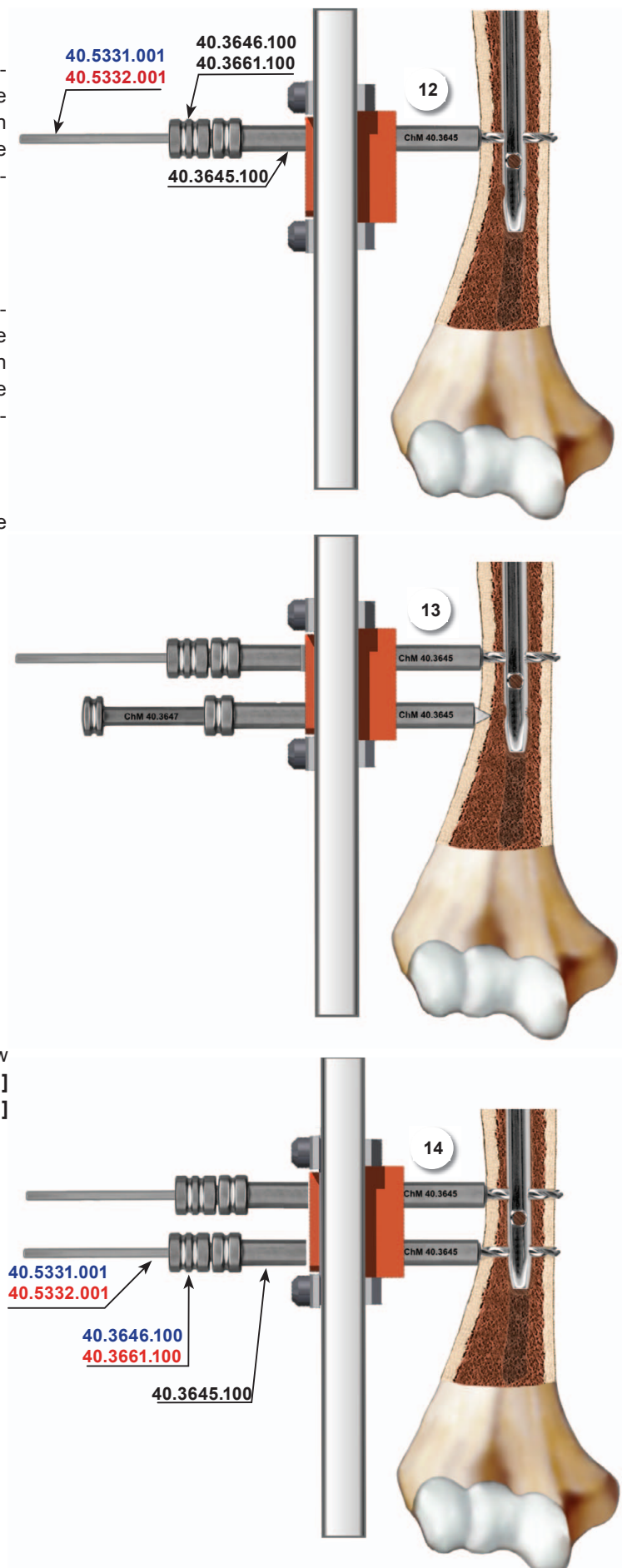

- 15 Insert the Screw Length Measure [40.3698.100] through the Protective Guide [40.3645.100] until its hook reaches the cortex on the other side of the bone. Read the length of the locking screw on the B-D scale.

During the measurement the end of the Protective Guide should rest on the cortex bone.

Remove the Screw Length Measure.
Leave the Protective Guide in the hole of targeter slider.

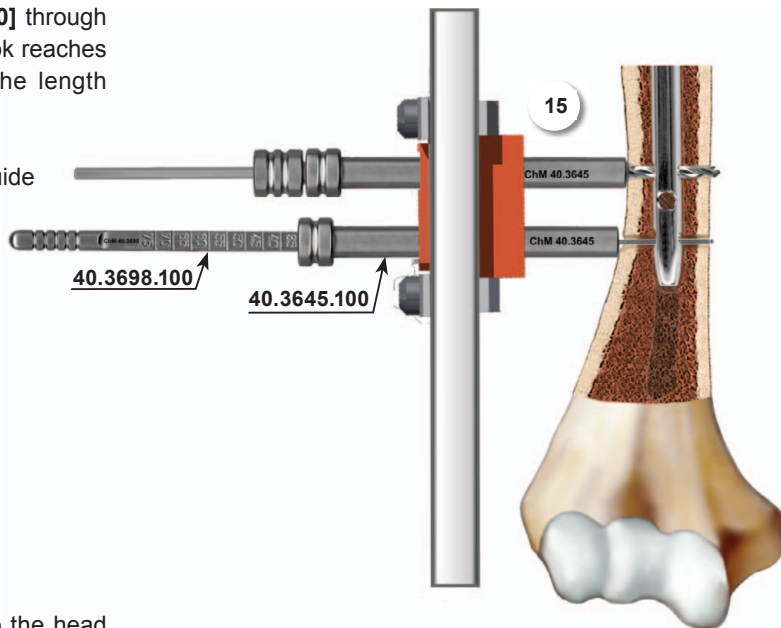

- 16 Insert the tip of the Screwdriver [40.5031] into the head of the specified locking screw. Then advance such system into the Protective Guide [40.3645.100] and insert the locking screw into prepared hole until the head of the screw reaches the cortex bone (the groove on the Screwdriver shaft matches the edge of the Protective Guide).

Remove the Screwdriver.

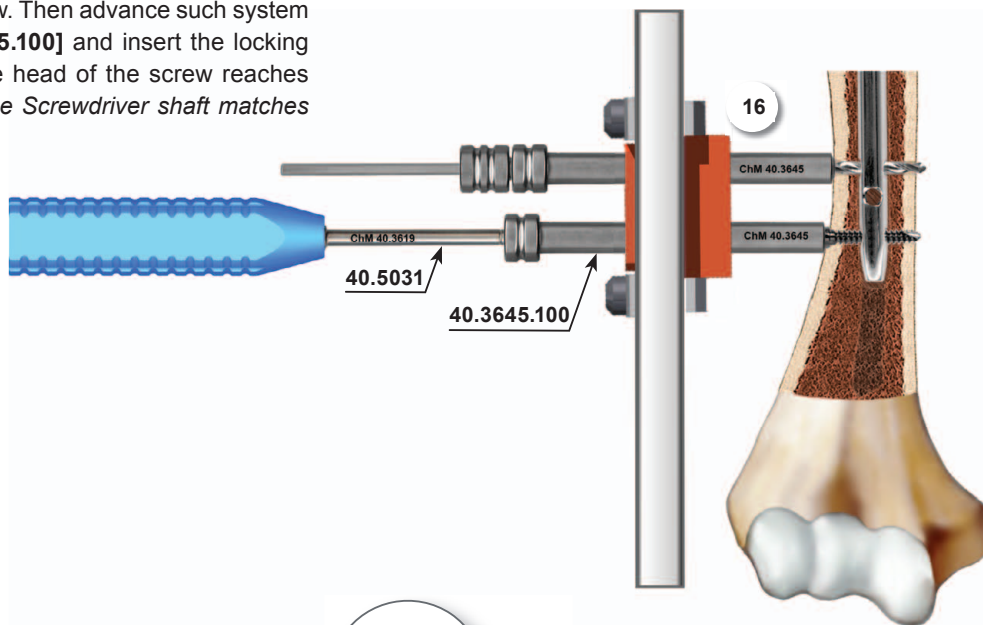

- 17 Remove the Drill [40.5331.001] or [40.5332.001] and the Drill Guide [40.3646.100] or [40.3661.100] from the proximal slider hole of the Targeter.

Leave the Protective Guide [40.3645.100] in the slider hole.

Insert the Screw Length Measure [40.3698.100] through the Protective Guide [40.3645.100], until its hook reaches the cortex on the other side of the bone. Read the length of the locking screw on the B-D scale.

During the measurement the end of the Protective Guide should rest on the cortex bone.

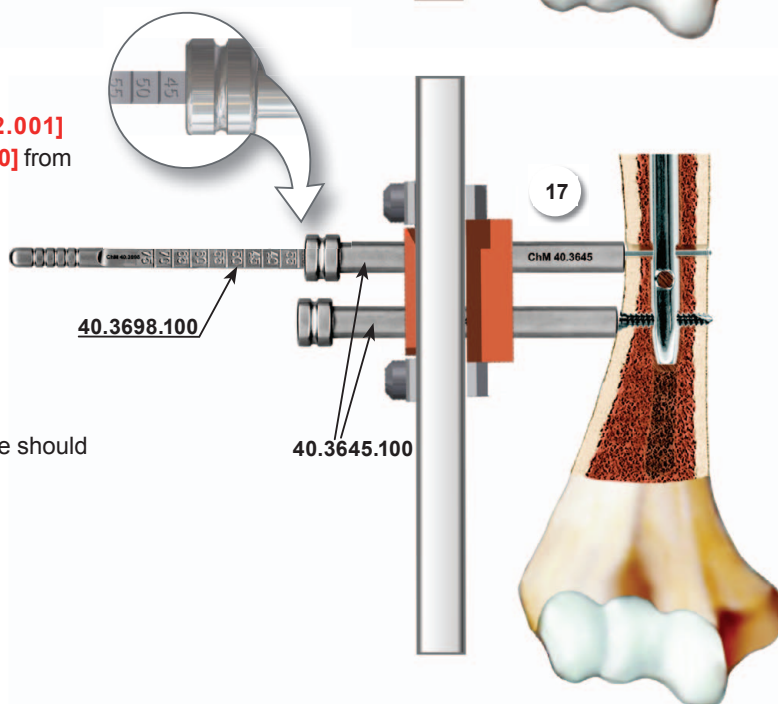

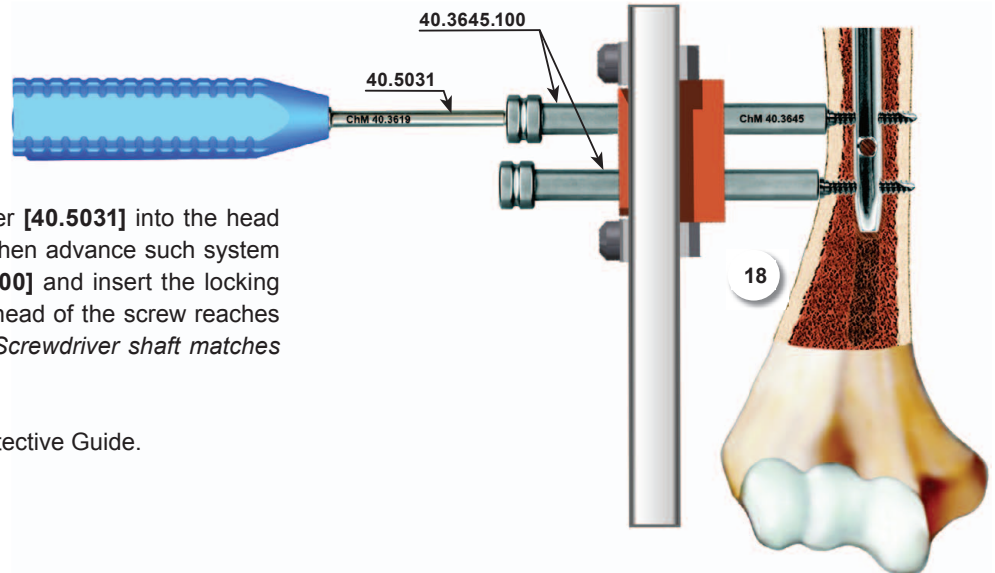

18 Insert the tip of the Screwdriver [40.5031] into the head of the definite locking screw. Then advance such system into the Protective Guide [40.3645.100] and insert the locking screw in the prepared hole until the head of the screw reaches the cortex bone (*the groove on the Screwdriver shaft matches the edge of the Protective Guide*).

Remove the Screwdriver and the Protective Guide.

IV.6. PROXIMAL LOCKING OF THE NAIL

IV.6.1. Dynamic method and dynamic with compression (*compressive*)

 The hole marked as COMPRESSION on the proximal part of the targeter should be used in dynamic or compressive intramedullary fixation.

19 Insert the Protective Guide [40.3645.100] with the Trocar 6.5 [40.3647] into the Targeter B hole marked as COMPRESSION. Mark on the skin the entry point for locking screw using the Trocar and make adequate 1.5 cm long incision through the soft tissues. Advance the Protective Guide with the Trocar into prepared incision until the tip reaches the cortex bone. Mark the entry point for the Drill.

Remove the Trocar.
Leave the Protective Guide in place

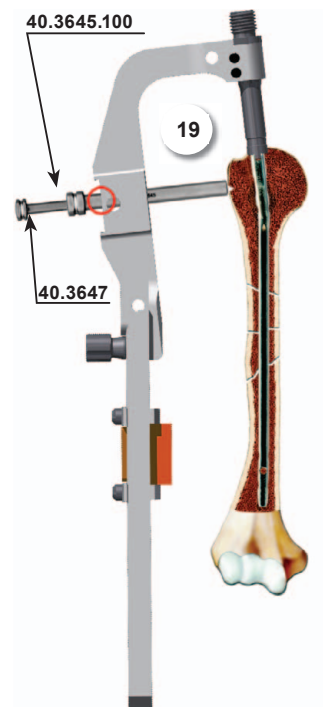

20 Insert a Drill guide 3.5 [40.3646.100] in the Protective guide [40.3645.100]. Using an electric drill and guiding the Drill 3.5/240 [40.5331.001] in the Drill guide, make a hole for a locking screw under the control of X-Ray.

Remove the Drill and the Drill Guide.
Leave the Protective Guide in the hole of the Humeral Targeter B [40.5030].

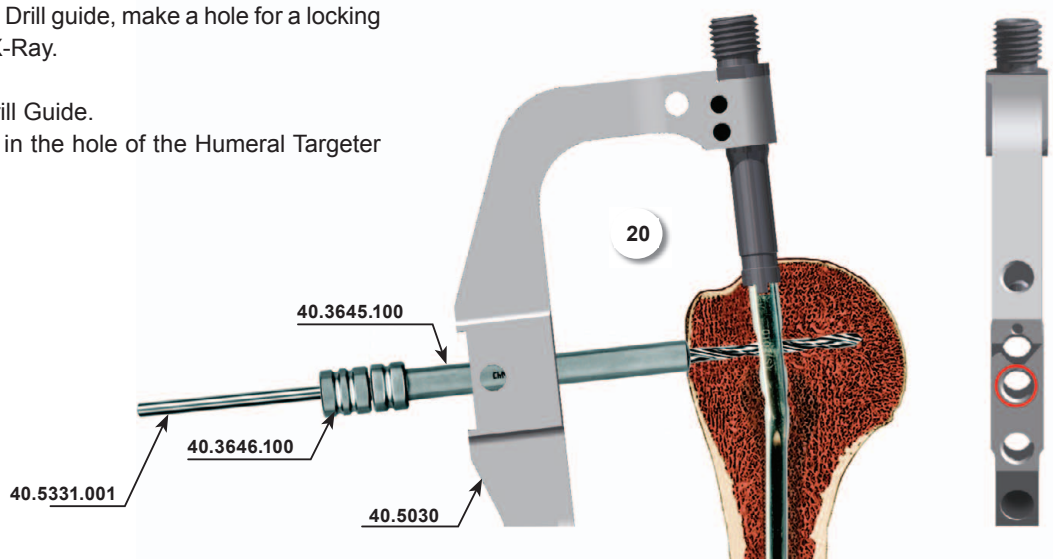

20a Insert the Drill Guide 6.5/4.5 [40.3697.100] into the Protective Guide [40.3645.100]. Advance the Drill With Scale 4.5/240 [40.5336.001] through the Drill Guide and widen the hole in the first cortex bone.

Remove the Drill and the Drill Guide.
Leave the Protective Guide in the Targeter hole.

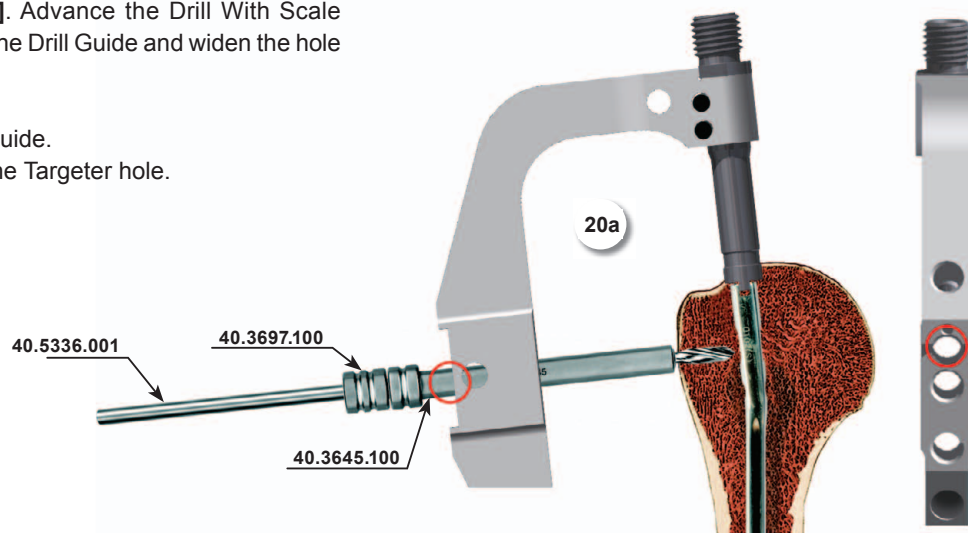

21 Insert the Screw Length Measure [40.3698.100] through the Protective Guide [40.3645.100] into the drilled hole until its tip reaches the end of the hole. Read the length of the locking screw on the D-B scale.

During the measurement the end of the Protective Guide should rest on the cortex bone.

Remove the Screw Length Measure.
Leave the Protective Guide in hole of the Targeter.

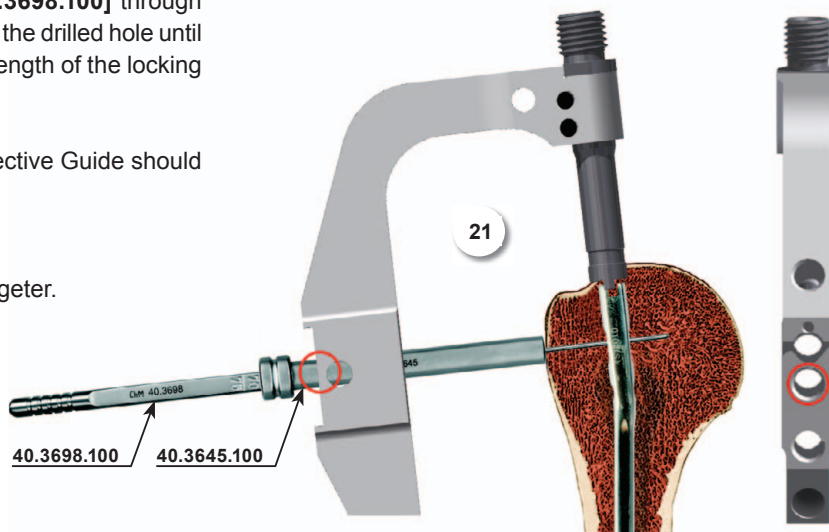

22 Insert the tip of the Screwdriver [40.5031] into the socket of the definite locking screw. Then advance such system into the Protective Guide [40.3645.100]. Insert the locking screw into the prepared hole until the head of the screw reaches the cortex of the bone (*the groove on the Screwdriver shaft matches the edge of the Protective Guide*).

Remove the Screwdriver and Protective Guide.

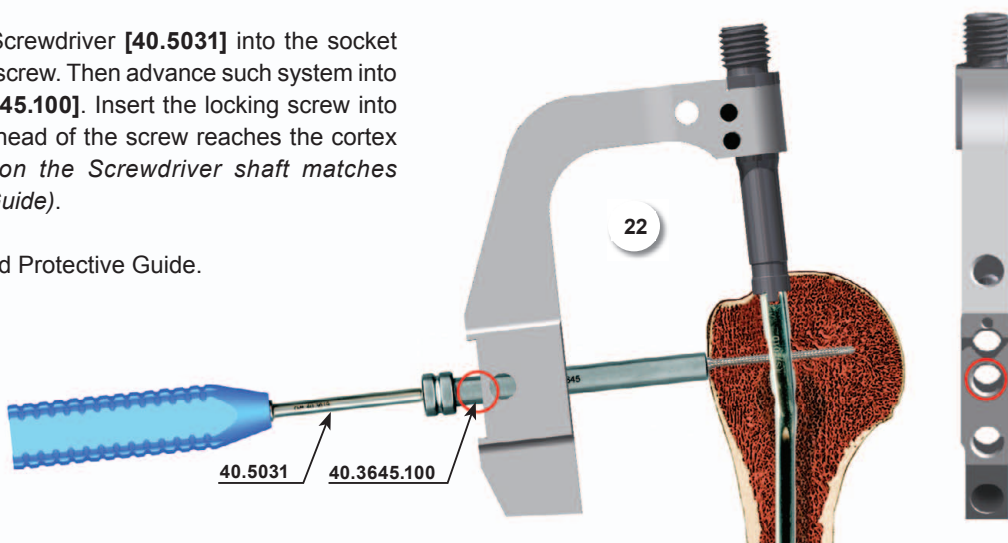

IV.7. STATIC METHOD



The hole marked as STAT on the proximal part of the Targeter should be used in static fixation. The second hole may be used for nail locking by the second locking screw (by proximal screw).

23 Insert the Protective Guide [40.3645.100] with the Trocar 6.5 [40.3647] into the Humeral Target B [40.5030] hole marked as STAT. Mark on the skin the entry point for the locking screw and make an adequate incision through the soft tissues approx. 1.5cm in length. Insert the Protective Guide together with the Trocar until its end reaches the cortex bone and mark the entry point for the drill.

Remove the Trocar.
Leave the Protective Guide in the targeter hole.

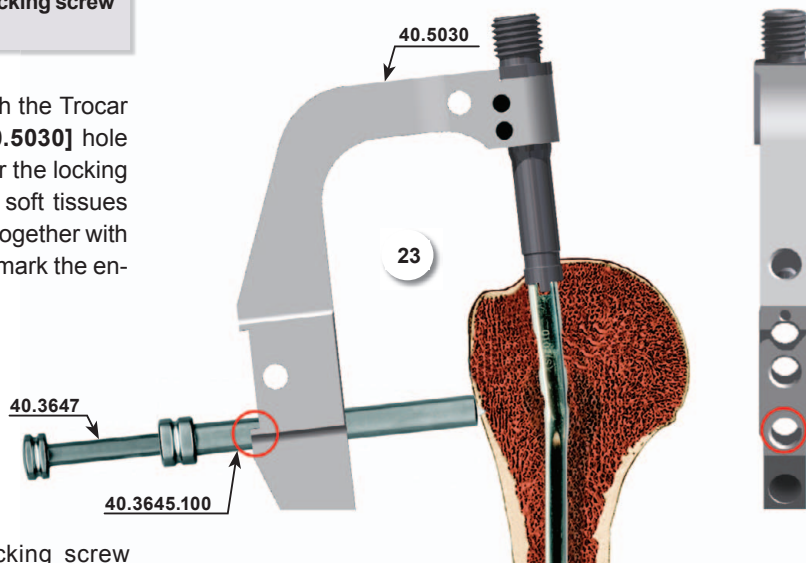

24 Drill the hole in the humeral bone for locking screw insertion.

OPTION I

Implantation of 8 or 9mm nails (with use 4.5 screws).

Insert the Drill Guide 6.5/3.5 [40.3646.100] into the Protective Guide [40.3645.100]. Mount the Drill With Scale 3.5/240 [40.5331.001] on the surgical drive and advance it through the Drill Guide. Drill the hole in the humerus through both cortex layers under the X-Ray control. The scale on the Drill indicates length of locking element.

OPTION II

Implantation of 6 or 7mm nails (with use 3.5 screws).

Insert the Drill Guide 6.5/2.8 [40.3661.100] into the Protective Guide [40.3645.100]. Mount the Drill With Scale 2.8/240 [40.5332.001] on the surgical drive and advance it through the Drill Guide. Drill the hole in the humerus through both cortex layers under the X-Ray control. The scale on the Drill indicates length of locking element.

Remove the Drill and the Drill Guide.
Leave the Protective Guide.

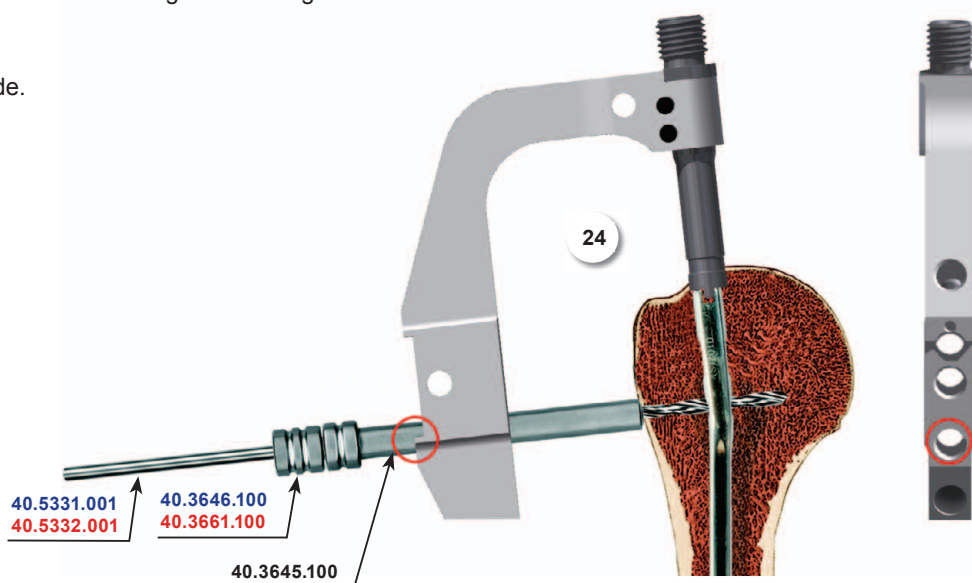

- 25 Insert the Screw Length Measure [40.3698.100] through the Protective Guide [40.3645.100] into drilled hole until its tip reaches the end of the hole. Read the length of the locking screw on the B-D scale. During the measurement the end of the Protective Guide should rest on the cortex bone.

Remove the Screw Length Measure.
Leave the Protective Guide in the hole of the Targeter.

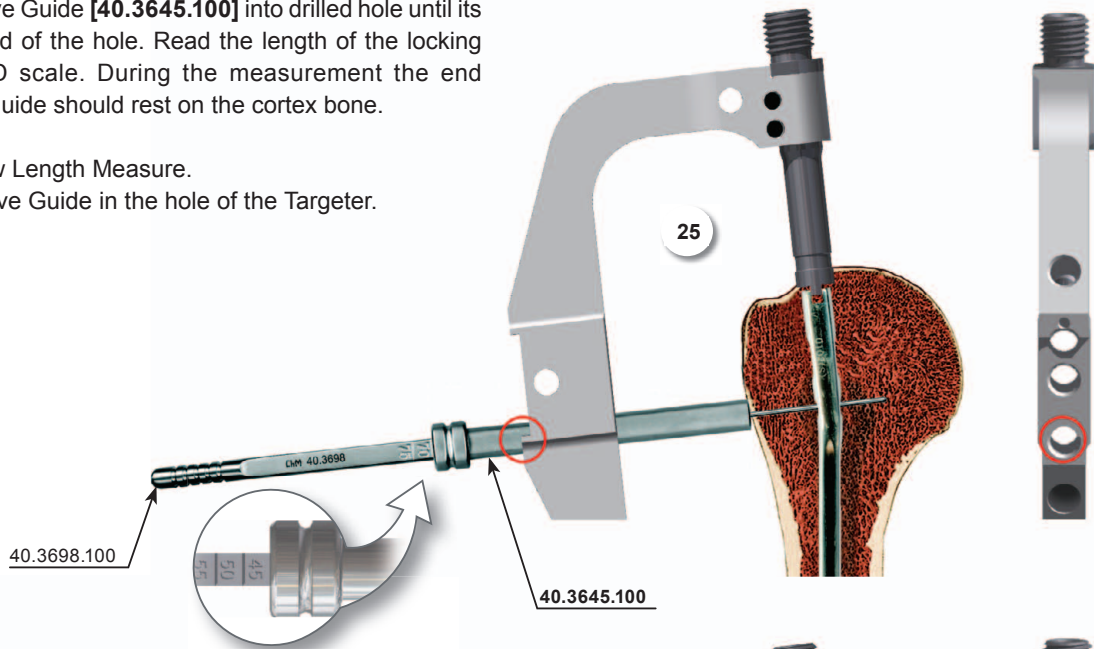

- 26 Insert the tip of the Screwdriver [40.5031] into head of the specified locking screw. Then advance such system into the Protective Guide [40.3645.100] and insert the locking screw in the prepared hole until the head of the screw reaches the cortex bone (the groove on the Screwdriver shaft matches the edge of the Protective Guide).

Remove the Screwdriver and Protective Guide.

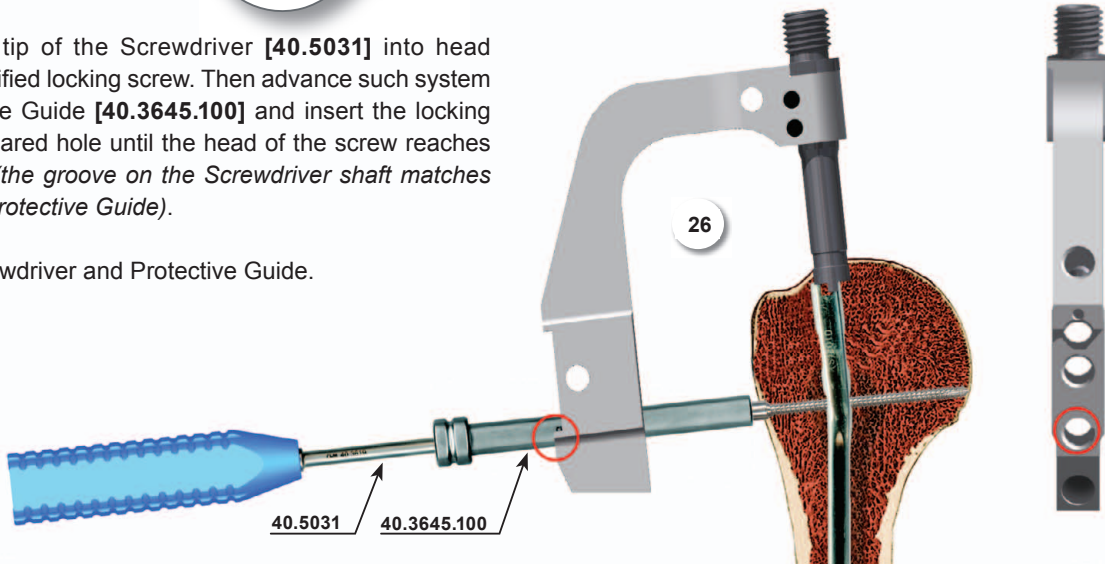

If the surgeon decides to lock the nail in the proximal part with two locking screws, insertion of second screw should be performed as shown in steps from [20] to [22] (chapter IV.6.A).



IV.8. OBLIQUE LOCKING OF THE NAIL

Design of the Humeral targeter B [40.5030] enables oblique insertion of locking screw in proximal part of the nail through the holes marked **ANGULAR** of the Targeter and using compression screw. Before starting oblique locking of the nail:

Verify with the X-Ray image intensifier the mutual position of the holes in the slider of Targeter B and the holes in proximal part of the intramedullary nail.

The holes in the nail and the slider have to be in line.

27 Insert the Protective Guide [40.3645.100] with the Trocar 6.5 [40.3647] into the hole marked as **ANGULAR** in the Humeral targeter B [40.5030]. Mark on the skin the entry point for the locking screw and make adequate 1.5cm incision in length through soft tissues. Insert the Protective Guide together with the Trocar so as to place its end as close to cortex as possible and mark the entry point for the Drill.

Remove the Trocar.
Leave the Protective Guide.

28 Insert the Drill Guide 3.5 [40.3646.100] into the Protective Guide [40.3645.100]. Mount the Drill With Scale 3.5/240 [40.5331.001] on the surgical drive and advance such system through the Drill Guide. Drill the hole for the locking screw in the humerus under the X-Ray control. The scale on the Drill indicates the length of locking element.

Remove the Drill and the Drill Guide.
Leave the Protective Guide.

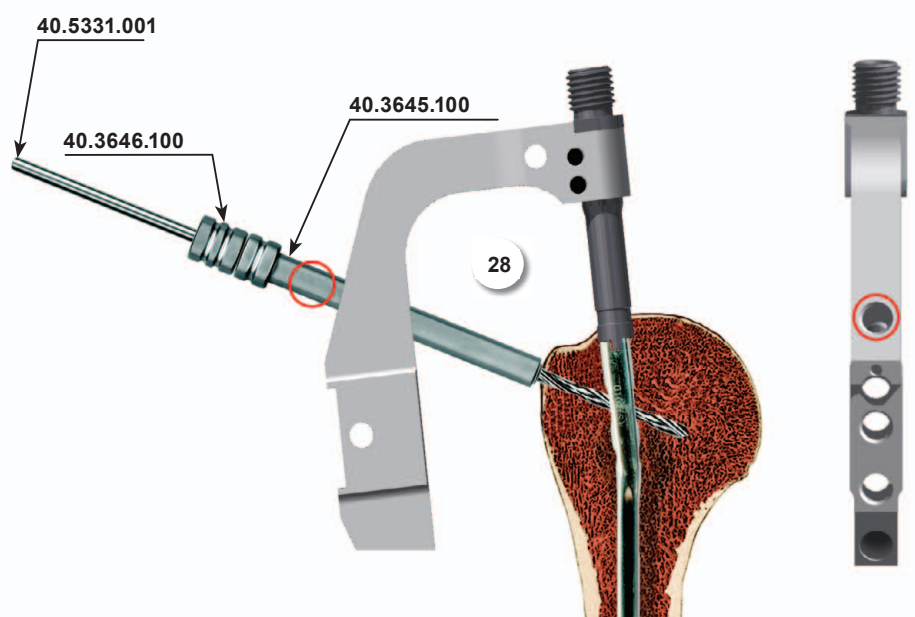
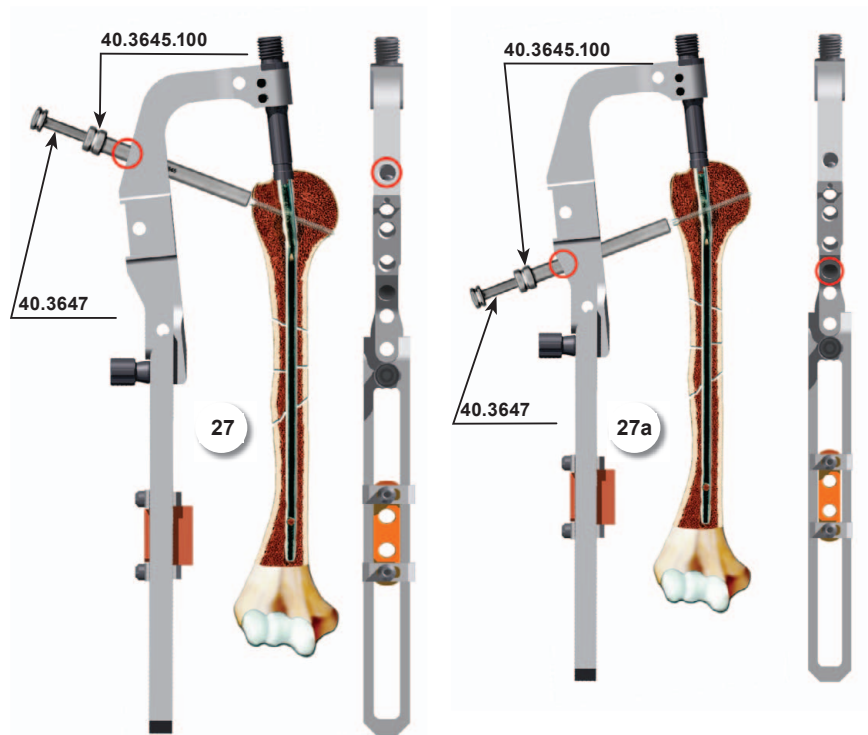

- 29 Insert the Screw Length Measure [40.3698.100] through the Protective Guide [40.3645.100] into the drilled hole until its tip reaches the end of the hole. Read the length of the locking screw on B-D scale.

Remove the Screw Length Measure.
Leave the Protective Guide.

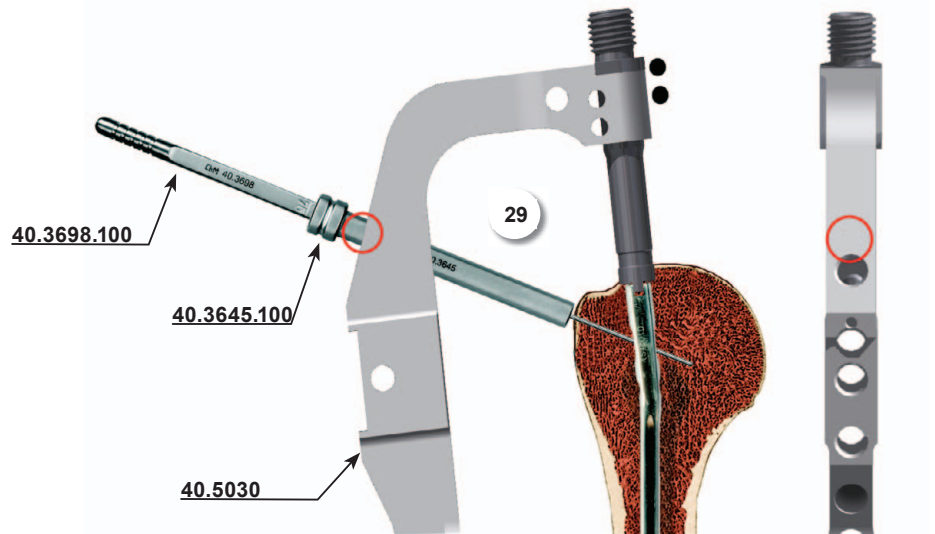

- 30 Insert the tip of the Screwdriver [40.5031] into the socket of the specified locking screw [1.1654]. Then advance both into the Protective Guide [40.3645.100] and insert the locking screw in the prepared hole (*the groove on the Screwdriver shaft matches the edge of the Protective Guide*).

Remove the Screwdriver and Protective Guide.

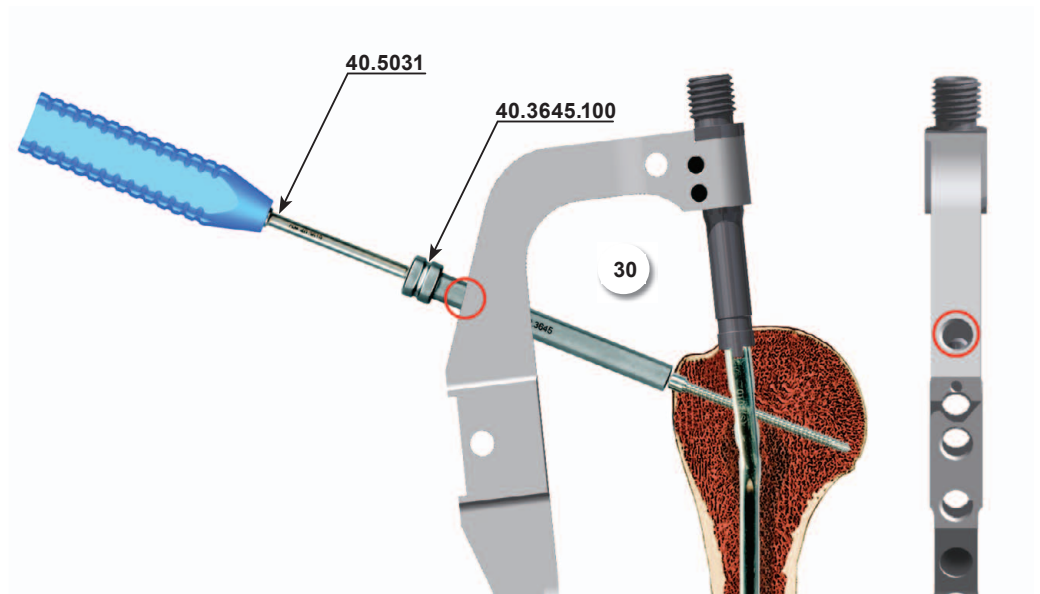

IV.9. HUMERAL NAIL REMOVAL FROM THE TARGETER

- 31 Dismount the Humeral targeter B [40.5030] from the nail using Socket Wrench S11 [40.3648] by unscrewing Connecting Screw [40.5023].

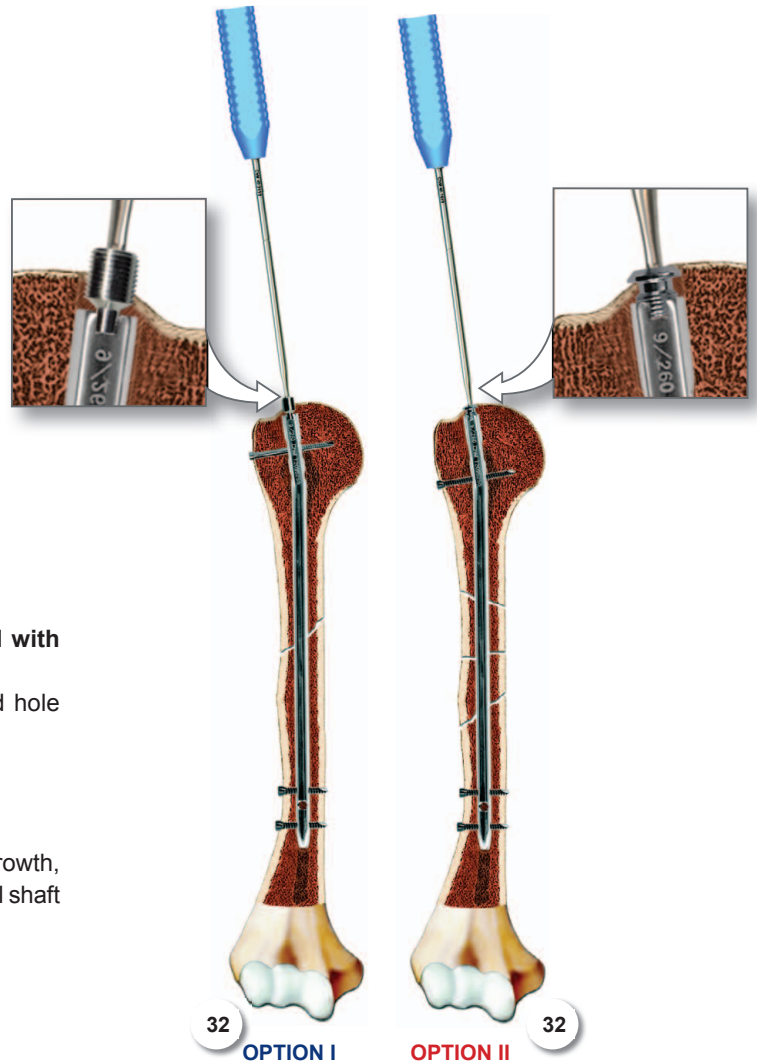

- 32 Insertion of Compression Screw or End Cap.

OPTION I

Inserting compression screw in the dynamic method with compression (compressive).

Insert the compression screw (*implant*) into the threaded hole in the nail shaft using the the Screwdriver [40.5031].

OPTION II

Inserting End Cap in the dynamic and static method.

In order to secure the inner thread of the nail from bone ingrowth, insert the End Cap (*implant*) into the threaded hole in the nail shaft using the Screwdriver [40.5031].

IV.10. PROXIMAL LOCKING OF A SHORT RECONSTRUCTION HUMERAL NAIL

In order to lock reconstruction humeral nail, it is necessary to mount the Angular targeter [40.5024] to the Humeral targeter B [40.5030] as showed in the picture. Threaded shaft (5) of the Angular targeter I (1) insert into lateral hole of the Humeral targeter B [40.5030] then into the connective hole of Angular targeter II (3). Connect parts by inserting the nut (4).

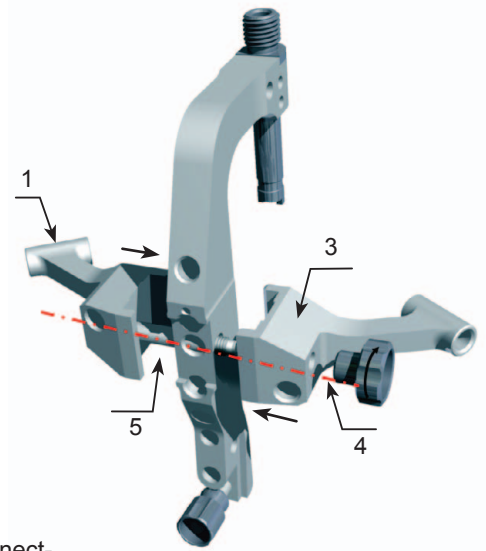

- 33 Using the Socket Wrench S11 [40.3648] and the Connecting Screw [40.5023.100] connect the intramedullary nail to the leading sleeve of the Humeral targeter B [40.5030].



Properly installed nail shall be positioned parallel to the arm of Targeter B.

- 34 Connect the Impactor-Extractor [40.3665] to the installed system (insert on the threaded tip of the the Humeral targeter B leading sleeve [40.5030]).

- 35 Insert the Protective Guide [40.3645.100] with the Trocar 6.5 [40.3647] into one of the holes I, II, III or IV in the Angular reconstruction targeter [40.5024]. Mark on the skin the entry point for the locking screw and make the adequate incision through the soft tissues approx. 1.5cm in length. Insert the Protective Guide together with the Trocar until its end reaches the cortex bone and mark the entry point for the Drill.

Remove the Trocar.
Leave the Protective Guide.

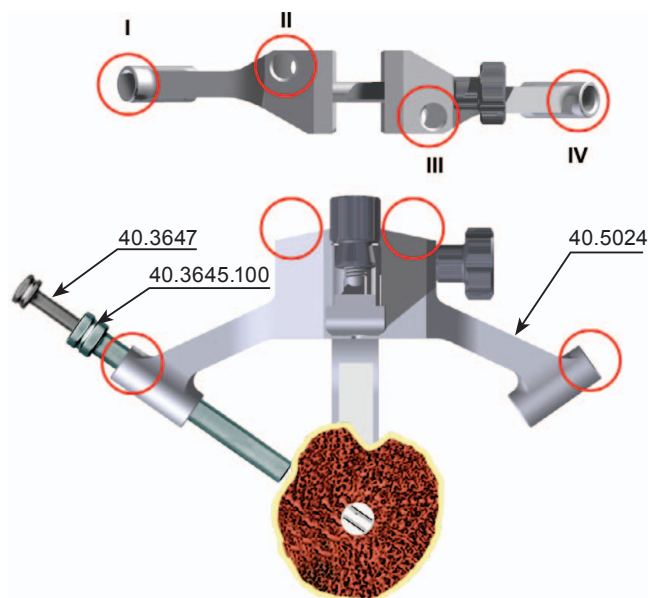

- 36 Insert the Drill Guide 6.5/3.5 [40.3646.100] into the Protective Guide [40.3645.100]. Mount the Drill With Scale 3.5/240 [40.5331.001] on the surgical drive and advance it through the Drill Guide. Drill the hole for locking screw in the humerus under the X-Ray control. Scale on the Drill indicates the locking element.

Leave the Protective Guide with the Drill and the Drill Guide in the hole of the Humeral targeter B [40.5030].

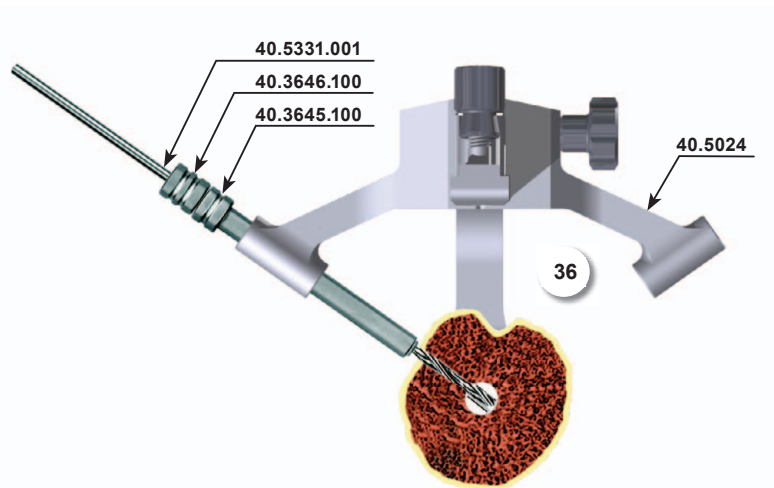

- 37 Insert the Protective Guide [40.3645.100] with the Trocar 6.5 [40.3647] into the next hole of Angular targeter [40.5024]. Mark on the skin the entry point for the locking screw, make an adequate incision through the soft tissues approx. 1.5 cm in length. Insert the Protective Guide together with the Trocar until its end is placed as close to cortex as possible and mark the entry point for the Drill using the Trocar.

Remove the Trocar.
Leave the Protective Guide in the hole of the Targeter.

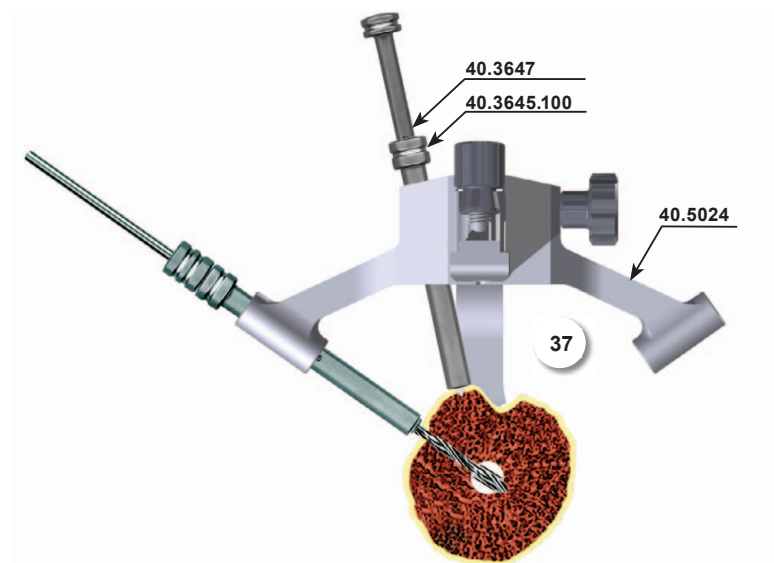

- 38 Insert the Drill Guide 6.5/3.5 [40.3646.100] into the Protective Guide [40.3645.100]. Mount the Drill With Scale 3.5/240 [40.5331.001] on the surgical drive and advance it through the Drill Guide. Drill the hole for locking screw under the X-Ray control.

Remove the Drill Guide.
Leave the Protective Guide in the hole of the Humeral targeter B [40.5030].

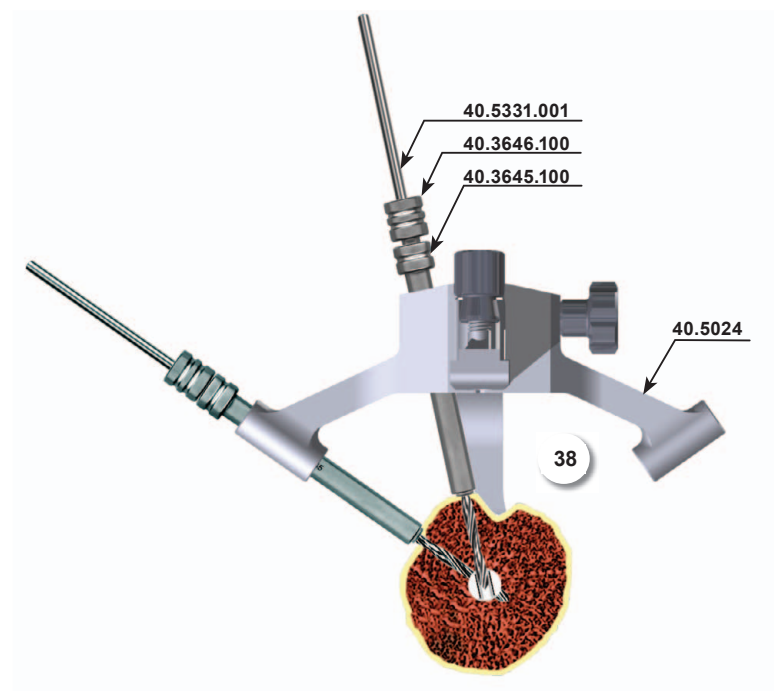

39 In case of locking with use of locking screws 4.5 [1.1653.xxx], ream the hole through using the Drill With Scale 4.5/240 [40.5336.001] (first, insert the Drill Guide 6.5/4.5 [40.3697.100] into the Protective Guide 9.0/6.5 [40.3645.100]).

Remove the Drill and the Drill Guide.
Leave the Protective Guide in the hole of the Targeter.

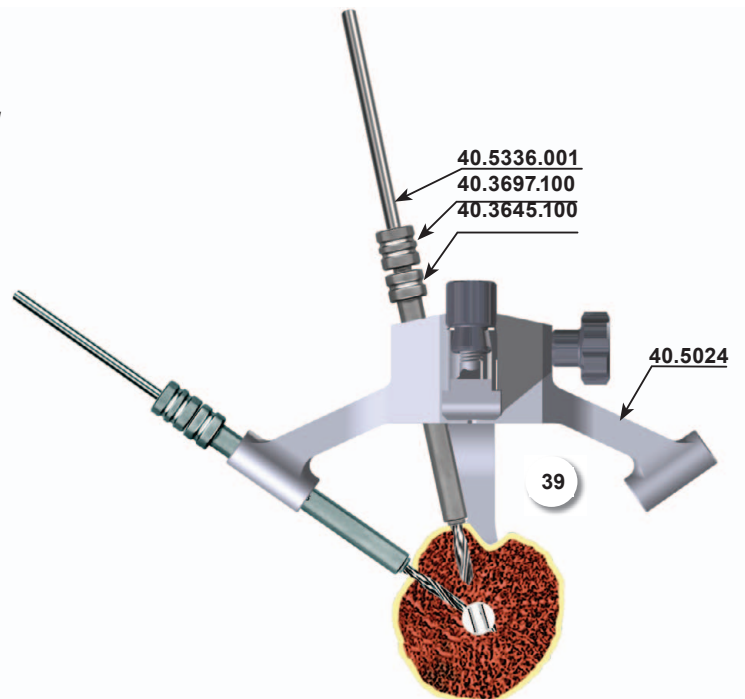

40 Insert the Screw Length Measure [40.3698.100] through the Protective Guide [40.3645.100] into the drilled hole until its tip reaches the end of the hole. Read the length of the locking screw on B-D scale.

Remove the Screw Length Measure.
Leave the Protective Guide in hole of the Targeter.

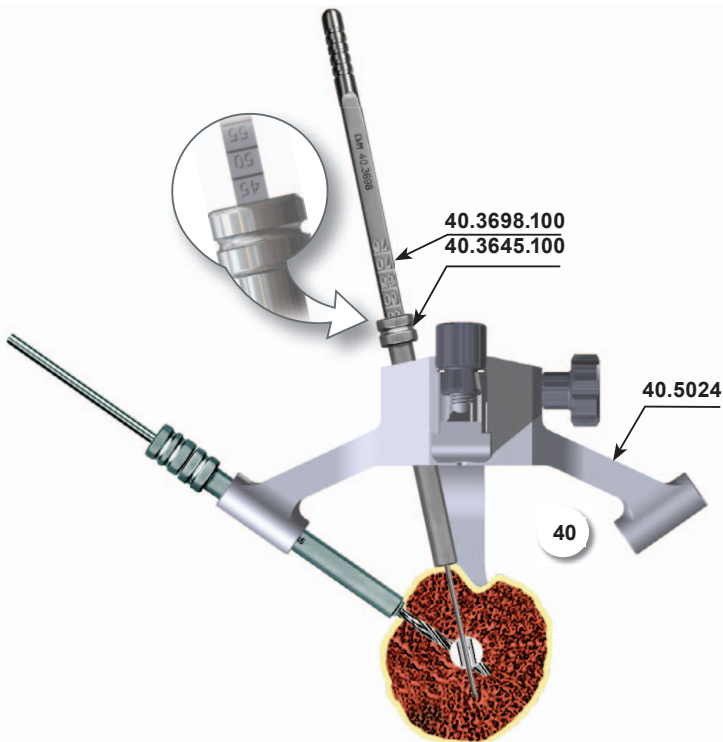

41 Insert the tip of the the Screwdriver [40.5031] into the socket of locking screw:

- 4.5 [1.1653] in case of standard locking; or
- 5.0 [1.1657] in case of locking in threaded hole of the nail.

Then advance such system into the Protective Guide [40.3645.100] and slowly insert the locking screw into the prepared hole (until the groove of the Screwdriver shaft matches the edge of the Protective Guide).

Remove the Screwdriver.
Leave Protective Guide.

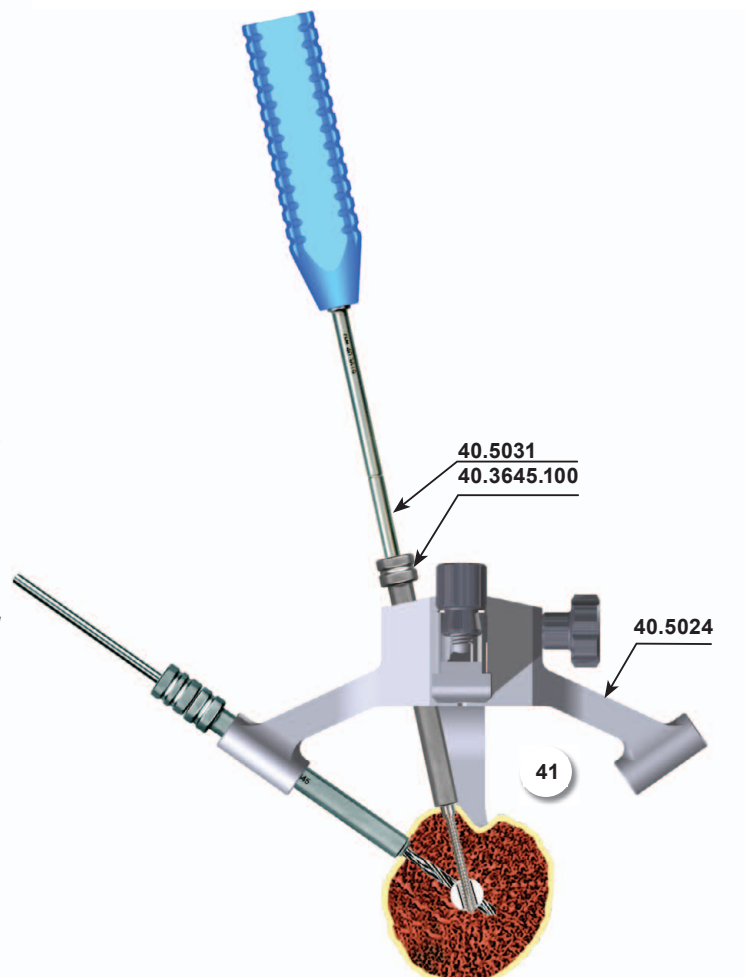

- 42 Remove the Drill With Scale 3.5/240 [40.5331.001] and the Drill Guide 6.5/3.5 [40.3646.100] from the proximal hole of the Targeter. Leave in hole the Protective Guide [40.3645.100]. Insert the Screw Length Measure [40.3698.100] through the Protective Guide [40.3645.100] into the drilled hole until its tip reaches the end of the hole. Read the length of the locking screw on B-D scale.

During the measurement the end of the Protective Guide should rest on the cortex bone.

Remove the Screw Length Measure.
Leave the Protective Guide in hole of the Targeter.

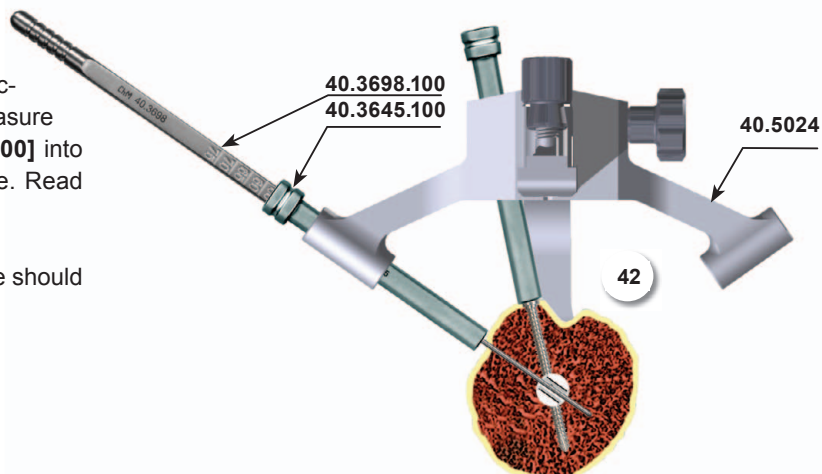

- 43 Insert the tip of the Screwdriver [40.5031] into the socket of locking screw:
- 4.5 [1.1653] in case of standard locking; or
- 5.0 [1.1657] in case of locking in threaded hole of the nail.

Then advance both into the Protective Guide [40.3645.100] and carefully insert the locking screw into the prepared hole (until the groove on the Screwdriver shaft matches the edge of the Protective Guide).

Remove the Screwdriver and Protective Guide.

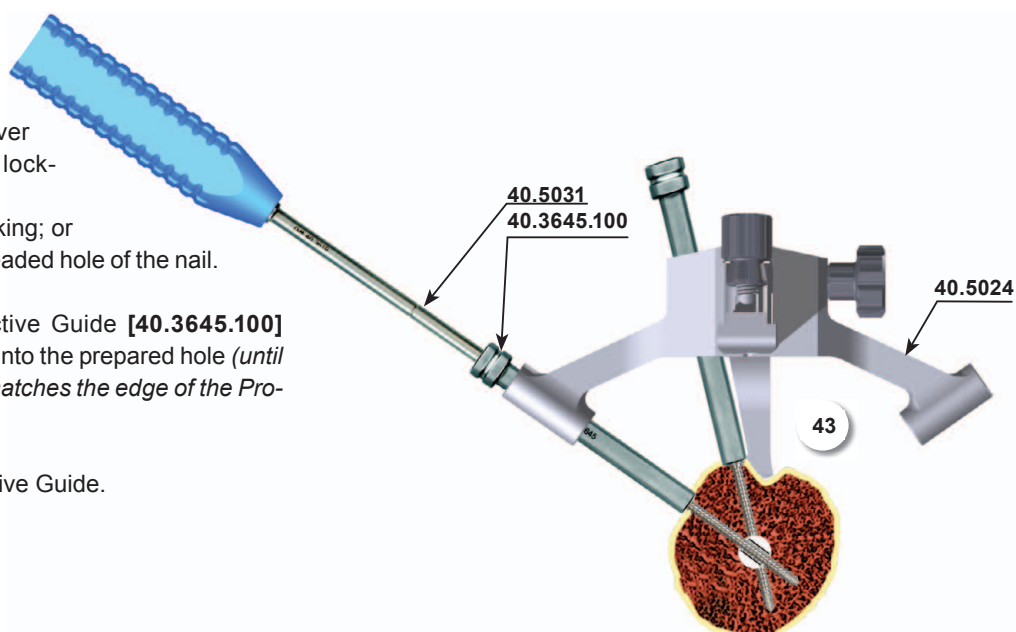

- 44 In order to enable locking the nail in another proximal holes, it is recommended (after drilling the first hole and checking the correctness of the process) to leave the Drill in the hole and start locking the rest of holes or the nail and to leave the Protective Guide on the head of locking screw in order to improve the system: nail – Targeter.

Repeat steps 37-41 in order to lock the nail using other holes.

IV.11. DISTAL LOCKING OF A SHORT RECONSTRUCTION HUMERAL NAIL

45 Insert the Protective Guide [40.3645.100] with the Trocar 6.5 [40.3647] into the hole of the Humeral targeter B marked as RECONSTRUCTION [40.5030]. Mark on the skin the entry point for locking screw and make an adequate incision through soft tissues 1.5cm in length. Advance the Protective Guide together with the Trocar so as to put its end as close to cortex as possible and mark the entry point for the Drill.

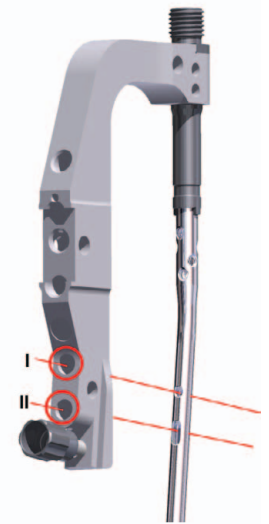

Remove the Trocar.
Leave the Protective Guide in the hole of the Targeter.

46 Drill the hole in bone for locking screw insertion.

OPTION I

Implantation of 8 or 9mm nails (for locking use 4.5 screws).

Insert the Drill Guide 6.5/3.5 [40.3646.100] into the Protective Guide [40.3645.100]. Mount the Drill With Scale 3.5/240 [40.5331.001] on the surgical drive and advance it through the Drill Guide [40.3646.100] and drill the hole in the humerus through both cortex layers under the X-Ray control. The scale on the Drill indicates the length of locking element.

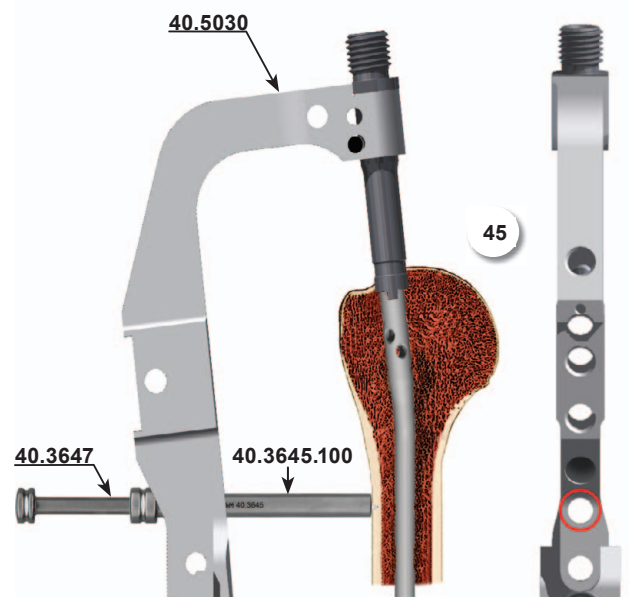

OPTION II

Implantation of 6 or 7mm nails (for locking use 3.5 screws).

Insert the Drill Guide 6.5/2.8 [40.3661.100] into the Protective Guide [40.3645.100]. Mount the Drill With Scale 2.8/240 [40.5332.001] on the surgical drive and advance it through the Drill Guide. Drill the hole in the humerus through both cortex layers under the X-Ray control. The scale on the Drill indicates the length of locking element.

After disconnecting the surgical drive and Drill, leave in place system: Protective Guide – Drill Guide – Drill.

OPTION I [40.3645.100] - [40.3646.100] - [40.5331.001]

OPTION II [40.3645.100] - [40.3661.100] - [40.5332.001]

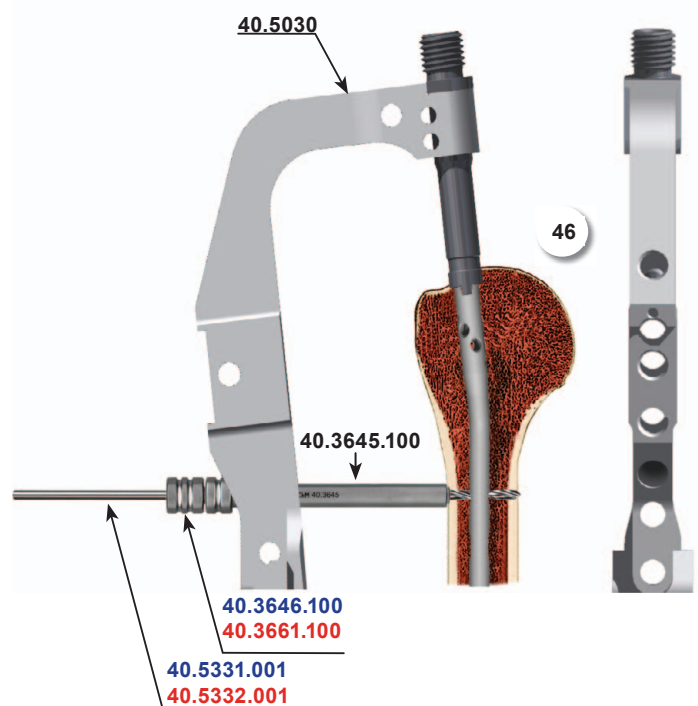

- 47 Insert the Protective Guide [40.3645.100] with the Trocar 6.5 [40.3647] into the second hole marked as RECONSTRUCTION. Mark the entry point for the second locking screw. Repeat step 45.

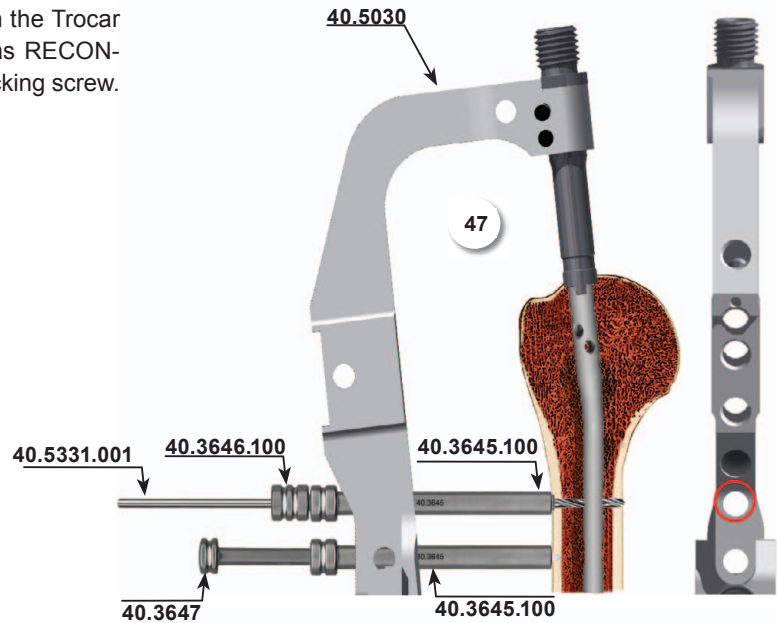

- 48 Drill the hole in the humerus for insertion of the second locking screw. Repeat step 46. Directly after making the hole, the Drill [40.5331.001] or [40.5332.001] and the Drill Guide 6.5/3.5 [40.3646.100] or [40.3661.100] should be removed.

Leave the Protective Guide in the hole of the Targeter slider.

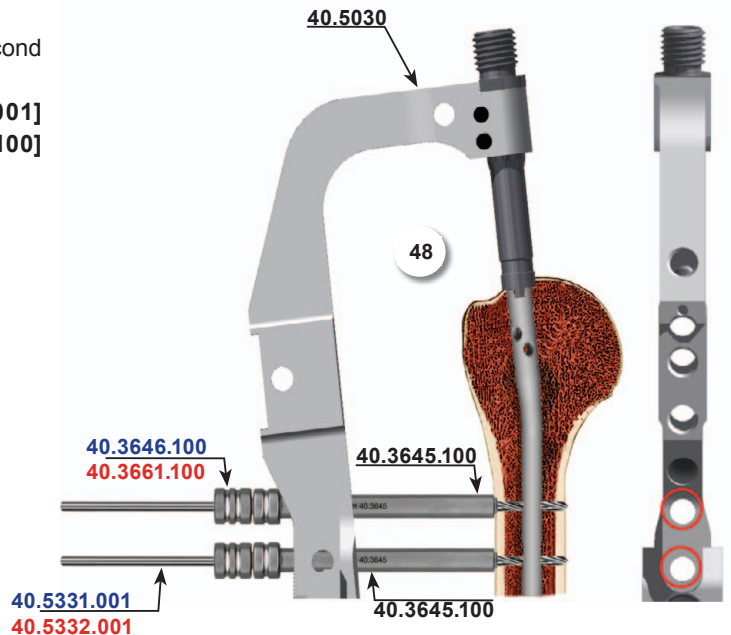

- 49 Insert the Screw Length Measure [40.3698] through the Protective Guide [40.3645.100] into the drilled hole until its hook reaches the cortex on the other side of the bone. Read the length of the locking screw on B-D scale.

During the measurement the end of the Protective Guide should rest on the cortex bone.

Remove the Screw Length Measure. Leave the Protective Guide in hole of Targeter.

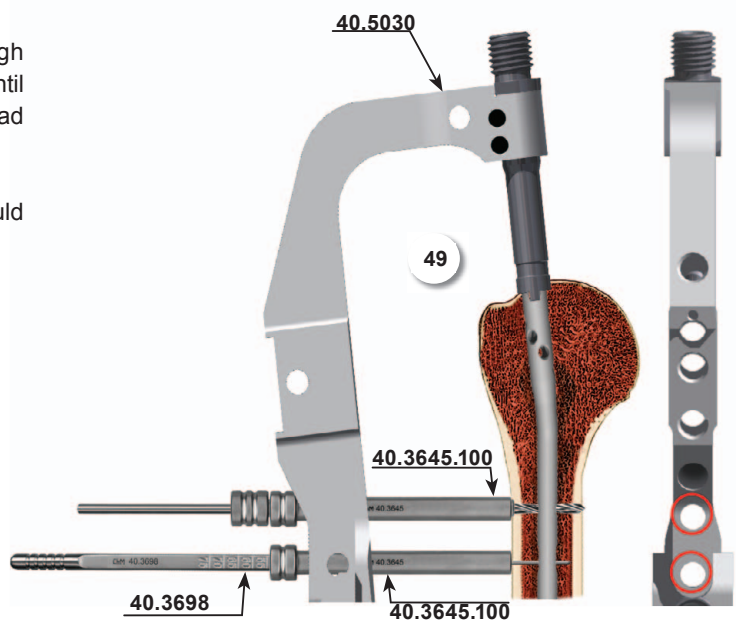

50 Insert the tip of the Screwdriver [40.5031] into the socket

of the definite locking screw. Then advance both into the Protective Guide [40.3645.100] and insert the locking screw in the prepared hole until the head of the screw reaches the cortex of the bone (*the groove on the Screwdriver shaft matches the edge of the Protective Guide*).

Remove the Screwdriver.

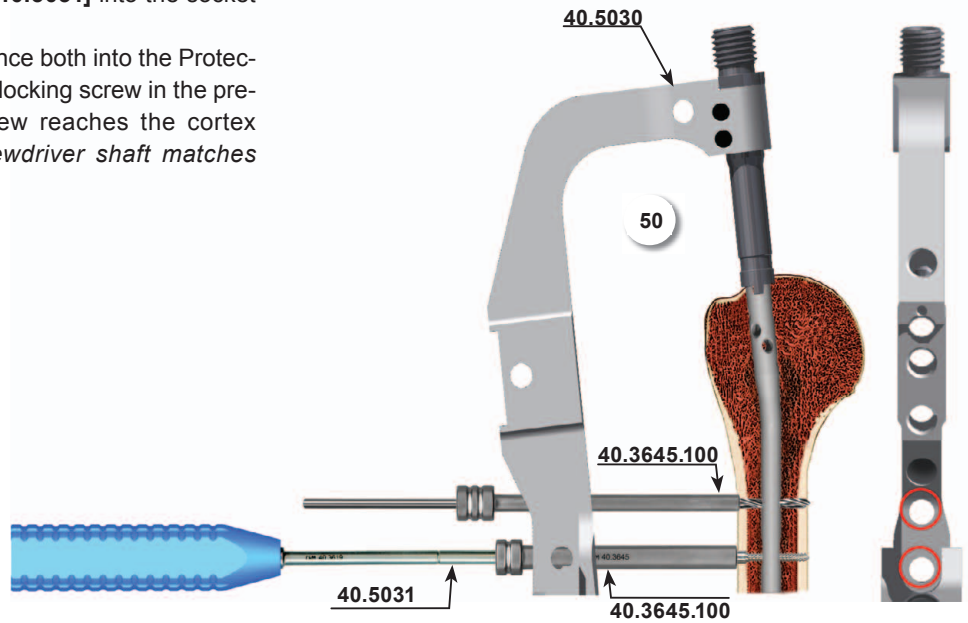

51 Remove the Drill [40.5331.001] and the Drill Guide 6.5/3.5 [40.3646.100] from the first hole marked as **RECONSTRUCTION**. Leave the Protective Guide [40.3645.100] in the hole of the slider. Insert the Screw Length Measure [40.3698.100] through the Protective Guide into the drilled hole until its hook reaches the cortex on the other side of the bone. Read the length of the locking screw on B-D scale.

During the measurement the end of the Protective Guide should rest on the cortex bone.

Remove the Screw Length Measure.
Leave the Protective Guide in hole of Targeter B.

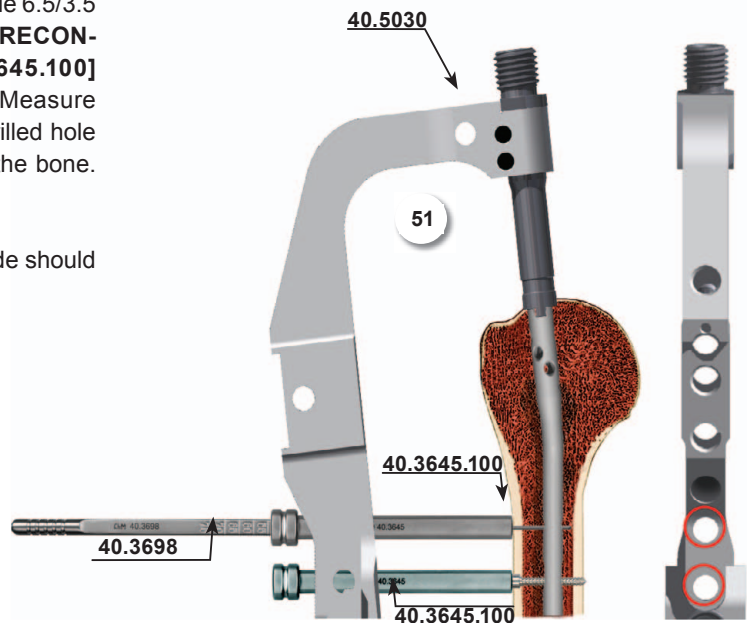

52 Insert the tip of the the Screwdriver [40.5031] into the socket

of the definite locking screw. Then advance both into the Protective Guide [40.3645.100] and insert the locking screw into the prepared hole until the head of the screw reaches the cortex bone (*the groove on the Screwdriver shaft matches the edge of the Protective Guide*).

Remove the Screwdriver and Protective Guide.

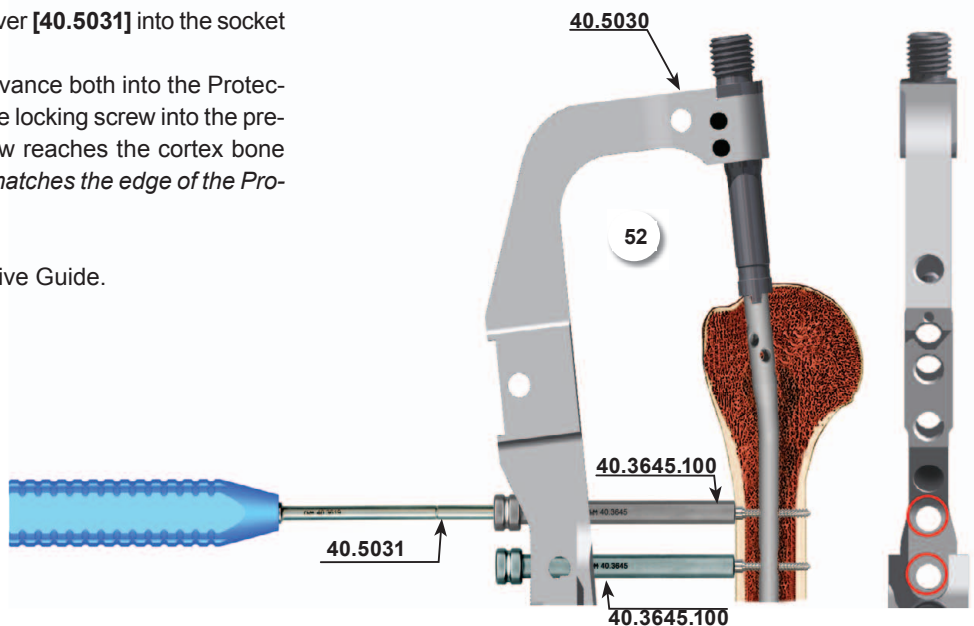

IV.12. DISTAL LOCKING OF A LONG RECONSTRUCTION HUMERAL NAIL

Before starting distal locking of the nail, verify using X-Ray image intensifier and Aiming inserts [40.5065.009] the mutual position of the Targeter slider holes and holes in nail distal part.

Holes of the nail and the slider have to be in line.

53 Insert the Protective Guide [40.3645.100] with the Trocar 6.5 [40.3647] into the proximal hole in the Targeter slider. After marking on the skin the points for inserting the locking screws make incision through the soft tissues, approx. 1.5 cm in length. Advance the Protective Guide with the Trocar into prepared incision so as to put its end as close to cortex as possible. Using the Trocar mark the point for the locking screw.

Remove the Trocar.
Leave the Protective Guide in the hole of the slider.

54 Drill the hole in bone for locking screw insertion.

OPTION I

Implantation of 8 or 9 mm nails (with use of 4.5 screws).

Insert the Drill Guide 6.5/3.5 [40.3646.100] into the Protective Guide [40.3645.100]. Mount the Drill With Scale 3.5/240 [40.5331.001] on the surgical drive and advance it through the Drill Guide 6.5/3.5 [40.3646.100] and drill the hole in the humerus through both cortex layers under the X-Ray control. The scale on the Drill indicates length of locking element.

OPTION II

Implantation of 6 or 7 mm nails (with use of 3.5 screws).

Insert the Drill Guide 6.5/2.8 [40.3661.100] into the Protective Guide [40.3645.100]. Mount the Drill With Scale 2.8/240 [40.5332.001] on the surgical drive and advance it through the Drill Guide. Drill the hole in the humerus through both cortex layers under the X-Ray control. The scale on the Drill indicates length of locking element. After disconnecting the surgical drive and Drill, leave in place system: Protective Guide – Drill Guide – Drill.

OPTION I [40.3645.100] - [40.3646.100] - [40.5331.001]
OPTION II [40.3645.100] - [40.3661.100] - [40.5332.001]

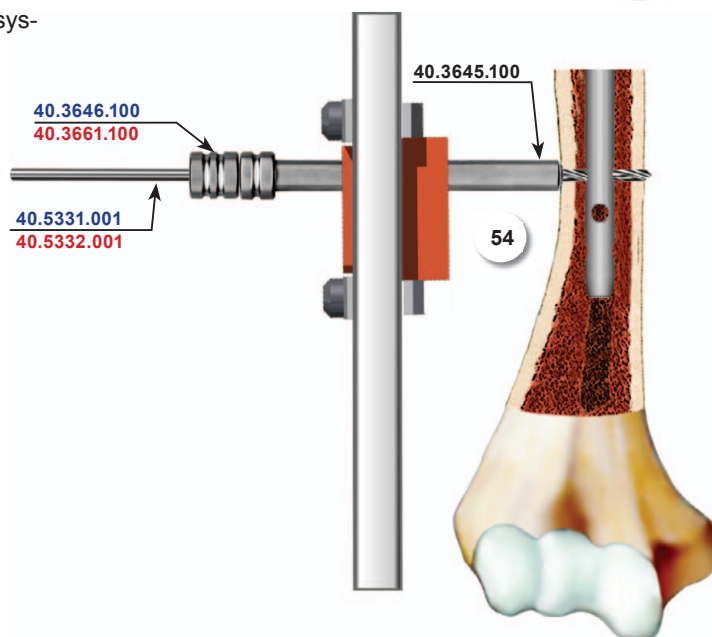

- 55 Insert the Protective Guide [40.3645.100] with the Trocar 6.5 [40.3647] into the distal hole in the Targeter B slider. Advance the Protective Guide with the Trocar into prepared incision until its end reaches the cortex. Using the Trocar mark the point for the locking screw.

Remove the Trocar.
Leave the Protective Guide in the hole of the slider.

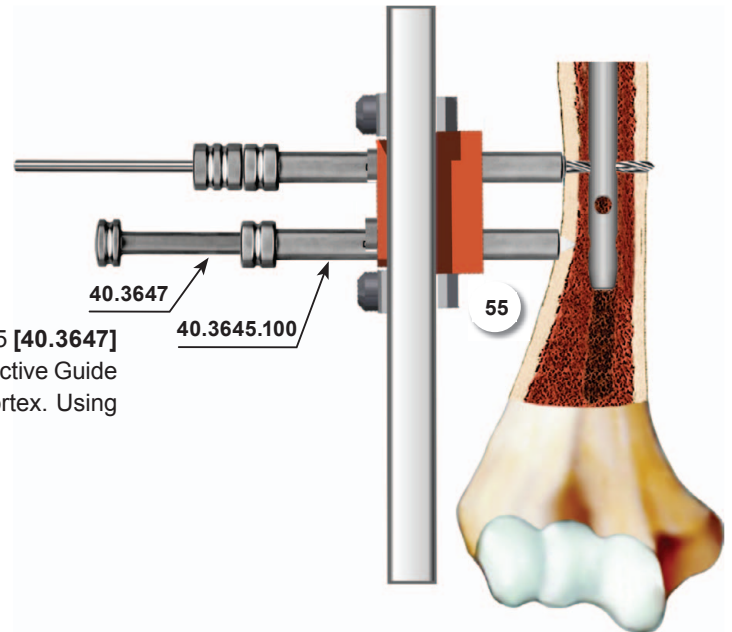

- 56 Make the canal in the bone for the second locking screw insertion. Repeat 12 step. Remove the Drill [40.5331.001] or [40.5332.001] and the Drill Guide [40.3646.100] or [40.3661.100] just after reaming of the canal.

Leave the Protective Guide in the hole of the slider of targeter.

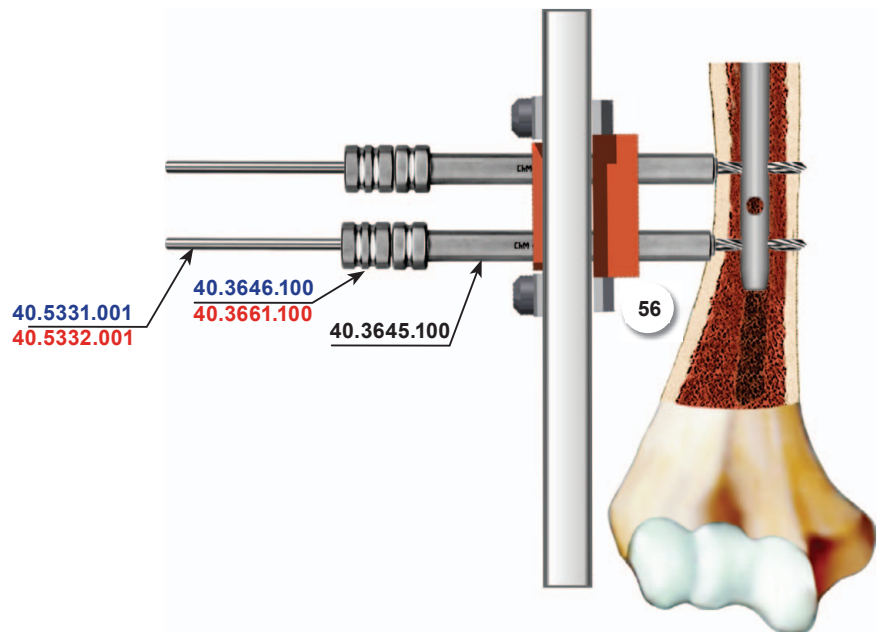

- 57 Insert the Screw Length Measure [40.3698.100] through the Protective Guide [40.3645.100] until its hook rests on the cortex on the other side of the bone. Read the length of the locking screw on the B-D scale.

During the measurement the end of the Protective Guide should rest on the cortex bone.

Remove the Screw Length Measure.
Leave the Protective Guide in the hole of slider of Targeter.

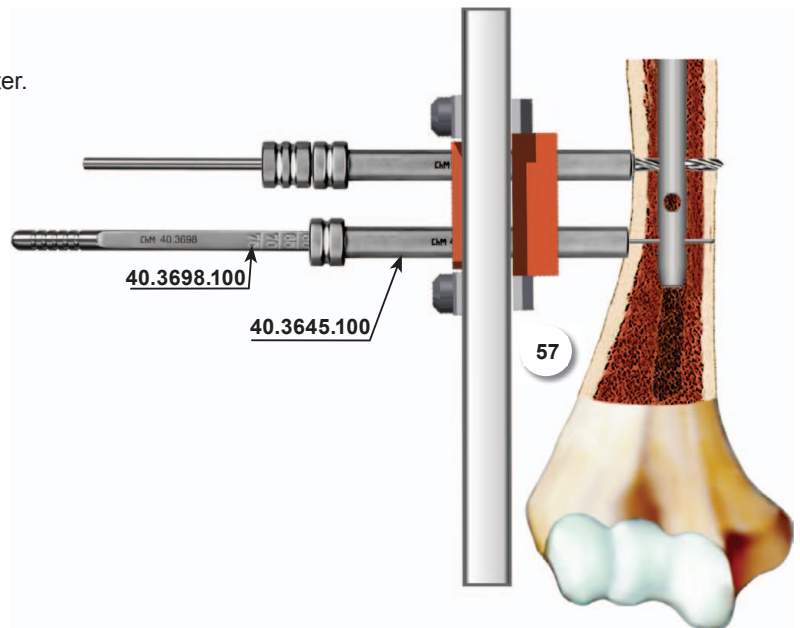

- 58 Insert the tip of the the Screwdriver [40.5031] into head of the definite locking screw. Then advance both into the Protective Guide [40.3645.100] and insert the locking screw in the prepared hole until the head of the screw reaches the cortex bone (the groove on the Screwdriver shaft matches the edge of the Protective Guide).

Remove the Screwdriver.

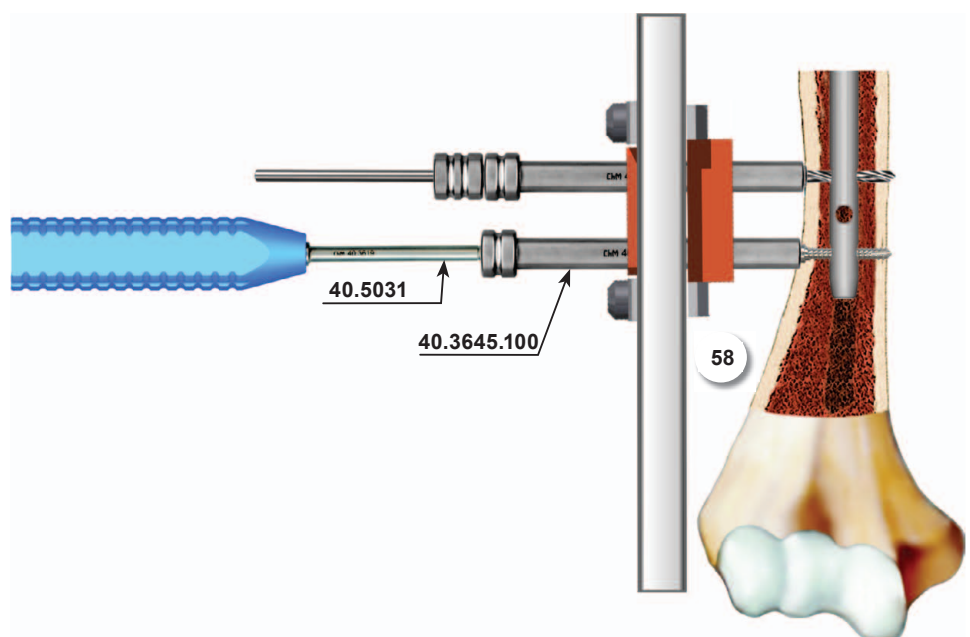

- 59 Insert the Screw Length Measure [40.3698.100] through the Protective Guide until its hook reaches the cortex on the other side of the bone. Read the length of the locking screw on the B-D scale.

During the measurement the end of the Protective Guide should rest on the cortex bone.

Remove Screw Length Measure.
Leave Protective Guide in the hole of the Targeter slider.

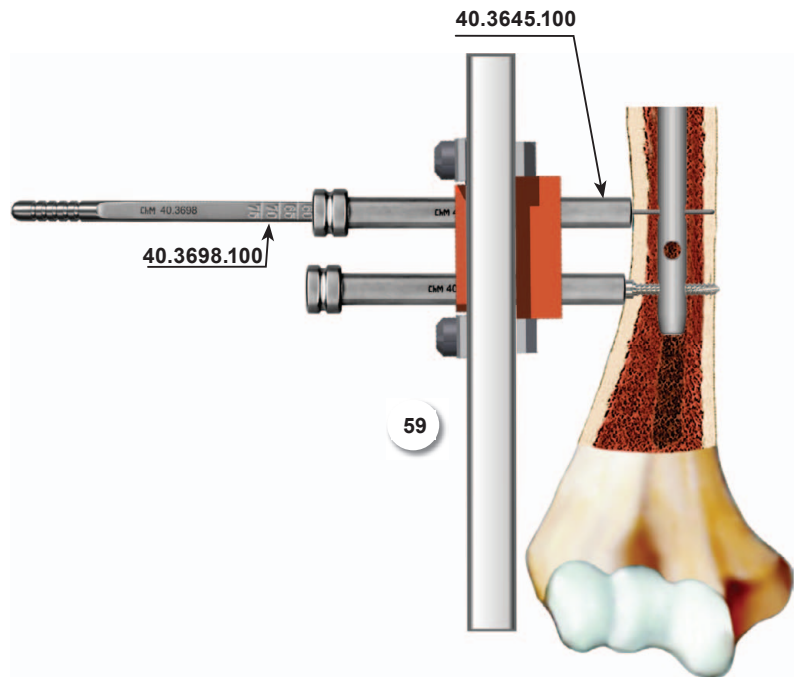

- 60 Insert the tip of the Screwdriver [40.5031] into the head of the definite locking screw. Then advance both into the Protective Guide [40.3645.100] and insert the locking screw in the prepared hole until the head of the screw reaches the cortex bone (the groove on the Screwdriver shaft matches the edge of the Protective Guide).

Remove the Screwdriver and Protective Guide.

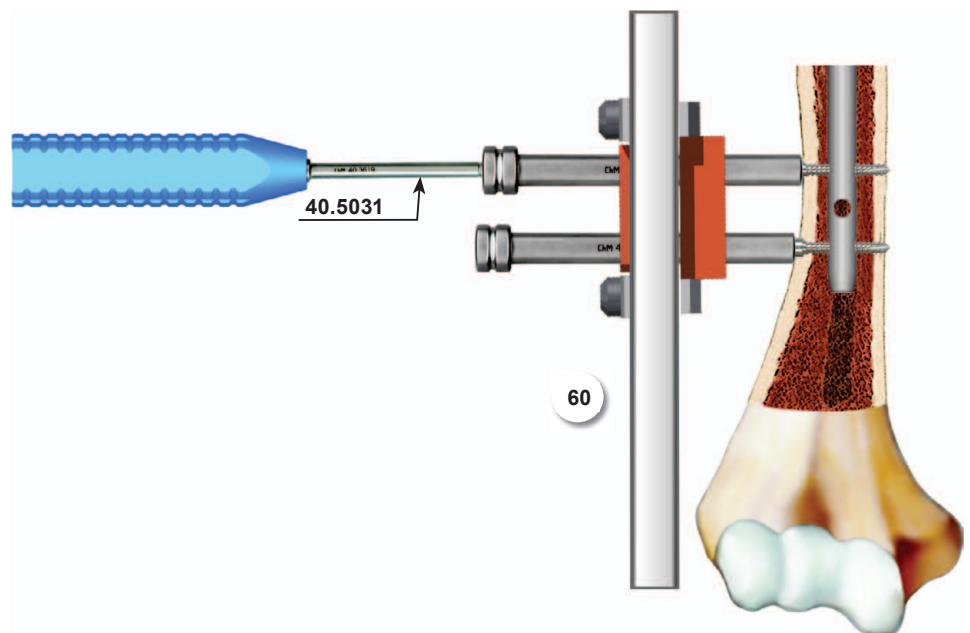

IV.13. PROXIMAL LOCKING OF LONG RECONSTRUCTION HUMERAL NAIL

In order to lock reconstruction humeral nail, it is necessary to mount the Angular targeter [40.5024] to the Humeral targeter B [40.5030] as showed in the picture. Insert threaded shaft (5) of the Angular targeter I (1) into lateral hole of the Humeral targeter B [40.5030] then into the connective hole of Angular targeter II (3). Connect parts by inserting the nut (4).

- 61 Using the Socket Wrench S 11 [40.3648] and the Connecting Screw [40.5023.100] mount the intramedullary nail to the leading sleeve of the Humeral targeter B [40.5030].

 Properly installed nail shall be positioned parallel to the arm of targeter B.

- 62 Connect the Impactor-Extractor [40.3665] to the installed system (attach to the threaded tip of the Humeral targeter B leading sleeve [40.5030]).

- 63 Insert the Protective Guide [40.3645.100] with the Trocar 6.5 [40.3647] into one of the holes I, II, III or IV in the Angular targeter [40.5024]. Mark on the skin the entry point on the skin for the locking screw, make an adequate incision through soft tissues approx. 1.5cm in length. Advance the Protective Guide together with the Trocar so as to put its end as close to cortex as possible and mark the entry point for the Drill.

Remove the Trocar.
Leave the Protective Guide in the hole of the targeter.

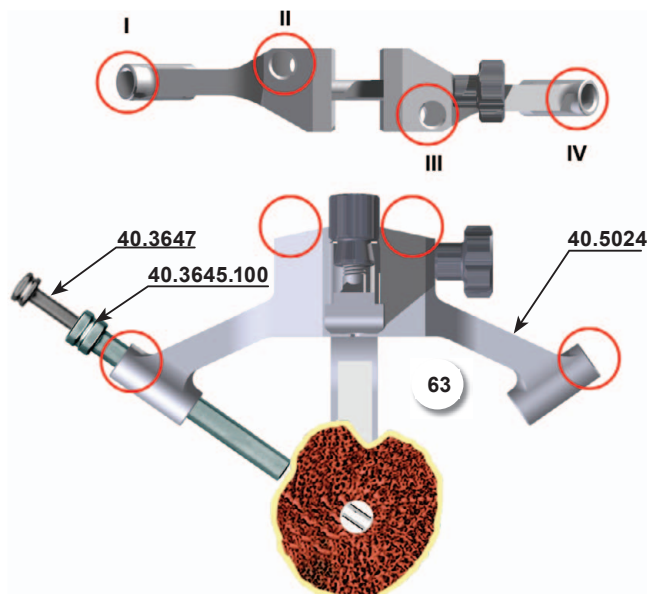
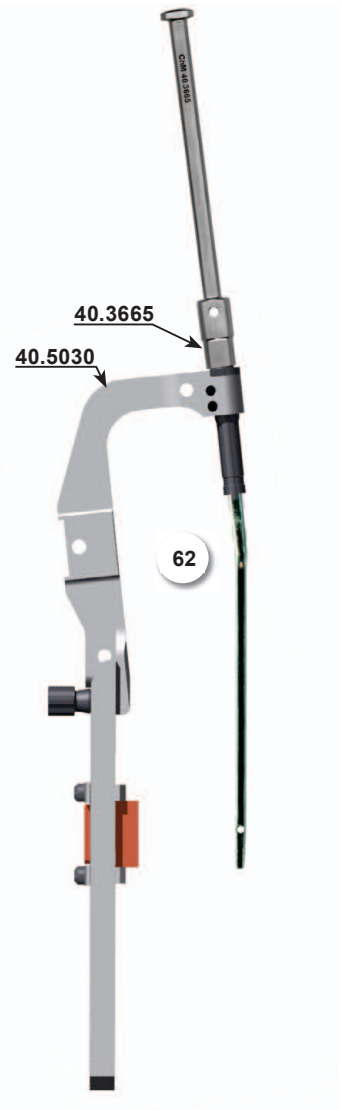
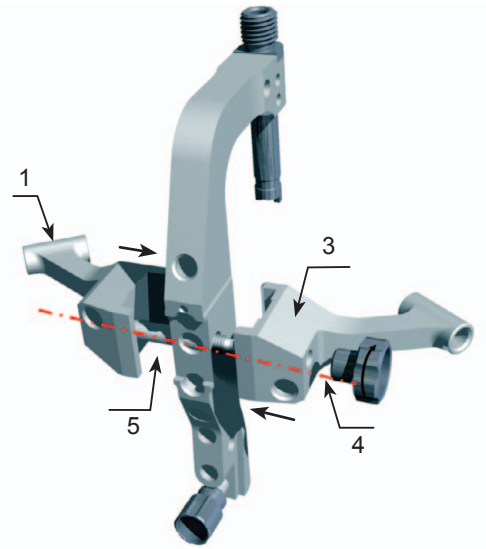

- 64 Insert the Drill Guide 6.5/3.5 [40.3646.100] into the Protective Guide [40.3645.100]. Mount the Drill 3.5/240 [40.5331.001] on the surgical drive and advance it through the Drill Guide. Drill the hole for locking screw under the X-Ray control.

Leave the Protective Guide with the Drill and the Drill Guide in the hole of the Humeral targeter B [40.5030].

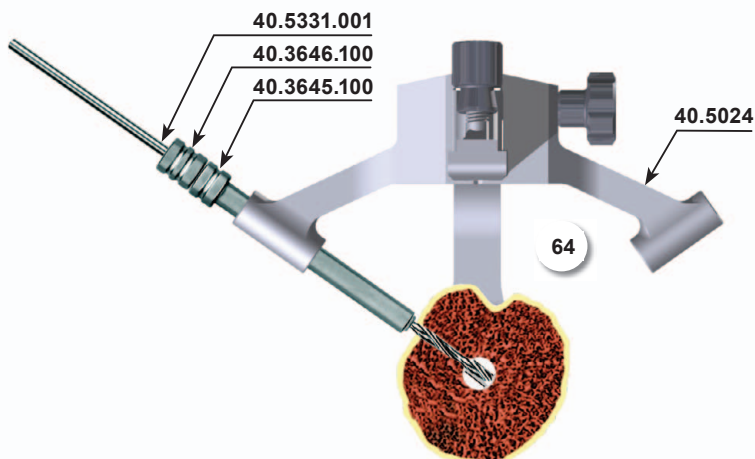

- 65 Insert the Protective Guide [40.3645.100] with the Trocar 6.5 [40.3647] into the next hole of the Angular targeter [40.5024]. Mark on the skin the entry point for the locking screw and make the adequate incision through the soft tissues approx. 1.5cm in length. Insert the Protective Guide together with the Trocar so its end rests on the cortex and mark the entry point for the Drill.

Remove the Trocar.
Leave the Protective Guide in the hole of the Targeter.

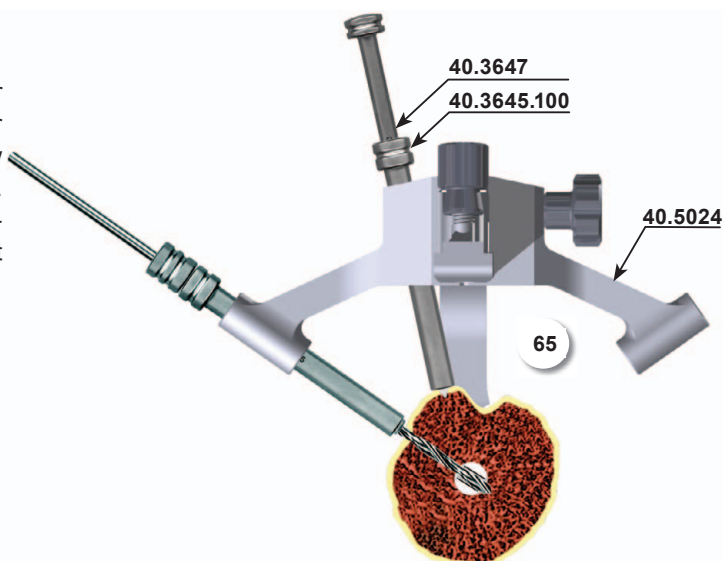

- 66 In case of nail locking by Locking Screws 4.5 [1.1653.xxx] use the Drill With Scale 4.5/240 [40.5336.001] to ream the hole in the first bone cortex (first: insert the Drill Guide 6.5/4.5 [40.3697.100] into the Protective Guide 9.0/6.5 [40.3645.100]).

Remove the Drill and the Drill guide.
Leave the Protective Guide in the hole of the Targeter.

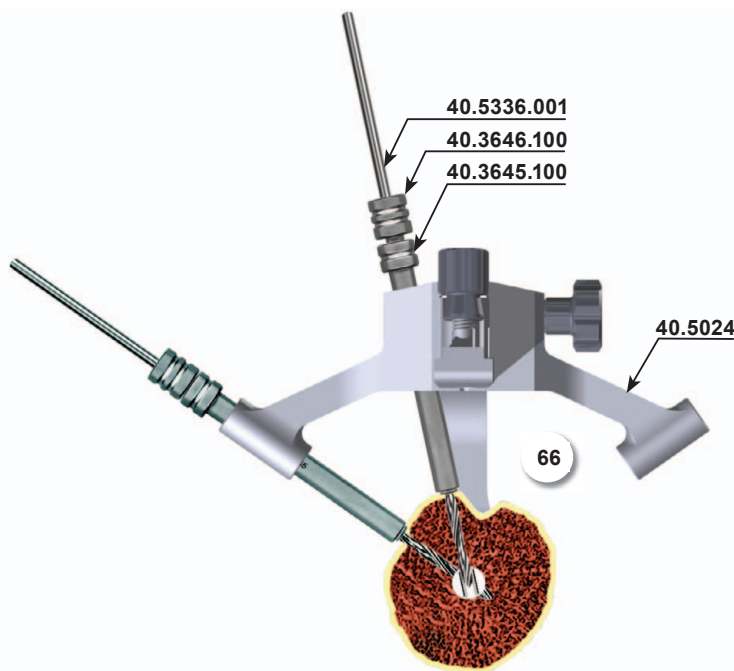

67 Insert the Drill Guide 6.5/4.5 [40.3697.100] into the Protective Guide [40.3645.100]. Advance the Drill With Scale 4.5/240 [40.5336.001] through the Drill Guide and widen the hole in the first bone cortex.

Remove the Drill and the Drill Guide.
Leave the Protective Guide in the hole of the Targeter.

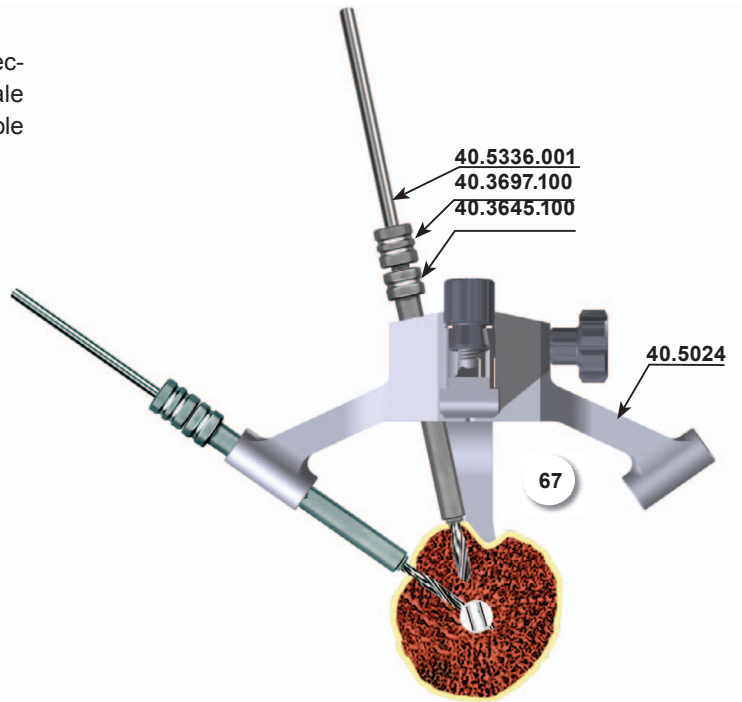

68 Remove the Drill [40.5331.001] and the Drill Guide 6.5/3.5 [40.3646.100] from the proximal hole of the Targeter. Leave in hole the Protective Guide [40.3645.100]. Insert the Screw Length Measure [40.3698.100] through the Protective Guide [40.3645.100] into the drilled hole until its tip reaches the end of the hole. Read the length of the locking screw on B-D scale. During the measurement the end of the Protective Guide should rest on the cortex bone.

Remove the Screw Length Measure.
Leave the Protective Guide in hole of the Targeter.

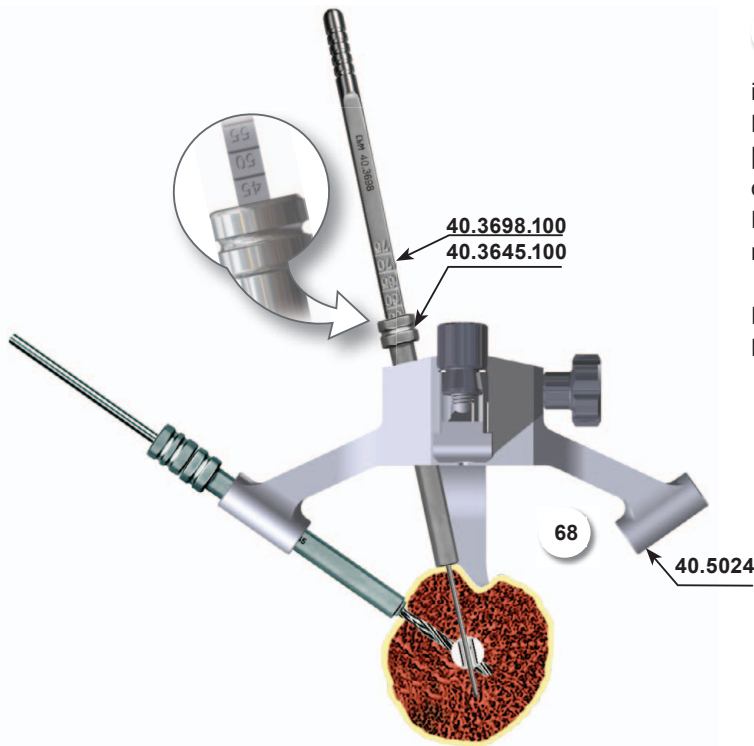

69 Insert the tip of the the Screwdriver [40.5031] into the socket of locking screw:

- 4.5 [1.1653] in case of standard locking; or
- 5.0 [1.1657] in case of locking in threaded hole of the nail.

Then insert both into the Protective Guide [40.3645.100] and carefully screw the locking screw in the prepared hole (until the groove on the Screwdriver shaft matches the edge of the Protective Guide).

Remove the Screwdriver.
Leave the Protective Guide.

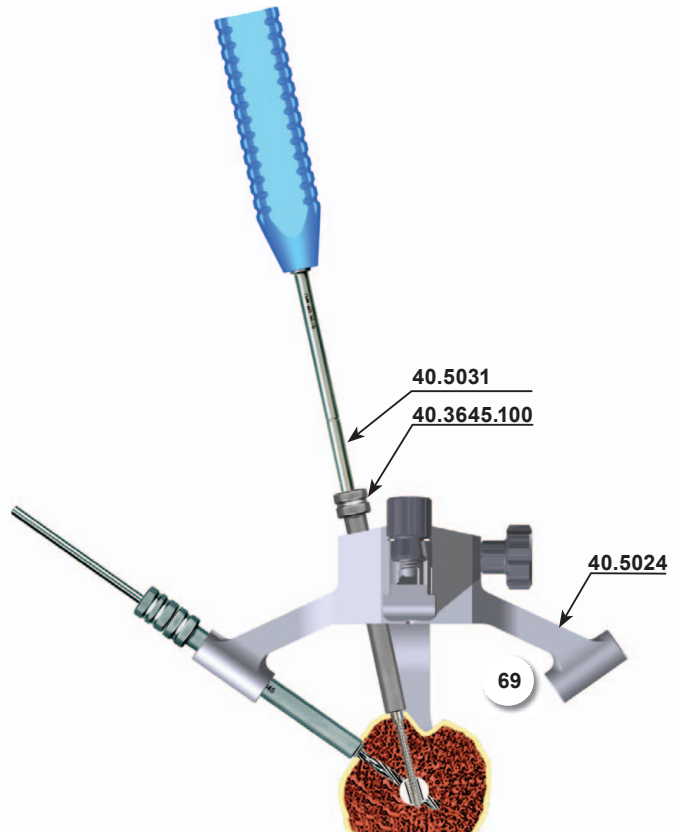

70 Remove the Drill Guide 6.5/3.5 [40.3646.100] and the Drill With Scale 3.5/240 [40.5331.001] from the first hole. Leave the Protective Guide. Insert the Drill Guide 6.5/4.5 [40.3697.100] into Protective Guide. Advance the Drill With Scale 4.5/240 [40.5336.001] into the Protective Guide to widen hole in the first cortex layer.

Remove the Drill and the Drill Guide.
Leave the Protective Guide in the Targeter hole.

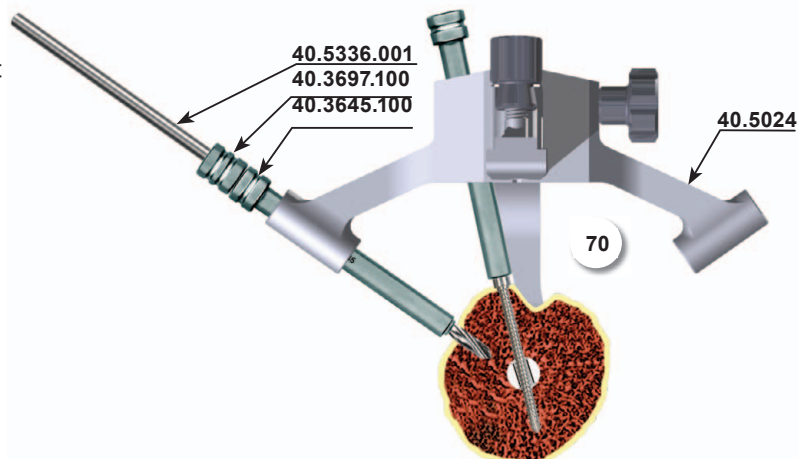

71 Remove the Drill With Scale 3.5/240 [40.5331.001] and the Drill Guide 6.5/3.5 [40.3646.100] from the proximal hole of the Targeter. Leave in hole the Protective Guide [40.3645.100]. Insert the Screw Length Measure [40.3698.100] through the Protective Guide [40.3645.100] into the drilled hole until its tip reaches the end of the hole. Read the length of the locking screw on B-D scale.

Remove the Screw Length Measure.
Leave the Protective Guide in hole of the Targeter.

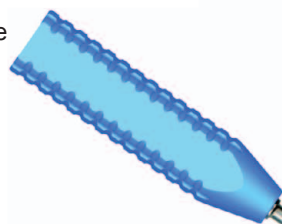
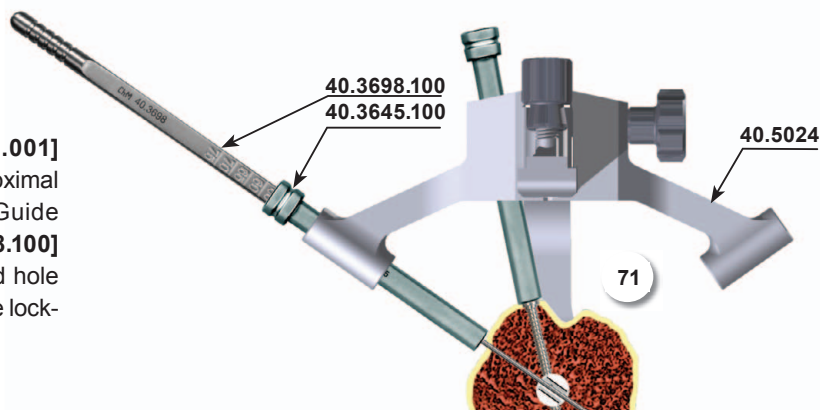

72 Insert the tip of the the Screwdriver [40.5031] into the socket of locking screw:
- 4.5 [1.1653] in case of standard locking; or
- 5.0 [1.1657] in case of locking in threaded hole of the nail.

Then advance both into the Protective Guide [40.3645.100] and carefully insert the locking screw in the prepared hole (until the groove on the Screwdriver shaft matches the edge of the Protective Guide).

Remove the Screwdriver and Protective Guide.

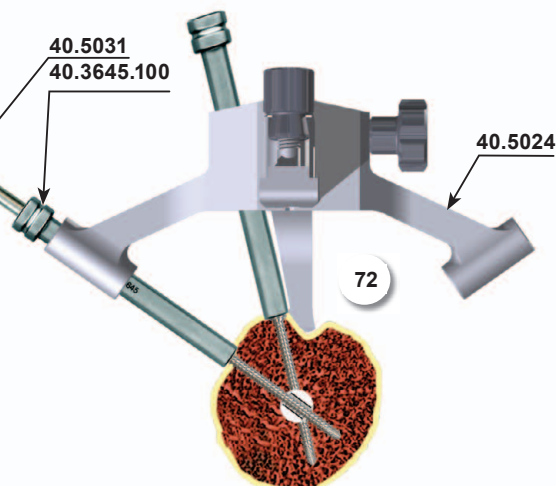

In order to enable locking the nail in other proximal holes, it is recommended (after drilling the first hole and checking the correctness of the process) to leave the Drill in the hole and start locking the rest of holes or the nail, and to leave the Protective Guide on the head of locking screw in order to improve the stability of the system: nail – Targeter.

IV.14. DISTAL LOCKING OF THE NAIL BY “FREEHAND” TECHNIQUE

With this technique an image intensifier is used to identify the entry points for the Drill and to control the drilling process. It is recommended to use angular attachment with the surgical drive while drilling the holes, so that surgeon's hands are not directly exposed to X-Rays. After marking the entry points on the skin, incisions are made in the marked places through the soft tissues, each about 1.5cm in length.

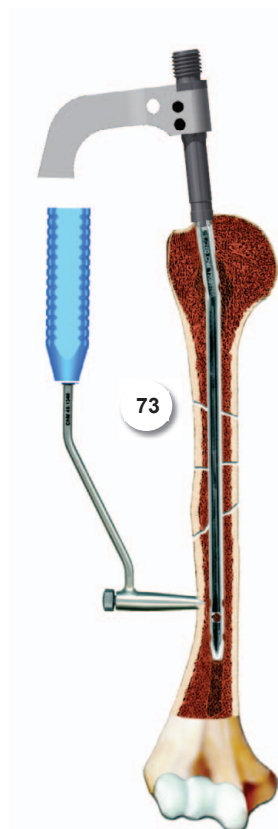

- 73 Using X-Ray camera place the Targeter D [40.1344] in line to the nail hole. The centers of the holes in the Targeter and the nail have to match. The teeth of the Targeter have to be sink into the cortex. Insert the Short Trocar [40.1354] into the hole in the Targeter D, advance it until it reaches the cortex and mark the entry point for the Drill.

Remove the Trocar.
Leave the Targeter D in place.

- 74 Drill the hole for locking screw insertion.

OPTION I

Implantation 8 or 9 mm nails (with the use of 4.5 screws).

Insert the Drill Guide Short 7/3.5 [40.1358] into the Targeter D [40.1344]. Lead 3.5/240 Drill [40.5331.001] in Drill Guide, drill the hole in the humerus through both cortex layers.

OPTION II

Implantation 6 or 7 mm nails (with the use of 3.5 screws).

Insert the Drill Guide 7/2.8 [40.3670] into the Targeter D [40.1344]. Advance the Drill With Scale 2.8/240 [40.5332.001] in Drill Guide, drill the hole in the humerus through both cortex layers.

Remove the Drill and Drill Guide.
Leave the Targeter D.

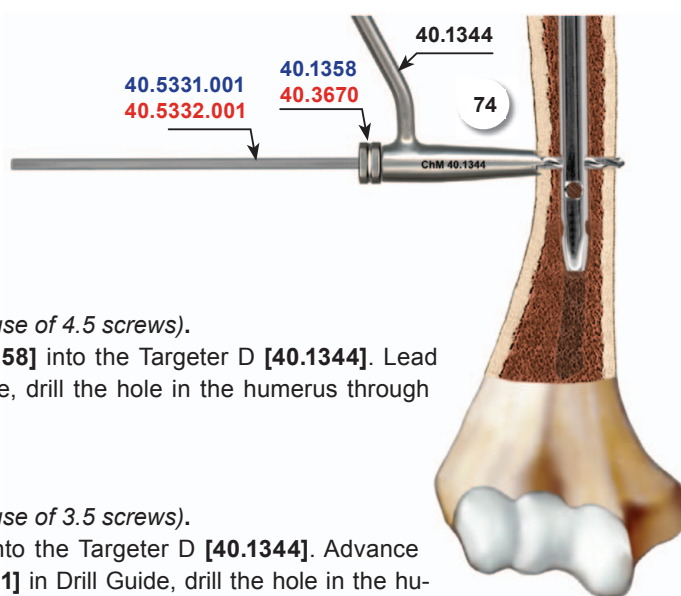

- 75 Insert the Screw Length Measure [40.3698.100] through the hole of the Targeter D [40.1344] into the drilled hole until its hook reaches the cortex on the other side of the bone. Read the length of the locking screw on the scale D.

Remove the Screw Length Measure.
Leave the Targeter D in place.

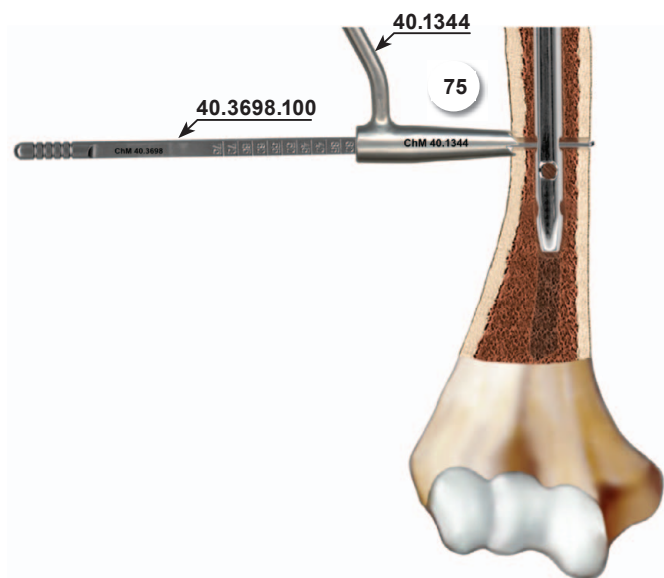

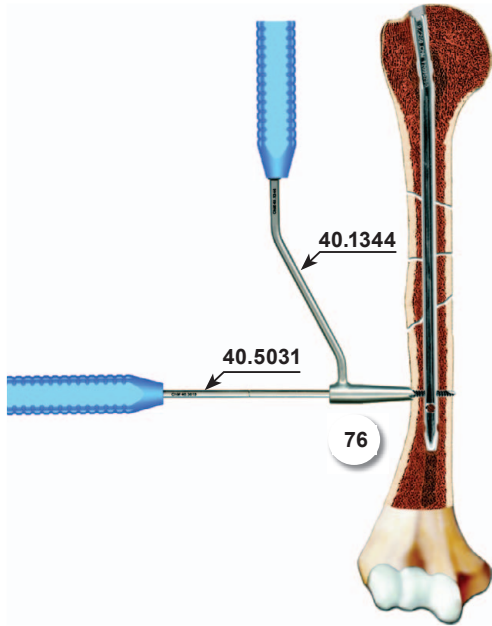

- 76 Insert the tip of the Screwdriver [40.5031] into the socket of the defined locking screw. Then advance such system into the hole in the Targeter D [40.1344] and insert the locking screw into the prepared hole until the head of the screw reaches the cortex bone.

Remove the Screwdriver and the Targeter D.



In order to lock the nail in the second distal hole repeat the steps 73 to 76.

IV.15. NAIL EXTRACTION

- 77 Use the the Screwdriver [40.5031] to remove the End Cap or the Compression Screw from the nail shaft. Using the Socket Wrench S 11 [40.3648] insert the Connector M7/M16 [40.4751] into the threaded hole in the nail.

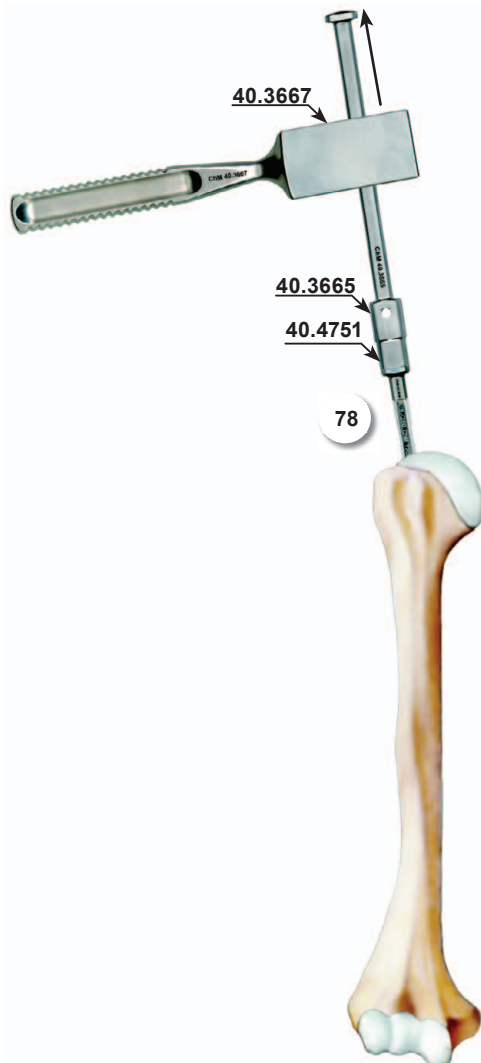

- 78 Using the Screwdriver unscrew all the locking screws. Attach the Extractor-Impactor [40.3665] to the Connector and using the Mallet [40.3667] extract the nail from the medullary canal.

IV.16. DISTAL NAIL INSERTION INTO THE MEDULLARY CANAL

Medullary canal opening for nail insertion.

After defining the entry point for nail implantation, make incision through the soft tissues. Using Cannulated Awl (*not included in ChM Instrument set*) perforate the cortex bone and open the medullary canal. Depending on the equipment in the operating theatre, the surgeon may use a different way of opening the medullary canal.

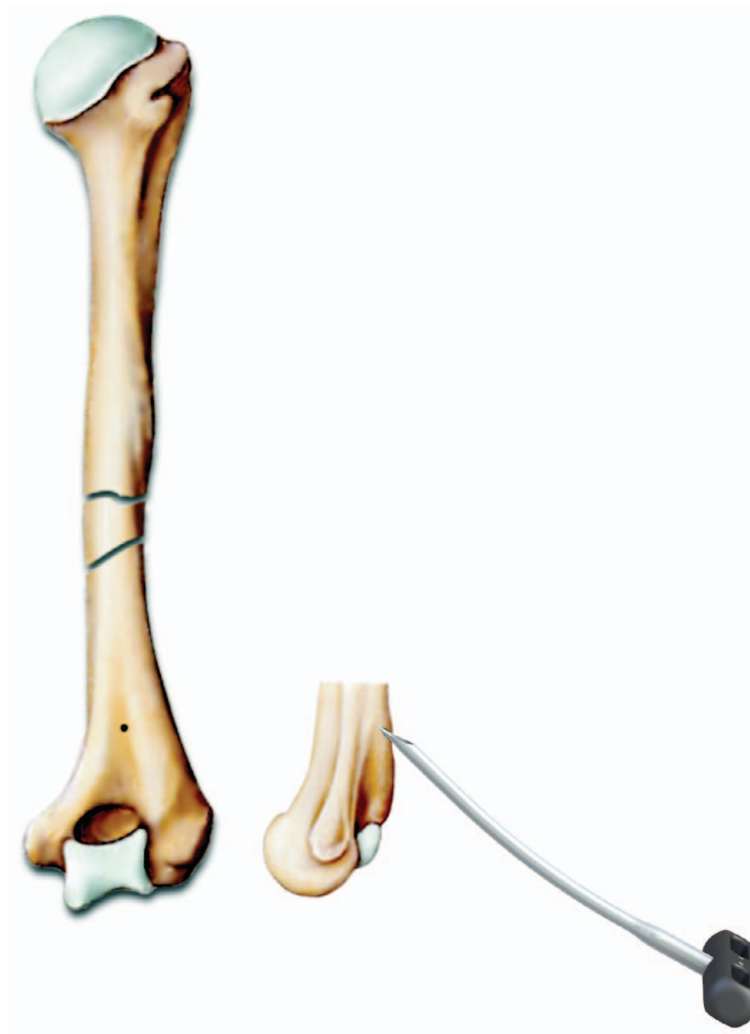

In order to prepare the medullary canal for nail implantation from the distal part and further activities concerning osteosynthesis of humerus, the technique of implantation from proximal part should be applied, as described in steps 10-26.



GB

ChM®

ISO 9001/ ISO 13485



Manufacturer: ChM sp. z o.o. Lewickie 3b, 16-061 Juchnowiec K., Poland tel.: +48 85 713-13-20 fax: +48 85 713-13-19 e-mail: chm@chm.eu www.chm.eu

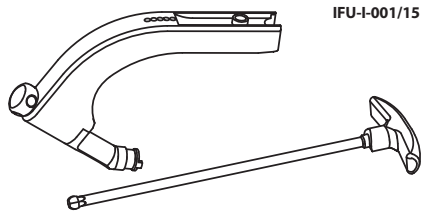

IFU-I-001/15

GB

INSTRUCTIONS FOR USE

REUSABLE ORTHOPAEDIC AND SURGICAL INSTRUMENTS



Instruments manufactured by ChM sp. z o.o. are made of steel, aluminium alloys and plastics according to ISO standards. Each medical instrument is exposed to occurrence of corrosion, stains and damage if not treated with special care and according to recommendations provided below.

MATERIALS

Devices are produced of corrosion-resistant steel. The protective layer (passive layer) against corrosion is formed on the surface of the steel due to high content of chromium.

Devices produced of aluminium are mainly stands, palettes, cuvettes and some parts of instruments such as handles of screwdrivers, awls or wrenches, etc. The protective oxide layer, which may be dyed or stay in natural colour (silvery-grey), is formed on the aluminium as an effect of electrochemical treatment on its surface.

Devices made of aluminium with processed layer have a good corrosion resistance. The contact with strong alkaline cleaning and disinfecting agents, solutions containing iodine or some metal salts, due to chemical interference on the processed aluminium surface, shall be avoided.

Devices are mainly manufactured out of the following plastics: POM-C (Polyoxymethylene Copolymer), PEEK (Polyetheretherketone) and teflon (PTFE). The above mentioned materials can be processed (washed, cleaned, sterilized) at temperatures not higher than 140°C, they are stable in aqueous solution of washing-disinfecting agents with pH values from 4 to 9.5.

If the material of the device cannot be specified, please contact ChM sp. z o.o. company representative.

DISINFECTION AND CLEANING

Effective cleaning is a complicated procedure depending on the following factors: the quality of water, the type and the quality of used detergent, the technique of cleaning (manual/machine), the correct rinsing and drying, the proper preparation of the instrument, the time, the temperature. Internal procedures of sterilization rooms, recommendations of cleaning and disinfecting agents, as well as recommendations for cleaning and sterilization in automatic machines shall be observed.

Read and follow the instructions and restrictions specified by the manufacturers of the agents used for disinfection and cleaning procedures.

1. Before the first use, the product has to be thoroughly washed in the warm water with washing-disinfecting detergent. It is important to follow the instructions and restrictions specified by the producer of those detergents. It is recommended to use water solutions of cleaning-disinfecting agents with a neutral pH.

2. After use, for at least 10 minutes the product has to be immediately soaked in an aqueous disinfectant solution of enzyme detergent with a neutral pH (with disinfecting properties) normally used for reusable medical devices (remember to prevent drying out of any organic remains on the product surface). Follow all the instructions specified by the producer of those enzyme detergents.

3. Carefully scrub/clean the surfaces and crevices of the product using a soft cloth without leaving threads, or brushes made of plastic, the nylon brushes are recommended. Do not use brushes made of metal, bristles or another damaging material as they can cause physical or chemical corrosion.

4. Next, thoroughly rinse the instrument under the warm running water, paying particular attention to rinse the slots carefully. Use nylon brushes making multiple moves back and forth on the surface of the product. It is recommended to rinse under demineralized water, in order to avoid water stains and corrosion caused by chlorides, found in the ordinary water, and to avoid forming the stains on the surface (e.g. anodized one). During the rinsing, manually remove the adherent remains.

5. Visually inspect the entire surface of the product to ensure that all contaminants are removed.

If there are any residues of human tissue or any other contamination, repeat all stages of the cleaning process.

6. Then, the instrument has to undergo a process of machine washing in the washer-disinfector (use washing-disinfecting agents recommended for reusable medical devices and instruments).

Procedure of washing with the washer-disinfector shall be performed according to internal hospital procedures, recommendations of the washing machine manufacturer, and instructions for use prepared by the washing-disinfecting agents manufacturer.

ATTENTION! The manufacturer does not recommend using any preservatives on surgi-

cal and orthopaedic devices.

STERILIZATION

Before each sterilization procedure and application, the device has to be controlled. The device is to be efficient, without toxic compounds like residues after disinfection and sterilization processes, without structure damage (cracks, fractures, bending, peeling). Remember that sterilization is not a substitute for cleaning process!

Devices manufactured out of plastics (PEEK, PTFE, POM-C) may be sterilized by any other available sterilization method validated in the centre but the sterilization temperature is not to be higher than 140°C.

Sterilization of surgical instruments shall be carried out using appropriate equipment and under the conditions that conform to applicable standards. It is recommended to sterilize in steam sterilizers where sterilizing agent is water vapour. Recommended parameters of the sterilization method:

- temperature: 134°C,
- pressure: 2 atm. of pressure above atmospheric (overpressure),
- minimum exposure time: 7 min,
- minimum drying time: 20 min.

Validated sterilization methods are allowed. Durability and strength of instruments to a considerable degree depend on how they are used. Careful usage consistent with intended use of the product protects it against damage and prolongs its life.

If this instruction appears unclear, please contact the manufacturer, who shall provide all required explanations.

Updated INSTRUCTIONS FOR USE are available on the following website: www.chm.eu

IFU-I-001/15; Date of verification: January 2015

SYMBOL TRANSLATION - OBJASNIENIA SYMBOLI - ТИРСНЕНИЕ СОЗНАЧЕНИЯ EXPLICACION DE LOS SIMBOLOS - SYMBOLERKLÄRUNG - SYMBOLY PŘEKLADY

Table with 3 columns and 4 rows of symbols and their translations in multiple languages.

Manufacturer: ChM sp. z o.o. Lewickie 3b, 16-061 Juchnowiec K., Poland tel.: +48 85 713-13-20 fax: +48 85 713-13-19 e-mail: chm@chm.eu www.chm.eu

ChM sp. z o.o.

Lewickie 3b
16-061 Juchnowiec Kościelny
Poland

tel. +48 85 713 13 20

fax +48 85 713 13 19

chm@chm.eu

www.chm.eu



CE 0197
ISO 9001
ISO 13485