

NARZĘDZIA CHIRURGICZNE
SURGICAL INSTRUMENTS



CHIRURGIA OGÓLNA / GENERAL SURGERY 7

TRZONKI.....	8
SCALPEL HANDLES	
PROWADNIKI DO PODWIĄZYWANIA.....	9
LIGATURE CONDUCTORS	
IGŁOTRZYMACZE.....	12
NEEDLE HOLDERS	
IGŁOTRZYMACZE Z UTWARDZANĄ WKŁADKĄ.....	17
NEEDLE HOLDERS WITH T/C JAWS	
NOŻYCZKI.....	21
SURGICAL SCISSORS	
NOŻYCZKI Z UTWARDZANYMI OSTRZAMI.....	34
SURGICAL SCISSORS WITH T/C EDGES	
NOŻYCZKI Z UTWARDZANYMI OSTRZAMI.....	35
SURGICAL SCISSORS WITH T/C EDGES	
NOŻYCZKI Z UTWARDZANYMI OSTRZAMI.....	36
SURGICAL SCISSORS WITH T/C EDGES	
NOŻYCZKI SUPERCUT.....	37
SUPERCUT SCISSORS	
PINCETY ANATOMICZNE.....	39
DRESSING FORCEPS	
PINCETY CHIRURGICZNE.....	41
SURGICAL FORCEPS	
PINCETY DO ODŁAMKÓW.....	46
SPLINTER FORCEPS	
PINCETY Z UTWARDZANĄ WKŁADKĄ.....	47
FORCEPS WITH T/C JAWS	
KLESZCZYKI.....	49
FORCEPS	
KLESZCZYKI JELITOWE.....	68
INTESTINAL AND TISSUE GRASPING FORCEPS	
KLESZCZYKI DO TKANEK I ORGANÓW.....	74
TISSUE AND ORGAN HOLDING FORCEPS	
KLESZCZYKI NACZYNIOWE.....	76
BLOOD VESSEL CLAMPS	
KULOCIĄGI.....	77
TENACULUM FORCEPS	
INSTRUMENTY DO ROZSZERZANIA NACZYŃ.....	79
VASCULAR DILATORS	
SONDY.....	80
DIRECTORS	
SONDY I ŁYŻECZKI DO KAMIENI.....	81
GALL STONE PROBES AND SCOOPS	
KLESZCZYKI DO KAMIENI.....	82
GALL STONE FORCEPS	
POZOSTAŁE KLESZCZYKI.....	85
OTHER FORCEPS	
KLESZCZYKI/ PENSETY DO KLIPSÓW.....	86
CLIP FORCEPS	
HAKI DO NERWÓW I NACZYŃ.....	87
NERVE- AND VESSEL HOOKS	
HAKI DO NERWÓW.....	88
NERVE HOOKS	
HAKI DO RAN I NERWÓW.....	89
WOUND AND NERVE HOOKS	

HAKI DO RAN I TCHAWICY.....	92
WOUND AND TRACHEA HOOKS	
HAKI, HAKI DO RAN I ŻYŁ.....	94
WOUND-, VEIN- RETRACTORS	
HAKI.....	95
RETRACTORS	
HAKI, HAKI KOSTNE.....	96
RETRACTORS, BONE RETRACTORS	
HAKI.....	99
RETRACTORS	
HAKI, HAKI KOSTNE.....	103
RETRACTORS, BONE RETRACTORS	
HAKI.....	104
RETRACTORS.....	104
HAKI, ŁOPATKI DO PŁUCA.....	118
RETRACTORS, LUNG SPATULAS	
HAKI.....	121
RETRACTORS	
ŁOPATKI DO BRZUCHA I JELIT.....	124
ABDOMINAL AND INTESTINAL SPATULAS	
ROZWIERACZE.....	126
RETRACTORS	
ROZWIERACZE BRZUSZNE.....	133
ABDOMINAL RETRACTORS	

GINEKOLOGIA / GYNECOLOGY 143

KLESZCZYKI GINEKOLOGICZNE.....	144
GYNECOLOGICAL FORCEPS	
KLESZCZYKI DO BIOPSI.....	148
BIOPSY PUNCHES	
WZIERNIK GINEKOLOGICZNY.....	149
VAGINAL SPECULA	
ENDOWZIERNIKI.....	153
ENDOSPECULA	
ROZSZERZACZE SZYJKI MACICY.....	154
UTERINE DILATORS	
ROZSZERZACZE GINEKOLOGICZNE.....	155
UTERINE DILATORS	
SONDY/ ŁYŻECZKI GINEKOLOGICZNE.....	156
UTERINE SOUNDS/ CURETTES	
ŁYŻECZKI GINEKOLOGICZNE.....	157
UTERINE CURETTES	
KLESZCZYKI GINEKOLOGICZNE DO POLIPÓW.....	161
UTERINE POLYPUS FORCEPS	
KLESZCZYKI GINEKOLOGICZNE.....	162
VAGINAL FORCEPS	

INNE / OTHERS 164

TACE/ POJEMNIKI DO STERYLIZACJI.....	
STERILIZING CONTAINERS/ TRAYS	
POJEMNIKI METALOWE.....	169
TINWARE	
INDEX.....	170
INDEX	

40 lat doświadczenia

40 lat doświadczenia

Historia marki sięga roku 1981, kiedy przez Mikołaja Charkiewicza zostaje powołana do życia firma ChM. W roku 1985 rozpoczęto prace związane z produkcją prostych narzędzi chirurgicznych, a rok później, w 1986 r., powołano biuro projektowe, którego zadaniem było opracowywanie konstrukcji i technologii wytwarzania wyrobów stosowanych w ortopedii i traumatologii. Choć dostępna w tym czasie w Polsce wiedza na temat materiałów, technologii czy funkcjonowania narzędzi medycznych była bardzo ograniczona, już na początku lat 90-tych firma rozpoczęła produkcję pierwszych prostych implantów metalowych. W roku 2004 firma przekształciła się w jednostkę z osobowością prawną pod nazwą ChM spółka z ograniczoną odpowiedzialnością.

Obecny sukces firmy zawdzięczamy początkowym ograniczeniom. To one stały się przyczynkiem do ciągłych poszukiwań, samokształcenia oraz tworzenia własnej bazy badawczej. Dzisiejsza współpraca obejmuje zarówno środowisko medyczne jak i instytucje badawcze w kraju i zagranicą. 40 lat doświadczeń nauczyło nas słuchać i reagować na potrzeby dynamicznie rozwijającej się medycyny. Cały ten okres to rozwój oparty na relacjach wzajemnego zaufania. To właśnie dzięki nim możemy rozbudowywać portfolio naszych produktów.

Oferowane przez nas narzędzia to najwyższej jakości wyroby medyczne, wytwarzane zgodnie z obowiązującą wersją norm EN ISO 9001:2015 oraz EN ISO 13485:2016 i zgodnie z Dyrektywą 93/42/EEC dotyczącą produktów medycznych.

Narzędzia są w specjalny sposób oznakowane kodem DATAMATRIX. Zapewnia to:

- monitorowanie miejsca znajdowania się danego narzędzia
- śledzenie narzędzia na drodze szpital-sterylizatornia
- zawarcie pełnej informacji o wyrobie na małej powierzchni
- oszczędność czasu przy organizacji pracy szpitala.

40 years of experience

The history of the brand dates back to 1981, when Mr. Mikołaj Charkiewicz established the ChM company. In 1985 the production of first simple surgical instruments had started and a year after, in 1986, the design department was created. Its main task was to develop the design and manufacture technology of products used in orthopedics and traumatology. Although the available knowledge about materials, technology or functioning of medical tools was limited back then in Poland, the production of first simple metal implants was started in the beginning of the 1990s. In 2004, the company transformed into the ChM limited liability company.

We owe this success of the company to the initial limitations. These limitations contributed to constant search, self-education and creation of own research base. Today's cooperation incorporates both medical environment and research institutions in the country and abroad. 40 years of experience has taught us to listen and respond to the needs of dynamically developing medicine. This whole period was a time of development based on mutual trust. Thanks to this kind of relationship we are able to expand our product portfolio by creating a new solution.

The instruments we offer are medical devices of the highest quality manufactured in accordance with the applicable version of EN ISO 9001:2015 and EN ISO 13485:2016 and in accordance with Directive 93/42/EEC concerning medical products. Our instruments are marked in a special way with DATAMATRIX code. The code provides:

- monitoring of a particular instrument's location
- tracking an instrument on the hospital - sterilization path
- providing full information about a product on a small area
- saving time in the organization of hospital work.





Nr 3	Nr 3L	Nr 3L	Nr 4	Nr 4L	Nr 4L	Nr 7
30.0041	30.0042	30.0098	30.0043	30.0044	30.0099	30.0046
125 mm	210 mm	210 mm	135 mm	220 mm	220 mm	160 mm

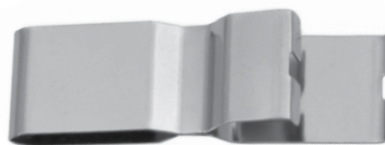

30.4350

Uchwyt do zdejmowania ostrza
Scalpel blade remover

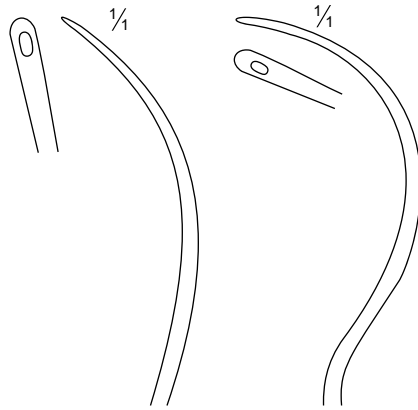

30.4160

30.4161

Brunner
300 mm

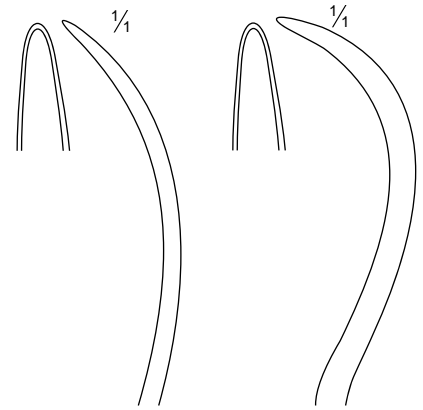

30.4162

30.4163

Brunner
300 mm

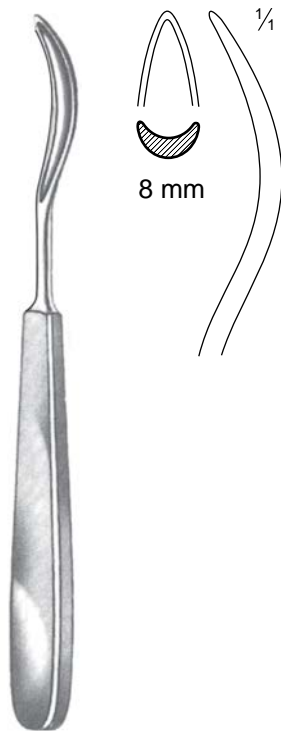

Schmieden
30.4164
190 mm

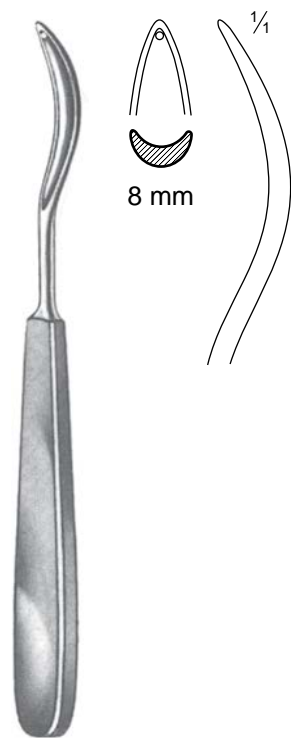

Schmieden-Payr
30.4165
190 mm



König
30.4166
195 mm

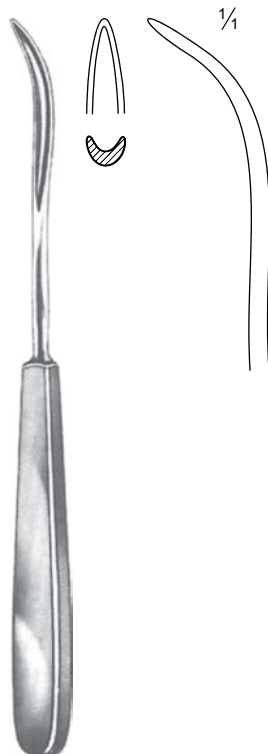

König
30.4167
195 mm

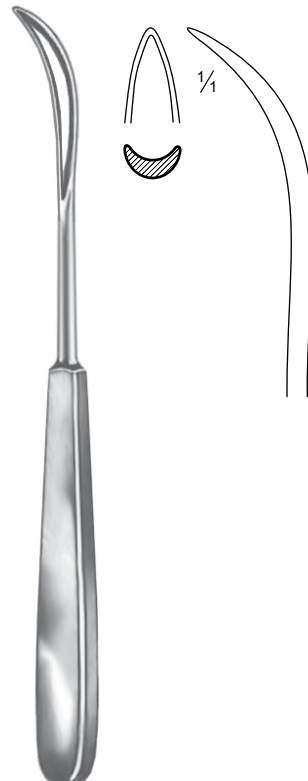

König
30.4168
200 mm



Payr
30.4184
220 mm

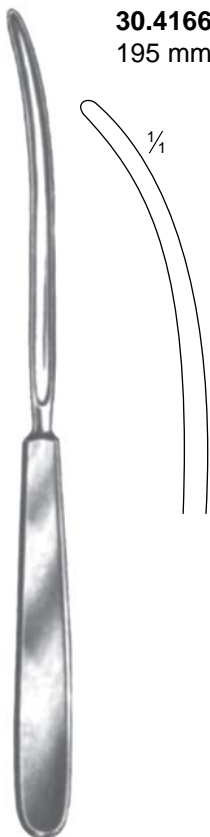

Payr
30.4185
220 mm



30.4186
195 mm



Kocher

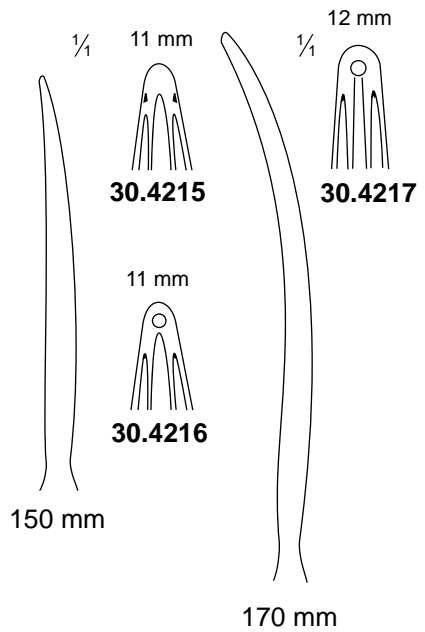

30.4215

30.4216

30.4217

150 mm

170 mm



Reverdin
140 mm



30.4187



30.4188



30.4189



30.4190



Reverdin



30.4191
195 mm



30.4192
195 mm



30.4193
195 mm



30.4194
195 mm



30.4195
225 mm



30.4196
225 mm



30.4197
225 mm



30.4198
225 mm



Mayo-Hegar

30.2700	140 mm	
30.2701	160 mm	30.2706
30.2702	180 mm	30.2707
30.2703	200 mm	30.2708
30.2704	240 mm	30.2709
30.2705	260 mm	30.2710

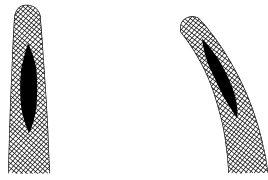

Mayo-Hegar

30.2711	160 mm
30.2712	180 mm
30.2713	200 mm

delikatne
slender
деликатные

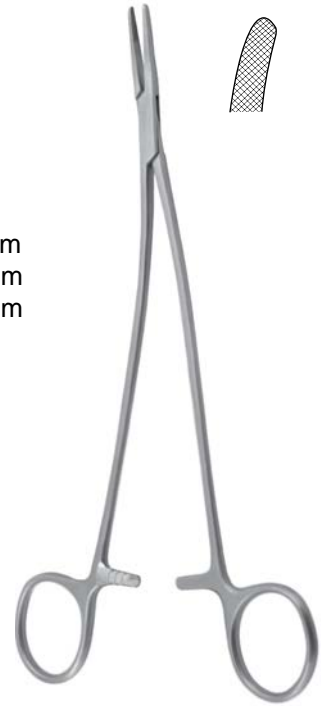

Stratte

30.2714
230 mm

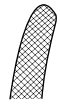

Halsey
130 mm

30.2715	30.2716
----------------	----------------

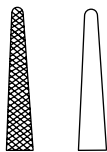

Crile-Wood
150 mm

30.2717	30.2718
----------------	----------------

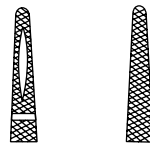

Webster
30.2719
130 mm





Collier
30.2720
125 mm



M.G.H
30.2721
170 mm



Sarot
30.2722 180 mm
30.2723 260 mm



Derf
125 mm



Brown
30.2730 130 mm
30.2731 180 mm

igłotrzymacze z nożyczkami • needle holders with scissors • иглодержатели с ножницами

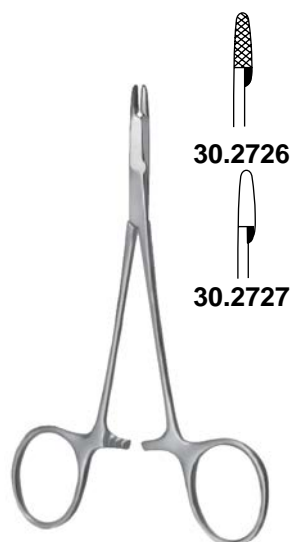

Baby-Olsen-Hegar

115 mm



Olsen-Hegar

30.2728
140 mm



Gillies

30.2729
160 mm

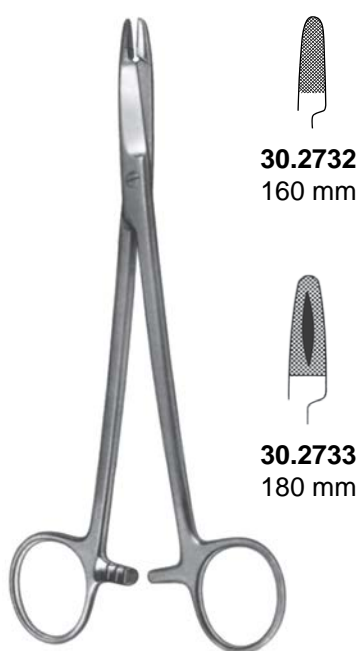

Olsen-Hegar

30.2732
160 mm

30.2733
180 mm



Olsen-Hegar

30.2680
140 mm



Olsen-Hegar

30.2681
170 mm



30.2734 150 mm
30.2735 180 mm
30.2736 200 mm
30.2737 230 mm

Crile-Wood



30.2738
180 mm

Adson



30.2739
150 mm

Crile



Heaney
30.2740 210 mm
30.2741 260 mm

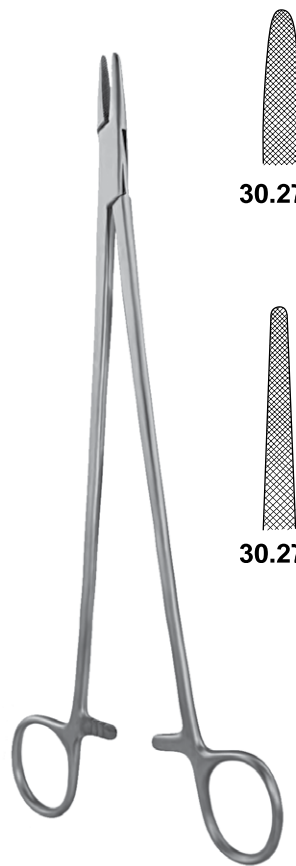

30.2742

30.2743

Wangenstein
270 mm



Finochietto
30.2744
270 mm



Masson
30.2745
270 mm



30.2746 170 mm
30.2747 200 mm



30.2748 170 mm
30.2749 200 mm

Mathieu



30.2750 140 mm **30.2753**
30.2751 170 mm **30.2754**
30.2752 200 mm **30.2755**



30.2756 140 mm
30.2757 170 mm

Mathieu



Hegar-Baum
30.2758
140 mm

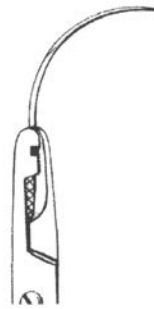

Ermold
30.2683
170 mm



Jameson
30.2684
230 mm



- 30.2759** 130 mm 1,2 mm
- 30.2760** 145 mm 1,4 mm
- 30.2761** 160 mm 1,5 mm
- 30.2762** 180 mm 1,7 mm
- 30.2763** 200 mm 2,0 mm
- 30.2764** 230 mm 2,2 mm
- 30.2765** 260 mm 2,4 mm

French



- 30.2766** 140 mm
- 30.2767** 160 mm
- 30.2768** 180 mm
- 30.2769** 200 mm
- 30.2770** 230 mm
- 30.2771** 260 mm
- 30.2690** 180 mm
- 30.2691** 200 mm
- 30.2692** 230 mm
- 30.2693** 260 mm

Mayo-Hegar



30.2772

30.2773

Halsey

130 mm



30.2774

Webster

130 mm



30.2775

Mayo-Hegar

300 mm

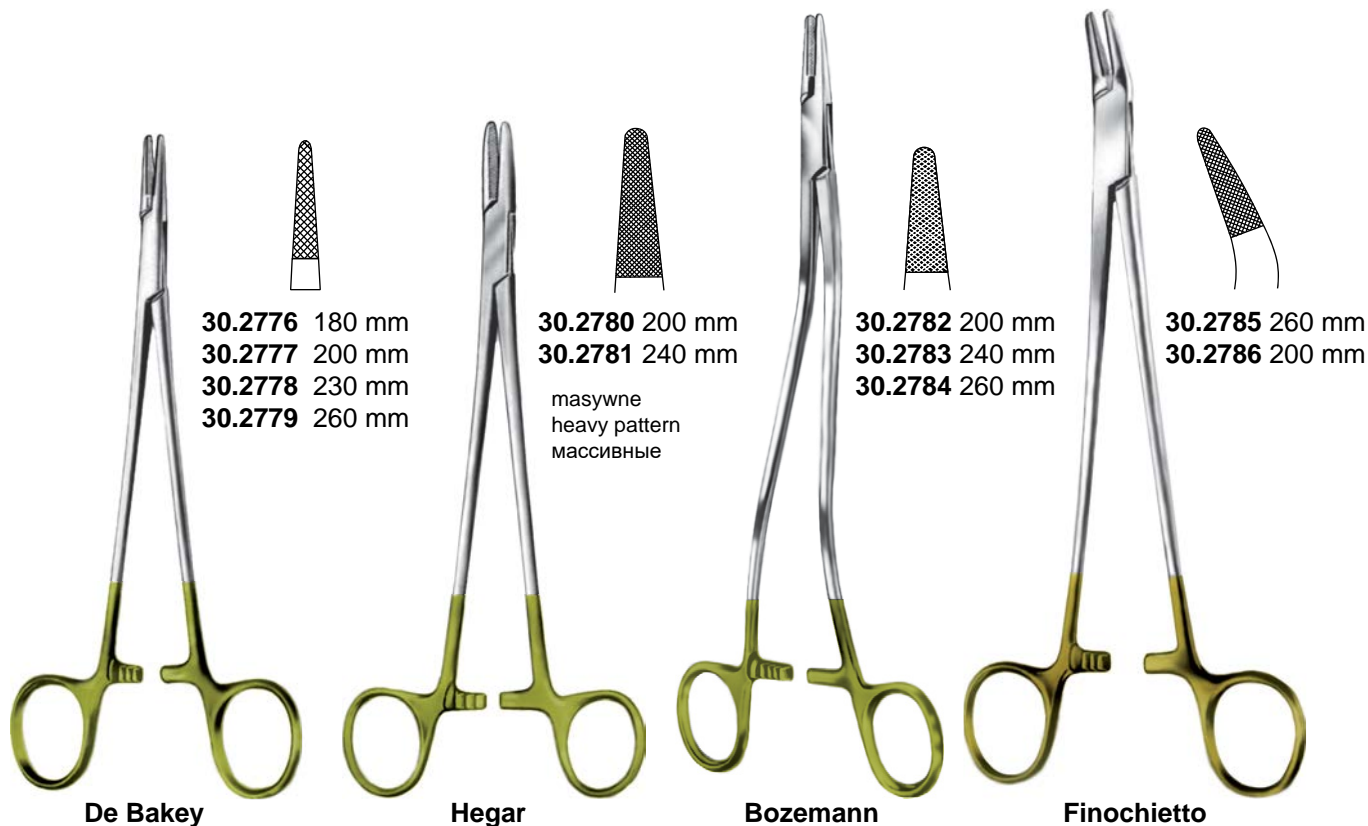



- 30.2795** 150 mm
- 30.2796** 180 mm
- 30.2797** 200 mm
- 30.2798** 230 mm
- 30.2799** 260 mm

Crile-Wood



Olsen- Mathieu

- 30.2694** 140 mm



Olsen- Mathieu

- 30.2695** 170 mm
- 30.2696** 200 mm



Mathieu

- 30.2800** 170 mm
- 30.2801** 200 mm



- 30.2802** 170 mm
- 30.2803** 200 mm

masywne
heavy pattern
массивные

Mathieu



- 30.2804** 140 mm
- 30.2805** 170 mm
- 30.2806** 200 mm

Mathieu



- 30.2807** 140 mm
- 30.2808** 170 mm
- 30.2809** 200 mm

Mathieu



- 30.2810** 140 mm
- 30.2811** 170 mm
- 30.2812** 200 mm

French- Mathieu



Derf

30.2814
125 mm

Baumgartner

30.2815.000 130 mm
30.2815.140 140 mm

Heaney

30.2816 200 mm
30.2817 260 mm

Sarot

30.2818 180 mm
30.2819 200 mm
30.2820 260 mm



Masson

30.2821
270 mm



Baby-Olsen-Hegar

30.2822 115 mm
30.2823 115 mm



Castroviejo

30.2685.140 140 mm
30.2685.180 180 mm
30.2685.220 220 mm

30.2686.140
30.2686.180
30.2686.220

30.2687.140 140 mm
30.2688.140

30.2689.140 140 mm
30.2689.180 180 mm
bez zamka
without ratchet
без замка



30.0121	30.0130	30.0139	105 mm
30.0122	30.0131	30.0140	115 mm
30.0123	30.0132	30.0141	130 mm
30.0124	30.0133	30.0142	145 mm
30.0125	30.0134	30.0143	155 mm
30.0126	30.0135	30.0144	165 mm
30.0127	30.0136	30.0145	175 mm
30.0128	30.0137	30.0146	185 mm
30.0129	30.0138	30.0147	200 mm

Standard
 proste · straight · прямые

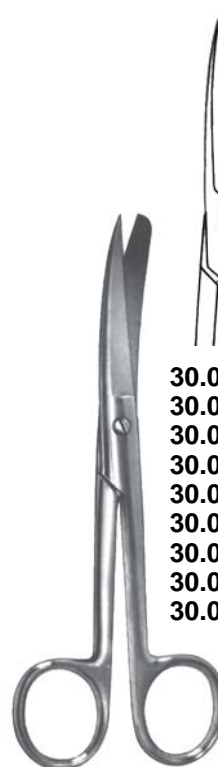

30.0148	30.0157	30.0166	105 mm
30.0149	30.0158	30.0167	115 mm
30.0150	30.0159	30.0168	130 mm
30.0151	30.0160	30.0169	145 mm
30.0152	30.0161	30.0170	155 mm
30.0153	30.0162	30.0171	165 mm
30.0154	30.0163	30.0172	175 mm
30.0155	30.0164	30.0173	185 mm
30.0156	30.0165	30.0174	200 mm

Standard
 odgięte · curved · изогнутые



30.2383	30.2384	30.2385	145 mm
30.0175	30.0181	30.0187	180 mm
30.0176	30.0182	30.0188	200 mm
30.0177	30.0183	30.0189	230 mm
30.0178	30.0184	30.0190	250 mm
30.0179	30.0185	30.0191	280 mm
30.0180	30.0186	30.0192	300 mm

Metzenbaum
 proste · straight · прямые



30.2386	30.2387	30.2388	145 mm
30.0193	30.0199	30.0205	180 mm
30.0194	30.0200	30.0206	200 mm
30.0195	30.0201	30.0207	230 mm
30.0196	30.0202	30.0208	250 mm
30.0197	30.0203	30.0209	280 mm
30.0198	30.0204	30.0210	300 mm

Metzenbaum
 odgięte · curved · изогнутые

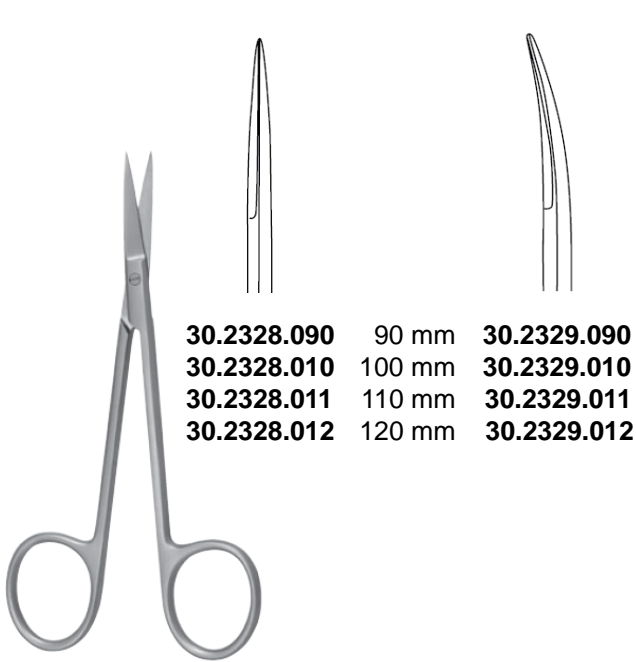

30.2328.090	90 mm	30.2329.090
30.2328.010	100 mm	30.2329.010
30.2328.011	110 mm	30.2329.011
30.2328.012	120 mm	30.2329.012



30.2331	150 mm	30.2335
30.2332	170 mm	30.2336
30.2333	230 mm	30.2337

Mayo

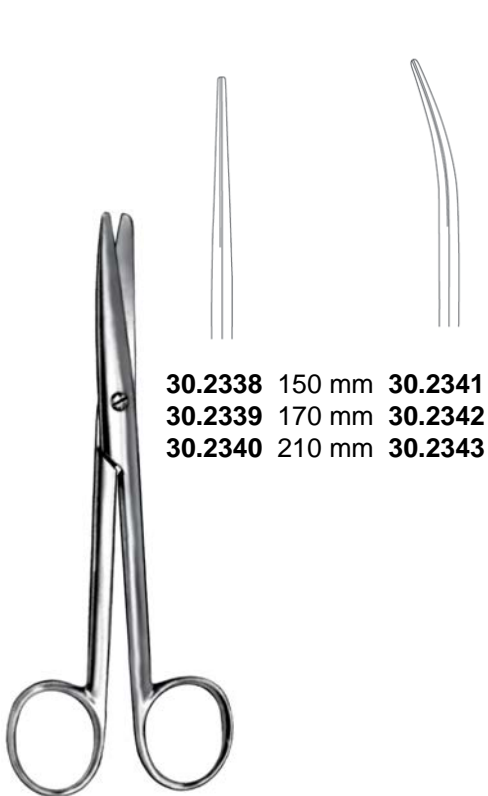

30.2338	150 mm	30.2341
30.2339	170 mm	30.2342
30.2340	210 mm	30.2343

Mayo-Stille

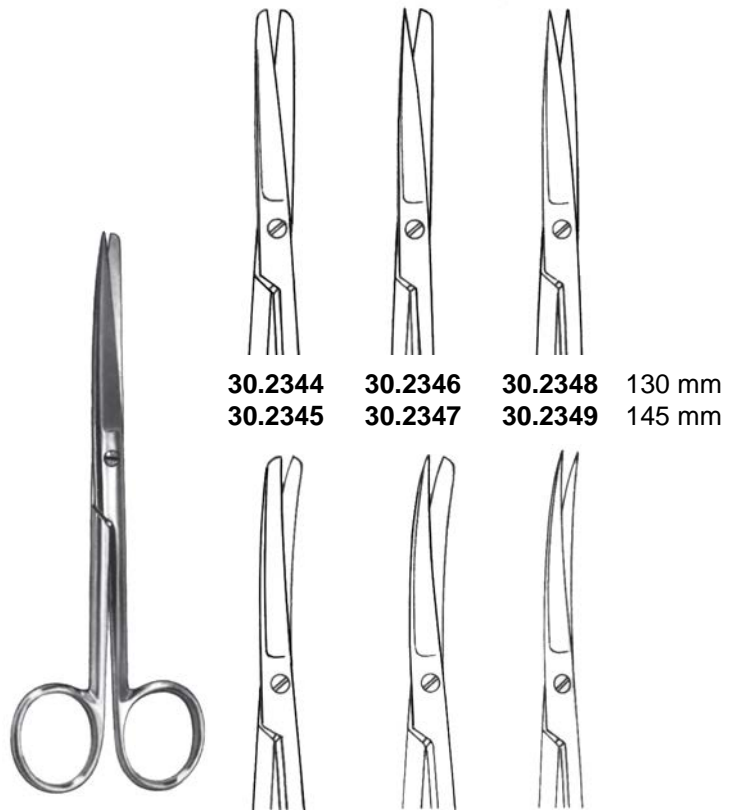

30.2344	30.2346	30.2348	130 mm
30.2345	30.2347	30.2349	145 mm

Grazil

30.2350	30.2352	30.2354	130 mm
30.2351	30.2353	30.2355	145 mm



Deaver

30.2356 145 mm **30.2357**

30.2358 145 mm **30.2359**

ostrze ząbkowane
serrated edge
зубчатое остриё

Mixer

30.2360 155 mm **30.2361**

30.2362 155 mm **30.2363**

ostrze ząbkowane
serrated edge
зубчатое остриё

brzuszne • abdominal • брюшные

do nacięć • for incisions • для нарезки



Richter

30.2364 130 mm

30.2365 145 mm

30.2366 145 mm

30.2577 170 mm

30.2578

30.2579

Doyen

30.2367 160 mm

30.2368 175 mm

30.2369

30.2370

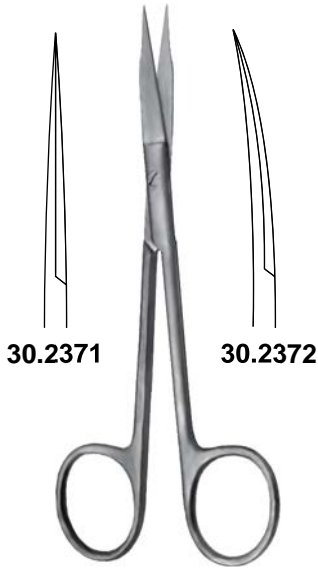

Goldmann-Fox

130 mm



Mayo-Lexer

30.2373.000 160 mm **30.2374.000**

wąskie • delicate • тонкие:

30.2373.100 **30.2374.100**



Baby-Lexer

30.2375 100 mm **30.2376**



Mayo-Noble

30.2378 170 mm **30.2380**



Mayo-Harrington

30.2382 230 mm **30.2381**
(proste) (odgięte)



Metzenbaum-Lahey
30.2395 140 mm 30.2396

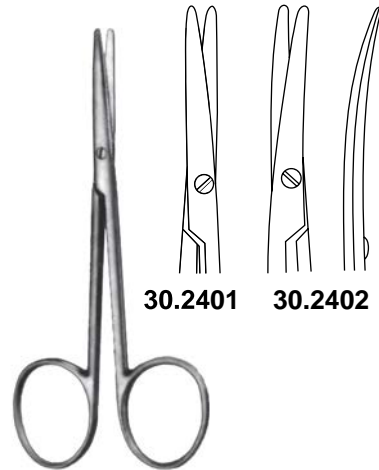

**Metzenbaum
(Strabismus)**
115 mm



Kelly
30.2403 160 mm 30.2405
30.2404 180 mm 30.2406



Joseph
30.2407 145 mm 30.2408



Kilner
30.2409 130 mm
30.2410 150 mm

operacyjne, ginekologiczne • operating, gynecological • операционные, гинекологические

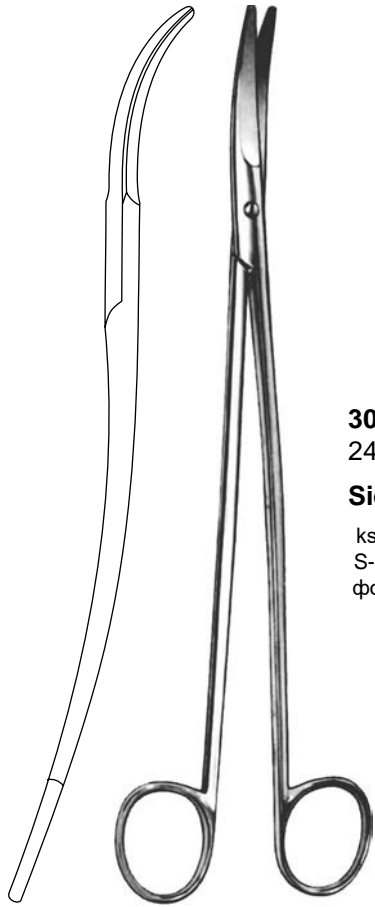

30.2397
240 mm

Siebold

kształt S
S-curved
форма S



30.2398 145 mm
30.2399 195 mm
30.2400 225 mm

Wertheim

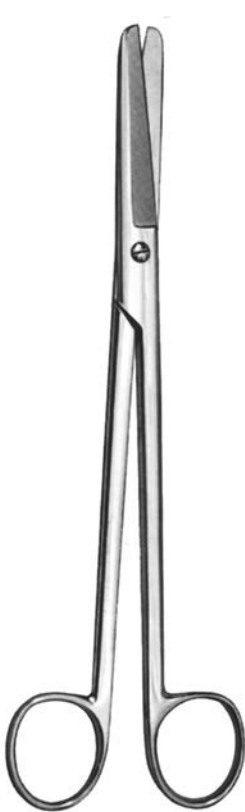

Sims



30.2411 200 mm
30.2412 230 mm



30.2413 200 mm
30.2414 230 mm

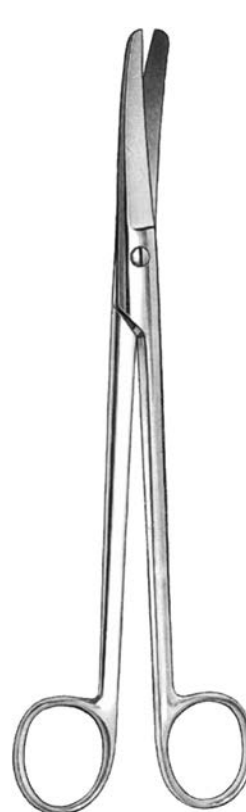

Sims



30.2415 200 mm
30.2416 230 mm



30.2417 200 mm
30.2418 230 mm

ginekologiczne, położnicze • umbilical and perineum • гинекологические, для пуповины



Dubois
30.2419 270 mm 30.2420

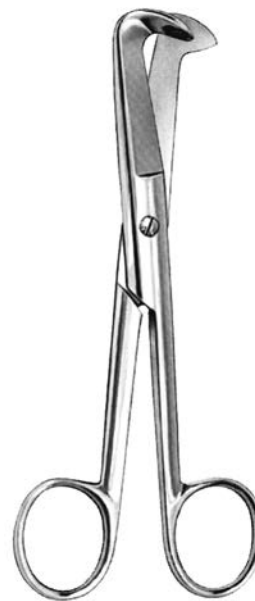

Schumacher
30.2422 155 mm



Busch
30.2423 130 mm
30.2424 160 mm



Mod. USA
30.2421 105 mm



Braun-Stadler
30.2425 145 mm
30.2426 220 mm



Waldmann
30.2531 180 mm

preparacyjne i naczyniowe • dissecting and vascular • анатомические и сосудистые

Tönnis
30.2427 180 mm **30.2428**

Adson-Tönnis
30.2429 175 mm

Reynolds
30.2430 160 mm

30.2431
 115 mm

Dandy
30.2432
 170 mm

Potts-Smith
30.2433
 190 mm

Strully
30.2434
 220 mm

Satynsky
30.2435
 245 mm

preparacyjne i naczyniowe • dissecting and vascular • анатомические и сосудистые

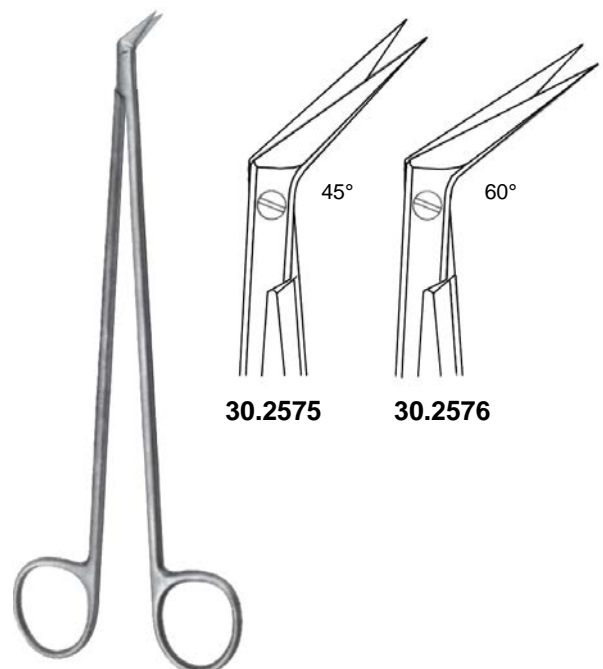
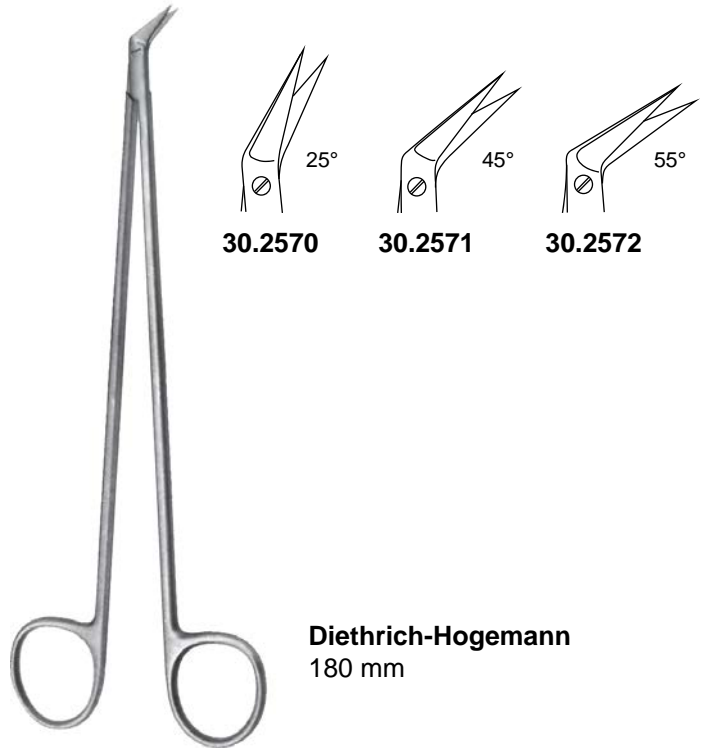
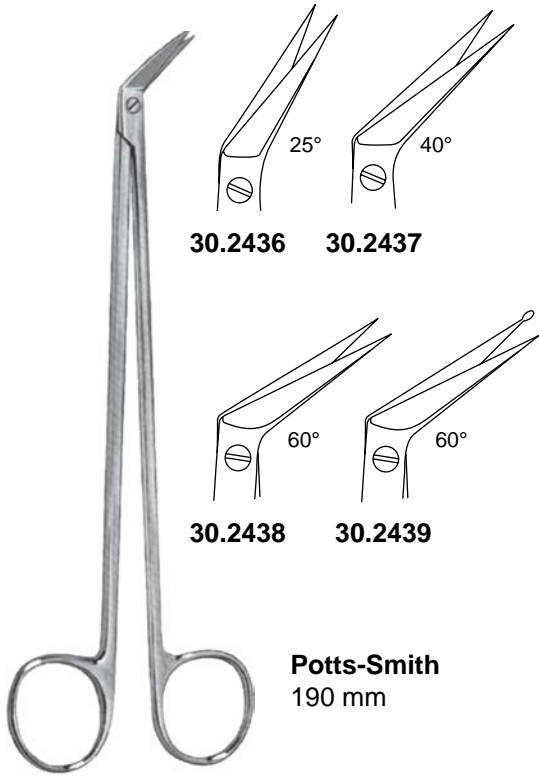

Dietrich
30.2573 170 mm 30.2574

De Bakey
155 mm



Schmieden
30.2441
170 mm
dura



30.2446
180 mm



30.2466	115 mm	30.2469
30.2467	130 mm	30.2470
30.2468	145 mm	30.2471



Dean
30.2443
170 mm



Good
30.2444
190 mm



Prince
30.2447
175 mm



Bottcher
30.2448
180 mm

do chrząstki
cartilage scissors
для хряща



Mc Indoe
30.2449
190 mm

do opatrunków, szwów, paznokci • ligature, nail scissors • для лигатуры, для ногтей



Ligaturschere

30.2450 115 mm **30.2451**

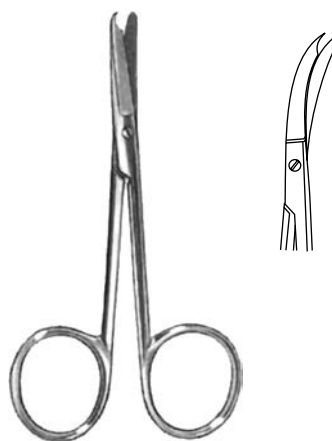

Spencer

30.2452 90 mm **30.2455**
30.2453 105 mm
30.2454 125 mm **30.2456**



Sistrunk

30.2457 130 mm **30.2458**



30.2459
 150 mm



Littauer

30.2460
 140 mm

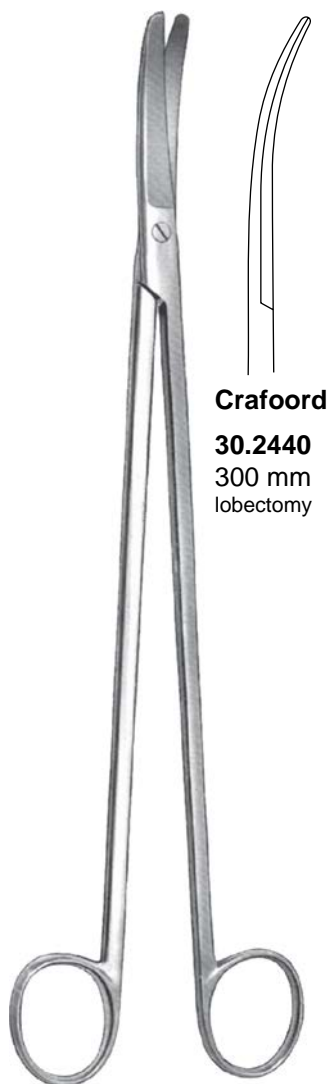

Crafoord
30.2440
300 mm
lobectomy



Darmschere
30.2461
210 mm



Darmschere
30.2462
210 mm

do opatrunków i do gipsu • bandage and plaster • перевязочные



Smith
30.2827 180 mm
30.2828 200 mm
30.2829 230 mm



Lorenz
30.2830
230 mm



Knowles
145 mm
30.2831
proste
straight
прямые



30.2832
odgięte
curved
изогнутые

do opatrunków i do gipsu • bandage and plaster • перевязочные



Esmarch
 40.3284 200 mm
 40.3285 230 mm



Seutin
 40.3286
 230 mm



Bruns
 40.3287
 235 mm



do gipsu syntetycznego
 for syntetic plaster
 для синтетического гипса

40.4139
 180 mm



40.4140
 180 mm



Lister
 40.4141 90 mm
 40.4142 110 mm
 40.4143 140 mm
 40.4144 180 mm
 40.4145 200 mm

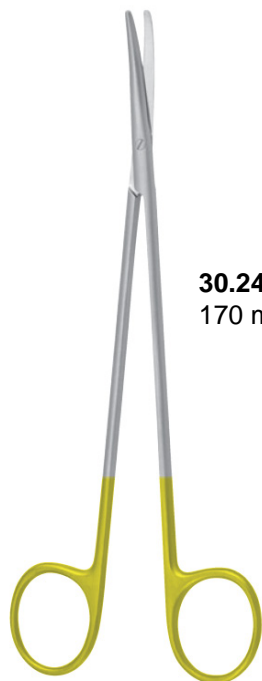

30.2472
170 mm

Tönnis-Adson



Standard

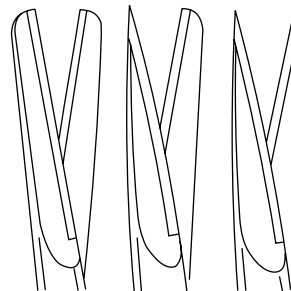

proste • straight • прямые

30.2473.000	30.2474.000	30.2475.000
	145 mm	
30.2473.165	30.2474.165	30.2475.165
	165 mm	

odgięte • curved • загнутые

30.2476.000	30.2477.000	30.2478.000
	145 mm	
30.2476.165	30.2477.165	30.2478.165
	165 mm	



Metzenbaum

30.2479	145 mm	30.2483
30.2480	180 mm	30.2484
30.2481	200 mm	30.2485
30.2482	230 mm	30.2486



Metzenbaum-Fino

30.2487	145 mm	30.2491
30.2488	180 mm	30.2492
30.2489	200 mm	30.2493
30.2490	230 mm	30.2494



Mayo-Stille

30.2499	150 mm	30.2501
30.2500	170 mm	30.2502



Mayo

30.2495	145 mm	30.2497
30.2496	170 mm	30.2498



30.2504

Mayo-Lexer
30.2503 165 mm

Lister
30.2505.140 140 mm
30.2505.000 180 mm
30.2505.200 200 mm

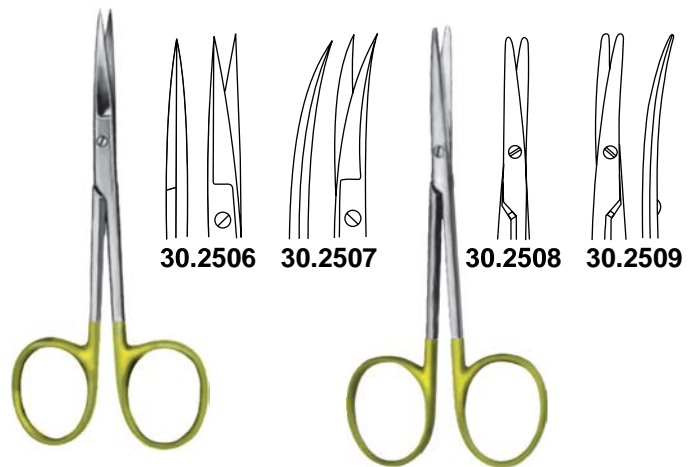

30.2506

30.2507

30.2508

30.2509

Irisschere
115 mm

Strabismus (Metzenbaum)
115 mm

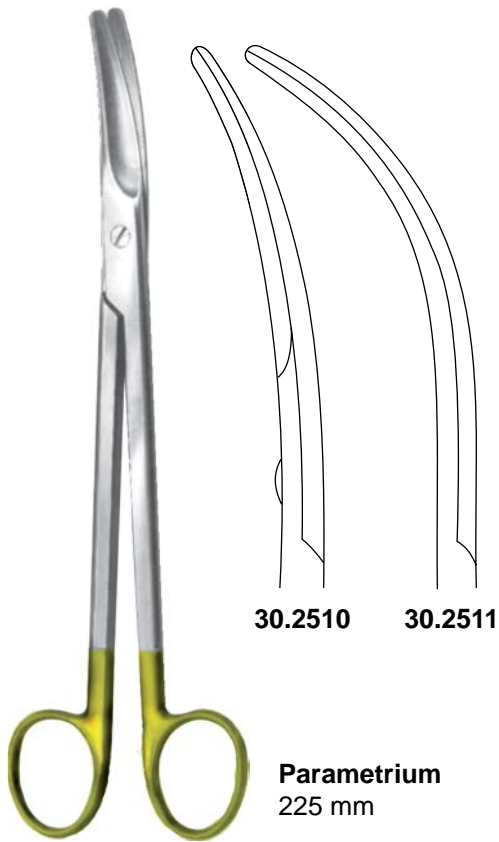

30.2510 **30.2511**

Parametrium
225 mm

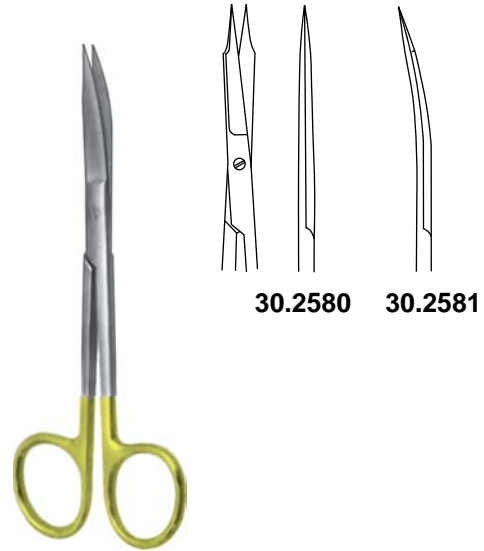

30.2580 **30.2581**

Goldmann-Fox
130 mm

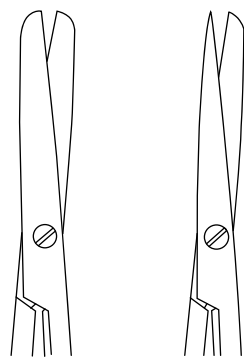

30.2582 **30.2584**
200 mm 200 mm

30.2583 **30.2585**
230 mm 230 mm
proste • straight • прямые

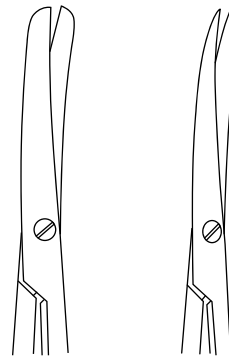

30.2586 **30.2588**
200 mm 200 mm

30.2587 **30.2589**
230 mm 230 mm
odgięte • curved • изогнутые

Sims



jedno ostrze tnące, drugie mikro-ząbkowane • with knife edge and micro-serrated edge • с одним лезвием режущим, другим микрозубчатым



Mayo

30.2532	145 mm	30.2534
30.2533	170 mm	30.2535
30.2533.230	230 mm	30.2535.230

Mayo-Stille

30.2536	150 mm	30.2538
30.2537	170 mm	30.2539

Mayo-Lexer

30.2540	160 mm	30.2541
----------------	--------	----------------



Metzenbaum

30.2542	145 mm	30.2543
----------------	--------	----------------

Metzenbaum

30.2544	180 mm	30.2545	180 mm
30.2557	200 mm	30.2562	200 mm
30.2558	230 mm	30.2563	230 mm
30.2559	250 mm	30.2564	250 mm
30.2560	280 mm	30.2565	280 mm
30.2561	300 mm	30.2566	300 mm

jedno ostrze tnące, drugie mikro-ząbkowane • with knife edge and micro-serrated edge • с одним лезвием режущим, другим микрозубчатым



Metzenbaum Fino

30.2546 145 mm **30.2547**

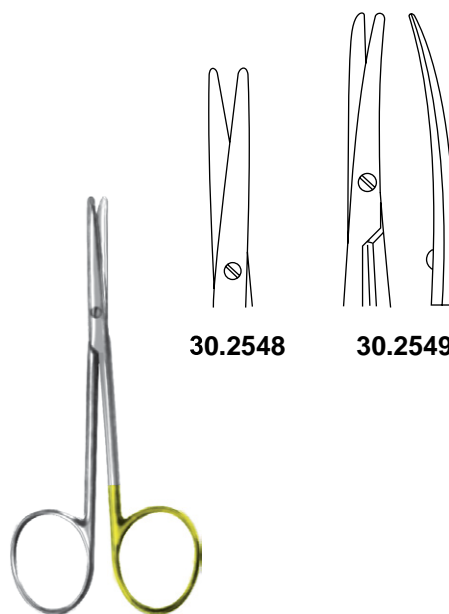

30.2548

30.2549

Metzenbaum Strabismus

115 mm



Lister

30.2550 140 mm
30.2551 180 mm
30.2552 200 mm



30.2553

30.2554

Iris

115 mm



30.2555

30.2556

Stevens

110 mm



La Grange

30.2567 105 mm
30.2568 160 mm

anatomiczne • anatomical • анатомические



Standard

30.3300 105 mm **30.3309**
30.3301 115 mm **30.3310**
30.3302 130 mm **30.3311**
30.3303 145 mm **30.3312**
30.3304 160 mm **30.3313**
30.3305 180 mm **30.3314**
30.3306 200 mm **30.3315**
30.3307 250 mm **30.3316**
30.3308 300 mm **30.3317**

Standard

30.3318 115 mm **30.3326**
30.3319 130 mm **30.3327**
30.3320 145 mm **30.3328**
30.3321 160 mm **30.3329**
30.3322 180 mm **30.3330**
30.3323 200 mm **30.3331**
30.3324 250 mm **30.3332**
30.3325 300 mm **30.3333**
 wąskie • r зкие

Standard mod. USA

30.3334 120 mm **30.3342**
30.3335 130 mm **30.3343**
30.3336 145 mm **30.3344**
30.3337 155 mm **30.3345**
30.3338 180 mm
30.3339 210 mm ▲ wąskie
30.3340 250 mm narrow
30.3341 310 mm узкие

delikatne
slender
деликатные
▼

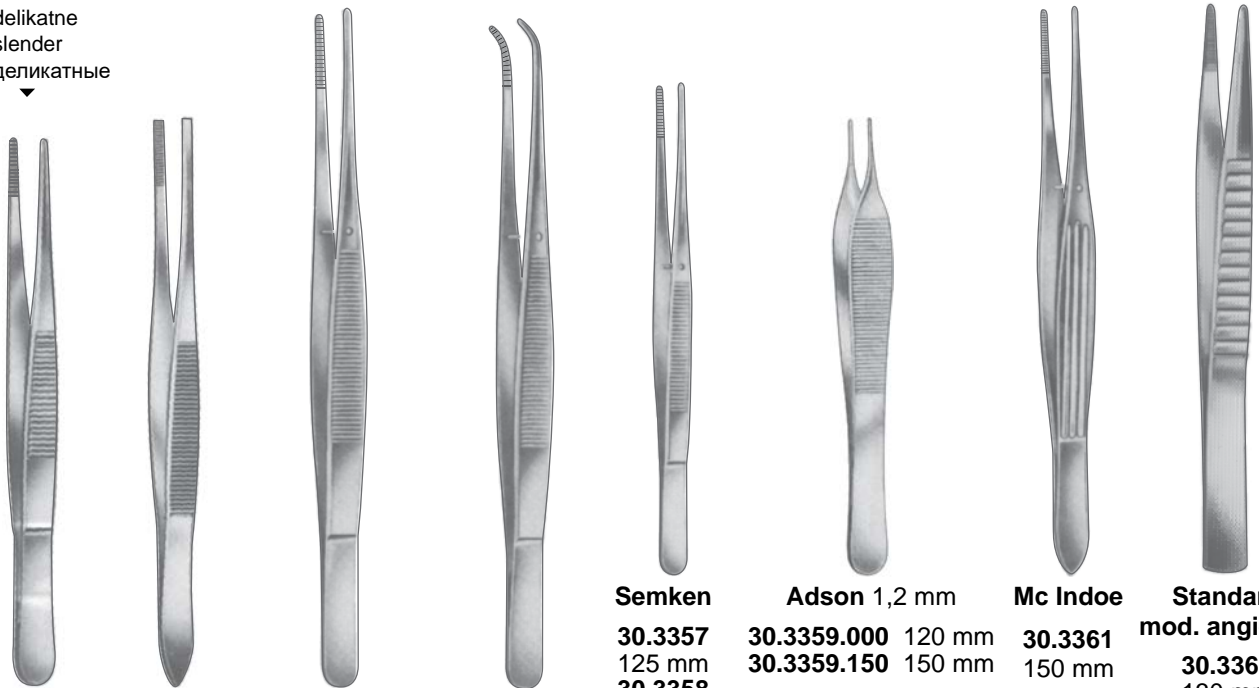

Standard

30.3346 130 mm **30.3348**
30.3347 150 mm **30.3349**
 170 mm **30.3350**

Potts-Smith

30.3351 180 mm **30.3354**
30.3352 210 mm **30.3355**
30.3353 250 mm **30.3356**

Semken

30.3357 125 mm
30.3358 150 mm

Adson 1,2 mm

30.3359.000 120 mm
30.3359.150 150 mm
Adson 0,8 mm mikro
30.3360.000 120 mm
30.3360.150 150 mm

Mc Indoe

30.3361 150 mm

Standard mod. angielski

30.3362 130 mm
30.3363 145 mm
30.3364 155 mm

anatomiczne • anatomical • анатомические



Taylor

30.3365 175 mm **30.3366**



Taylor

30.3367 175 mm **30.3368**



Gerald

30.3369 180 mm
prosta • straight • прямая

30.3370 180 mm
odgięta • curved • изогнутая



Waugh

30.3371 150 mm
30.3372 200 mm



Cushing

30.3373 175 mm **30.3374**



30.3375



30.3376



30.3377

delikatne • slender • деликатные
105 mm



Brophy

30.3378 200 mm **30.3379**



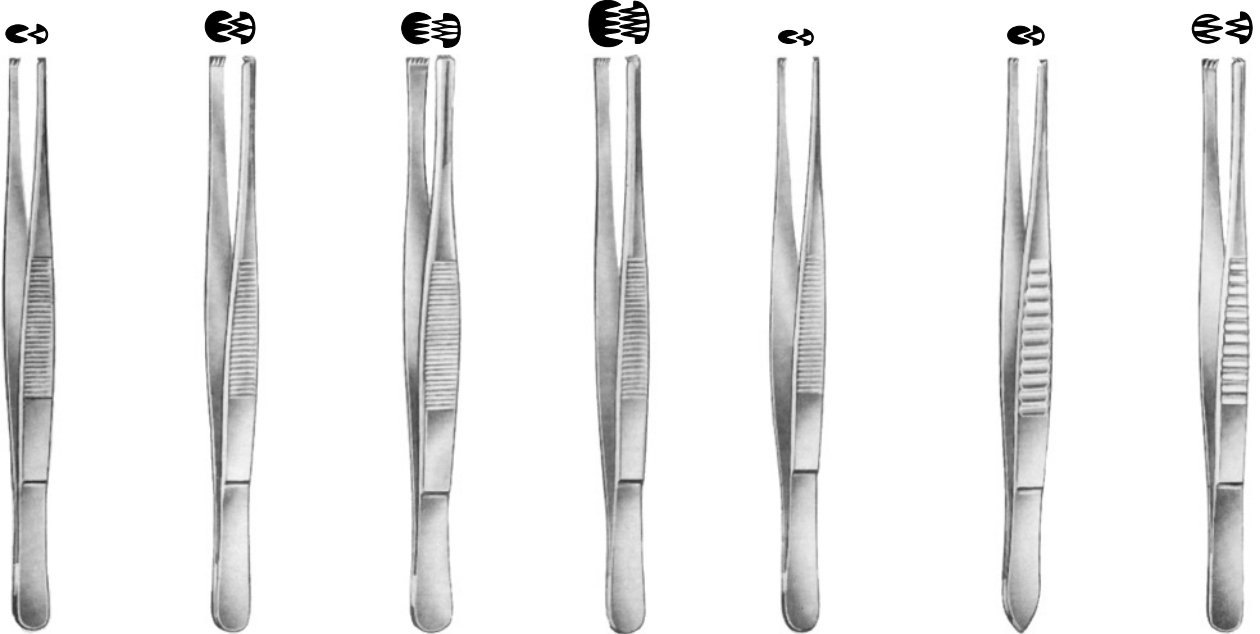

Standard

1:2		2:3
30.3380	105 mm	
30.3381	115 mm	30.3389
30.3382	130 mm	30.3390
30.3383	145 mm	30.3391
30.3384	160 mm	30.3392
30.3385	180 mm	30.3393
30.3386	200 mm	30.3394
30.3387	250 mm	30.3395
30.3388	300 mm	30.3396

Standard

3:4		4:5
30.3397	130 mm	30.3400
30.3398	145 mm	30.3401
30.3399	160 mm	30.3402

Standard

1:2	
30.3403	130 mm
30.3404	145 mm
30.3405	160 mm
30.3406	200 mm

▲
wąska
narrow
узкие

Standard mod. USA

1:2		2:3
30.3407	120 mm	30.3415
30.3408	130 mm	30.3416
30.3409	145 mm	30.3417
30.3410	155 mm	30.3418
30.3411	180 mm	30.3419
30.3412	210 mm	30.3420
30.3413	250 mm	30.3421
30.3414	310 mm	30.3422



Standard mod. USA

1:2	
30.3429	130 mm
30.3430	145 mm
30.3431	150 mm

▲
delikatna
slender
узкая



Gerald

30.3432 175 mm **30.3433**



Gillies

30.3434
150 mm

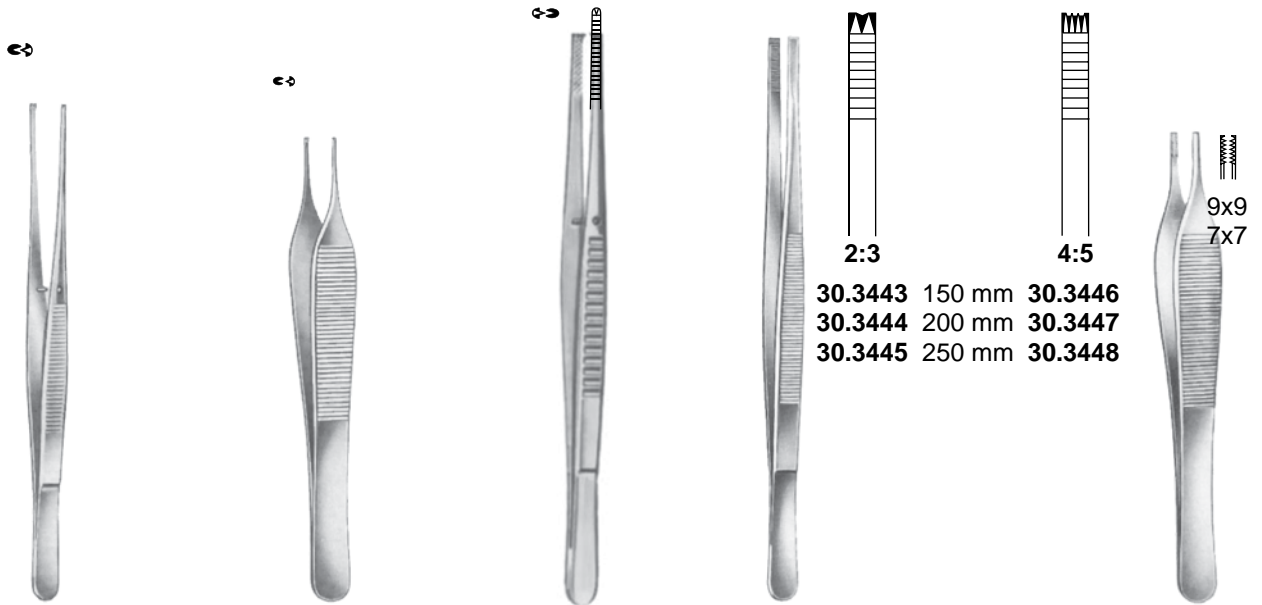

2:3
30.3443 150 mm
30.3444 200 mm
30.3445 250 mm

4:5
30.3446
30.3447
30.3448

Semken		Adson		Waugh		Adlerkreutz		Adson-Brown	
		1,2 mm							
30.3435	125 mm	30.3437	120 mm	30.3439	0,8 mm	30.3441	150 mm	30.3449.000	120 mm, 9X9
30.3436	150 mm	30.3438	150 mm	30.3440		30.3442	200 mm	30.3449.007	120 mm, 7x7



Tayler		Brophy		Cushing		Tayler	
30.3450	175 mm	30.3451	150 mm	30.3452	200 mm	30.3453	175 mm
30.3454	175 mm	30.3455	150 mm	30.3456	175 mm	30.3457	150 mm



Potts-Smith

30.3458 180 mm 30.3461
30.3459 210 mm 30.3462
30.3460 250 mm 30.3463

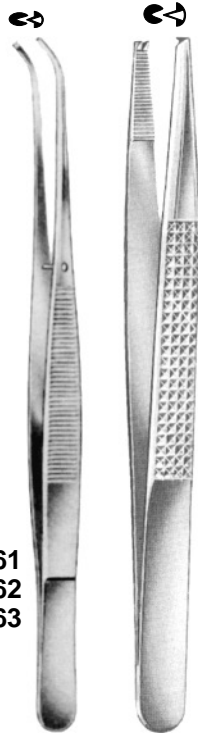

Bonney
180 mm

1:2 2:3
30.3464 30.3465



1:2

30.3466 145 mm



Lane

2:3

30.3467 180 mm 30.3468
30.3469



plucne chwytajace • lung grasping • для легких



Russian

30.3470 150 mm
30.3471 200 mm
30.3472 250 mm



Mayo-Russian

30.3473
230 mm



Nelson

30.3474.180 180 mm
30.3474.000 230 mm



Singley-Tut

30.3475
230 mm

delikatne • slender • деликатные



30.3480
105 mm



30.3481
105 mm



30.3482
105 mm

atraumatyczne • atraumatic • хирургические



De Bakey

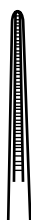

1,5 mm

- 30.3483**
- 30.3484**
- 30.3485**
- 30.3486**

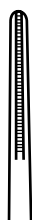

2,0 mm

- 30.3487**
- 30.3488**
- 30.3489**
- 30.3490**

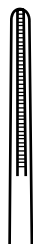

2,7 mm

- 30.3491**
- 30.3492**
- 30.3493**
- 30.3494**

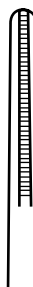

3,5 mm

- 30.3495**
- 30.3496**
- 30.3497**
- 30.3498**

- 160 mm
- 200 mm
- 240 mm
- 300 mm



De Bakey

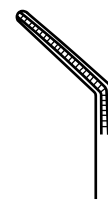

2,0 mm

- 30.3499**
- 30.3500**
- 30.3501**
- 30.3502**

pincety ENT • ENT forceps • ENT пинцеты

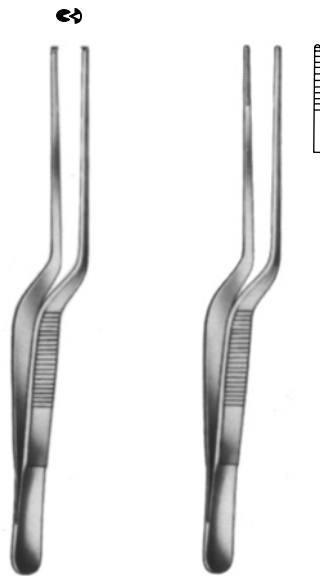

Lucae 1 x 2
30.3504
140 mm

Lucae
30.3505
140 mm

laboratoryjne • cover glass forceps • лабораторные



Kuehne
30.3594
105 mm



Kuehne
30.3595
105 mm

inne • others • другие



Littauer
30.3591
85 mm



Douglas
30.3592
90 mm



Douglas
30.3593
90 mm

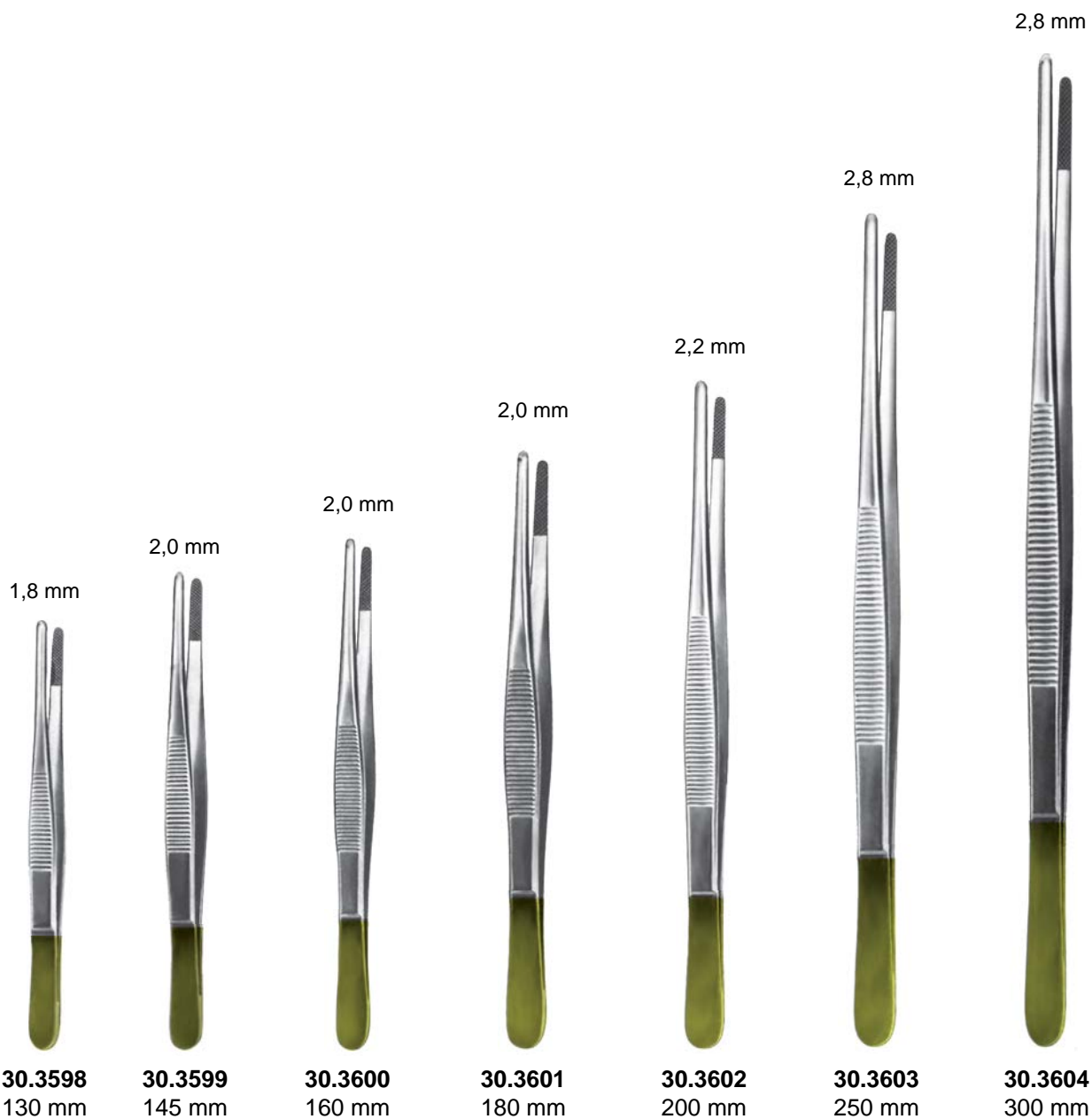



Adson

1,6 mm
30.3605 120 mm **30.3607**
30.3606 150 mm **30.3608**



Cushing
170 mm

1,8 mm
30.3609
30.3610



Chir. Pinzette

30.3611 140 mm **30.3612** 160 mm
30.3613 180 mm **30.3614** 200 mm



30.3615
250 mm



Potts-Smith

30.3616 180 mm
30.3617 210 mm
30.3618 250 mm

180 mm = 1,8 mm
 210 mm = 2,0 mm
 250 mm = 2,5 mm



Wangenstein

4,5 mm
30.3619 150 mm
 5,5 mm
30.3620 230 mm



Ferris-Smith

30.3621 170 mm





Halsted-Mosquito

30.0080 125 mm **30.0083**
30.0081 140 mm **30.0084**
30.0082 125 mm **30.0085**
 mikro • micro • микро

Halsted-Mosquito

30.0086 125 mm **30.0089**
30.0087 140 mm **30.0090**
30.0088 125 mm **30.0091**
 mikro • micro • микро

Halsted-Mosquito

30.0083.100
 125mm



Hartmann

30.0092 100 mm **30.0094**
 mikro • micro • микро
30.0093 100 mm **30.0095**



Hartmann

30.0092.100 100mm **30.0094.100**
 mikro • micro • микро

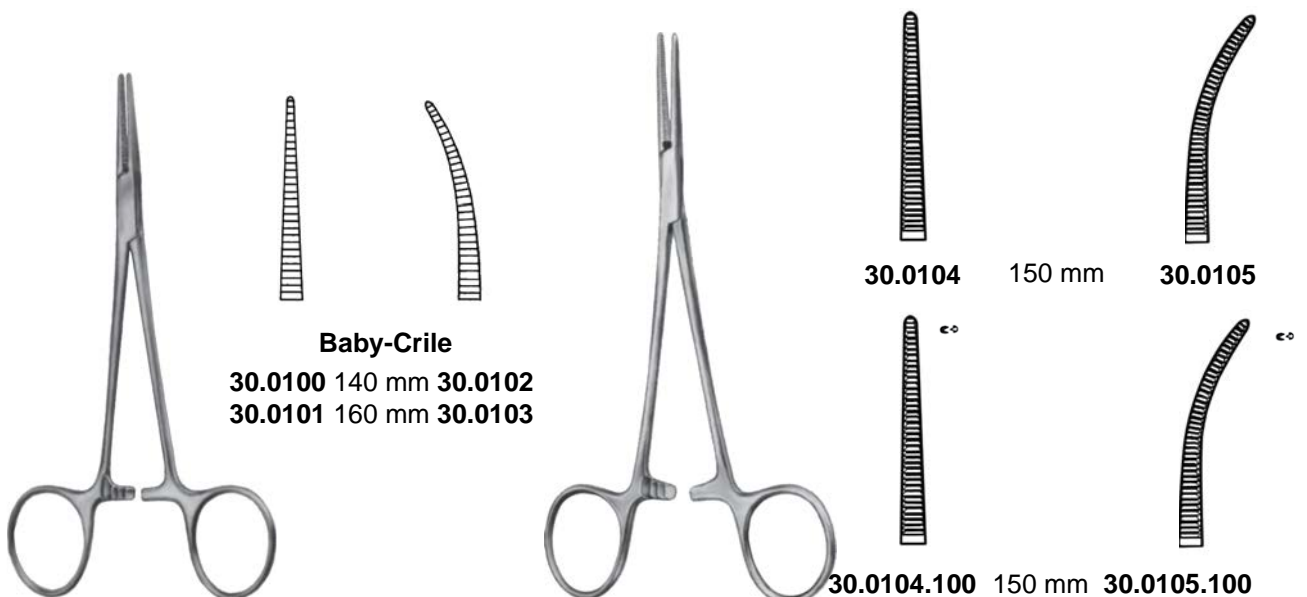

Baby-Crile

30.0100 140 mm **30.0102**
30.0101 160 mm **30.0103**

Leriche

30.0104.100 150 mm **30.0105.100**

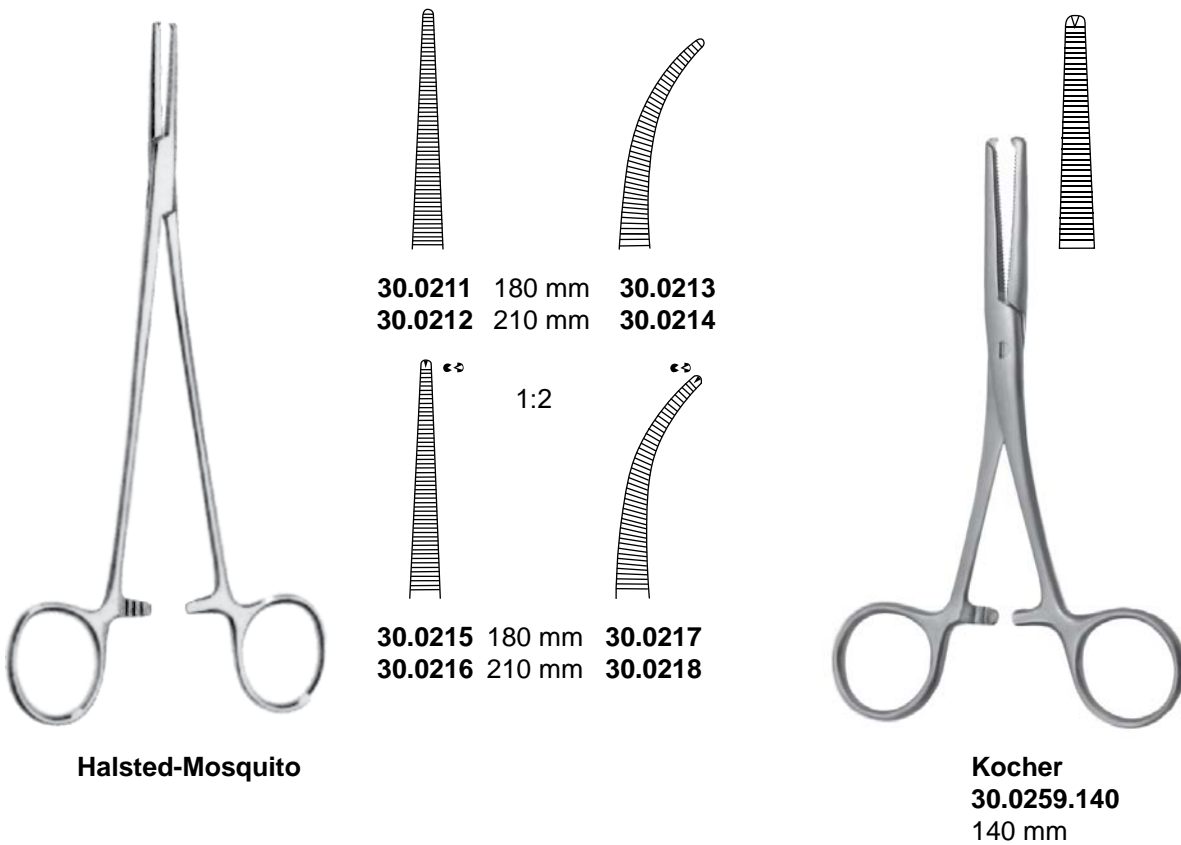
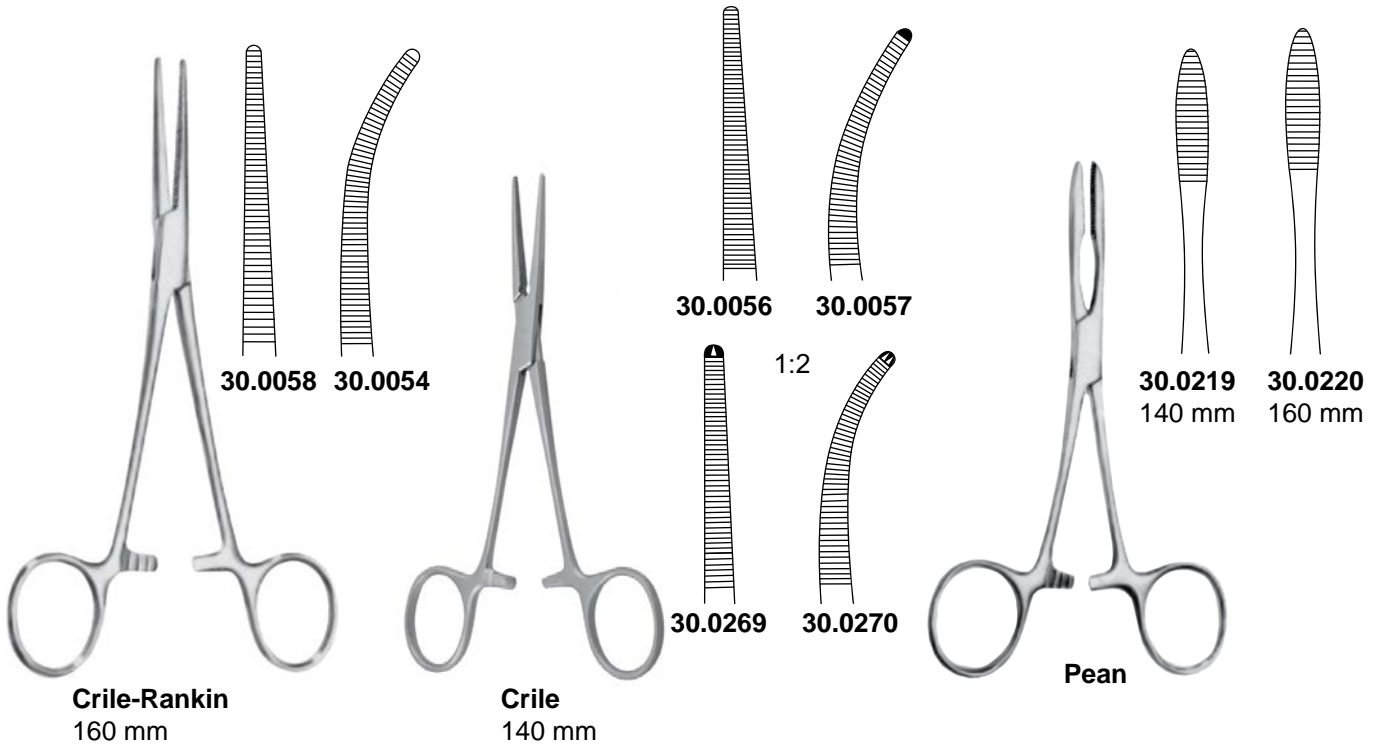



30.0221.130 130 mm
30.0221.000 140 mm
 proste
 straight
 прямой

30.0222.130 130 mm
30.0222.000 140 mm
 odgięte
 curved
 изогнутый

Pean
 delikatne • fine • тонкие

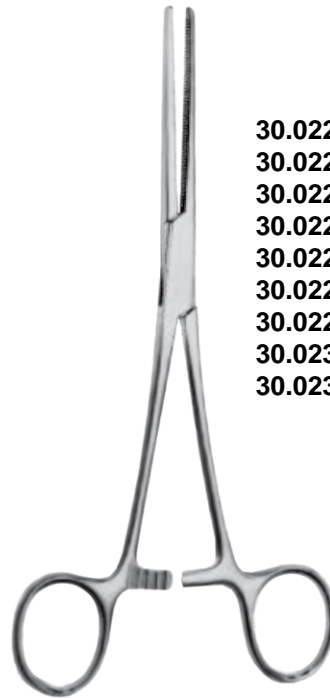

30.0223	130 mm	30.0232
30.0224	140 mm	30.0233
30.0225	160 mm	30.0234
30.0226	180 mm	30.0235
30.0227	200 mm	30.0236
30.0228	220 mm	30.0237
30.0229	240 mm	30.0238
30.0230	260 mm	30.0239
30.0231	300 mm	30.0240

Pean (Rochester)

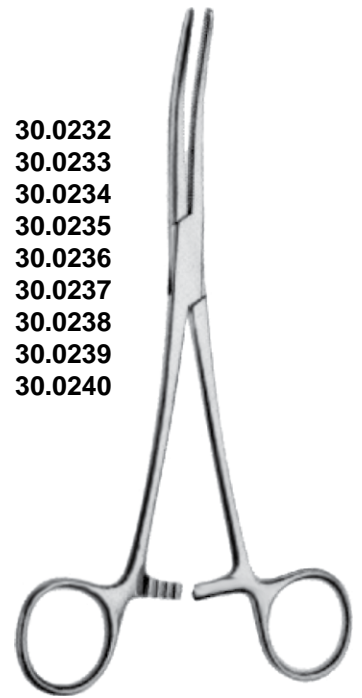

Pean (Rochester)



30.0241	130 mm	30.0250
30.0242	140 mm	30.0251
30.0243	160 mm	30.0252
30.0244	180 mm	30.0253
30.0245	200 mm	30.0254
30.0246	220 mm	30.0255
30.0247	240 mm	30.0256
30.0248	260 mm	30.0257
30.0249	300 mm	30.0258

Kocher (Ochsner)

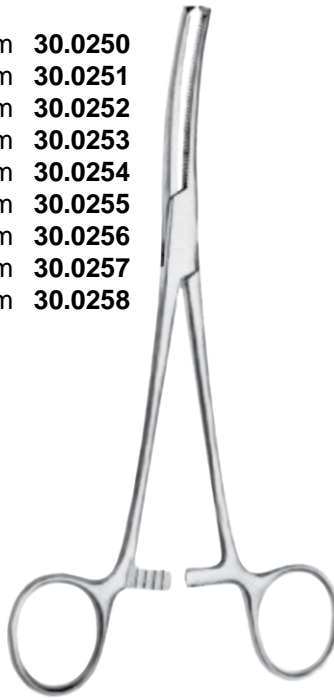

Kocher (Ochsner)

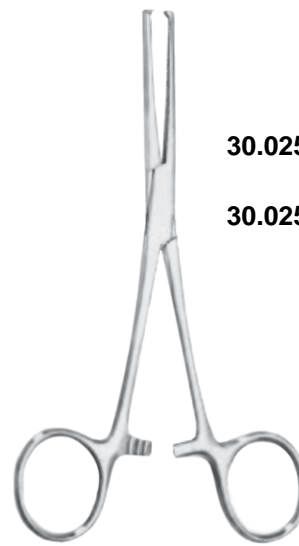

Kocher 140 mm
 delikatne • slender • тонкие

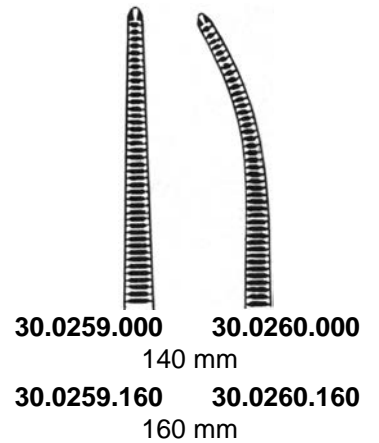

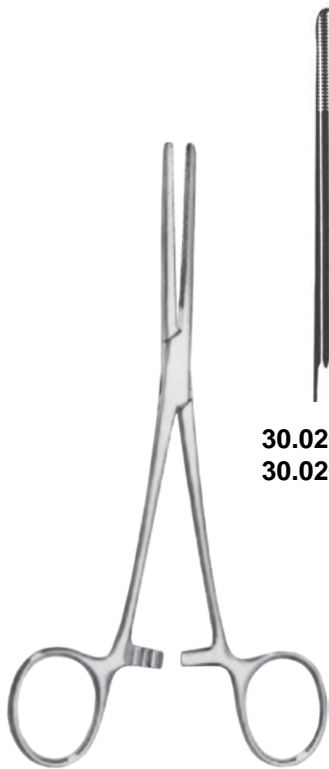

Rochester-Carmalt

30.0261 160 mm **30.0263**
30.0262 200 mm **30.0264**



Kelly
140 mm

30.0265

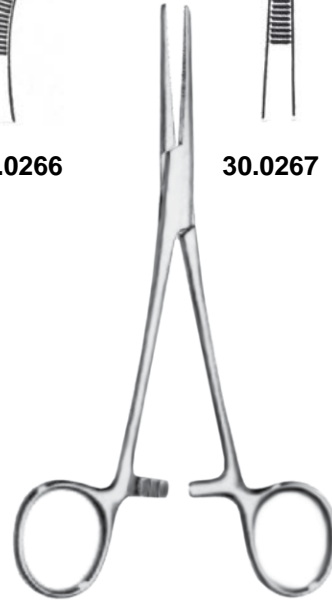

Kelly-Rankin
160 mm

30.0266



30.0267



30.0268

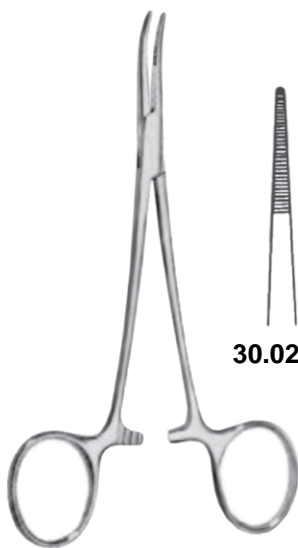

Providence Hospital
140 mm

30.0271



30.0272



Lovelace
30.0273
155 mm

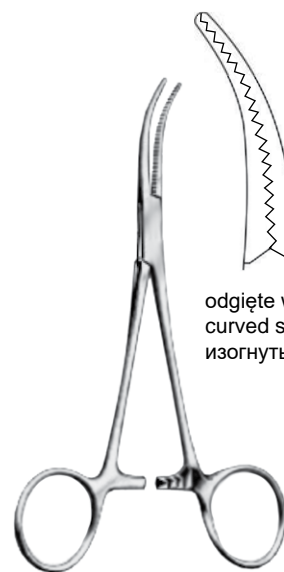

Dandy
30.0274
140 mm

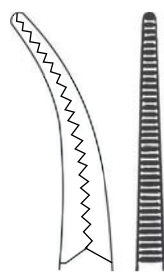

odgięte w bok
curved sideways
изогнутые на сторону



Adson
185 mm

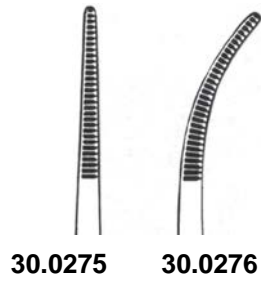

30.0275 **30.0276**

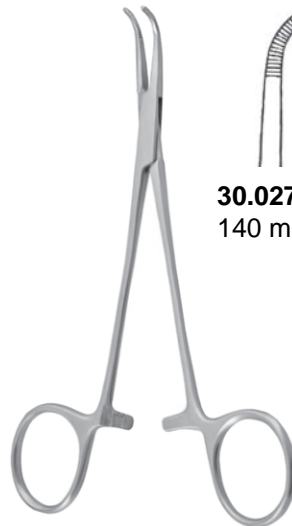

Baby-Adson

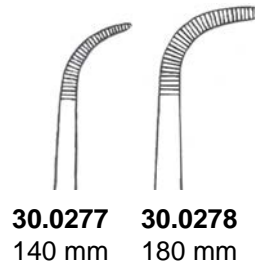

30.0277 **30.0278**
140 mm 180 mm



Pennington
30.0279 155 mm
30.2130 200 mm



Spencer-Wells

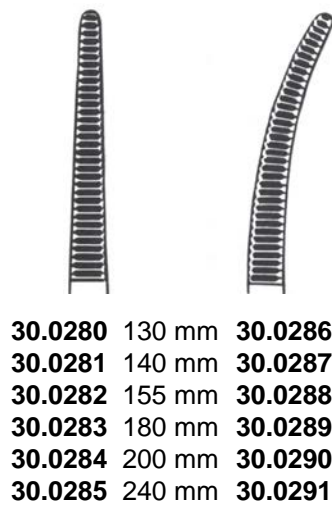

30.0280	130 mm	30.0286
30.0281	140 mm	30.0287
30.0282	155 mm	30.0288
30.0283	180 mm	30.0289
30.0284	200 mm	30.0290
30.0285	240 mm	30.0291



Heiss 200 mm

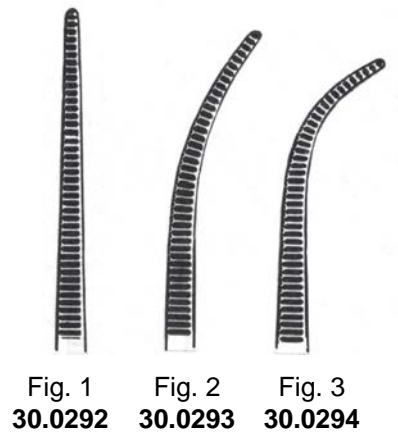

Fig. 1 **Fig. 2** **Fig. 3**
30.0292 **30.0293** **30.0294**



Roberts
220 mm



30.1900



30.1901



Zenker
295 mm

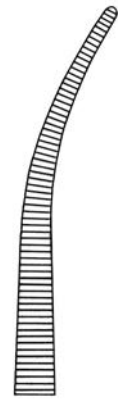

30.1902

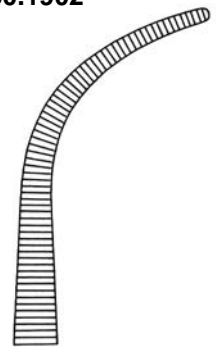

30.1903

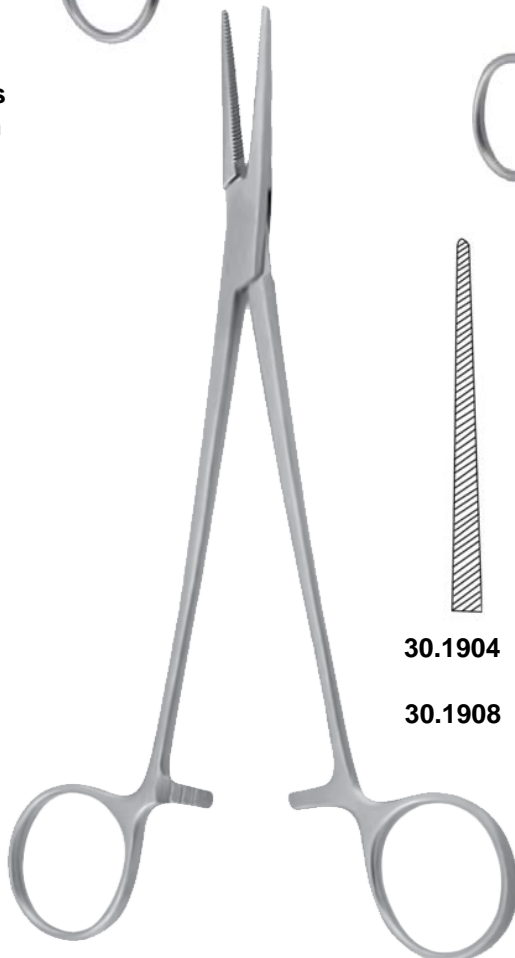

Bengolea



30.1904



30.1905



30.1906



30.1907

1:2

200 mm

30.1908

30.1909

30.1910

30.1911

260 mm



Mini-Gemini

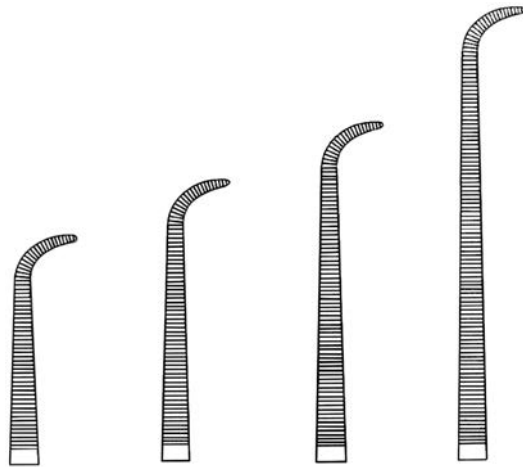

- | | | | |
|--------------------------|--------------------------|--------------------------|--------------------------|
| 30.1912
180 mm | 30.1913
220 mm | 30.1914
250 mm | 30.1915
280 mm |
|--------------------------|--------------------------|--------------------------|--------------------------|



Gemini

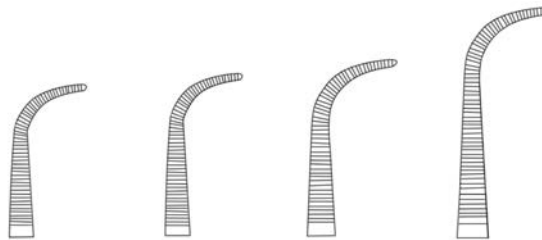

- | | | | |
|--------------------------|--------------------------|--------------------------|--------------------------|
| 30.1916
130 mm | 30.1917
140 mm | 30.1918
160 mm | 30.1919
180 mm |
|--------------------------|--------------------------|--------------------------|--------------------------|

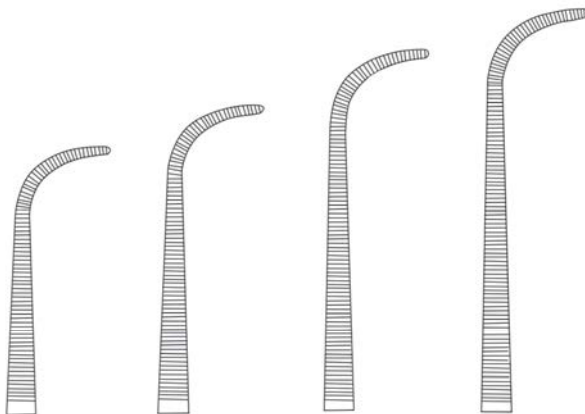

- | | | | |
|--------------------------|--------------------------|--------------------------|--------------------------|
| 30.1920
200 mm | 30.1921
230 mm | 30.1922
250 mm | 30.1923
280 mm |
|--------------------------|--------------------------|--------------------------|--------------------------|



Kantrowitz

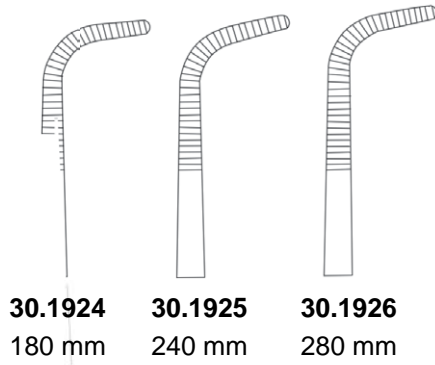

30.1924
180 mm

30.1925
240 mm

30.1926
280 mm

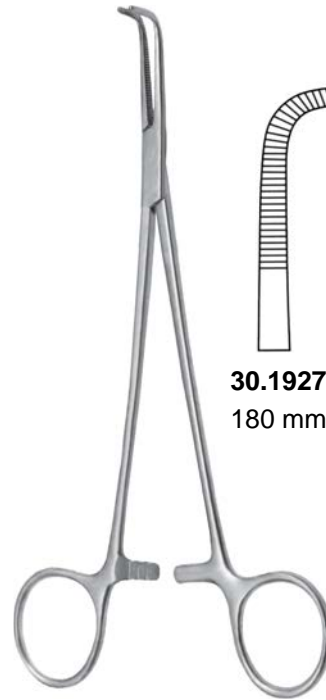

Meekers

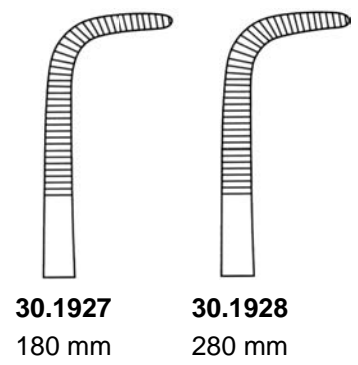

30.1927
180 mm

30.1928
280 mm



Overholt

delikatne • slender • тонкие

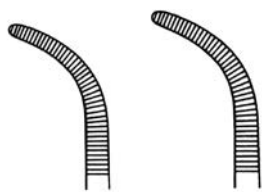

30.1929
185 mm

30.1930
210 mm

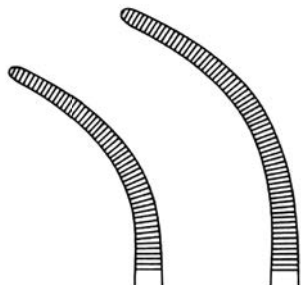

30.1931
215 mm

30.1932
220 mm

kształt S
S-shaped
форма S



Stille

30.1933 240 mm



Green

30.1934 160 mm



**Overholt-
Geissendoerfer**

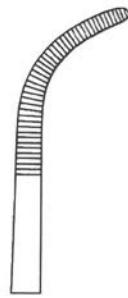

Fig. 1
30.0295
195 mm

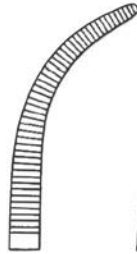

Fig. 2
30.0296
210 mm

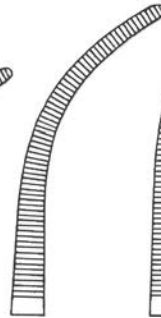

Fig. 3
30.0297
220 mm

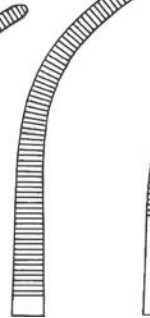

Fig. 4
30.0298
225 mm

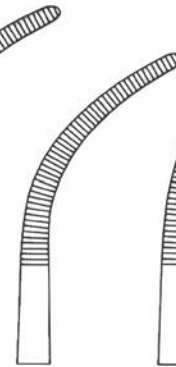

Fig. 5
30.0299
215 mm

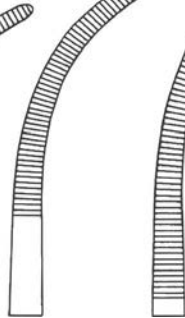

Fig. 6
30.2000
225 mm

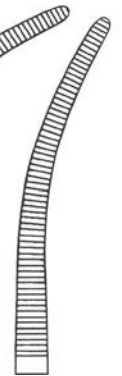

Fig. 7
30.2001
225 mm

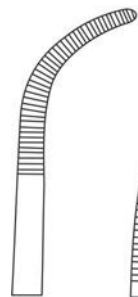

Fig. 1
30.2002
260 mm

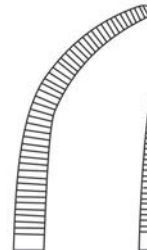

Fig. 2
30.2003
270 mm

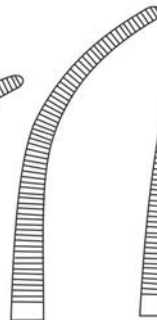

Fig. 3
30.2004
275 mm

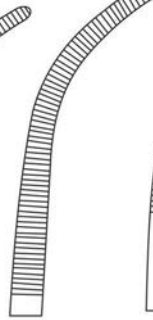

Fig. 4
30.2005
275 mm

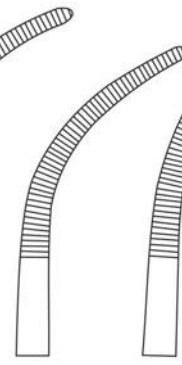

Fig. 5
30.2006
275 mm

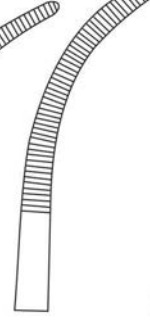

Fig. 6
30.2007
280 mm

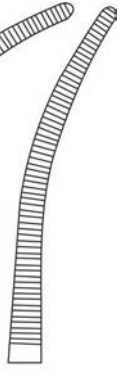

Fig. 7
30.2008
275 mm



30.2009

30.2010

30.2011

30.2012

Rumel
230 mm



30.2013
Crafoord
240 mm





Mixer-Baby
30.2014 140 mm



30.2015 155 mm
30.2016 190 mm

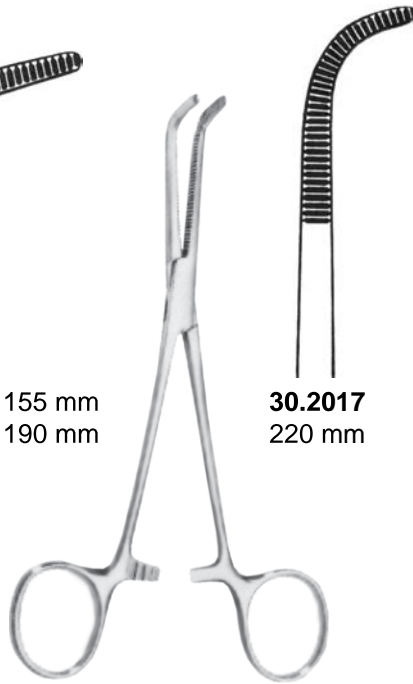

30.2017
220 mm

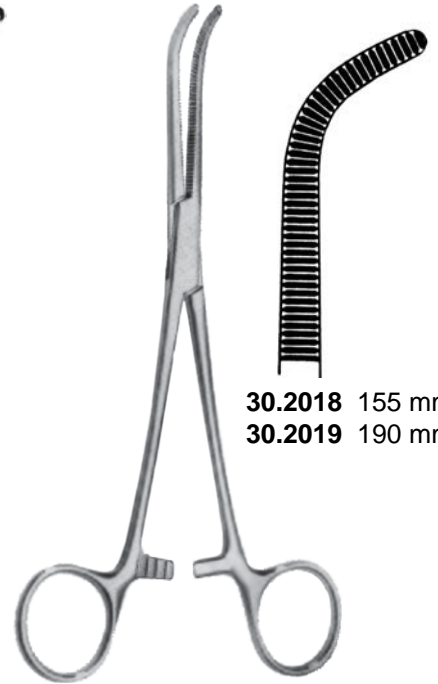

30.2018 155 mm
30.2019 190 mm

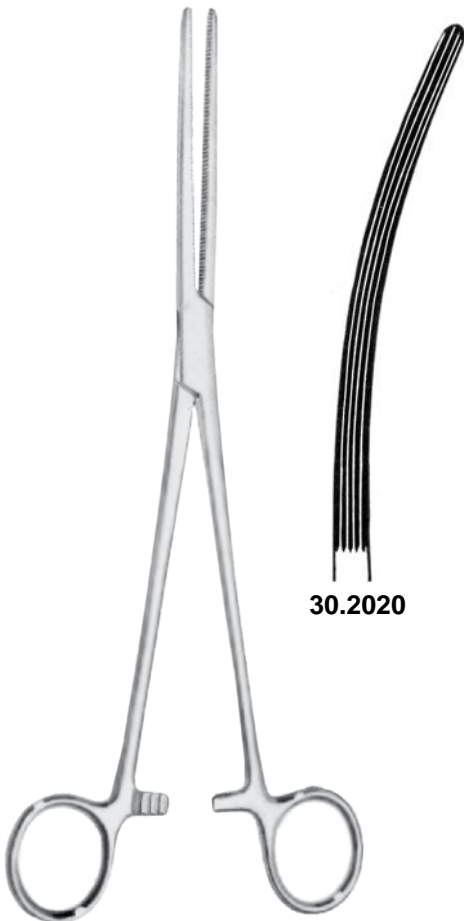

Crafoord-Sellers 240 mm

30.2020

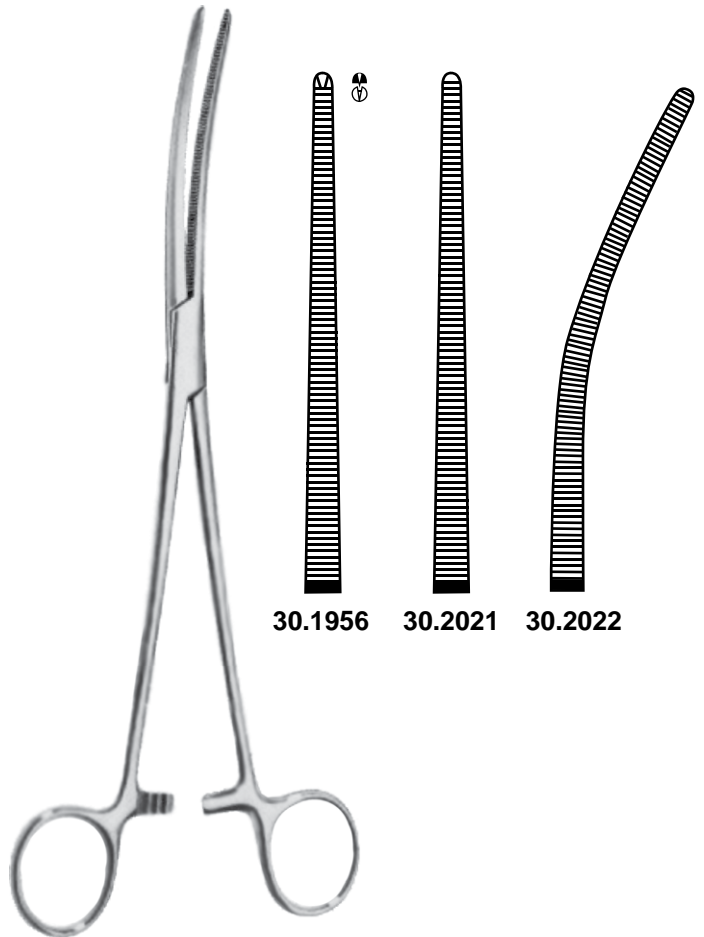

Sarot 240 mm

30.1956

30.2021

30.2022



30.2024

30.2023

Negus
190 mm



Johns Hopkins
30.2025
200 mm



Lower
30.2026
180 mm

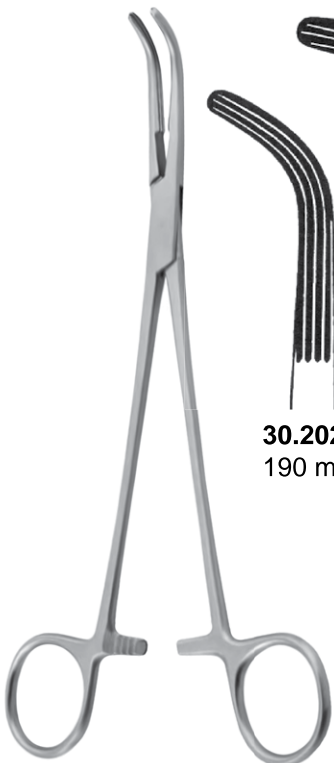

30.2027
190 mm

30.2028
230 mm

Lahey



30.2029
220 mm

30.2030
250 mm

30.2031
280 mm

Mixer

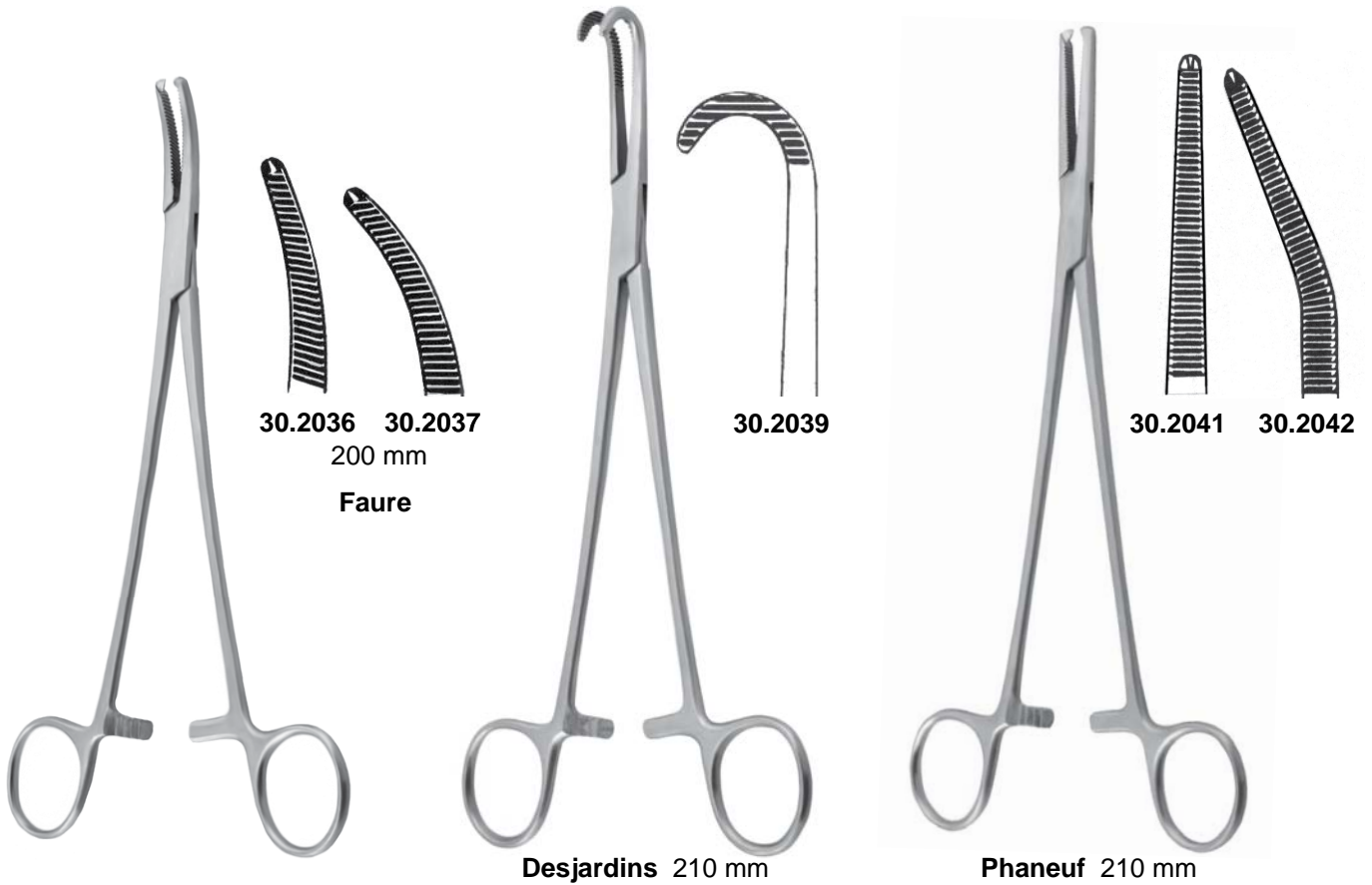



Mayo-Guyon
30.2043
230 mm



Heaney-Ballentine
30.2044 30.2045
210 mm

Heaney
30.2046 190 mm **30.2049**
30.2047 210 mm **30.2050**
30.2048 230 mm **30.2051**



Mikulicz
30.2052.001
180 mm



30.2052.140 140 mm
30.2052.000 180 mm
30.2053.000 200 mm **30.2054**

Mikulicz

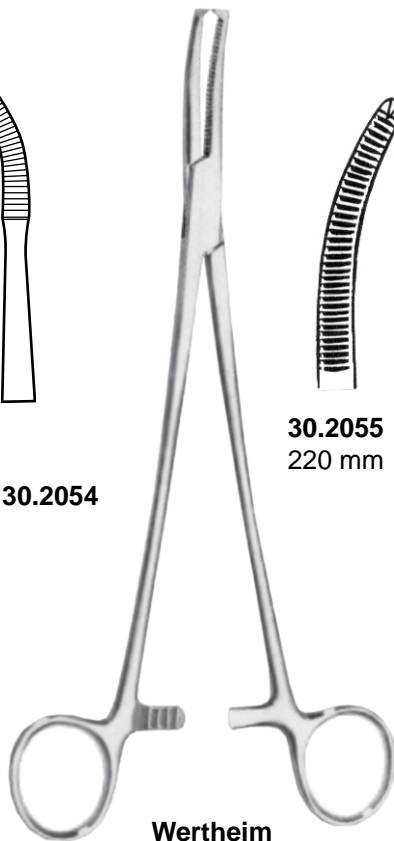

30.2055
220 mm

Wertheim

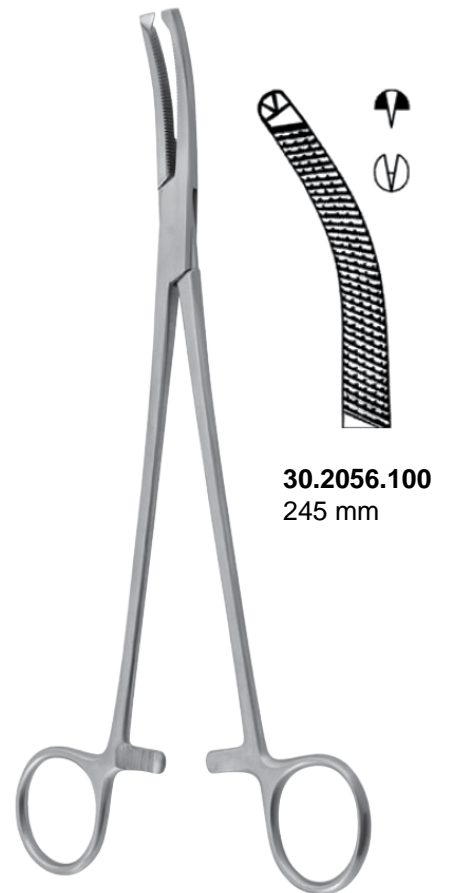

30.2056.100
245 mm

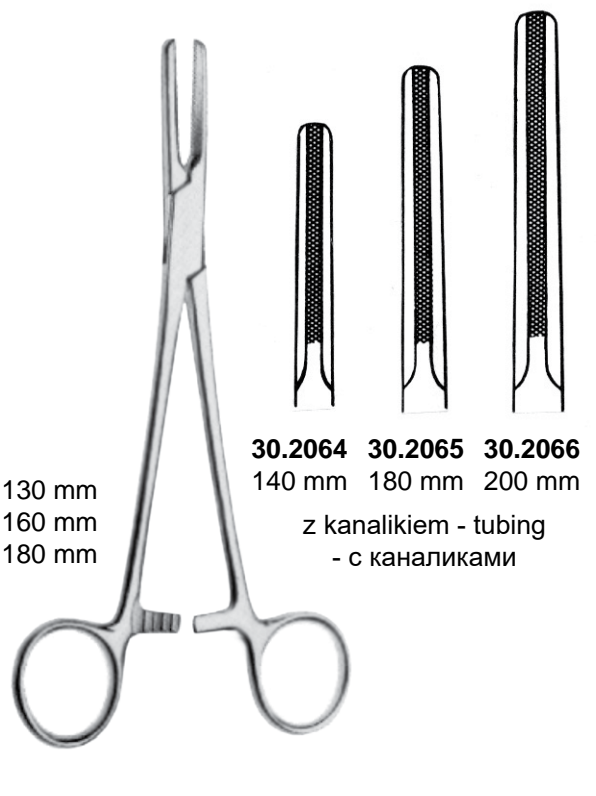
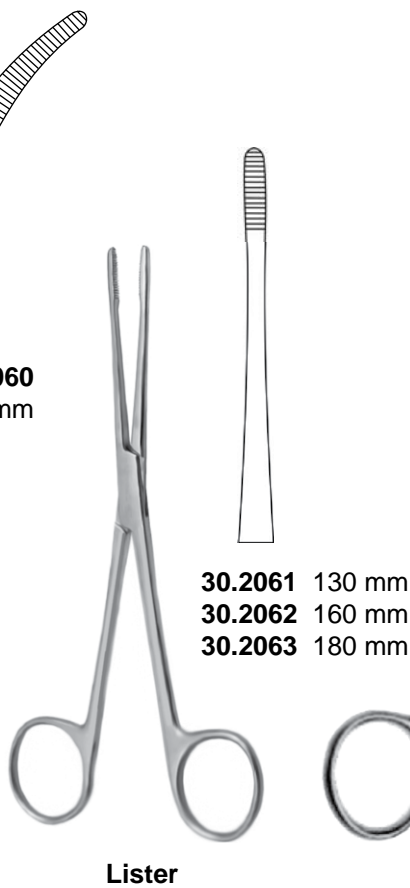
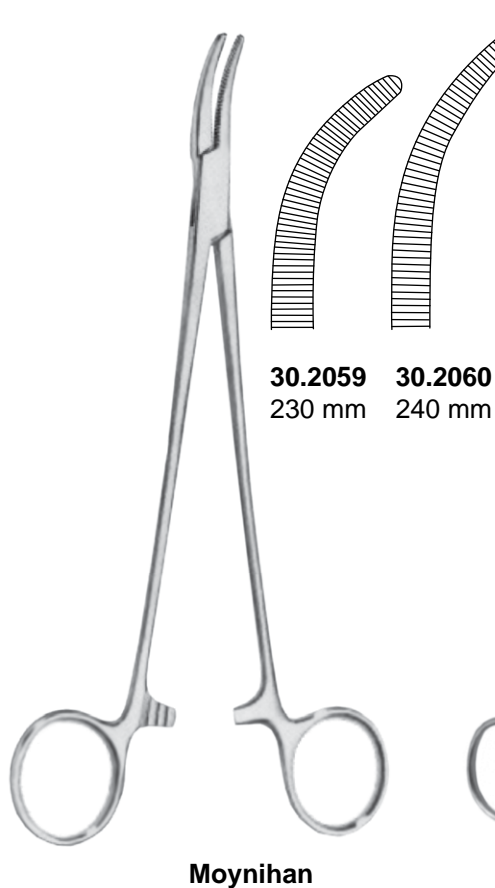
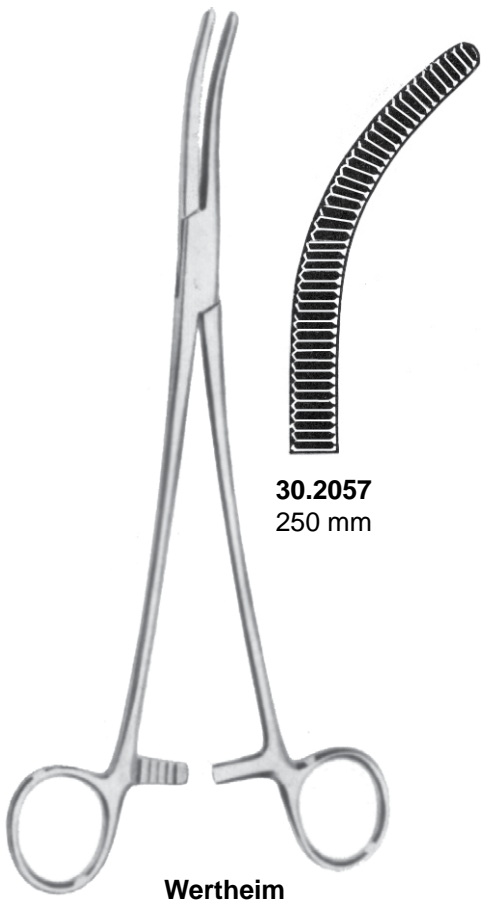



Lane
30.2067 200 mm

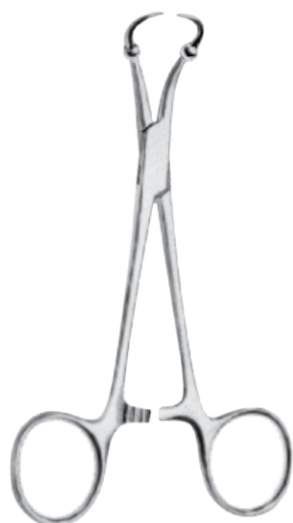

Roeder
30.2068 130 mm
30.2069 150 mm



Backhaus
30.2070 90 mm
30.2071 110 mm
30.2072 130 mm
30.2073 150 mm



Lorna
30.2074 100 mm
30.2075 130 mm

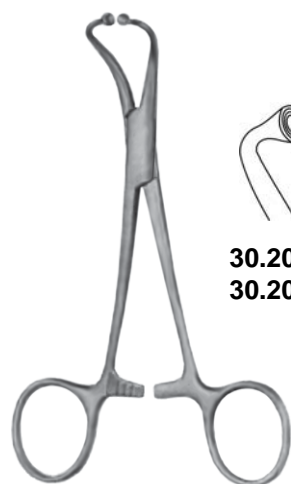

30.2076 110 mm
30.2077 130 mm



30.2078 110 mm
30.2079 130 mm



Doyen
30.2080 180 mm



Jones
30.2082 90 mm

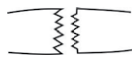

Ombredanne
30.2083 135 mm



30.2089.000
30.2089.250



Gross
200mm **30.2090.000**
250mm **30.2090.250**

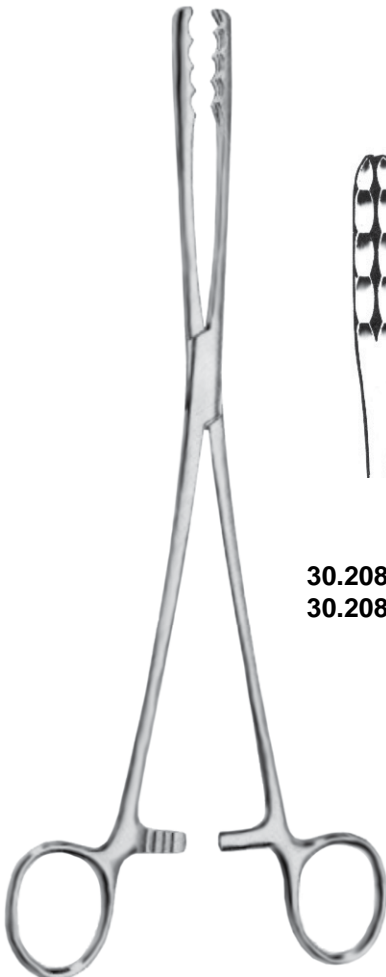

30.2084 200 mm
30.2085 250 mm

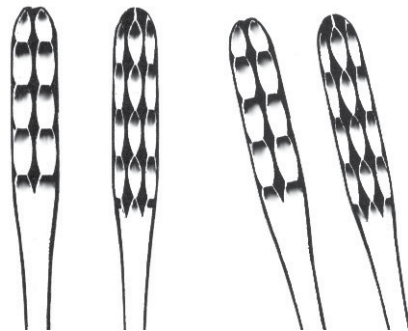

Ulrich
30.2086 200 mm
30.2087 250 mm



Pears
30.2088 145 mm



Thomas
30.2091 100 mm
30.2092 130 mm

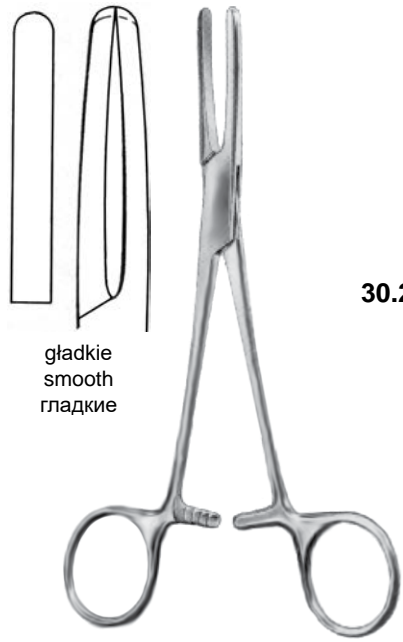

gładkie
smooth
гладкие

Presbyterian
30.2093 160 mm

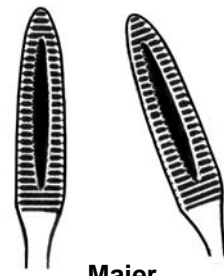

Maier

30.2094 220 mm 30.2096
30.2095 250 mm 30.2097
30.2095.270 270 mm 30.2097.270



Collin
30.2098 250 mm

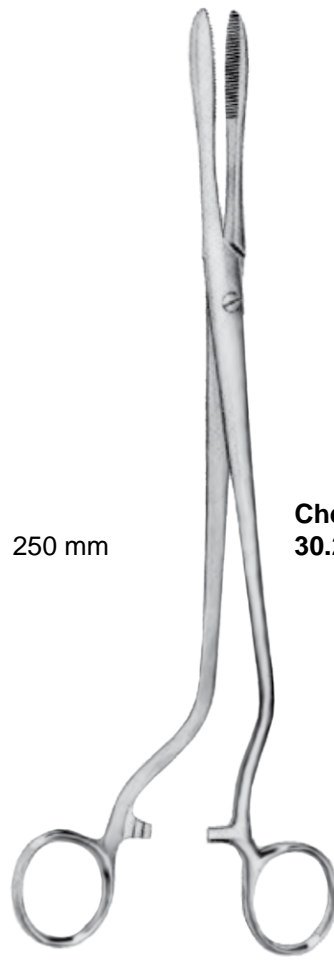

Cheron
30.2099 250 mm

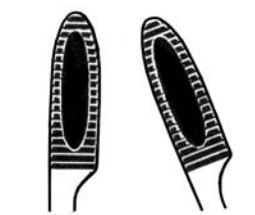
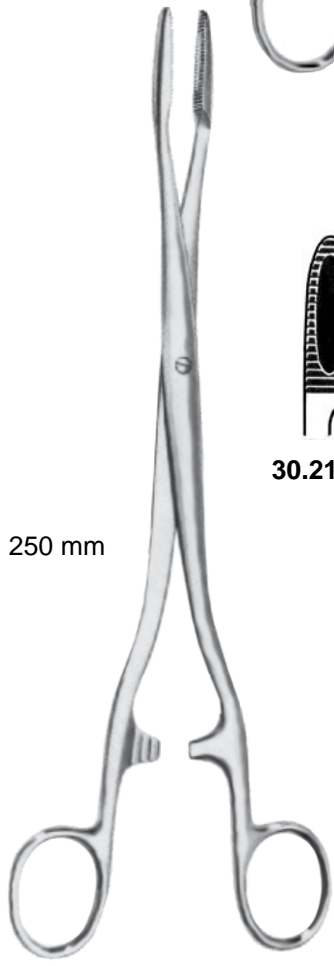

30.2100 30.2101
Duplay
250 mm

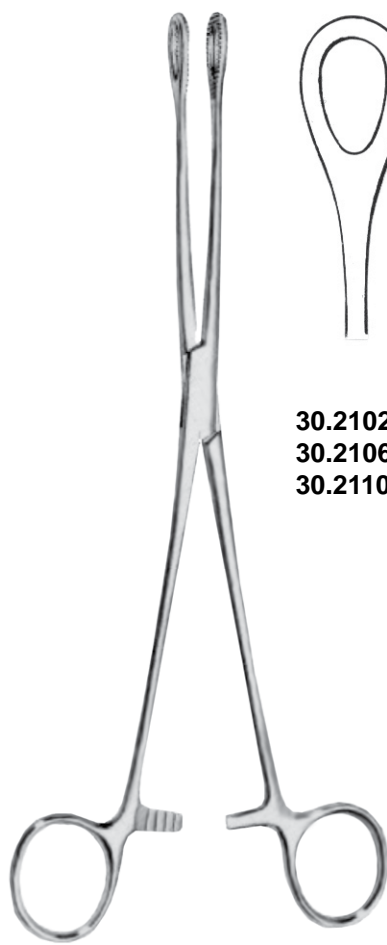

30.2102	30.2103	180 mm	30.2104	30.2105
30.2106	30.2107	200 mm	30.2108	30.2109
30.2110	30.2111	250 mm	30.2112	30.2113

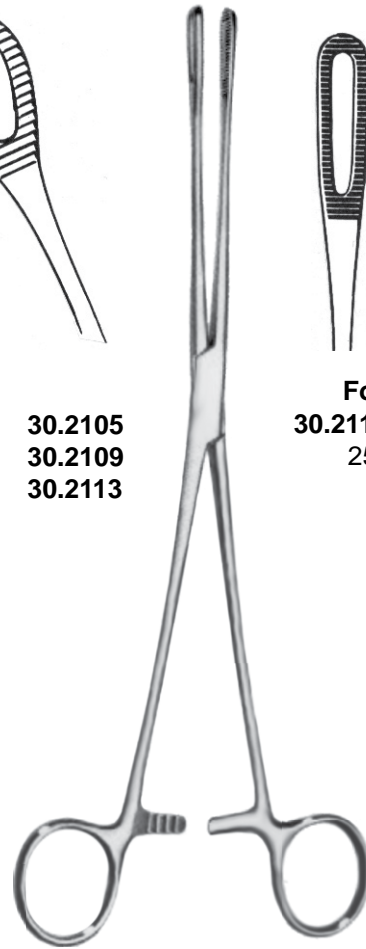

Foerster
30.2114 30.2115
250 mm

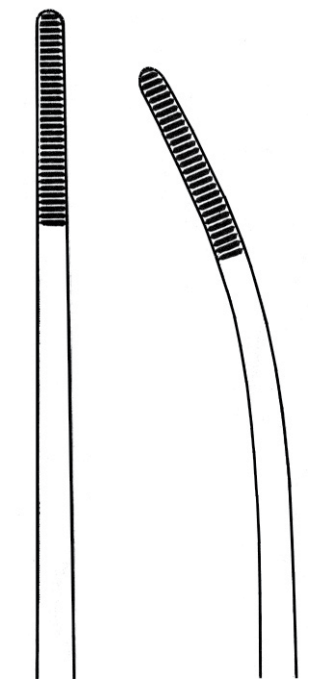
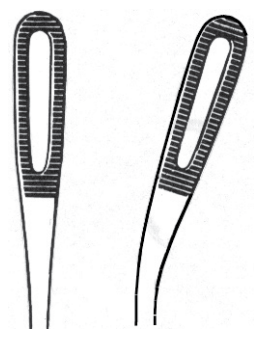

30.2117 **30.2119**
Bozemann 260 mm



Bozemann
-Douglas
30.2120
260 mm





Pelkmann
30.1935
250 mm

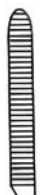

Pelkmann
30.1936
250 mm

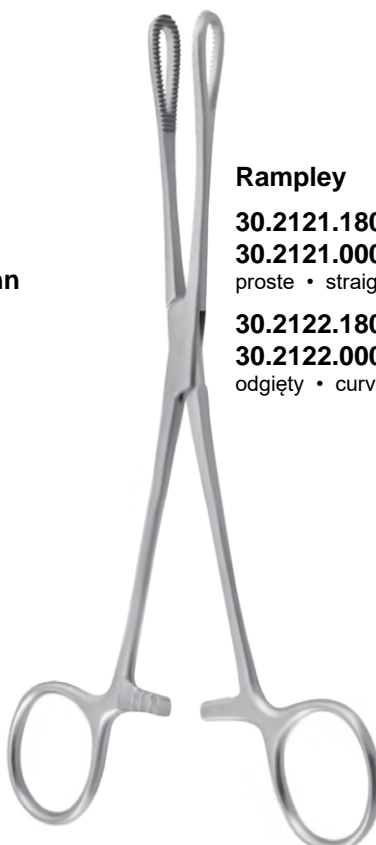

Rampley

30.2121.180 180 mm

30.2121.000 250 mm

proste • straight • прямые

30.2122.180 180 mm

30.2122.000 250 mm

odgięty • curved • изогнутые

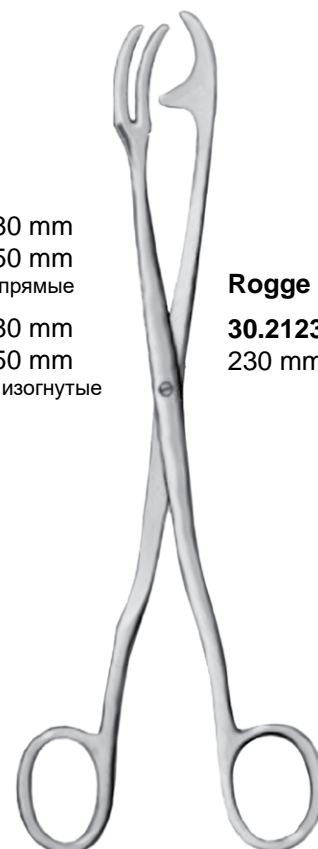

Rogge
30.2123
230 mm

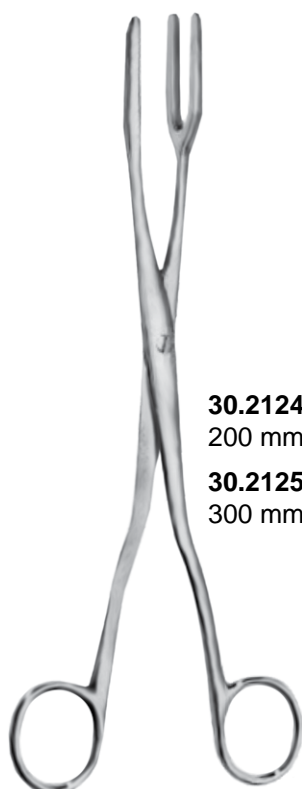

30.2124
200 mm

30.2125
300 mm



Davis

30.2127 160 mm

30.2128 200 mm

30.2129 240 mm





Pennington

30.2130.150 150 mm

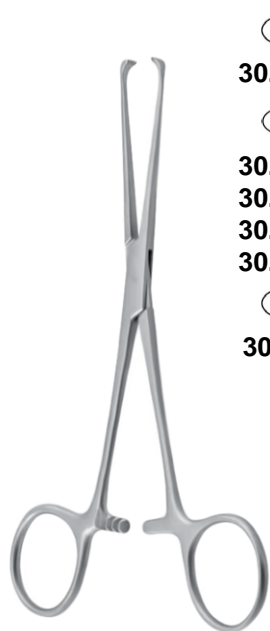
30.2130.000 200 mm



Allis

-  4:5
30.2131 150 mm
-  5:6
30.2132 150 mm
30.2133 190 mm
30.2134 250 mm
30.2135 220 mm
-  3:4
30.2136 150 mm



Allis-Baby

-  4:5
30.2137 130 mm
30.2138 140 mm



Allis-Adair

-  10:11
30.2139
 155 mm



Judd-Allis
30.2140 150 mm
30.2141 190 mm

3:4



Boys-Allis
30.2142 150 mm

5:6



Thoms-Allis
30.2143 200 mm

6:7



Lockwood-Allis
30.2144 160 mm
30.2145 200 mm

4:5

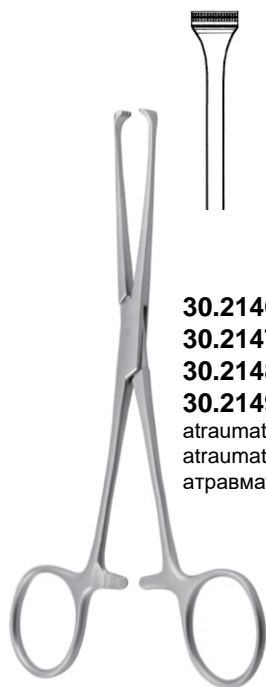

30.2146 155 mm
30.2147 200 mm
30.2148 220 mm
30.2149 250 mm
 atraumatyczne
 atraumatic
 атравматические

Allis

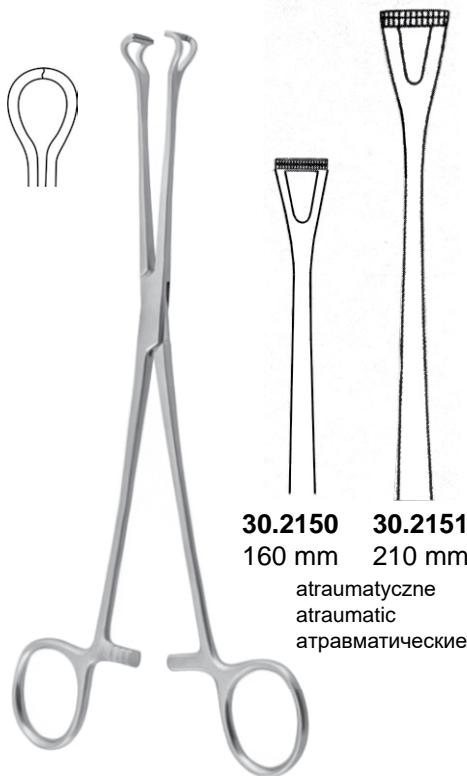

30.2150 160 mm
30.2151 210 mm
 atraumatyczne
 atraumatic
 атравматические

Babcock



30.2152 140 mm
30.2153 160 mm
30.2154 180 mm
30.2155 200 mm
30.2156 240 mm

Babcock



30.2158 150 mm
30.2159 210 mm
30.2160 290 mm
30.2161 350 mm
 bez trzpienia
 without pin
 без стержня

Payr



Benson
30.2157 155 mm



Williams
30.2166.016 160 mm

z utwardzoną wkładką • witch T/C jaws • с усиленными губками

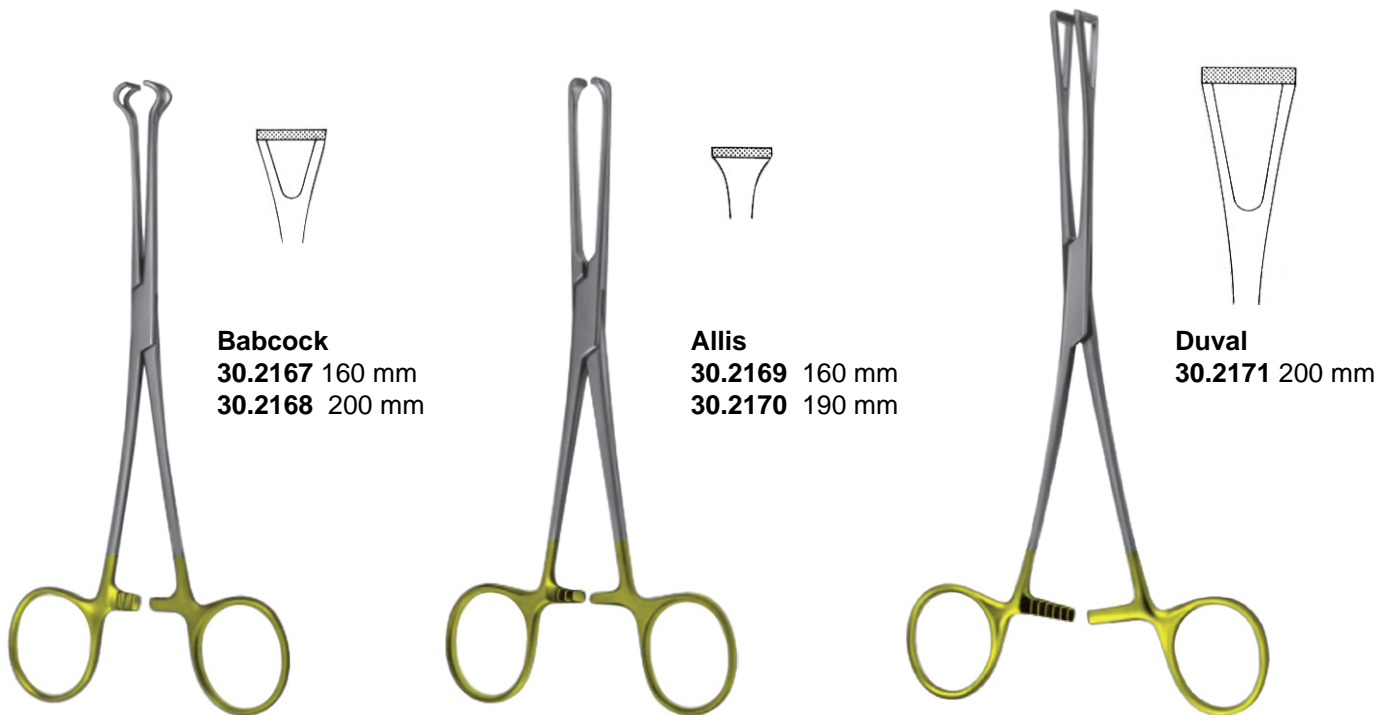

Babcock
 30.2167 160 mm
 30.2168 200 mm

Allis
 30.2169 160 mm
 30.2170 190 mm

Duval
 30.2171 200 mm

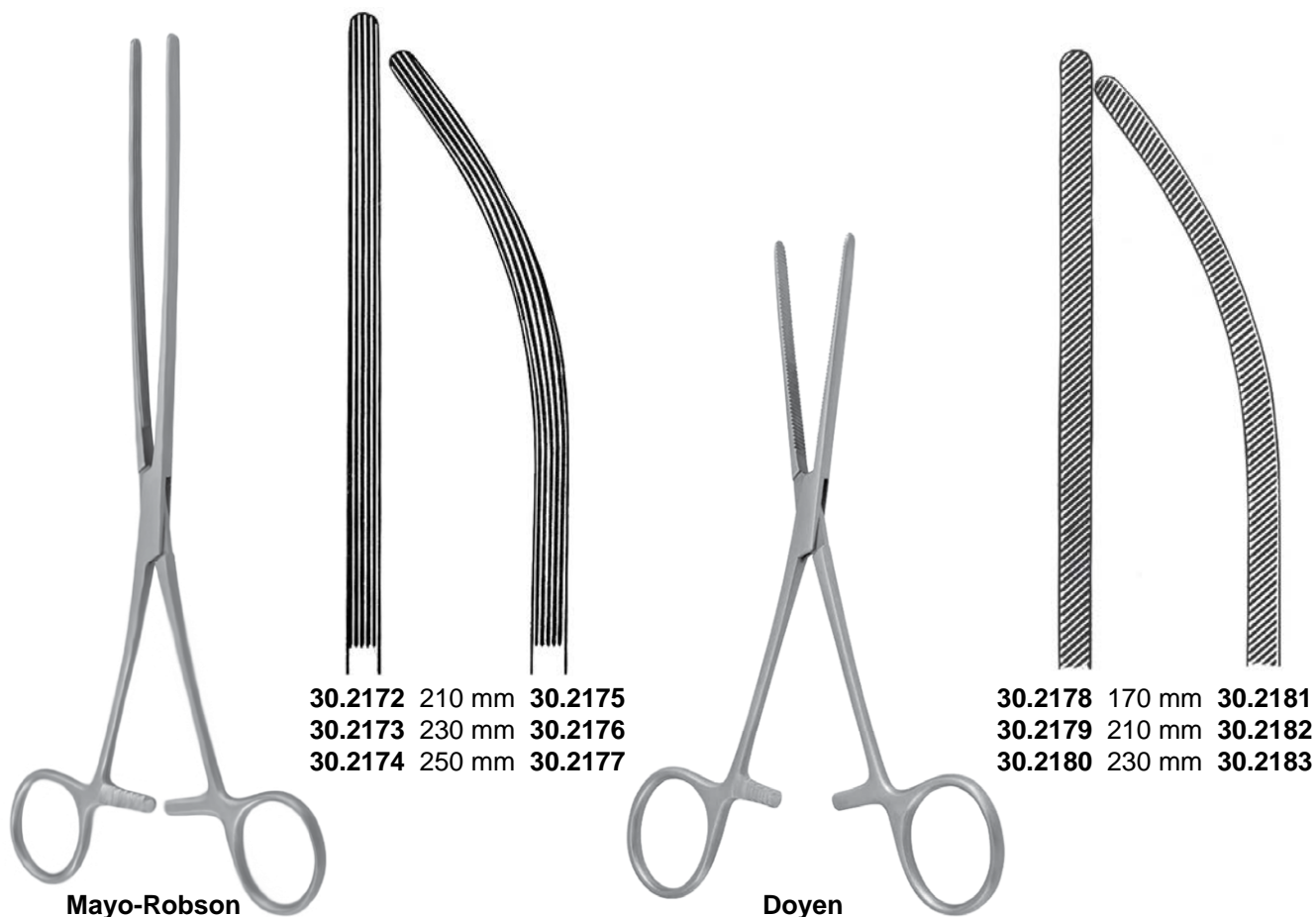

30.2172 210 mm 30.2175
 30.2173 230 mm 30.2176
 30.2174 250 mm 30.2177

30.2178 170 mm 30.2181
 30.2179 210 mm 30.2182
 30.2180 230 mm 30.2183

Mayo-Robson

Doyen

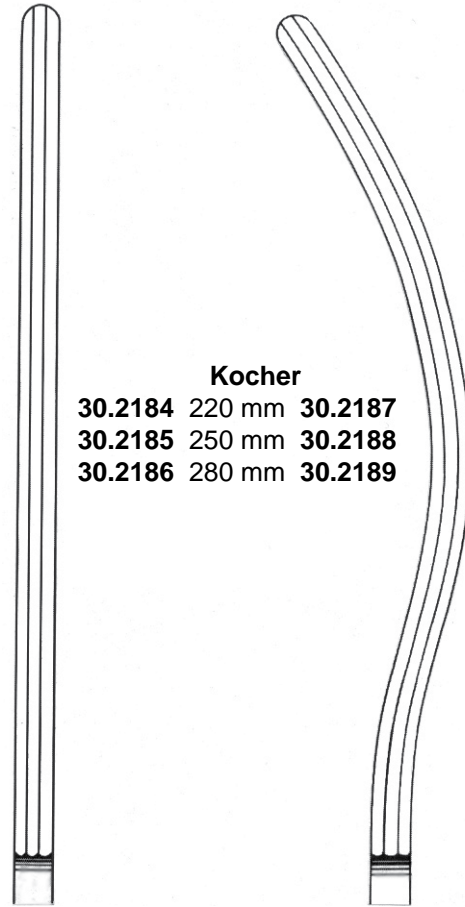

Kocher
30.2184 220 mm **30.2187**
30.2185 250 mm **30.2188**
30.2186 280 mm **30.2189**

atraumatyczne • atraumatic • атравматические

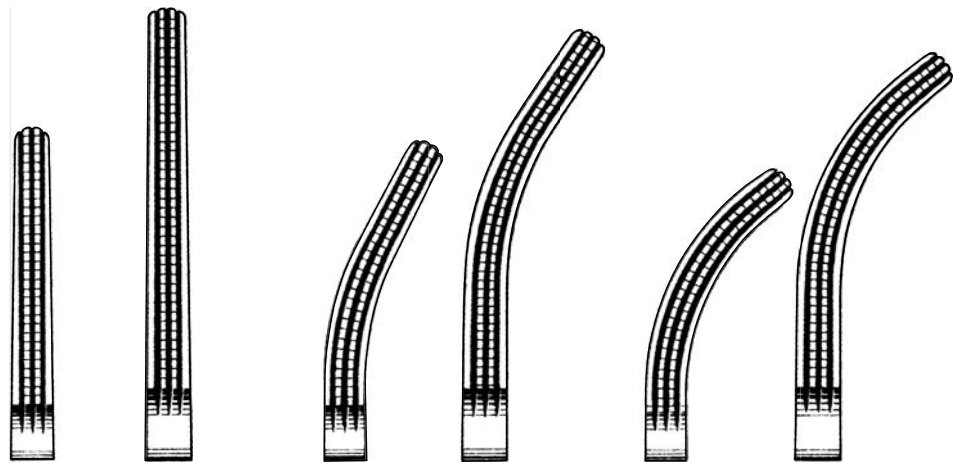

30.1947 220 mm
30.1948 255 mm

Rogers
30.1949 215 mm
30.1950 250 mm

30.1951 210mm
30.1952 245 mm

atraumatyczne • atraumatic • атравматические

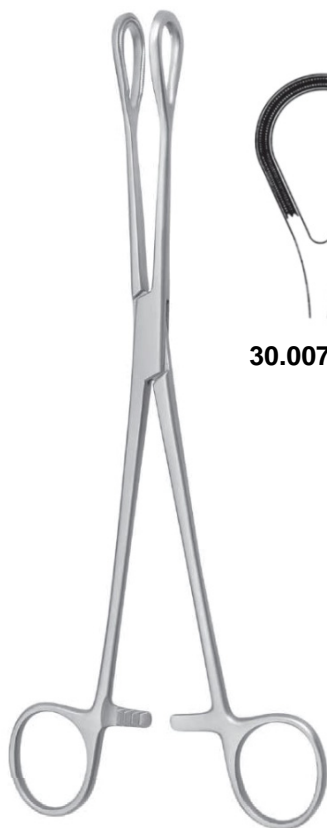

30.0079.025 25cm



30.0079.026 26cm

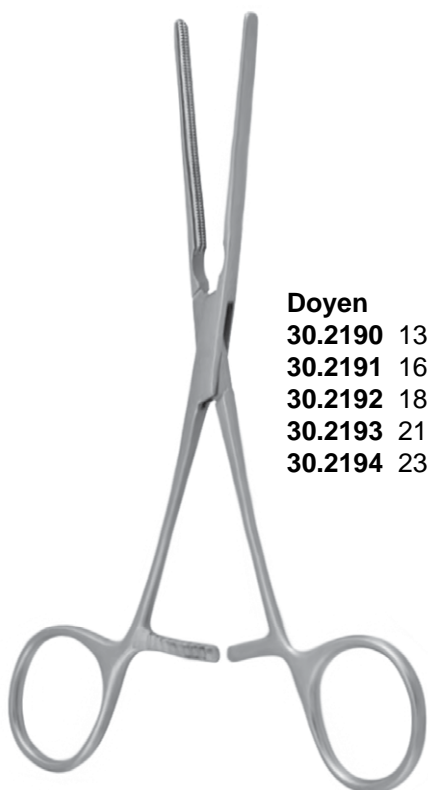

Doyen
30.2190 130 mm
30.2191 160 mm
30.2192 180 mm
30.2193 210 mm
30.2194 230 mm

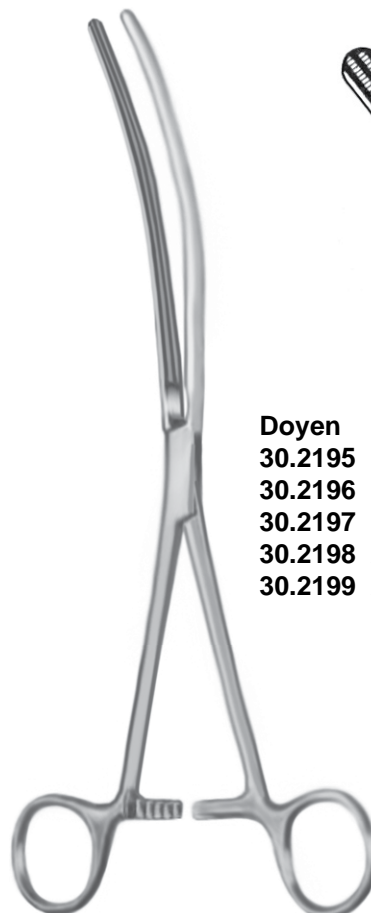

Doyen
30.2195 130 mm
30.2196 160 mm
30.2197 180 mm
30.2198 210 mm
30.2199 230 mm

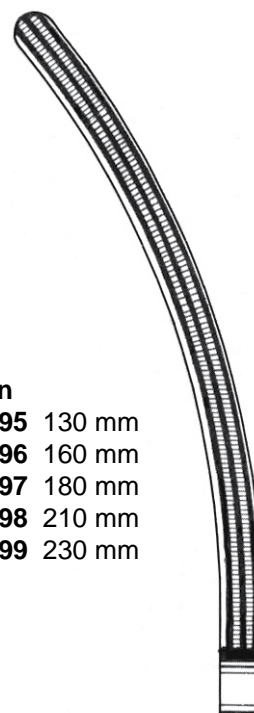

atraumatyczne - atraumatic- атравматические

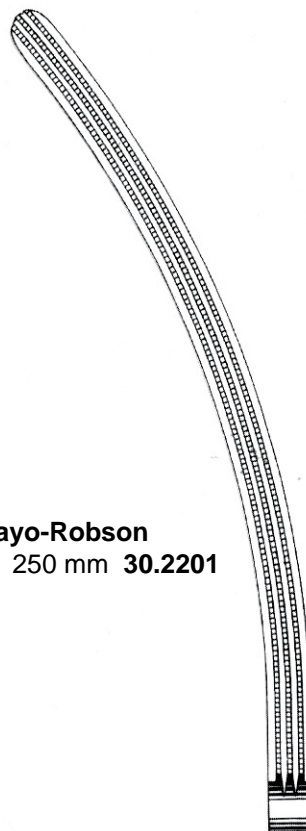

Mayo-Robson
 30.2200 250 mm 30.2201

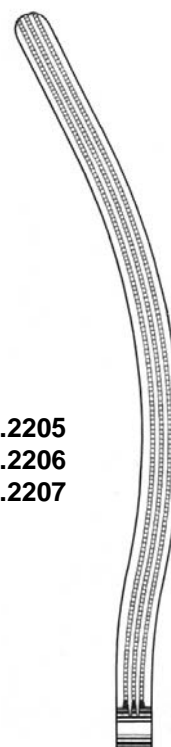
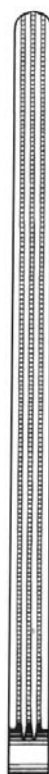

Kocher
 30.2202 220 mm 30.2205
 30.2203 250 mm 30.2206
 30.2204 280 mm 30.2207

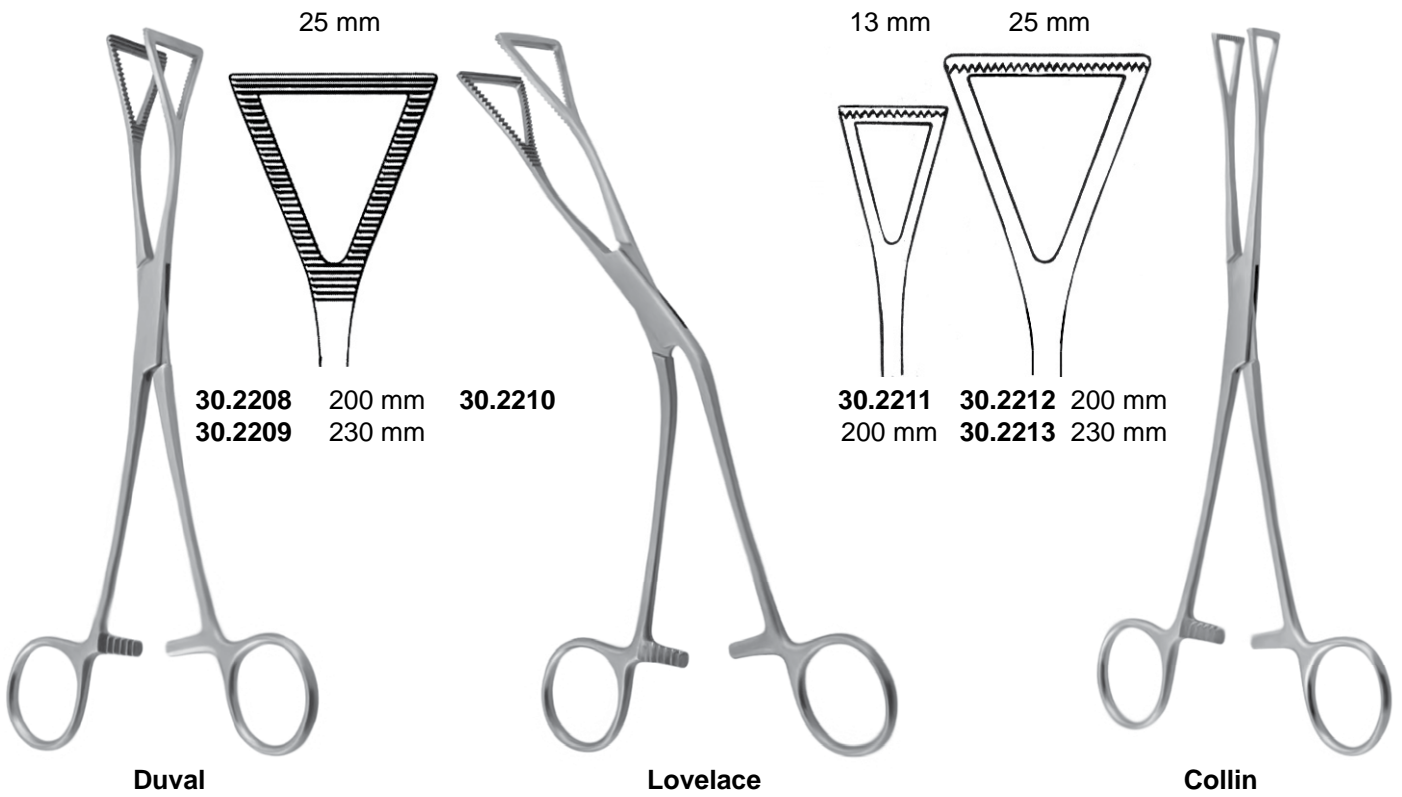

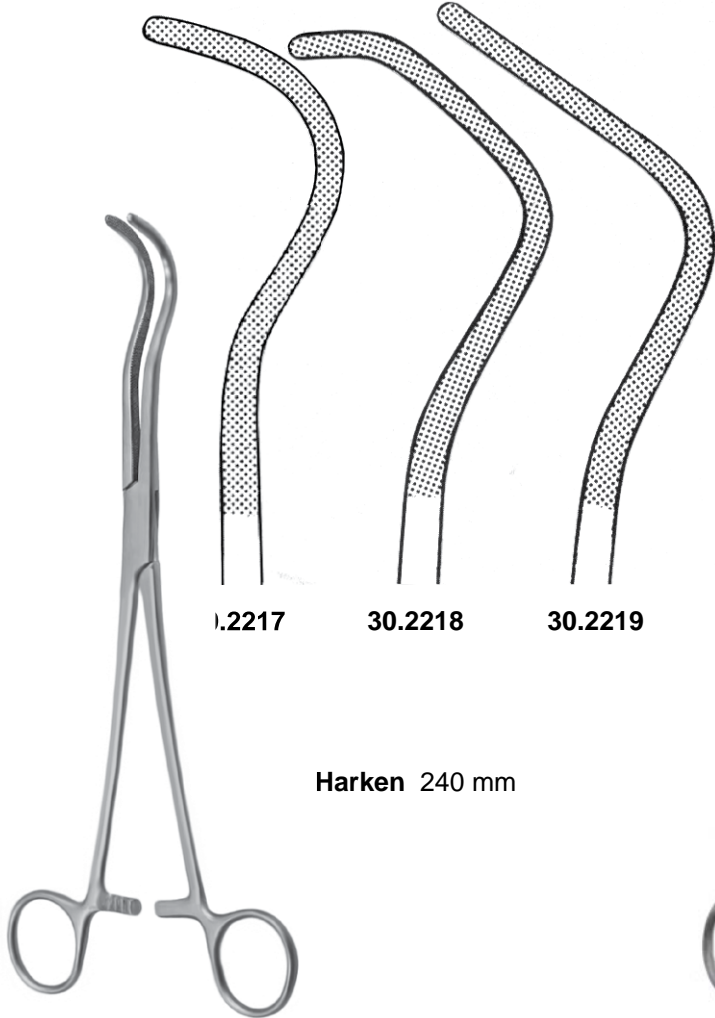

1.2217

30.2218

30.2219

Harken 240 mm

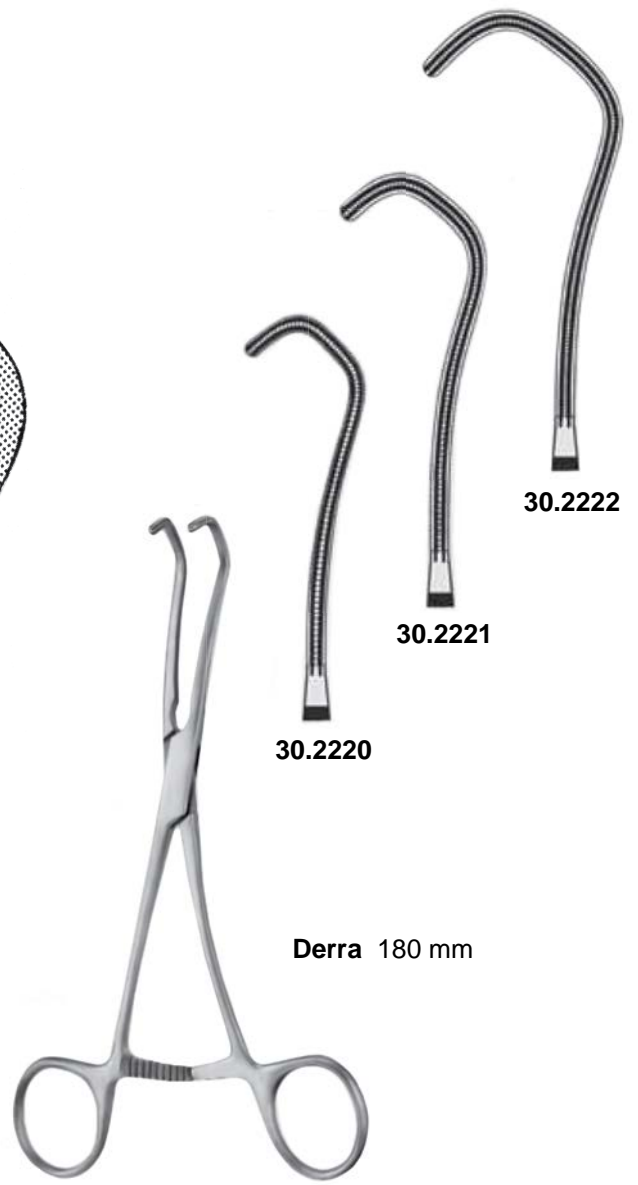

30.2220

30.2221

30.2222

Derra 180 mm



Trousseau
30.2223 140 mm



Laborde
30.2224 140 mm



Satinsky 265 mm

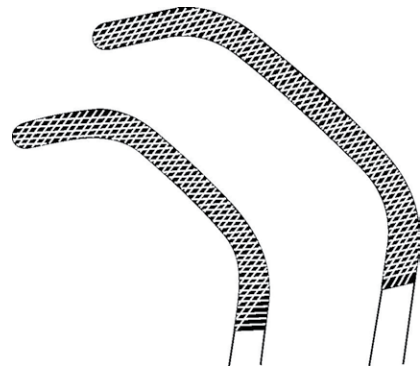
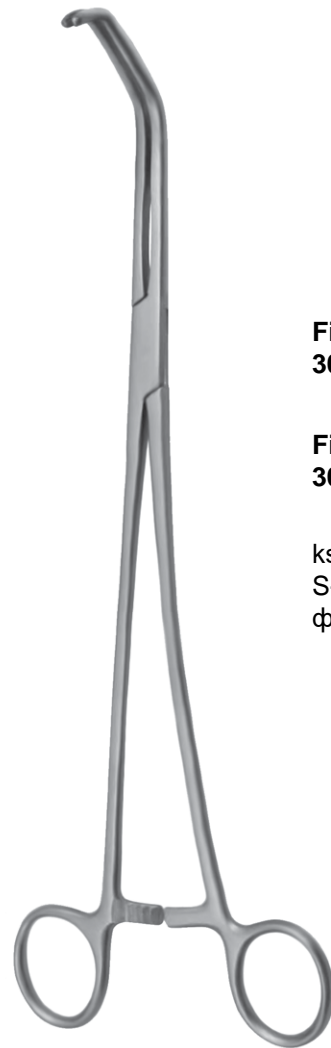

Fig. 1
30.2225

Fig. 2
30.2226



Satinsky 265 mm

Fig. 1
30.2227

Fig. 2
30.2228

kształt S
S-shaped
форма S



Baby-Satinsky
30.2229 150 mm



Schröder
30.2512
proste
straight
прямые

30.2513
odgięte do przodu
curved forwards
изогнутые вперёд
240 mm

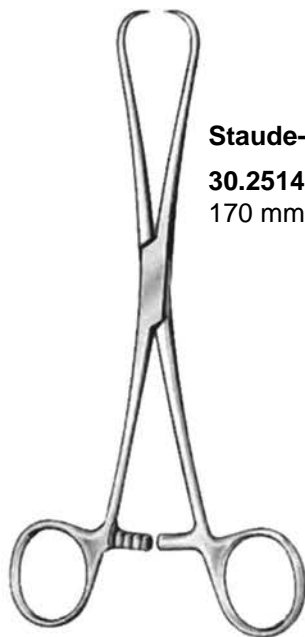

Staude-Moore
30.2514
170 mm

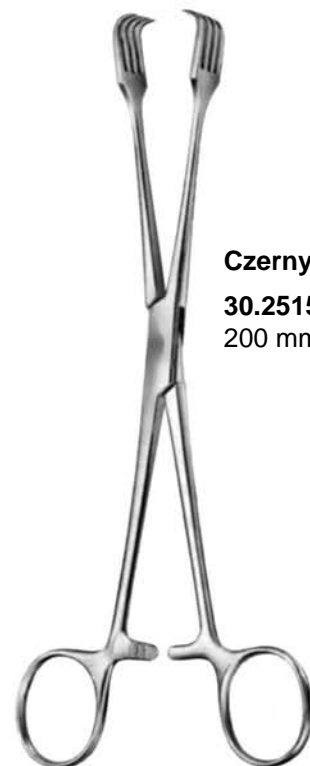

Czerny
30.2515
200 mm



Schröder-Brown
30.2516
ostrzy · sharp · острый
30.2517
tępy · blunt · тупый
250 mm

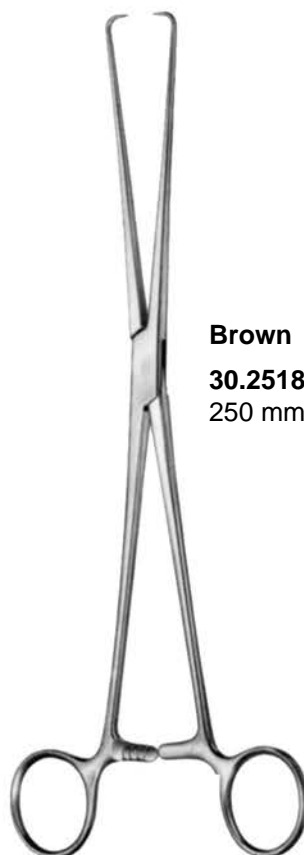

Brown
30.2518
250 mm



Teale
30.2519
230 mm



Duplay
30.2520
kształt S
S shaped
форма S
250 mm



Skene
30.2521
240 mm



Jacobs
30.2522
proste • straight • прамые
30.2523
odgięte do przodu
curved forwards
изогнутые вперёд
30.2524
odgięte w bok
curved sideways
изогнутые на бок
210 mm

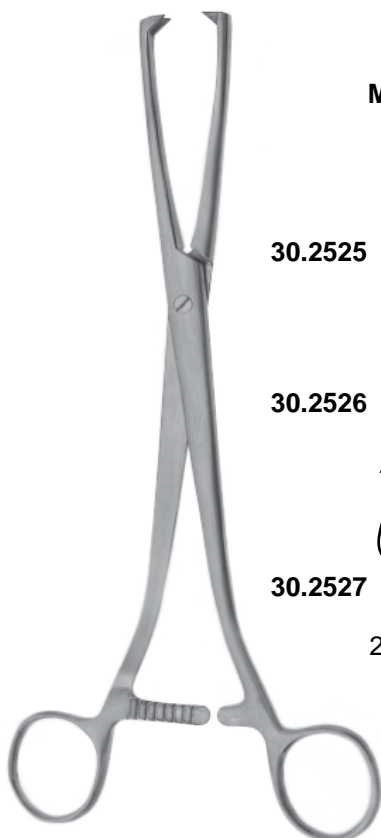

Museux



30.2525 6 mm **30.2528**



30.2526 8 mm **30.2529**



30.2527 10 mm **30.2530**



240 mm



odgięte w bok
curved sideways
изогнутые на бок



Pozzi
30.2590.180
180 mm
30.2590.250
250 mm



De Bakey
190 mm

30.2230
ø 0,5 mm

30.2231
ø 1,0 mm

30.2232
ø 1,5 mm

30.2233
ø 2,0 mm

30.2234
ø 2,5 mm

30.2235
ø 3,0 mm

30.2236
ø 3,5 mm

30.2237
ø 4,0 mm

30.2238
ø 4,5 mm

30.2239
ø 5,0 mm

30.2240
ø 7,0 mm

30.2241
ø 9,0 mm



Nabatoff
30.2242

135x100x25 mm

Komplet nie zawiera końcówki ø15 mm
 Set does not include the olive of ø15 mm
 Набор не включает оливы ø15 мм

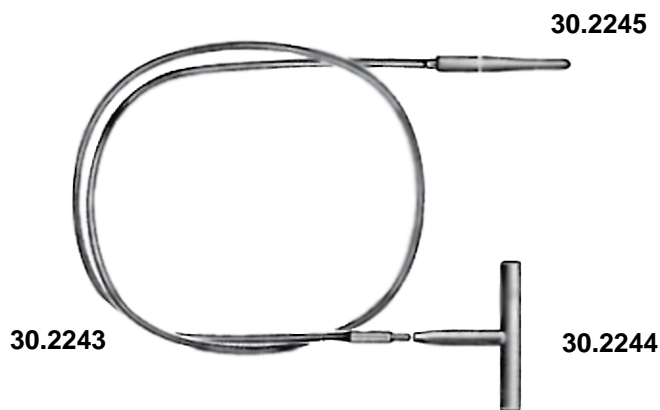

30.2243

30.2244

30.2247
ø 3,0 mm

30.2248
ø 6,0 mm

30.2249
ø 9,0 mm

30.2250
ø 12,0 mm

30.2251
ø 15,0 mm



30.3510.000 140 mm



30.3510.115 115 mm
30.3510.130 130 mm
30.3510.145 145 mm
30.3510.160 160 mm
30.3510.180 180 mm
30.3510.200 200 mm



30.3511.115 115 mm
30.3511.130 130 mm
30.3511.145 145 mm
30.3511.160 160 mm
30.3511.180 180 mm



30.3512.160 160 mm



30.3512.200 200 mm



30.2266
Ø 4 mm

Mayo 320 mm
giętka
malleable
пружинчатая



30.2267 4 mm **30.2268** 5 mm **30.2269** 6 mm

Desjardins 280 mm
elastyczna
flexible
эластичная

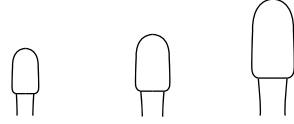

1 mm
30.2270

2 mm
30.2271

3 mm
30.2272

4 mm
30.2273

5 mm
30.2274

6 mm
30.2275

7 mm
30.2699

1/1

8 mm
30.2276

9 mm
30.2277

10 mm
30.2278

11 mm
30.2279

12 mm
30.2280

13 mm
30.2281

1/1

Bakes
300 mm



30.2252
230 mm

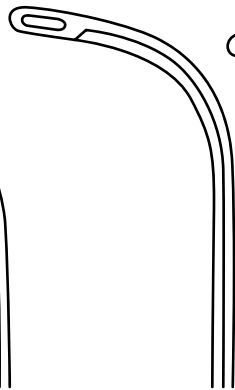

30.2253
220 mm

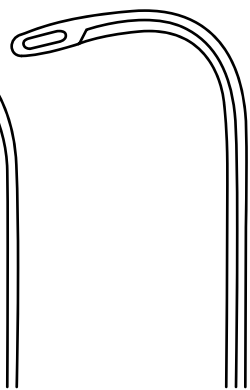

30.2254
220 mm

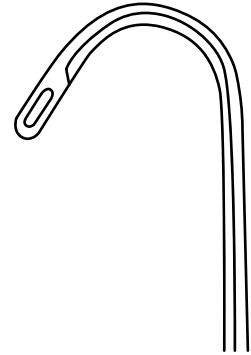

30.2255
220 mm

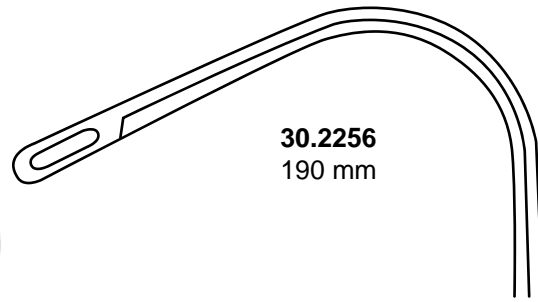

30.2256
190 mm

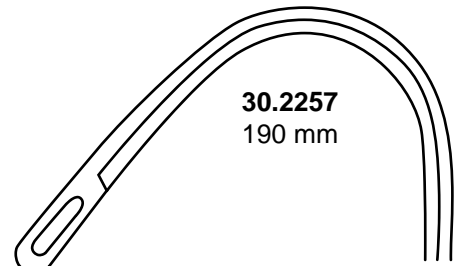

30.2257
190 mm



30.2258

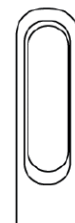

30.2259



Mixer
30.2261 220 mm

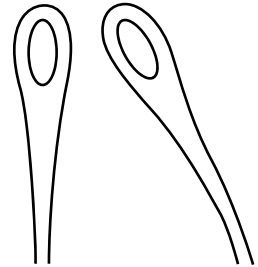

Blake 200 mm
30.2262 30.2263

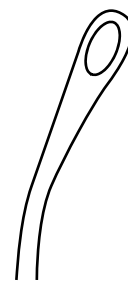
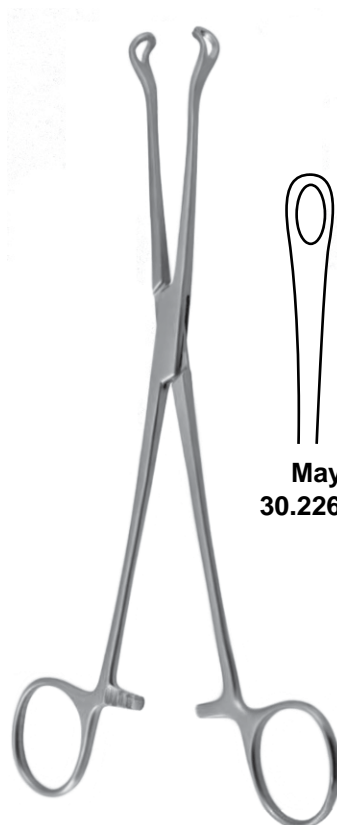

Mayo-Blake 200 mm
30.2264 30.2265



Rochester
30.1937
230 mm



Best
30.1938
230 mm



Bevan
30.1939
210 mm



Lewkowitz
30.1940 245 mm **30.1941**



Young
30.1942
200 mm

hemoroidalne • haemorrhoidal • геморроидальные



McGivney
30.1943
 190 mm



McGivney
30.1944
 190 mm



Laufer
30.1945
 200 mm



Pratt
30.1946
 150 mm

do wprowadzania cewników • catheter • для поставки катетеров



Magill-Baby
30.1953
 150 mm
 dla dzieci
 for children
 для детей



Magill
30.1954
 200 mm
 dla dzieci
 for children
 для детей



Magill
30.1955
 250 mm
 dla dorosłych
 for adults
 для взрослых



Michel
30.4230
125 mm



Collin
30.4231
135 mm



Michel
30.4233
120 mm



Michel
30.4234
120 mm



Hagenbarth
30.4235
125 mm



Wachenfeldt
30.4236
125 mm





tępy
blunt
тупой

Graham
30.1431
165 mm



ostry
sharp
острый

Adson
30.1432
200 mm



tępy
blunt
тупой

Adson
30.1433
200 mm

13x6 mm



Hak do tarczycy
Thyroid gland retractor
Ранорасширитель для
щитовидной железы

Schoenborn
30.1434
210 mm



News
30.1435
150 mm

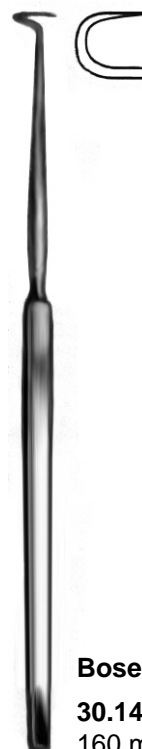

Bose
30.1436
160 mm

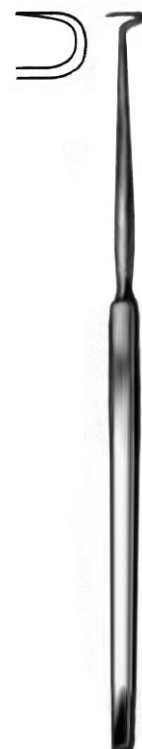

Bose
30.1437
160 mm

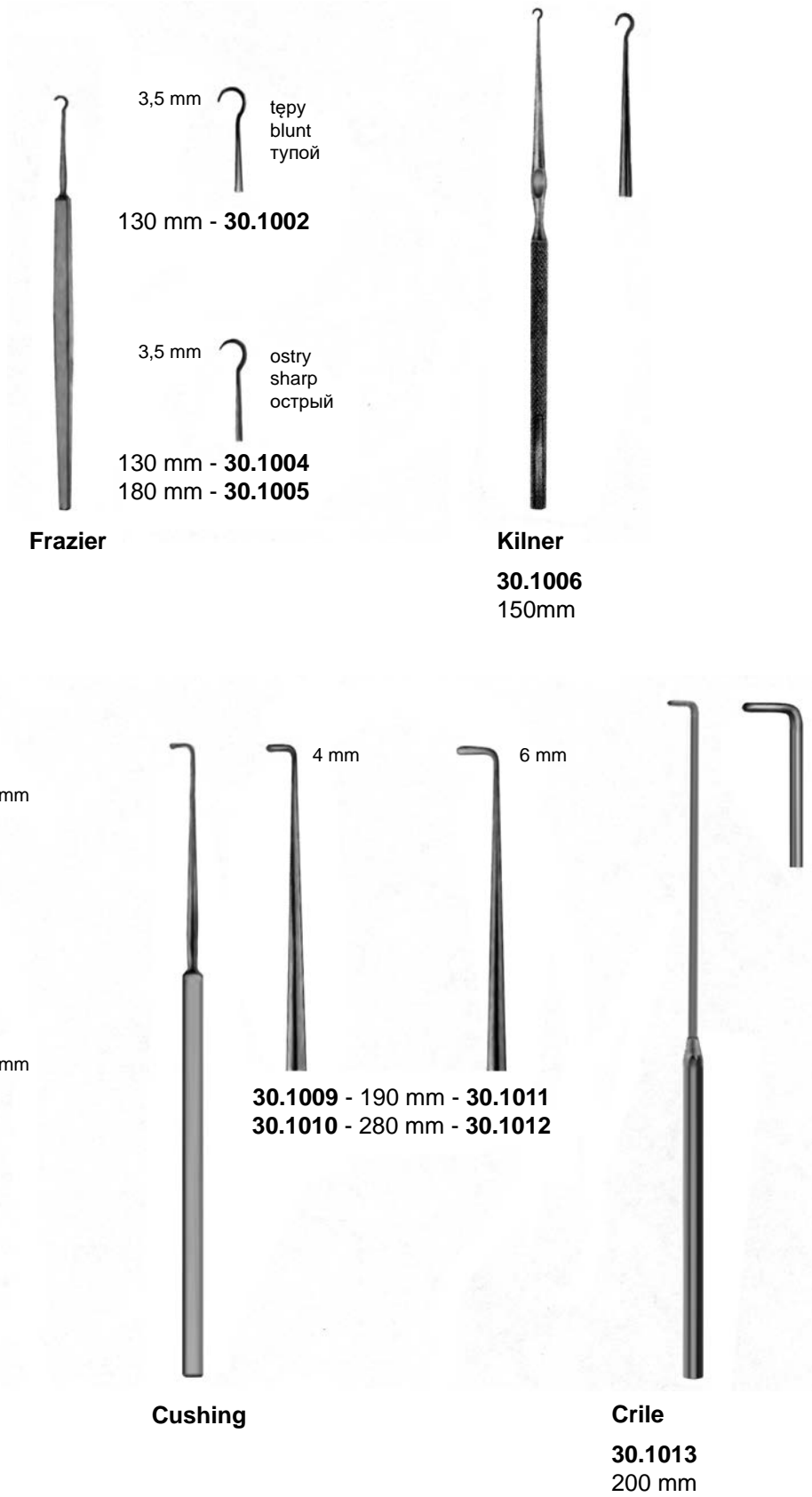



30.1016
160 mm



160 mm



160 mm

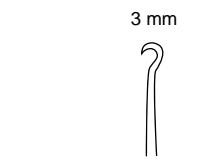
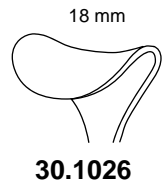

30.1037

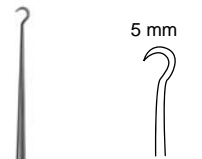

30.1038

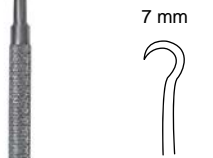

30.1039

Kleinert-Kutz
130 mm



Barsky
30.1041
150 mm



30.1653.002

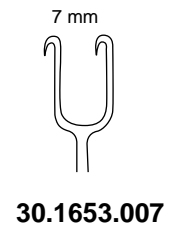

Joseph
160 mm



30.1653.005



30.1653.010

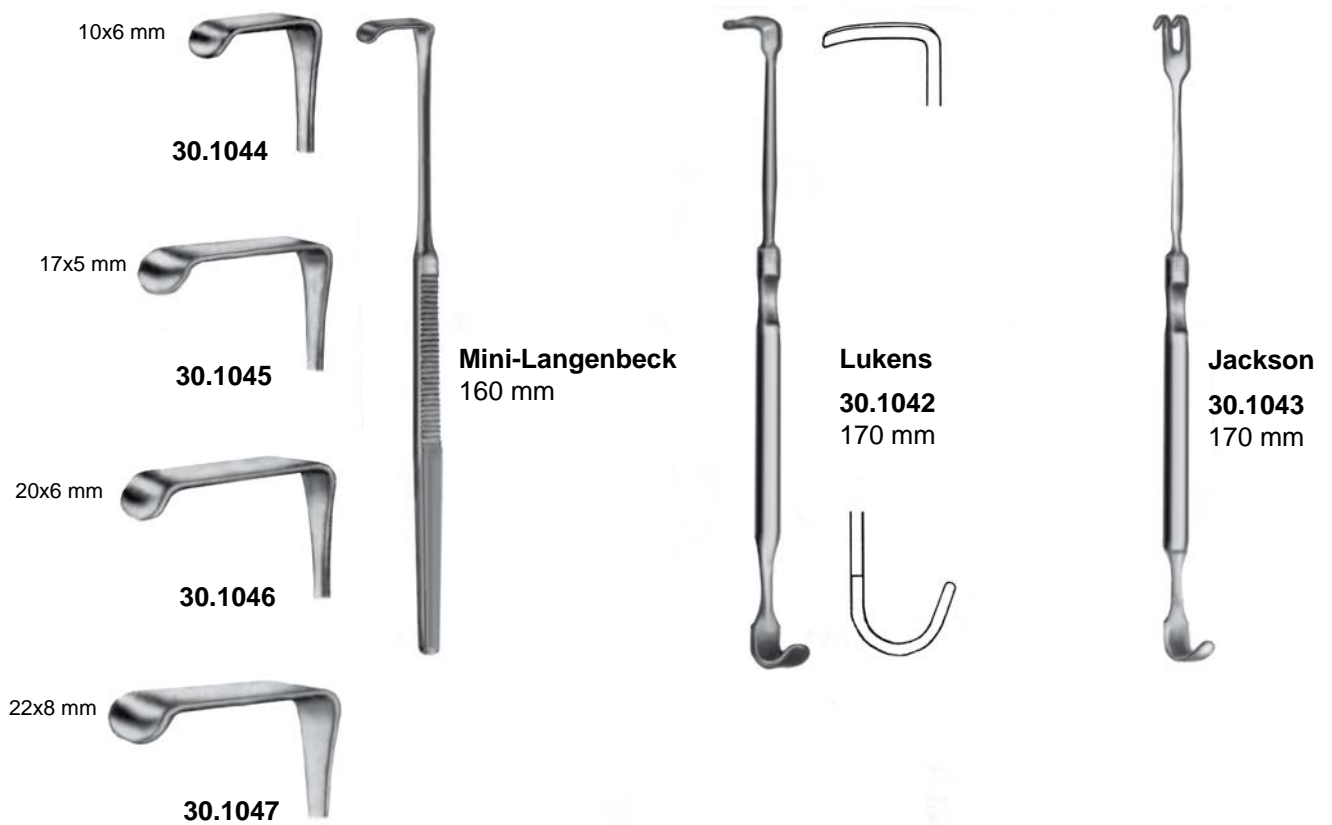
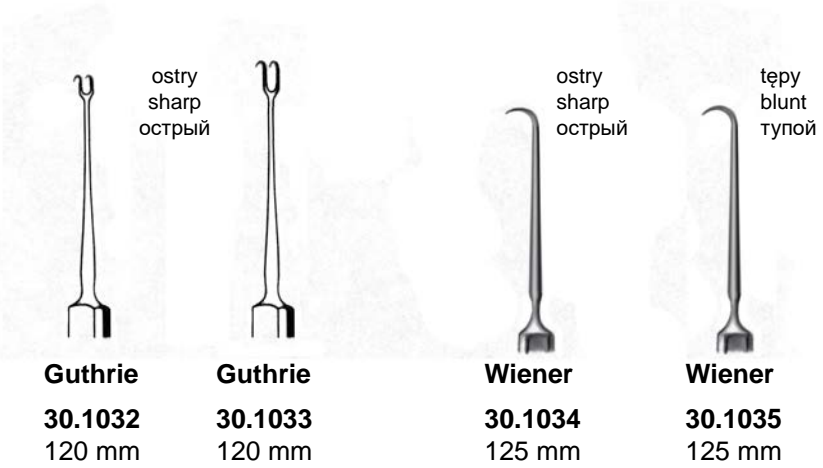
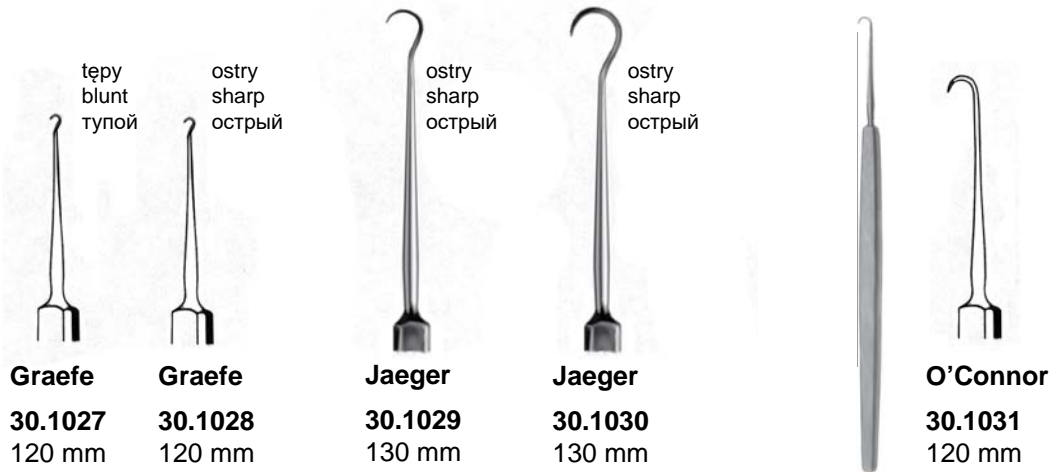



160 mm

tępy
blunt
тупой



30.1048



30.1049



30.1050



30.1051

ostry
sharp
острый



30.1052



30.1053



30.1054



30.1055



30.1056



30.1057



30.1058



30.1059

tępy
blunt
тупой



30.1060



30.1061



30.1062



30.1063

ostry
sharp
острый



160 mm



160 mm

tępy
blunt
тупой



30.1064



30.1065



30.1066



30.1067

giętki
flexible
гибкий

ostry
sharp
острый



30.1068



30.1069



30.1070



30.1071



Volkman
115 mm

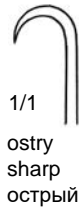
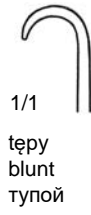

Iterson
160 mm



Meyerding
200 mm



Jackson
30.1088
150 mm



30.1089
135 mm



Bergmann
30.1090
140 mm



- 30.1091** 8 mm
- 30.1092** 11 mm
- 30.1093** 15 mm
- 30.1094** 17 mm
- 30.1095** 20 mm
- 30.1096** 23 mm

Gil-Vernet
240 mm



- 30.1098** 15 mm
- 30.1099** 20 mm

Love (Morse)
250 mm



12x14 mm

Little
30.1103
200 mm



Cushing
200 mm

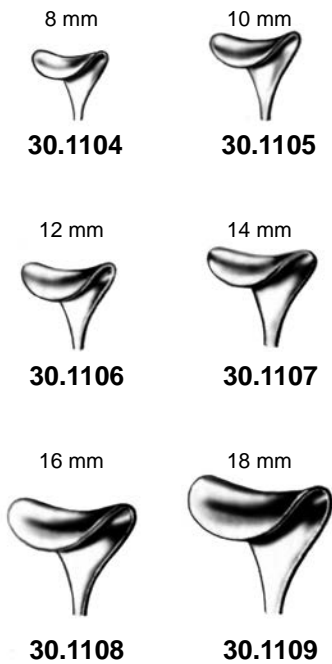

Cushing
240 mm

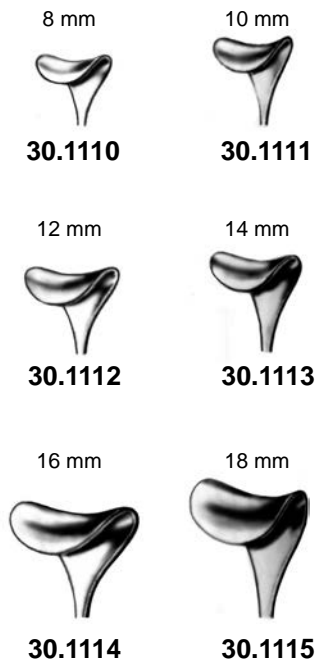

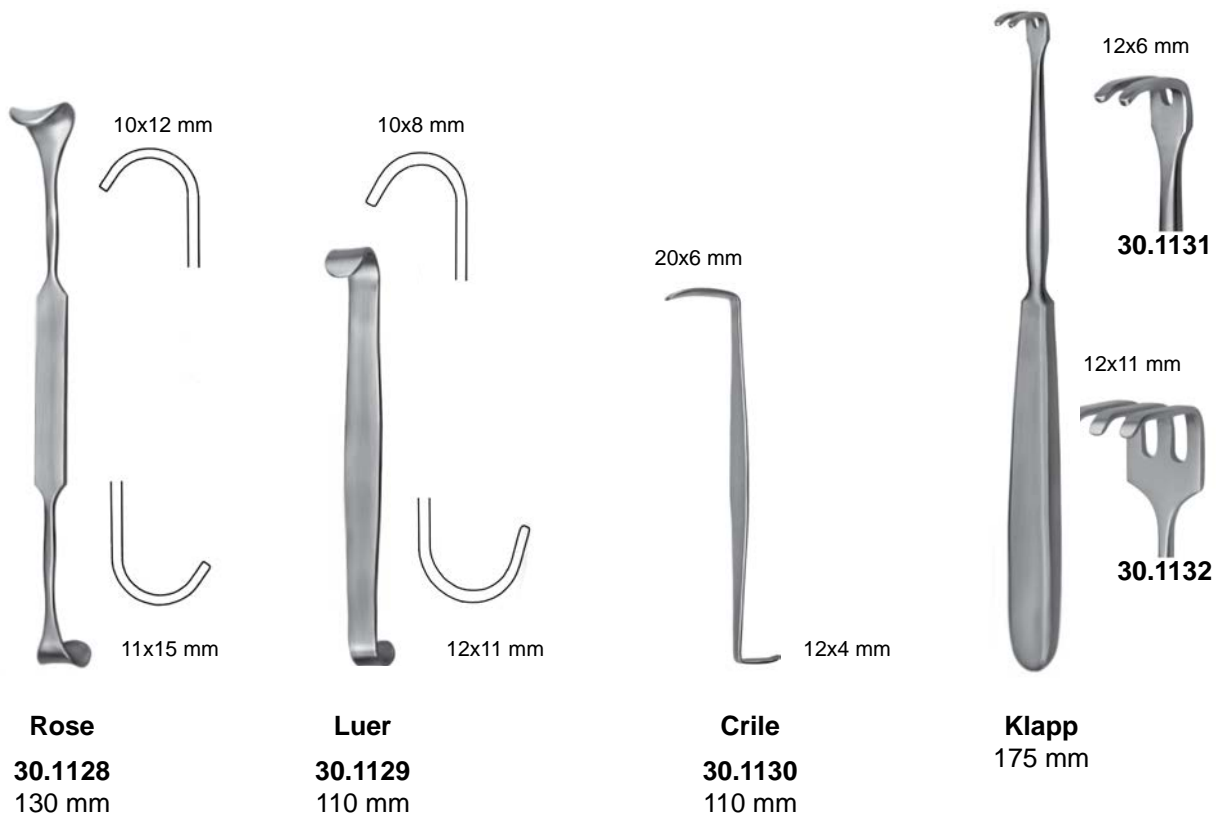

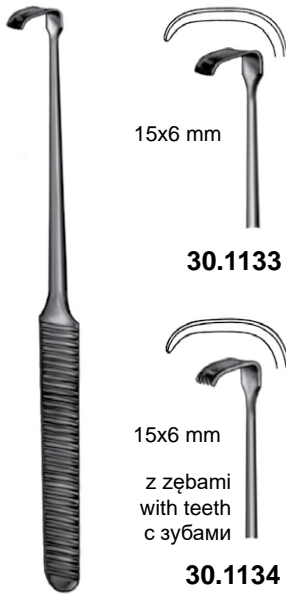

Strandell-Stille
190 mm



Cushing
30.1135
200 mm

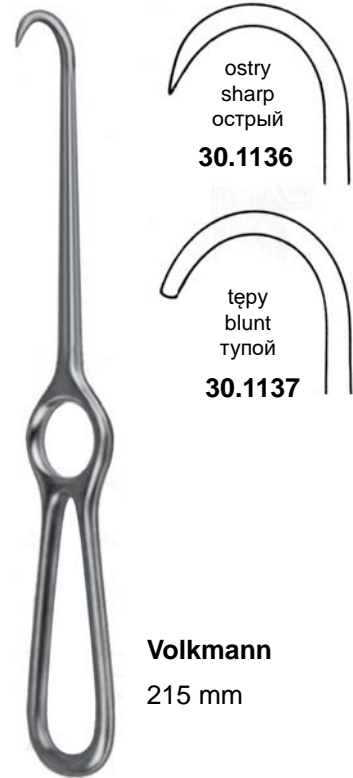

Volkmann
215 mm



Volkmann
215 mm

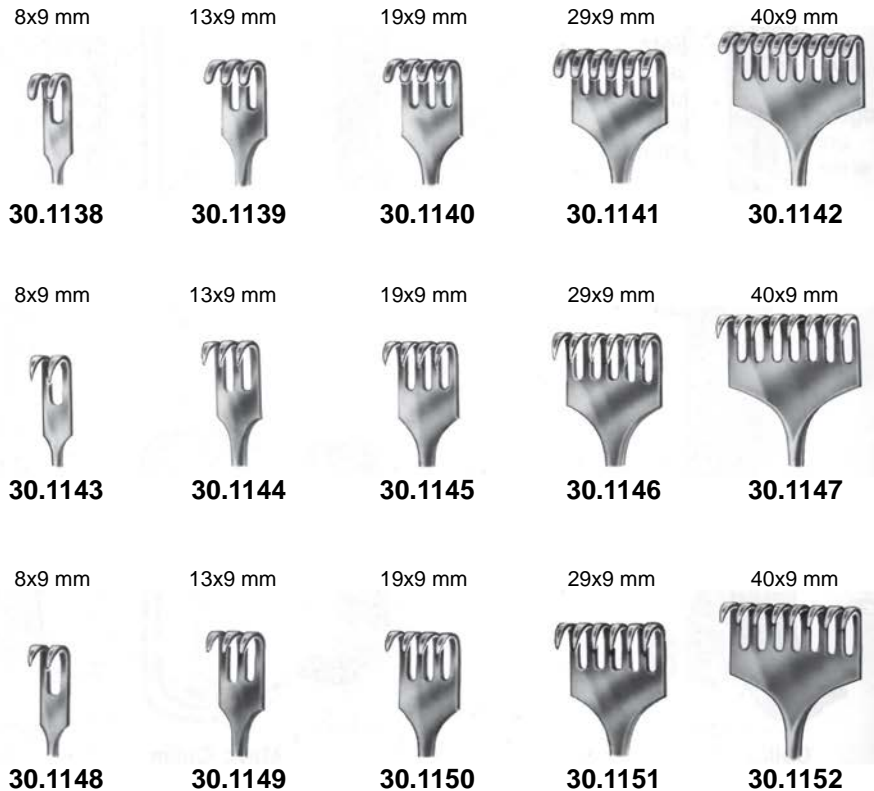

tępy
blunt
тупой

ostry
sharp
острый

półostry
semi-sharp
полуострый

Volkman
230 mm

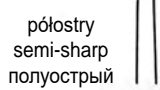

Kocher
220 mm

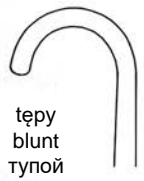



tępy
blunt
тупой



Kocher
30.1167
215 mm



ostry
sharp
острый



Kocher
30.1173
215 mm

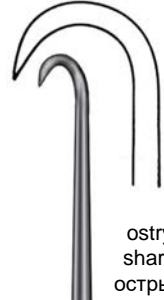

ostry
sharp
острый



Kocher
30.1180
215 mm



tępy
blunt
тупой



Kocher
30.1181
215 mm

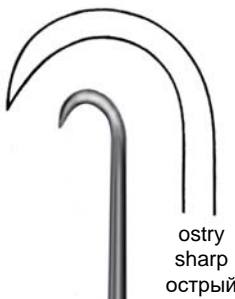

ostry
sharp
острый



30.1182
245 mm

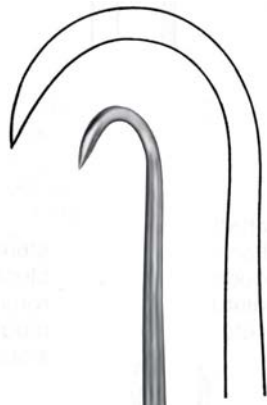

ostry
sharp
острый



Volkman
30.1183
215 mm



tępy
blunt
тупой



Volkman
30.1184
215 mm



40.7216
230 mm

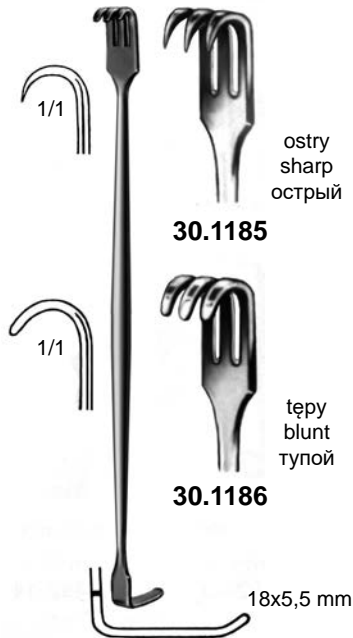

Senn-Miller
160 mm

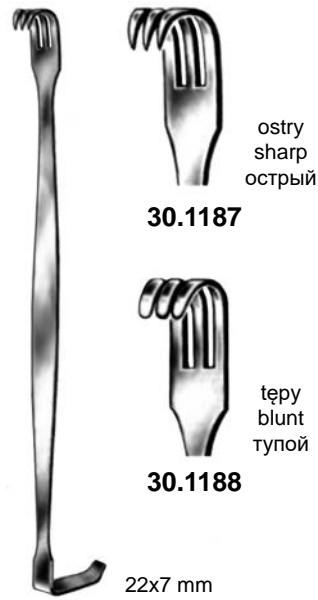

Baby-Senn-Miller
160 mm

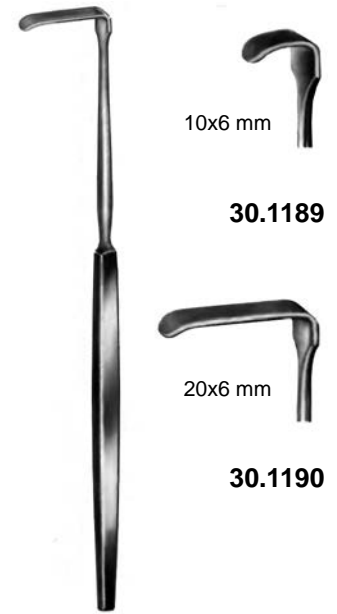

Senn-Green
160 mm



Ragnell-Davis
30.1191
140 mm



Langenbeck-Green
160 mm

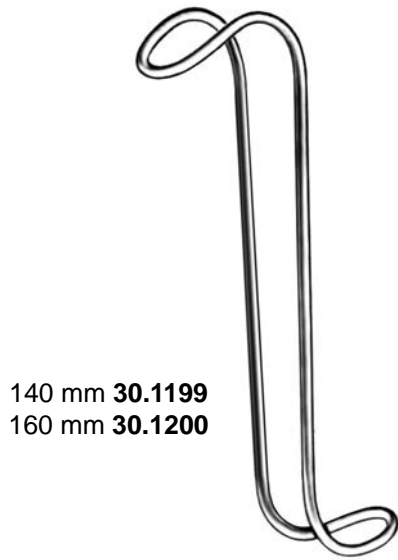

140 mm **30.1199**
160 mm **30.1200**

Collin- Hartmann
Komplet • Set • Набор **30.1198**

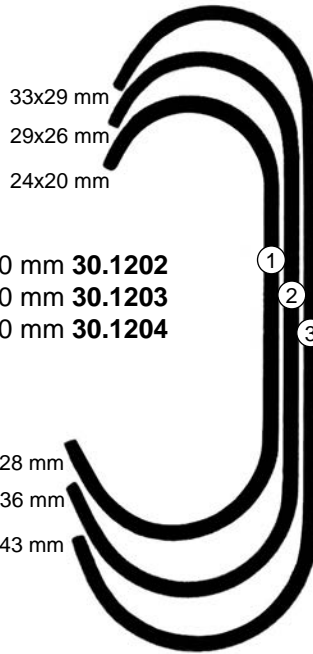

- 1. 140 mm **30.1202**
- 2. 150 mm **30.1203**
- 3. 170 mm **30.1204**

33x29 mm
29x26 mm
24x20 mm

30x28 mm
36x36 mm
38x43 mm



Roux
Komplet • Set • Набор **30.1201**

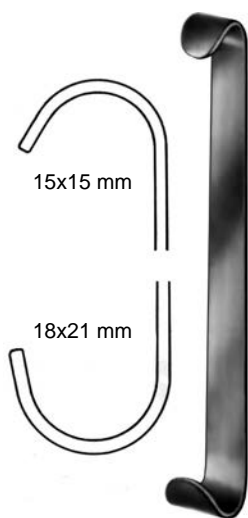

15x15 mm

18x21 mm

Baby-Roux
30.1205
130 mm



Mini-Roux
30.1206
140 mm



37x40 mm

30x31 mm

Goelet
30.1207
190 mm

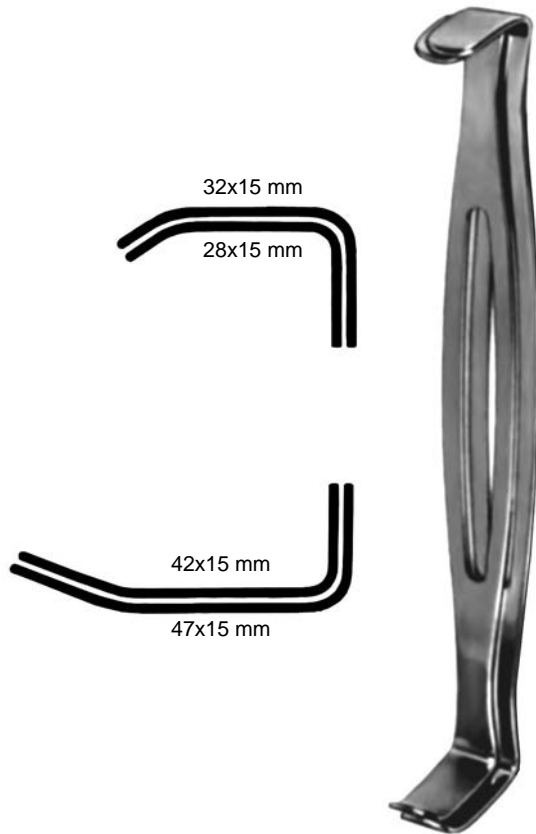

Parker-Langenbeck (US-Army)
30.1208
Komplet • Set • Набор 210 mm

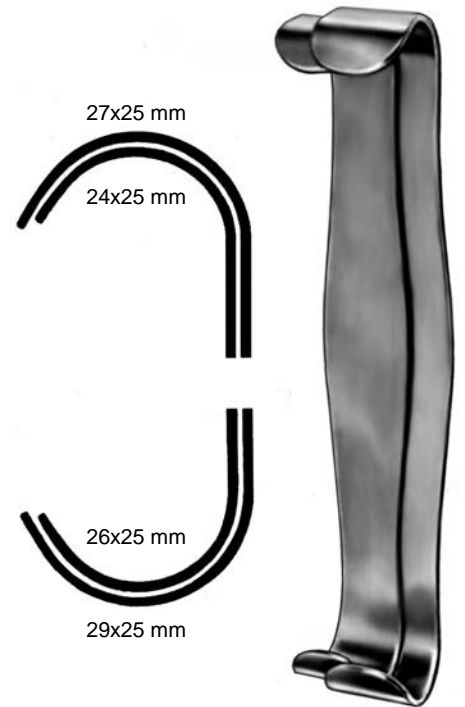

Parker
30.1209
Komplet • Set • Набор 180 mm



Parker
30.1210
Komplet • Set • Набор 135 mm



Parker-Mott
30.1211
Komplet • Set • Набор 160 mm

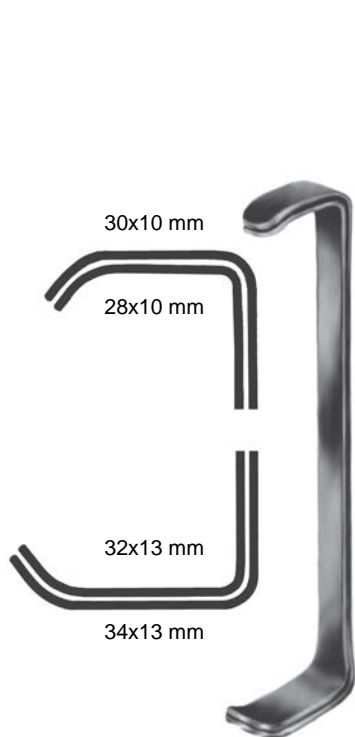

Farabeuf 30.1212
Komplet • Set • Набор
120 mm

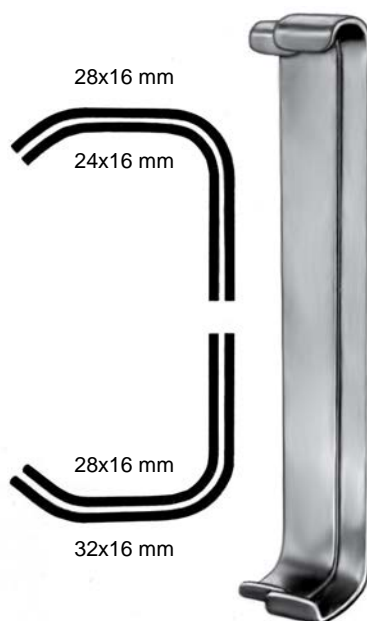

Farabeuf 30.1213
Komplet • Set • Набор
150 mm

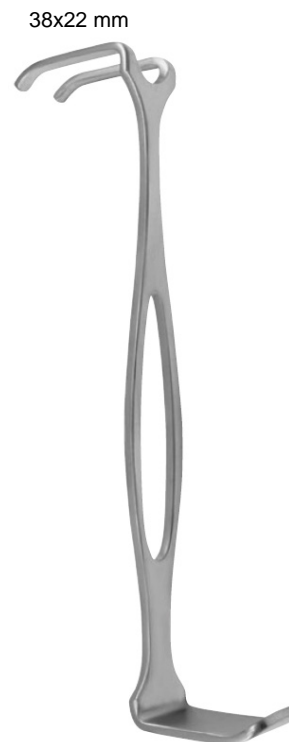

30.1214
175 mm

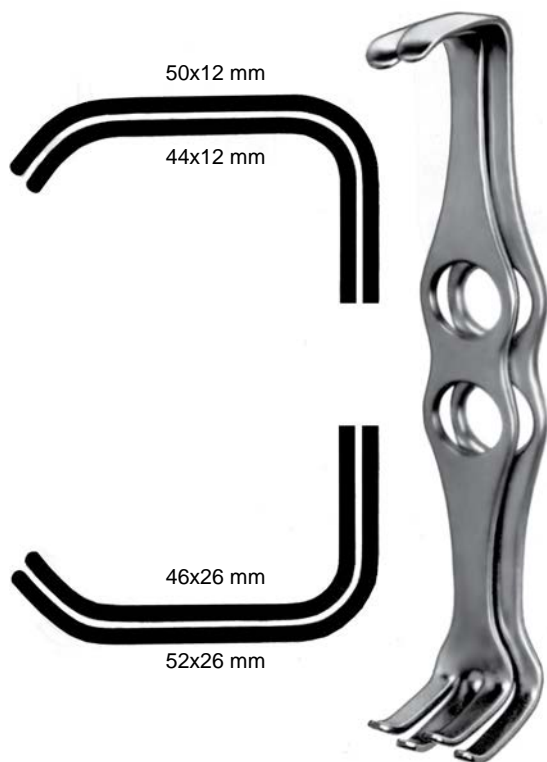

Mathieu 30.1215
Komplet • Set • Набор
200 mm

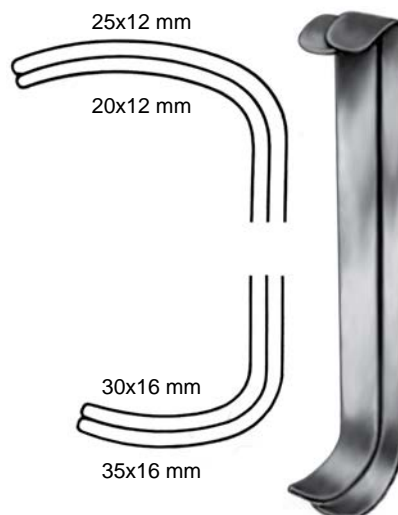

Collin 30.1216
Komplet • Set • Набор
150 mm

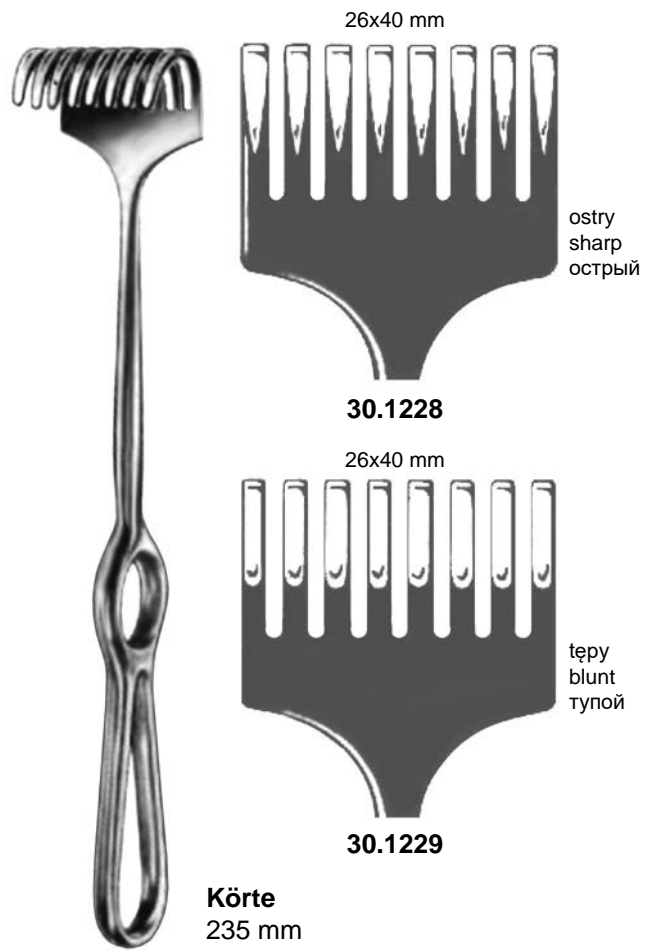
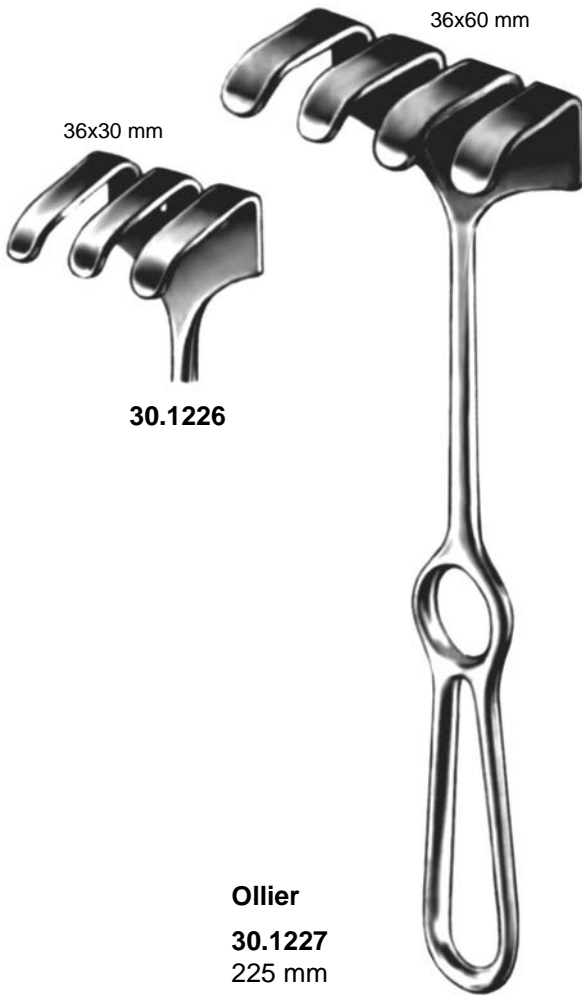

40x40 mm



30.1234

45x50 mm



30.1235

50x60 mm



30.1236

70x70 mm



30.1237

25x40 mm



Israel
250 mm

33x20 mm



Wassmund
30.1238
205 mm

46x55 mm



Körte
30.1239
230 mm



Körte-Wagner
30.1240
280 mm

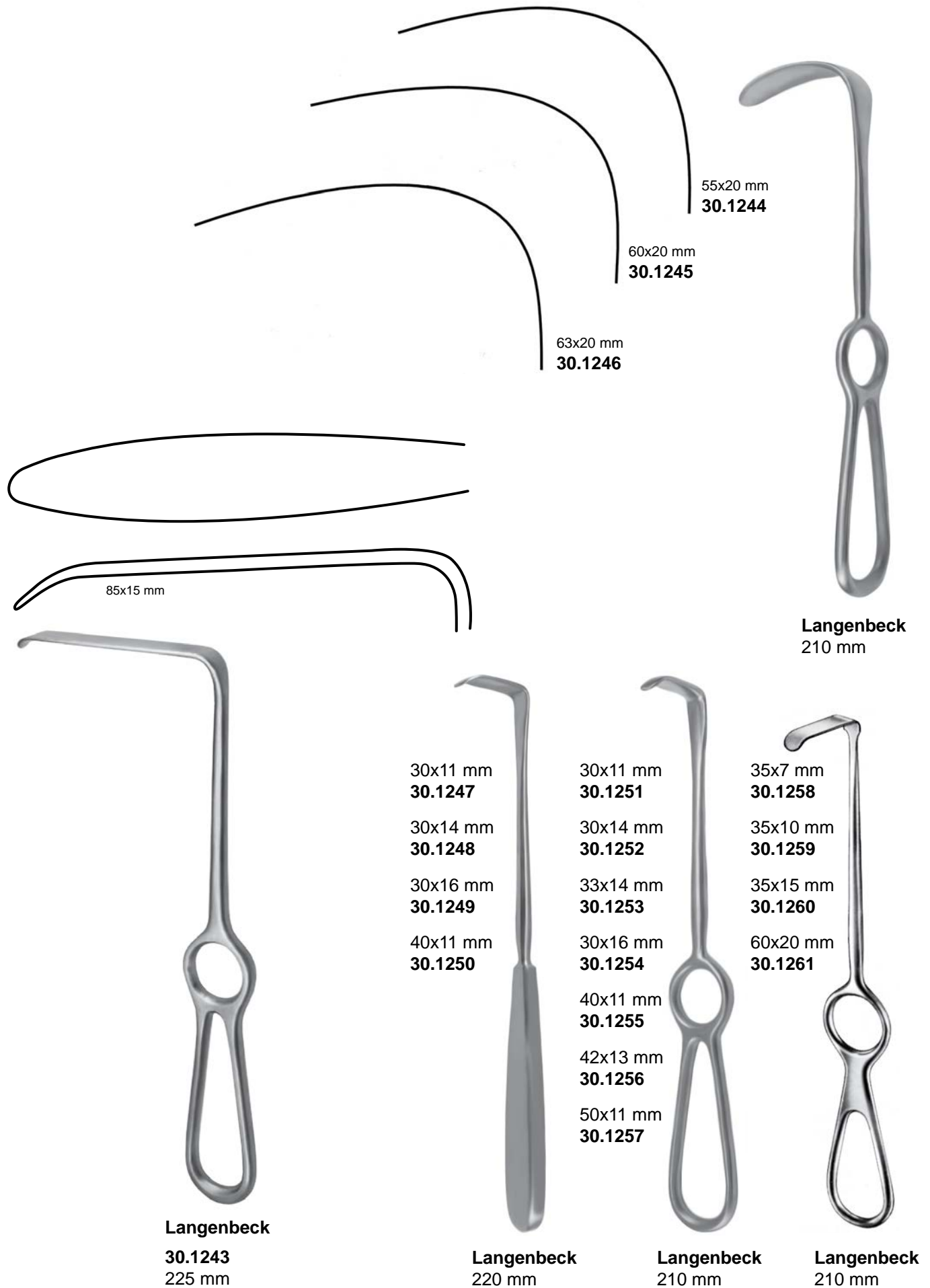

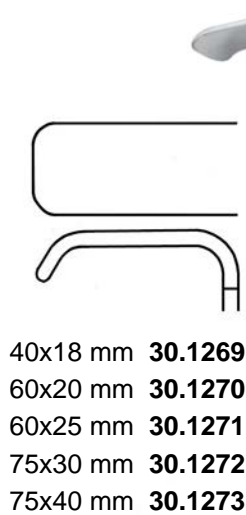
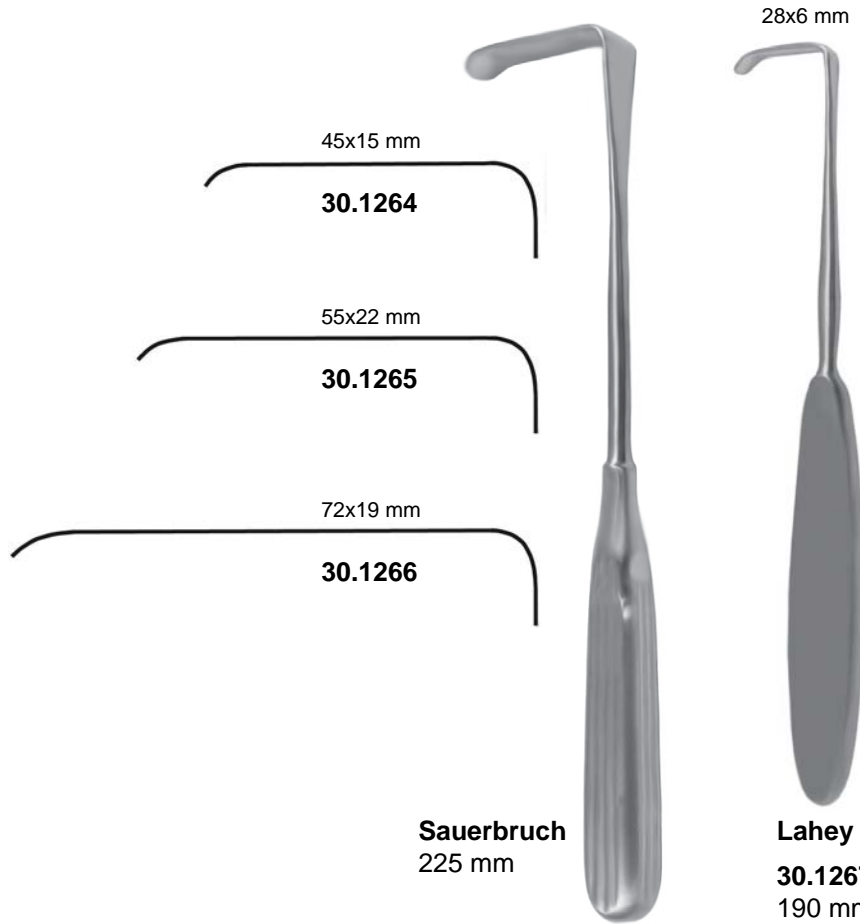
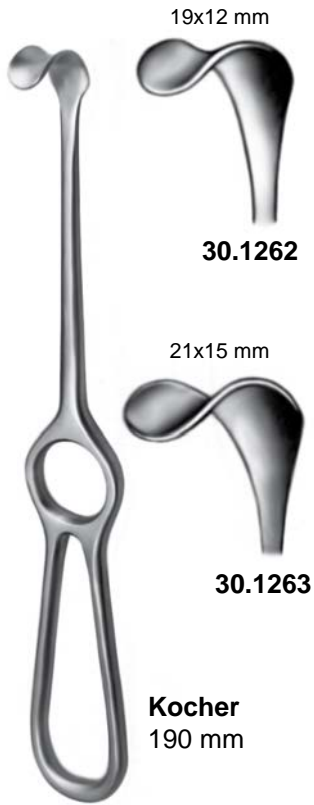

Kocher
215 mm

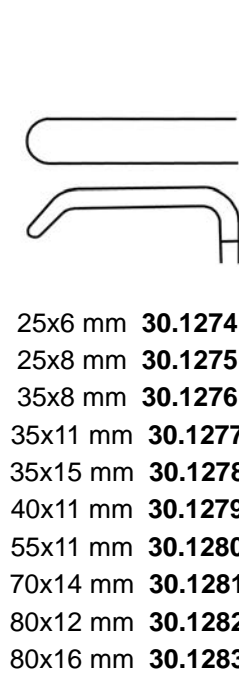

Kocher-Langenbeck
215 mm

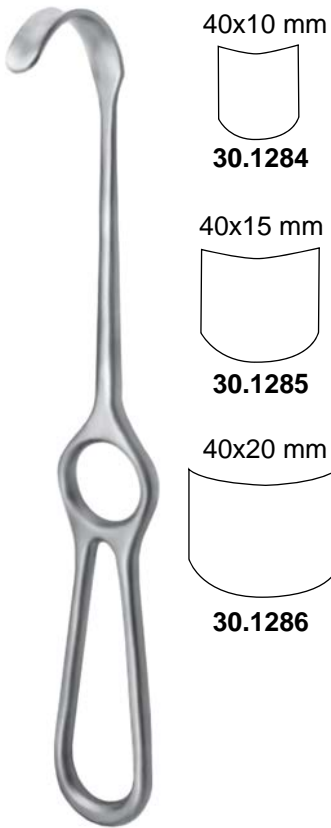

40x10 mm



30.1284

40x15 mm

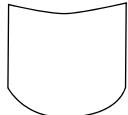

30.1285

40x20 mm

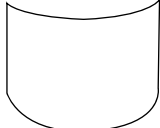

30.1286

Kocher
220 mm

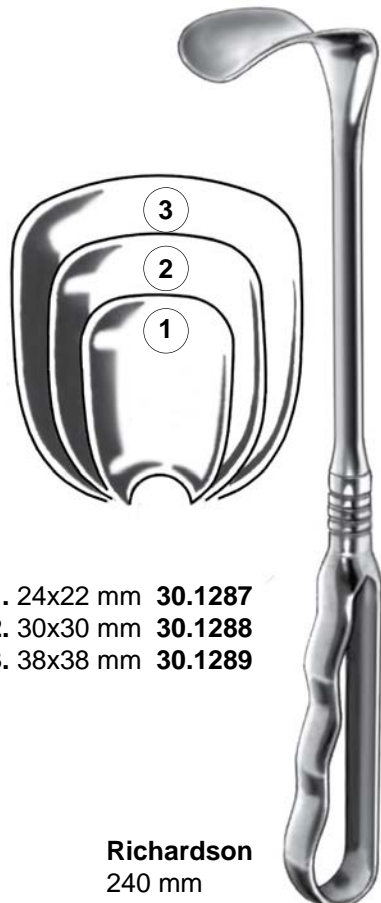

- 1. 24x22 mm **30.1287**
- 2. 30x30 mm **30.1288**
- 3. 38x38 mm **30.1289**

Richardson
240 mm



48x21 mm

Richardson
30.1290
240 mm



65x50 mm

Kelly
30.1291
260 mm

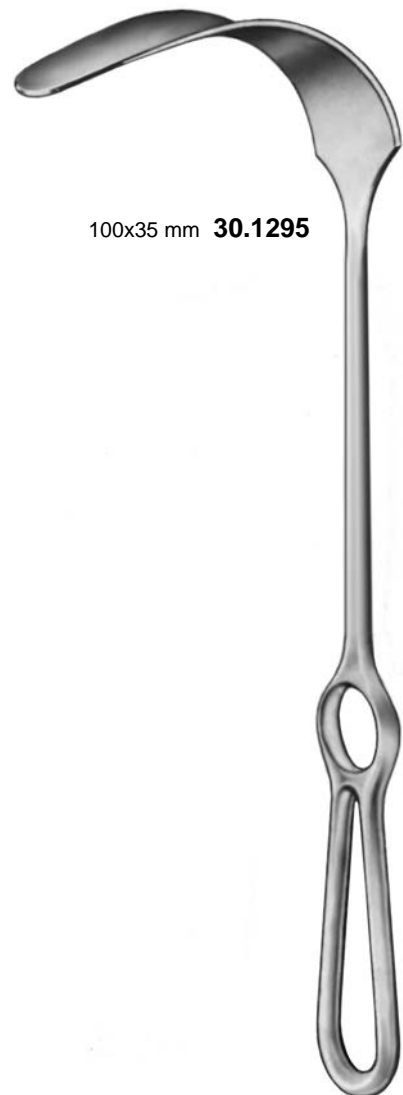
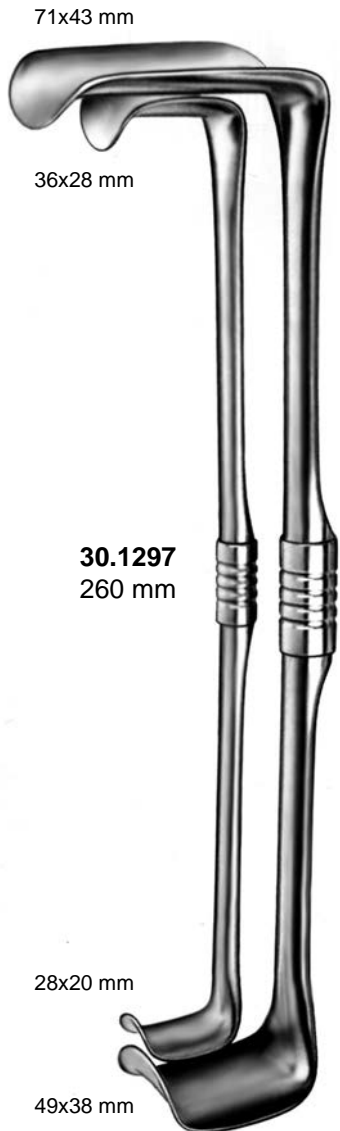

Richardson-Eastman
Komplet • Set • Набор
30.1296

Caspar
30.1299
215 mm



Hösel
250 mm



60x20 mm **30.1300**

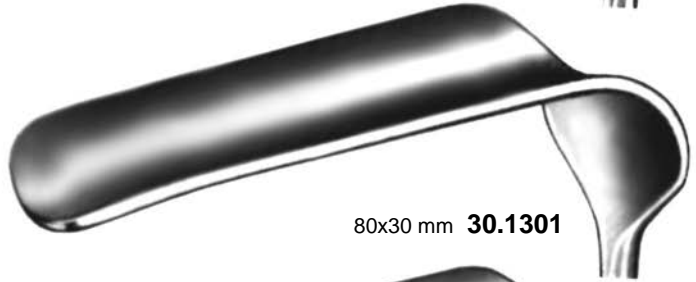

80x30 mm **30.1301**

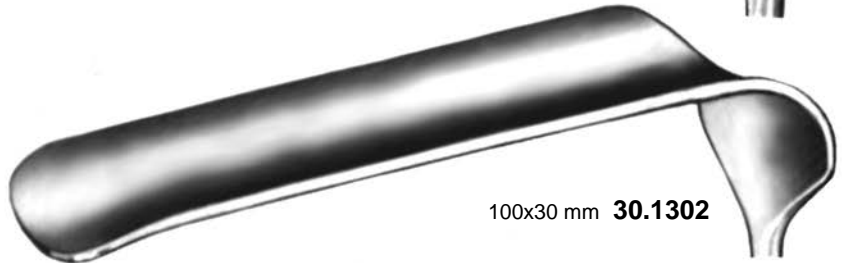

100x30 mm **30.1302**

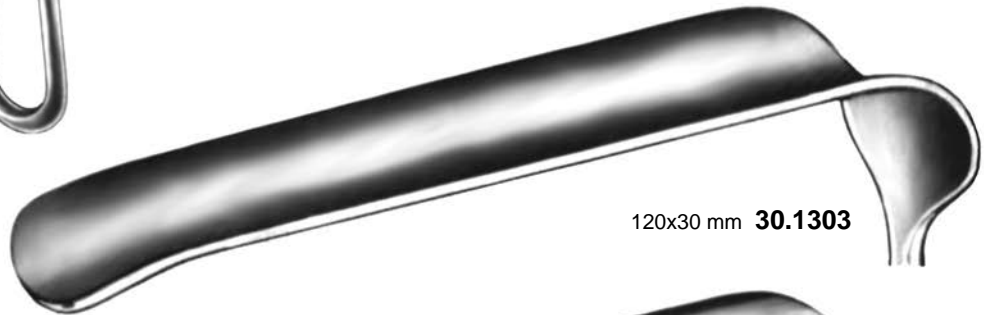

120x30 mm **30.1303**



140x30 mm **30.1304**



140x40 mm **30.1305**



St. Marks

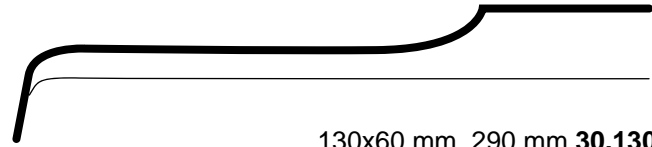

130x60 mm, 290 mm **30.1306**
180x60 mm, 325 mm **30.1307**



180x60 mm, 330 mm **30.1308**

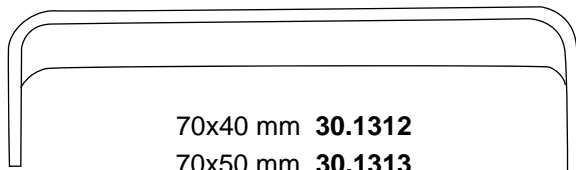

70x40 mm **30.1312**
70x50 mm **30.1313**
70x65 mm **30.1314**

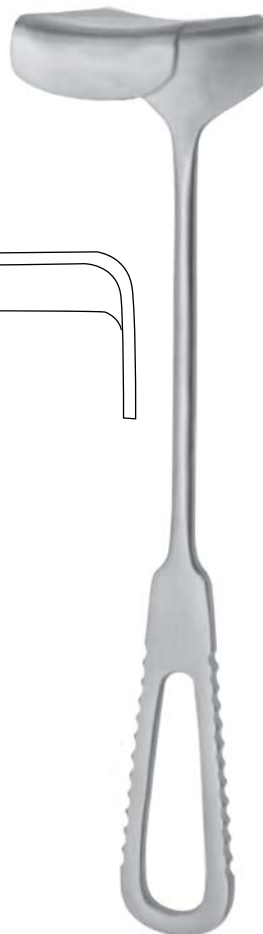

Morris
210 mm



Middelдорpf
275 mm



45x45 mm **30.1315**



45x50 mm **30.1316**



55x70 mm **30.1317**



Middelдорpf



14x17 mm
30.1321
215 mm



20x22 mm
30.1322
220 mm



26x30 mm
30.1323
235 mm

40x5 mm



Blount
30.1324
175 mm

51x19 mm



Richardson
30.1329
235 mm



Richardson
240 mm



25x19 mm
30.1330



32x25 mm
30.1331



38x38 mm
30.1332



64x51 mm
30.1334



76x64 mm
30.1335



89x76 mm
30.1336



51x38 mm
30.1015

Kelly
250 mm

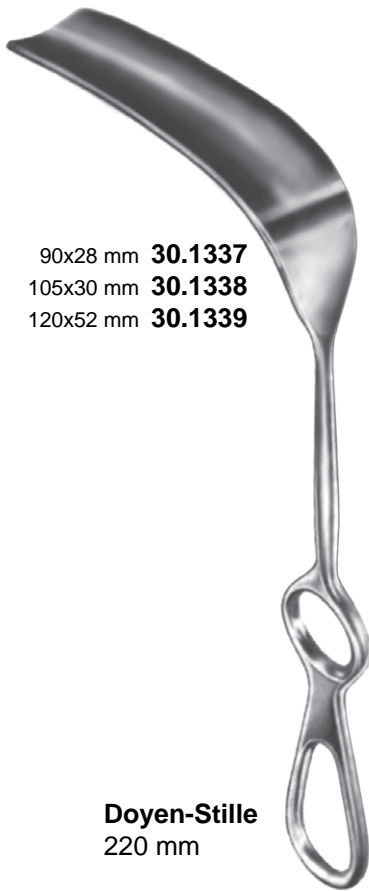

90x28 mm **30.1337**
105x30 mm **30.1338**
120x52 mm **30.1339**

Doyen-Stille
220 mm



40x40 mm **30.1340**
45x50 mm **30.1342**
45x60 mm **30.1343**
45x75 mm **30.1344**
65x85 mm **30.1345**

Fritsch
240 mm



53x80 mm **30.1346**

Doyen
250 mm



64x60 mm **30.1348**

Tuffier
230 mm





95x20 mm

Modell Tübingen

30.1358
265 mm



105x27 mm

Martin

30.1359
250 mm

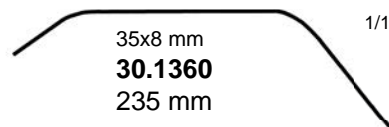

35x8 mm
30.1360
235 mm

1/1

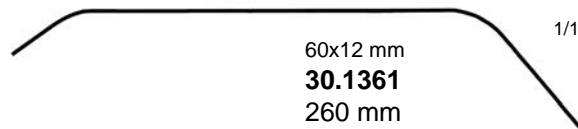

60x12 mm
30.1361
260 mm

1/1

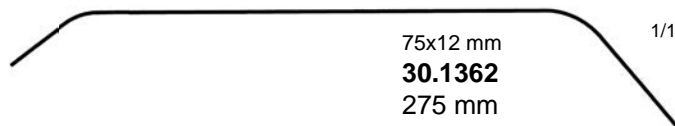

75x12 mm
30.1362
275 mm

1/1

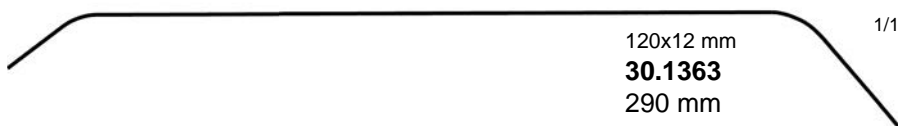

120x12 mm
30.1363
290 mm

1/1



Zenker

180x30 mm **30.1364**

160x30 mm **30.1365**

140x30 mm **30.1366**

130x30 mm **30.1367**

120x25 mm **30.1368**

100x25 mm **30.1369**

80x20 mm **30.1370**



Brunner
250 mm

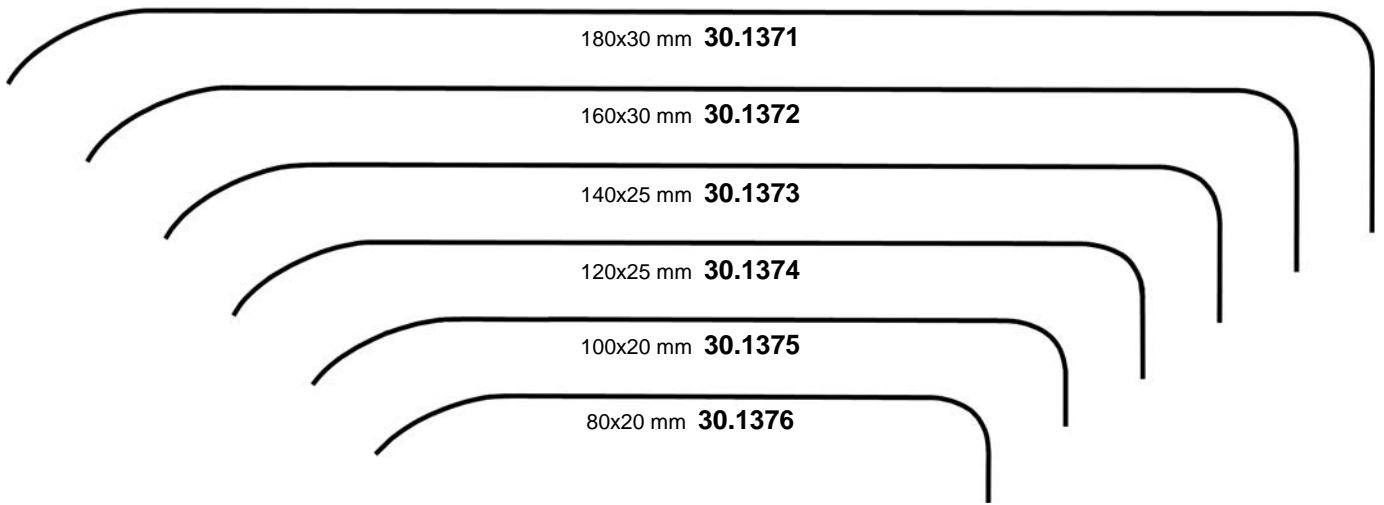

Brunner
250 mm

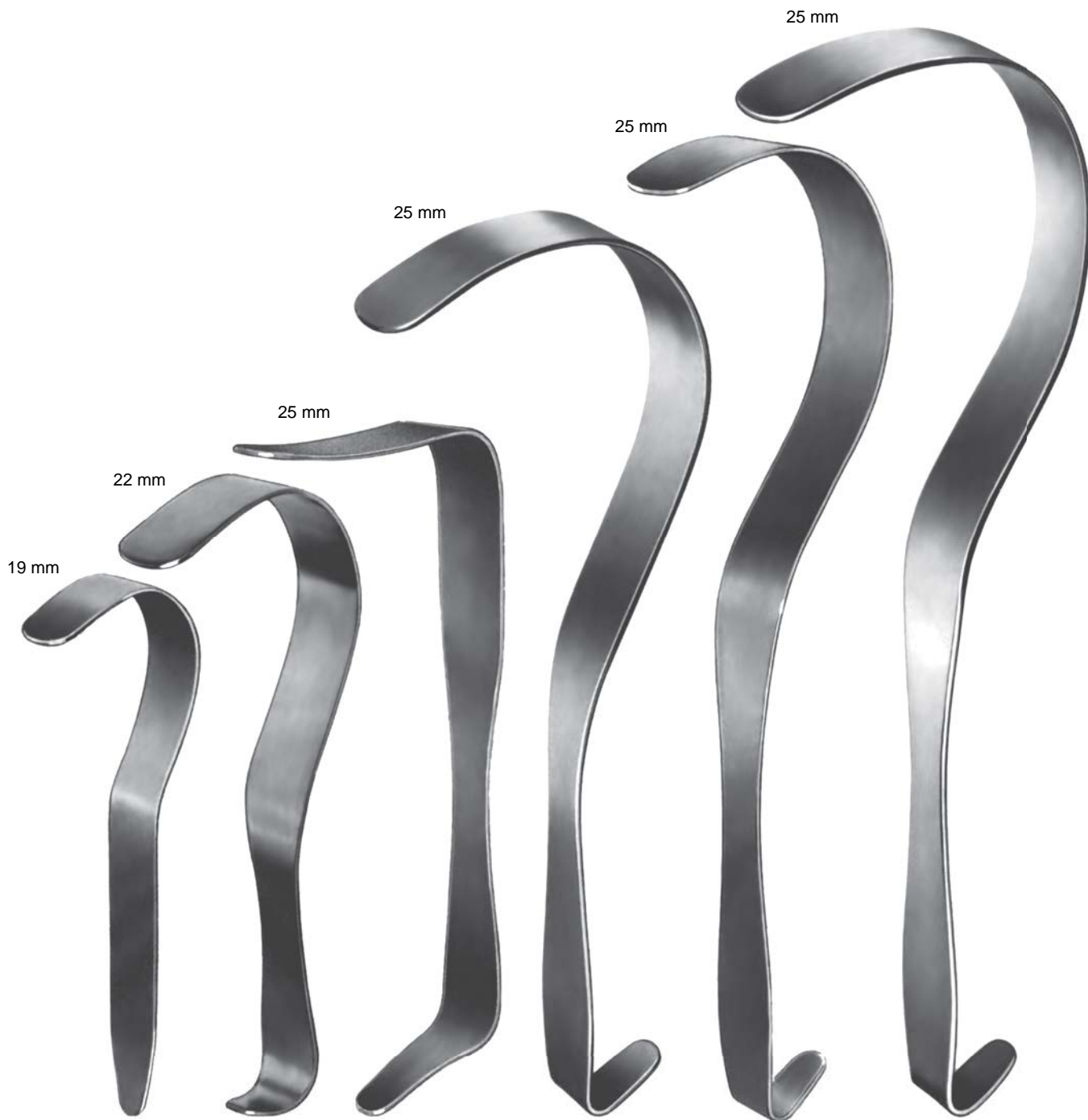

Deaver
30.1377
180 mm

Deaver
30.1378
215 mm

Deaver
30.1379
230 mm

Deaver
30.1380
300 mm

Deaver
30.1381
330 mm

Deaver
30.1382
360 mm

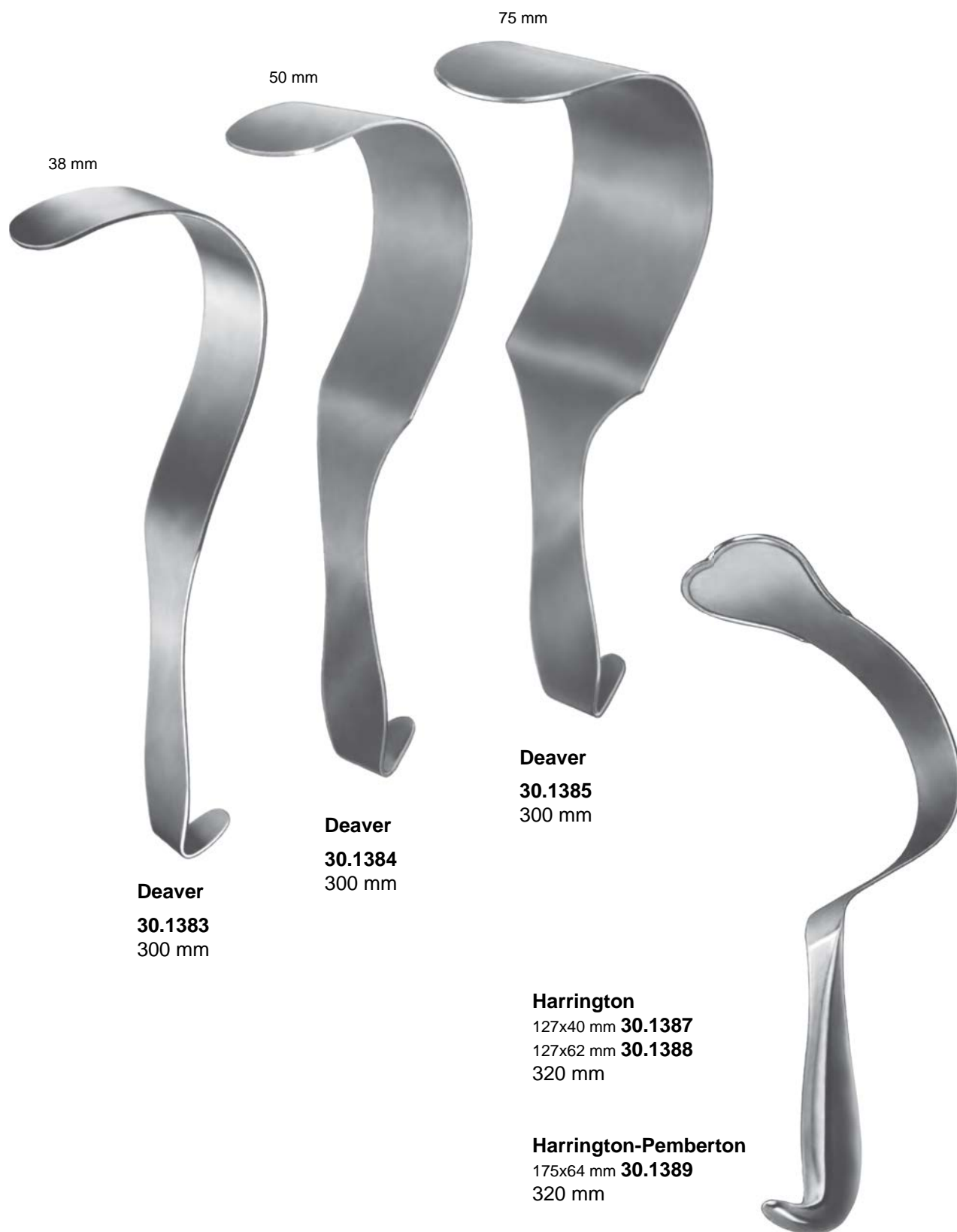



85x35 mm **30.1390**
120x50 mm **30.1391**
155x50 mm **30.1392**



90x50mm **30.1393**



160x38mm **30.1394**
160x57mm **30.1395**
190x38mm **30.1396**
190x57mm **30.1397**

125x37 mm

1/1



1/1

115x65 mm **30.1402**



1/1

115x38 mm **30.1403**



1/1

82x22 mm **30.1404**



Sauerbruch
30.1405
250 mm

Coryllos
240 mm



75x50 mm

Davidson
30.1412
160 mm



Cooley
30.1414
215 mm



75x90 mm

Davidson
30.1413
160 mm

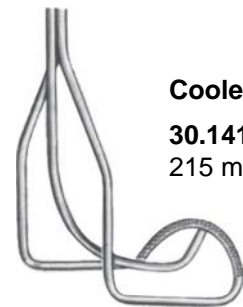

Cooley
30.1415
215 mm

ząbkowany
serrated
зубчатый

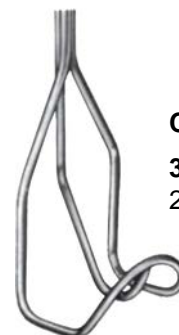

Cooley
30.1416
230 mm

90x50 mm **30.1417**



75x25 mm **30.1418**



50x16 mm **30.1419**



Meyerding
225 mm

elastyczne • flexible • эластичный



330 mm 30 mm **30.1533**
 330 mm 40 mm **30.1534**
 330 mm 50 mm **30.1535**

elastyczne • flexible • эластичный



Tuffier 200 mm 17x25 mm **30.1536**

elastyczne • flexible • эластичный



200 mm	6mm	30.1537	200 mm	17mm	30.1540
200 mm	9mm	30.1538	200 mm	20mm	30.1541
200 mm	12mm	30.1539	200 mm	25mm	30.1542

elastyczne • flexible • эластичный



Haberer 280 mm 25x30 mm **30.1543**
 300 mm 37x45 mm **30.1544**



Reverdin 285 mm 65x45 mm **30.1545**

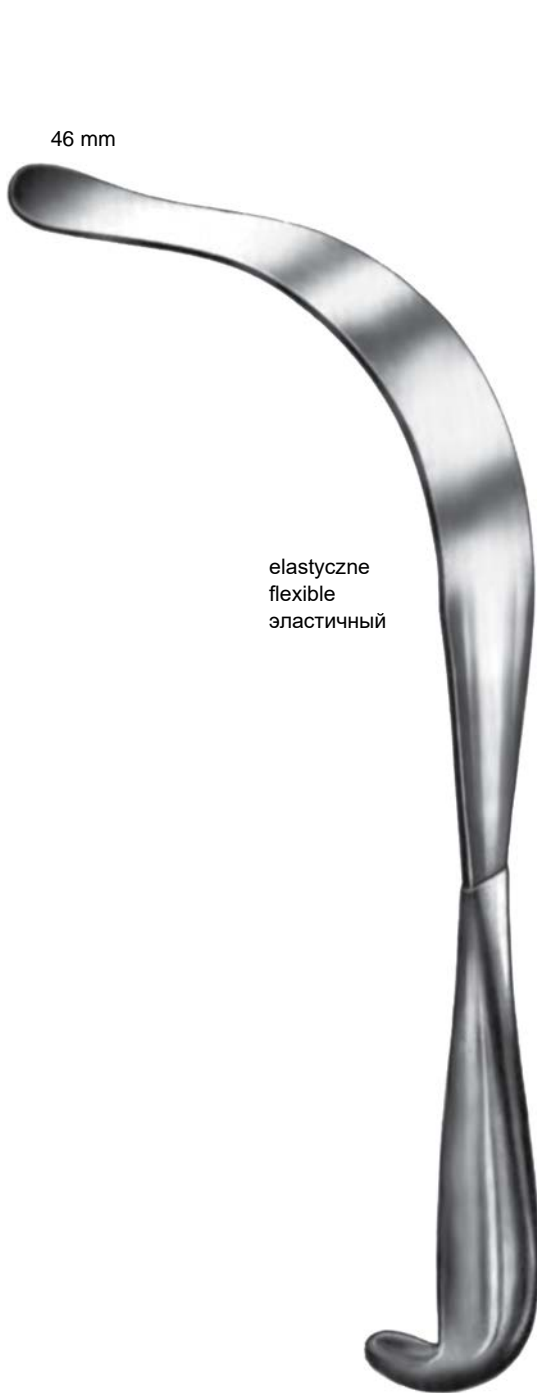

46 mm

elastyczne
 flexible
 эластичный

Kuemmel
30.1592
 330 mm



elastyczne
 flexible
 эластичный

30 mm **30.1593**
 40 mm **30.1438**
 50 mm **30.1439**
 60 mm **30.1440**
 70 mm **30.1441**

410 mm



30.1442
 ostry
 sharp
 острый

30.1443
 tępy
 blunt
 тупой

Finsen
 50 mm



30.1445
 tępy
 blunt
 тупой

Finsen
 70 mm



30.1446
 ostry
 sharp
 острый

30.1447
 tępy
 blunt
 тупой



Alm

ostry sharp острый	tępy blunt тупой
--------------------------	------------------------

70 mm	30.1450	30.1452
100 mm	30.1451	30.1453



30.1454
 ostry
 sharp
 острый

30.1455
 tępy
 blunt
 тупой

Holtzheimer
 100 mm



Jansen
 100 mm

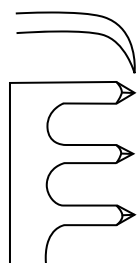

30.1457
 ostry
 sharp
 острый

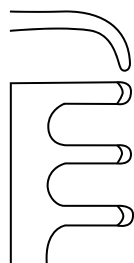

30.1456
 tępy
 blunt
 тупой

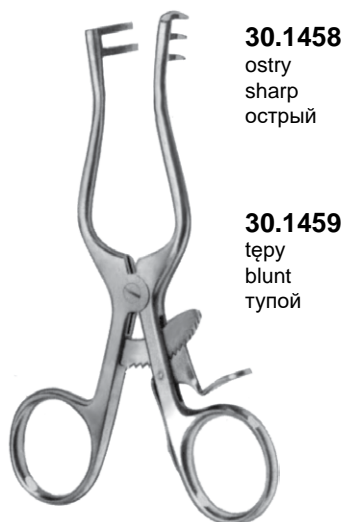

30.1458
 ostry
 sharp
 острый

30.1459
 tępy
 blunt
 тупой

Weitlaner-Loktite
 105 mm



	ostry sharp острый	tępy blunt тупой
130 mm	30.1460	30.1461
165 mm	30.1462	30.1463
200 mm	30.1464	30.1465

Weitlaner-Loktite



30.1466
 ostry
 sharp
 острый

30.1467
 tępy
 blunt
 тупой

Weitlaner-Wullstein
 130 mm



Weitlaner-Baby

30.1468
 130 mm



30.1469
 ostry
 sharp
 острый

30.1470
 tępy
 blunt
 тупой

Scalp Contour
 140mm



Cone

	ostry sharp острый	tępy blunt тупой
130 mm	30.1471	30.1472
165 mm	30.1473	30.1474
200 mm	30.1475	30.1476
250 mm	30.1477	30.1478



tępy
blunt
тупой

Plester
30.1479
 110mm



tępy
blunt
тупой

Plester
30.1548
 110mm

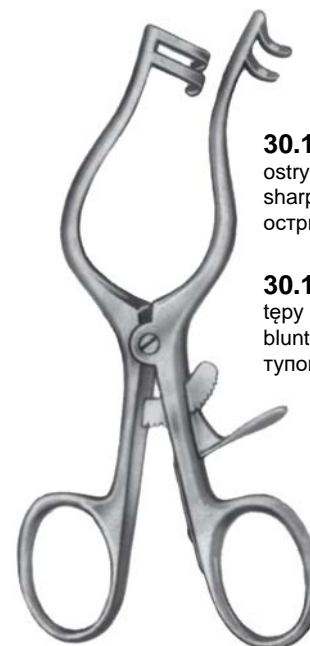

30.1480
 ostry
 sharp
 острый

30.1481
 tępy
 blunt
 тупой

Plester
 130mm



Milligan
130 mm

30.1482.000

tępy
blunt
тупой

30.1482.100

ostry
sharp
острый



Tübinger Modell

30.1483
165 mm



Mollison
30.1484
155 mm



Adson-Baby
160 mm

30.1485

tępy
blunt
тупой

30.1486

ostry
sharp
острый



Beckmann
310 mm

30.1487
ostry
sharp
острый

30.1488
tępy
blunt
тупой

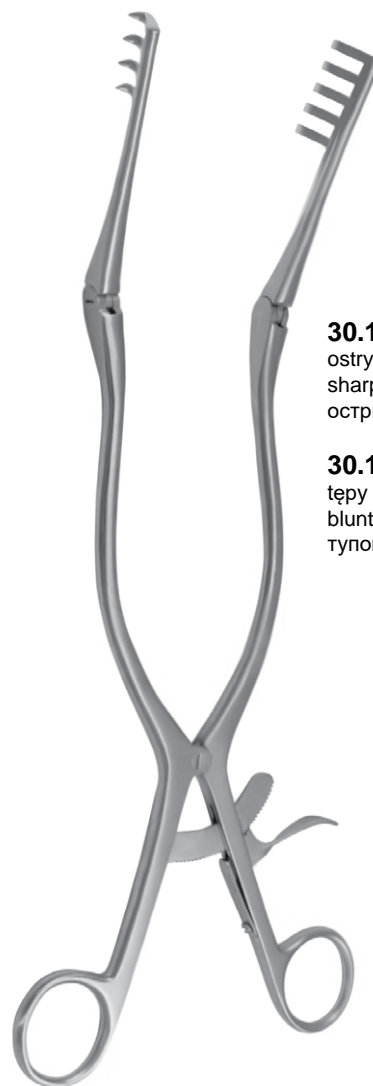

Adson
320 mm

30.1489
ostry
sharp
острый

30.1490
tępy
blunt
тупой



Adson
200 mm

	18 mm	25 mm
ostry sharp острый	30.1491	30.1491.025
tępy blunt тупой	30.1492	30.1492.025

25 mm
 35 mm

Adson
 265 mm

	25 mm	35 mm
ostry sharp острый	30.1493	30.1493.035
tępy blunt тупой	30.1494	30.1494.035

 ramię lewe 35 mm, prawe 18 mm
 left arm 35 mm, right arm 18 mm

30.1495.100

 ramię lewe 18 mm, prawe 35 mm
 left arm 18 mm, right arm 35 mm

30.1495.200

	35 mm
ostry sharp острый	30.1495
tępy blunt тупой	30.1496

35 mm

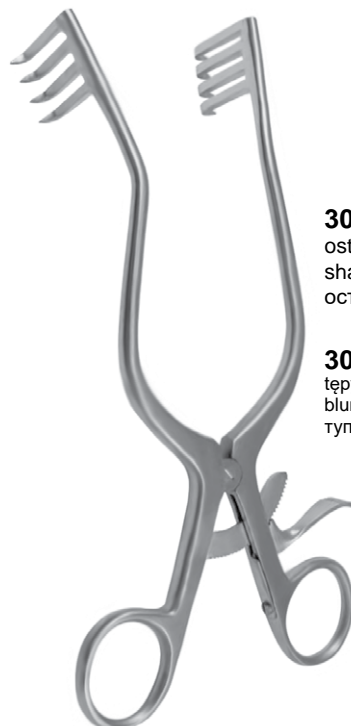
Adson
 265 mm

Anderson-Adson
 195 mm

30.1497.000

 ostry
 sharp
 острый

30.1497.100

 tępy
 blunt
 тупой



44 mm

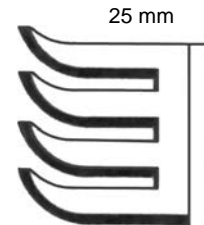

25 mm

30.1499

 ostry
 sharp
 острый

30.1500

 tępy
 blunt
 тупой

30.1501

 ostry
 sharp
 острый

30.1502

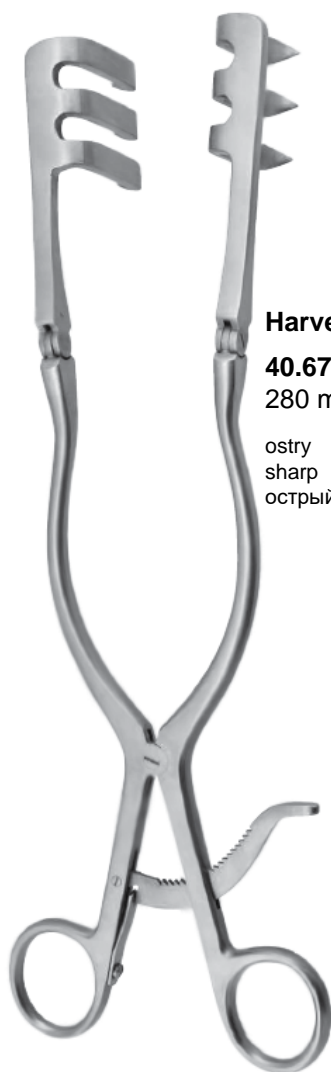
 tępy
 blunt
 тупой

Harvey-Jackson
40.6792
 280 mm

 ostry
 sharp
 острый

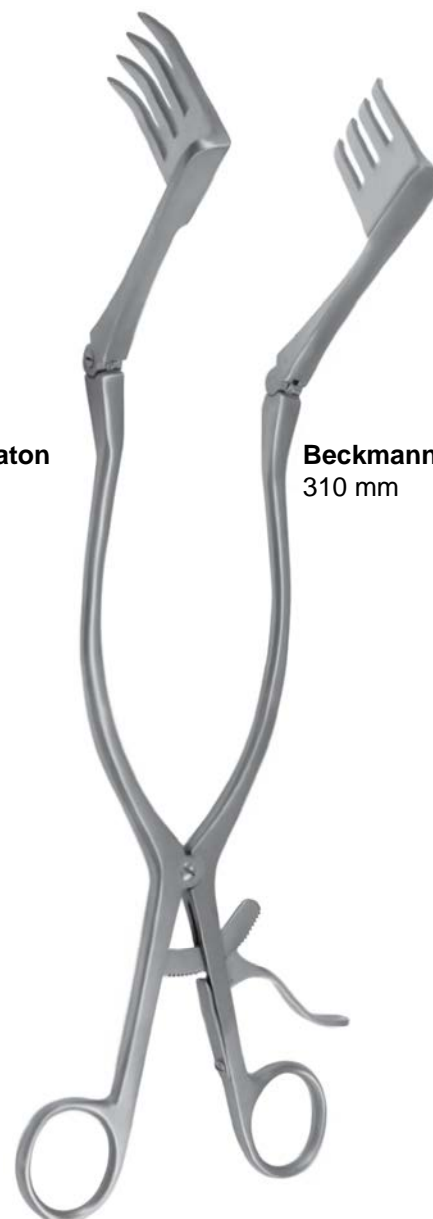
Beckmann-Eaton
30.1498
 320 mm

 ostry
 sharp
 острый

Beckmann-Adson

310 mm



Ricard	Rozchylenie	Łyżki boczne	Łyżka środkowa
	Spread	Lateral blades	Center blade
	Раскрытие	Боковые ложки	Серединная ложка
30.1503	280 mm	72x85 mm	80x90 mm
30.1504	300 mm	60x80 mm	55x70 mm



Holzbach	Łyżki boczne	Łyżka środkowa
	Lateral blades	Center blade
	Боковые ложки	Серединная ложка
30.1507	62x80 mm	80x80 mm

Łyżki wymienne
 Exchangeable blades
 Заменяемые ложки



18x40 mm - **30.1511**
 27x40 mm - **30.1512**
 38x60 mm - **30.1513**
 40x80 mm - **30.1514**
 45x80 mm - **30.1515**
 60x80 mm - **30.1516**



Collin-loktite

260 mm

Rozchylenie	Łyżki boczne	Łyżka środkowa
Spread	Lateral blades	Center blade
Раскрытие	Боковые ложки	Серединная ложка

30.1508

160 mm

60x80 mm

60x75 mm

Collin-loktite

260 mm

Rozchylenie	Łyżki boczne	Łyżka środkowa
Spread	Lateral blades	Center blade
Раскрытие	Боковые ложки	Серединная ложка

30.1509

100 mm

38x60 mm

38x55 mm

30.1510

100 mm

38x80 mm

50x75 mm



Komplet z 2 parami łyżek
 Set with 2 pairs of blades
 Комплект с двумя парами ложек

Baby-Collin	Rozchylenie Spread Раскрытие	Łyżki boczne Lateral blades Боковые ложки
200 mm		
30.1517	80 mm	27x40 mm 18x40 mm



Collin	Rozchylenie Spread Раскрытие	Łyżki boczne Lateral blades Боковые ложки
240 mm		
30.1518	100 mm	38x60 mm



DeBakey

30.1519 100 mm
30.1520 145 mm



Gelpi-Loktite

30.1521 90 mm
30.1522 115 mm



Gelpi-Loktite

30.1523 140 mm
30.1524 180 mm



Gelpi-Loktite

30.1525
180 mm

Rigby
30.1526
 180 mm

 Rozchylenie
 Spread
 Раскрытие
 100 mm

 Łyżki boczne
 Lateral blades
 Боковые ложки
 70x16 mm

Meyerding
 190 mm

 Łyżki boczne
 Lateral blades
 Боковые ложки

30.1527 25x30 mm
30.1528 25x55 mm
30.1529 25x60 mm
30.1530 20x60 mm

Markham-Meyerding
30.1531
 180 mm

 Rozchylenie
 Spread
 Раскрытие
 83 mm

 Łyżka prawa
 Right blade
 Ложка правая
 45x25 mm

Markham-Meyerding
30.1532
 180 mm

 Rozchylenie
 Spread
 Раскрытие
 83 mm

 Łyżka lewa
 Left blade
 Ложка левая
 45x25 mm



Gosset	Rozchylenie	Łyżki boczne
	Spread	Lateral blades
	Раскрытие	Боковые ложки
	30.1550	100 mm



Gosset	Rozchylenie	Łyżki boczne
	Spread	Lateral blades
	Раскрытие	Боковые ложки
	30.1551	100 mm



Gosset	Rozchylenie	Łyżki boczne	Łyżka środkowa
	Spread	Lateral blades	Center blade
	Раскрытие	Боковые ложки	Серединная ложка
	30.1552	160 mm	35x63 mm



Gosset	Rozchylenie	Łyżki boczne
	Spread	Lateral blades
	Раскрытие	Боковые ложки
	30.1553	140 mm

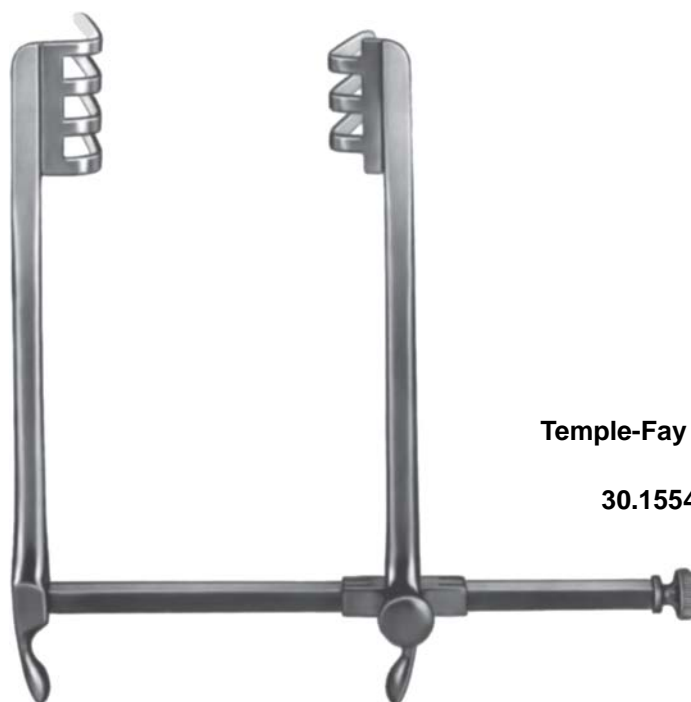

Temple-Fay

Rozchylenie
Spread
Раскрытие

30.1554

120 mm



Frazier

Rozchylenie
Spread
Раскрытие

30.1555

85 mm

Balfour-Baby

	Rozchylenie Spread Раскрытие	Łyżki boczne Lateral blades Боковые ложки	Łyżka środkowa Center blade Серединная ложка
30.1556	90 mm	26x38 mm	25x23 mm

Balfour

	Rozchylenie Spread Раскрытие	Łyżki boczne Lateral blades Боковые ложки	Łyżka środkowa Center blade Серединная ложка
30.1557	180 mm	35x70 mm	45x80 mm

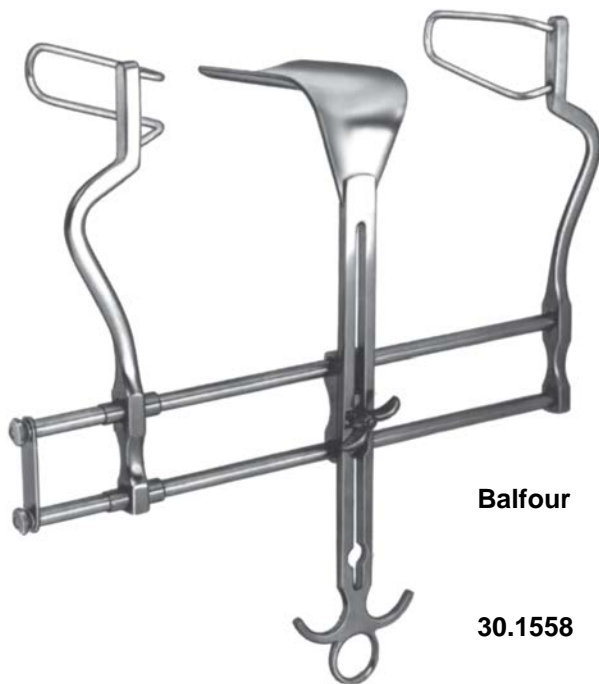
Balfour

	Rozchylenie Spread Раскрытие	Łyżki boczne Lateral blades Боковые ложки	Łyżka środkowa Center blade Серединная ложка
30.1558	200 mm	35x100 mm	60x100 mm

Balfour
30.1559

 Rozchylenie
 Spread
 Раскрытие

250 mm

 Łyżki boczne
 Lateral blades
 Боковые ложки

35x100 mm

 Łyżka środkowa
 Center blade
 Серединная ложка

70x85 mm

Balfour
30.1561
30.1562

 Łyżka środkowa
 Center blade
 Серединная ложка

45x80 mm

70x85 mm

Balfour
30.1560

 Rozchylenie
 Spread
 Раскрытие

180 mm

 Łyżki boczne
 Lateral blades
 Боковые ложки

35x70 mm

 Łyżka środkowa
 Center blade
 Серединная ложка

45x80 mm



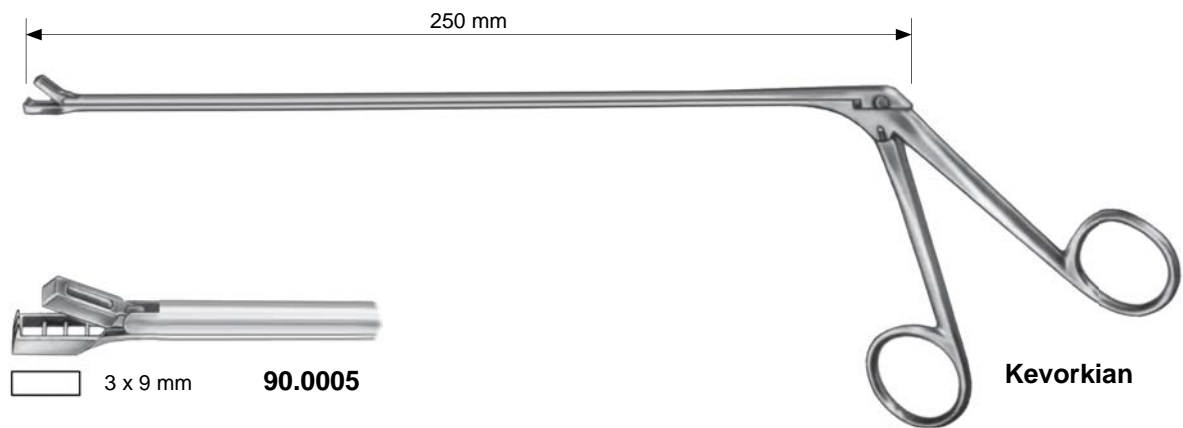
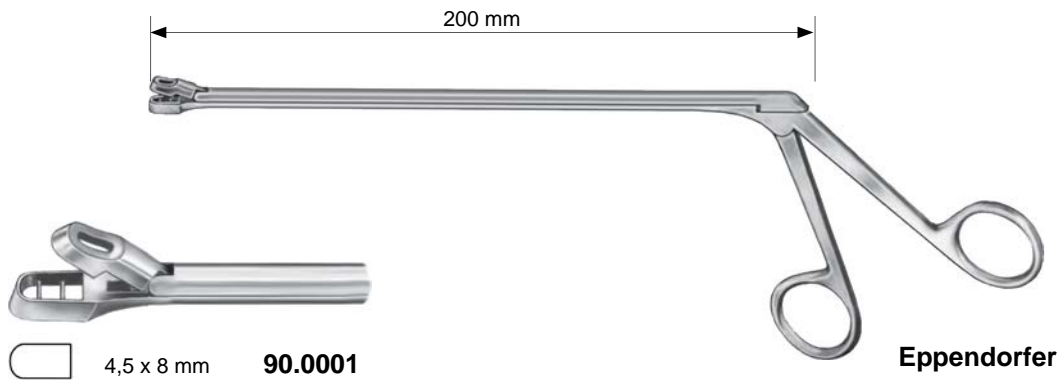

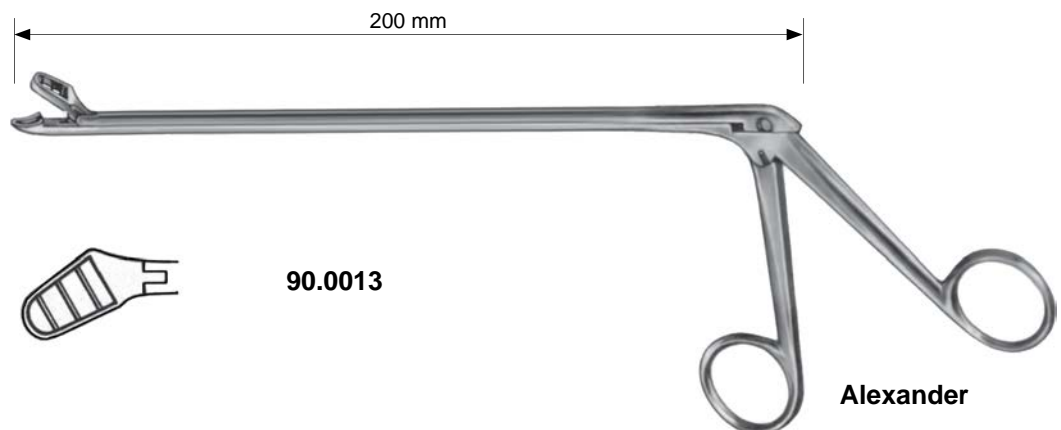
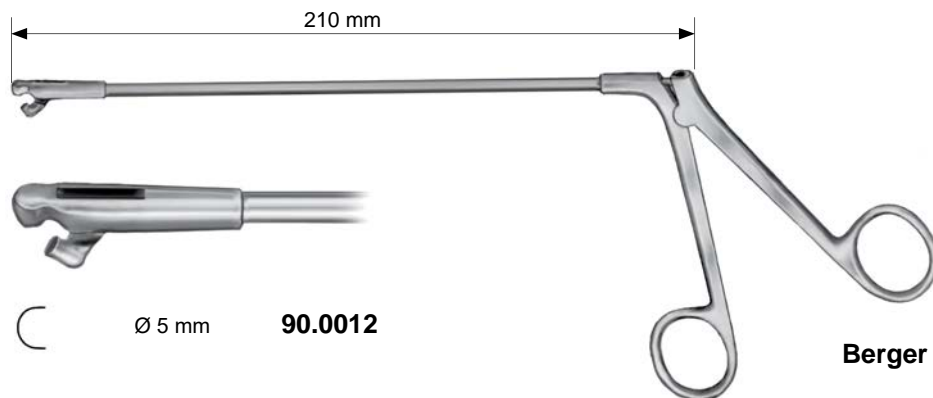
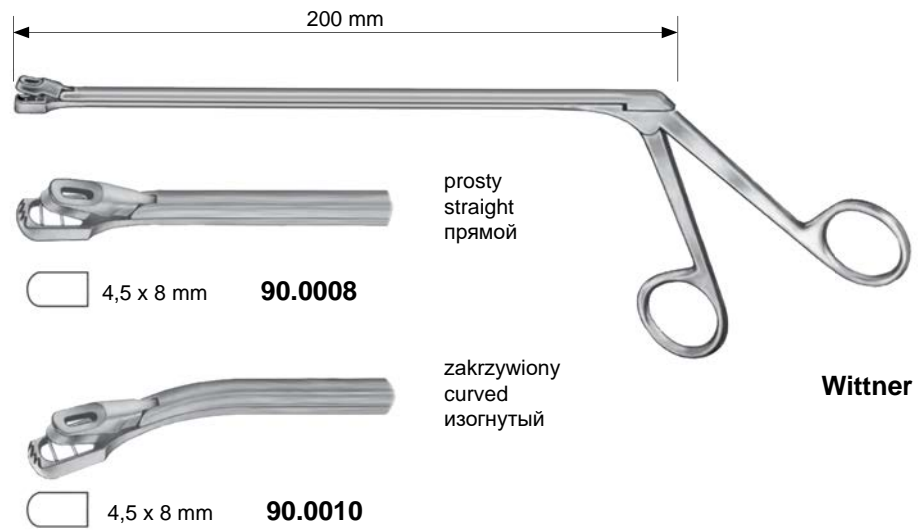

4 mm **90.0015**

6 mm **90.0016**

Schumacher
280 mm

Tischler
90.0014
270 mm

1/1

Schubert
90.0019
260 mm

Schubert
90.0020
210 mm
90.0021
290 mm



90.0022
240 mm

Van Doren



90.0023



Faure
230 mm
90.0026



Thoms-Gaylor
240 mm
90.0027



Gellhorn
230 mm
90.0028

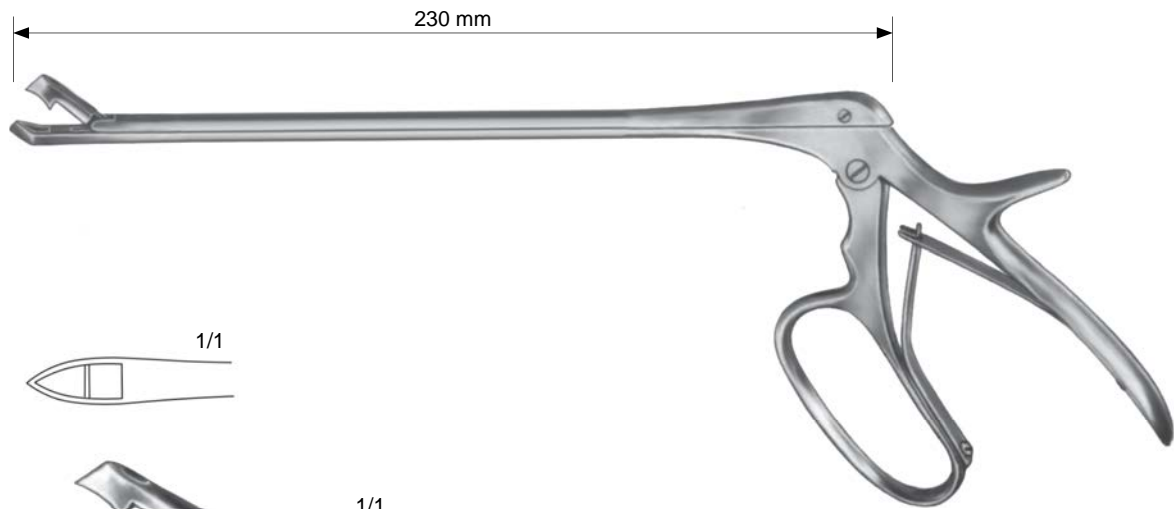

1/1
Tischler
90.0030



1/1
Tischler-Kevorkian
90.0031



1/1
Tischler-Morgan
90.0032

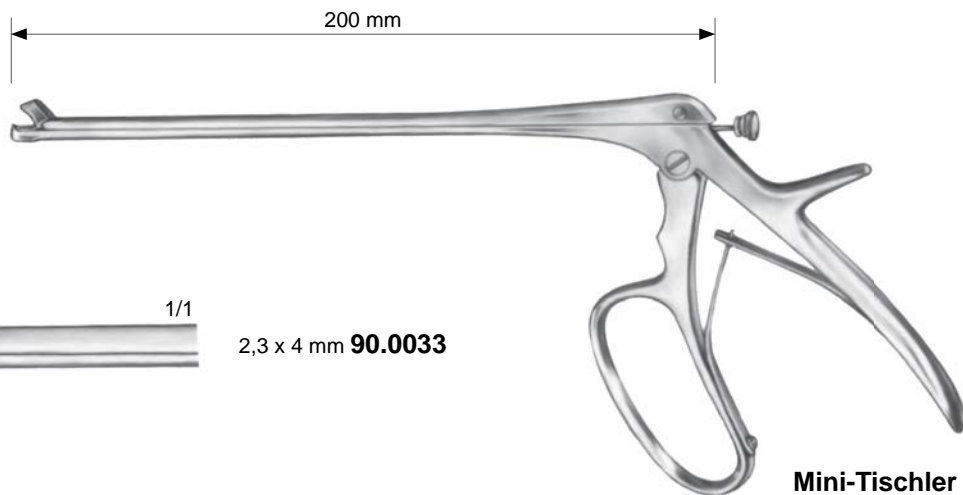

1/1
2,3 x 4 mm 90.0033

Mini-Tischler

Kristeller

wziernik • specula • зеркало

90.0100 70x27 mm

90.0101 80x30 mm

90.0102 90x36 mm

hak • retractor • хак

90.0103 75x23 mm

90.0104 85x26 mm

90.0105 100x32 mm

komplet • set • комплект

90.0106 Fig. 1

90.0107 Fig. 2

90.0108 Fig. 3

krótki model

short model

короткий вариант



Kristeller

wziernik • specula • зеркало

90.0109 105x18 mm

90.0110 105x21 mm

hak • retractor • хак

90.0111 110x14 mm

90.0112 110x17 mm

komplet • set • комплект

90.0113 Fig. 00

90.0114 Fig. 0

stożkowy kształt łyżki i haka
with conically shaped blades
с конической формой лезвий



Kristeller

wziernik • specula • зеркало

90.0117.001 105x26 mm

90.0118.001 105x28 mm

90.0119.001 105x33 mm

hak • retractor • хак

90.0117.002 115x22 mm

90.0118.002 115x24 mm

90.0119.002 115x29 mm

komplet • set • комплект

90.0117.000 Fig. 1

90.0118.000 Fig. 2

90.0119.000 Fig. 3

długi model

long model

длинный вариант

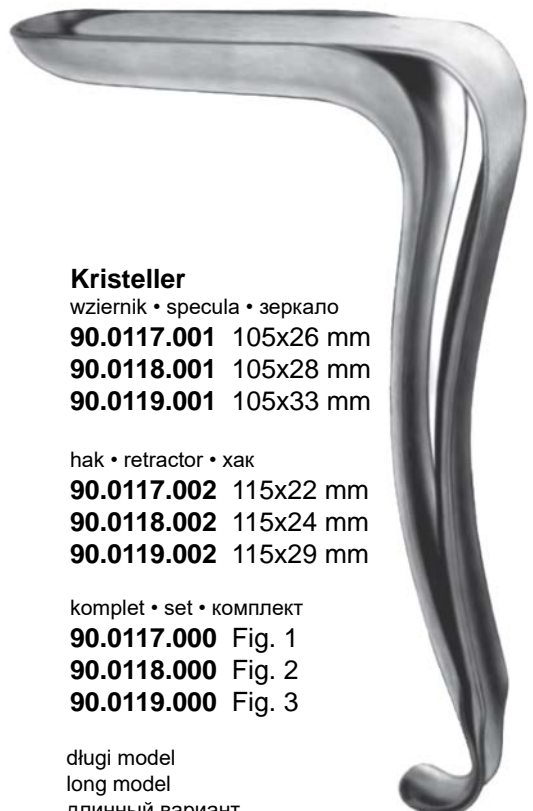

Kristeller

komplet • set • комплект

90.0122 70x15 mm

dla dzieci
for children
для детей



Kallmorgen

komplet • set • комплект

90.0123 70x40 mm

90.0124 90x40 mm

wziernik • specula • зеркало

90.0125 70x40 mm

90.0126 90x40 mm

hak • retractor • хак

90.0127 70x33 mm

90.0128 90x33 mm





podwójny
double
двойной

Sims

90.0129 25x30 mm

90.0130 30x35 mm

90.0131 35x40 mm



Semm

90.0132 95x14/18 mm

90.0133 100x20/25 mm

90.0134 105x27/35 mm



Doyen 70x30 mm

90.0135

240 mm



Breisky

290 mm

90.0136 100x20 mm

90.0137 100x25 mm

90.0138 100x30 mm

90.0139 100x35 mm

90.0140 100x40 mm

320 mm

90.0141 130x20 mm

90.0142 130x25 mm

90.0143 130x30 mm

90.0144 130x35 mm

90.0145 130x40 mm

350 mm

90.0146 155x40 mm



lekko wklęsły
slightly concave
слегка вогнутый

Doyen

90.0147 60x35 mm
90.0148 90x35 mm
90.0149 120x35 mm
90.0150 160x35 mm

90.0151 60x45 mm
90.0152 90x45 mm
90.0153 120x45 mm
90.0154 160x45 mm

90.0155 60x60 mm
90.0156 90x60 mm
90.0157 120x60 mm
90.0158 160x60 mm



Collin

90.0171 90x29 mm
90.0172 95x35 mm
90.0173 110x40 mm

haki poprzeczne • lateral retractors • хаки боковые



Lateral Retraktor
2x45° zakrzywiony
2x45° curved
2x45° изогнутый

90.0196
90.0197*)



Lateral Retraktor
2x45° zakrzywiony
2x45° curved
2x45° изогнутый

90.0198
90.0199*)

*) izolowane- stosowane w lasero- i elektrochirurgii • used in Laser- and Electrosurgery • использованные в лазер- и электрохирургии



Kogan
280 mm
z zapadką
with ratchet
с замком



4 x 23 mm
90.0200
90.0201*)

6 x 23 mm
90.0202
90.0203*)



3 x 23 mm
90.0204
90.0205*)



Kogan
90.0206
240 mm
bez zapadki
without ratchet
без замка



6 x 23 mm



Kogan
90.0207
240 mm
z zapadką śrubową
with screw ratchet
с винтовым замком

*) izolowane- stosowane w lasero- i elektrochirurgii • used in Laser- and Electrosurgery • использованные в лазер- и электрохирургии

Hegar

90.0229 1 mm	90.0259 1,5 mm
90.0230 2 mm	90.0260 2,5 mm
90.0231 3 mm	90.0261 3,5 mm
90.0232 4 mm	90.0262 4,5 mm
90.0233 5 mm	90.0263 5,5 mm
90.0234 6 mm	90.0264 6,5 mm
90.0235 7 mm	90.0265 7,5 mm
90.0236 8 mm	90.0266 8,5 mm
90.0237 9 mm	90.0267 9,5 mm
90.0238 10 mm	90.0268 10,5 mm
90.0239 11 mm	90.0269 11,5 mm
90.0240 12 mm	90.0270 12,5 mm
90.0241 13 mm	90.0271 13,5 mm
90.0242 14 mm	90.0272 14,5 mm
90.0243 15 mm	90.0273 15,5 mm
90.0244 16 mm	90.0274 16,5 mm
90.0245 17 mm	90.0275 17,5 mm
90.0246 18 mm	90.0276 18,5 mm
90.0247 19 mm	90.0277 19,5 mm
90.0248 20 mm	90.0278 20,5 mm
90.0249 21 mm	90.0279 21,5 mm
90.0250 22 mm	90.0280 22,5 mm
90.0251 23 mm	90.0281 23,5 mm
90.0252 24 mm	
90.0253 25 mm	
90.0254 26 mm	
90.0255 27 mm	
90.0256 28 mm	
90.0257 29 mm	
90.0258 30 mm	

komplet • set • набор

90.0282 4-17 mm

14 sztuk w komplecie • pieces per set • частей в наборе

90.0283 1-26 mm

26 sztuk w komplecie • pieces per set • частей в наборе

Hegar

podwójny • double • двойной

90.0294	1/2 mm
90.0295	3/4 mm
90.0296	5/6 mm
90.0297	7/8 mm
90.0298	9/10 mm
90.0299	11/12 mm
90.0300	13/14 mm
90.0301	15/16 mm
90.0302	17/18 mm
90.0303	19/20 mm
90.0304	21/22 mm
90.0305	23/24 mm
90.0306	25/26 mm



Sims 320 mm

90.0316

sztywna, z podziałką w cm
rigid, graduated in cm
твердый, степенный в см

90.0317

giętka, z podziałką w cm
malleable, graduated in cm
пружинчатый, степенный в см



Martin 320 mm

90.0318

giętka, z podziałką w cm
malleable, graduated in cm
пружинчатый, степенный в см

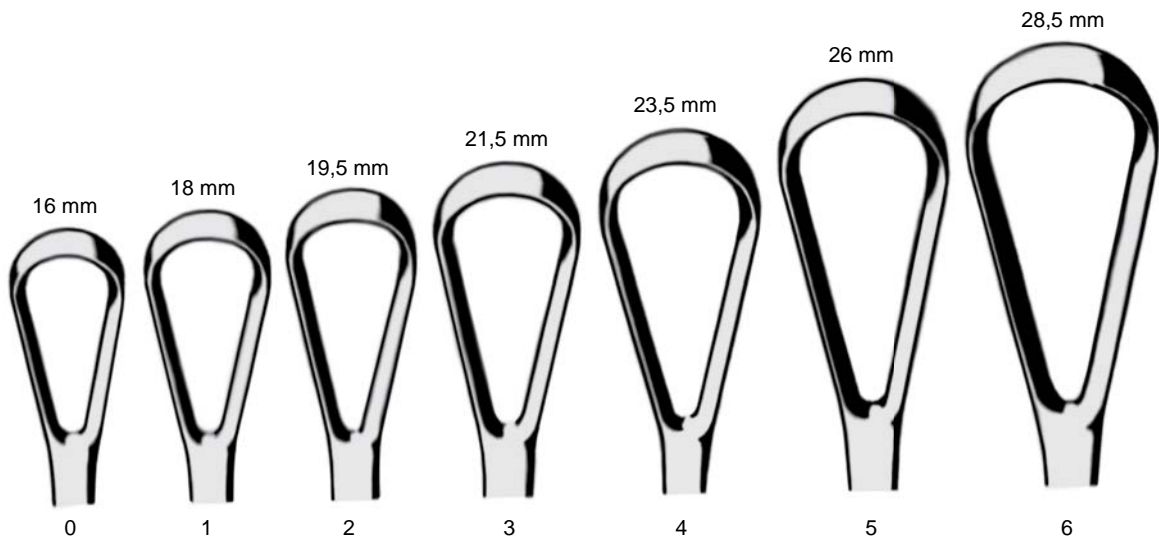

Bumm 280 mm

	ostra, giętka sharp, malleable острая, пружинчатая	tępa, giętka blunt, malleable тупая, пружинчатая
Fig. 0	90.0334	90.0341
Fig. 1	90.0335	90.0342
Fig. 2	90.0336	90.0343
Fig. 3	90.0337	90.0344
Fig. 4	90.0338	90.0345
Fig. 5	90.0339	90.0346
Fig. 6	90.0340	-



Sims 250 mm

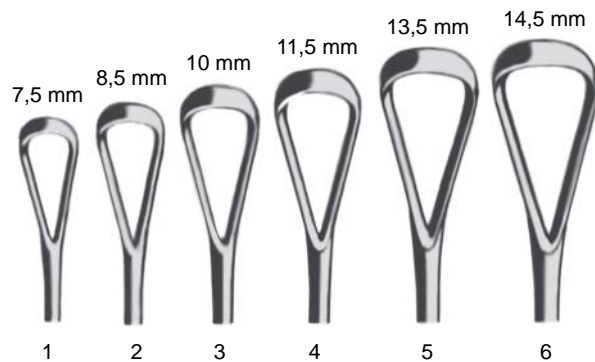

	ostra, giętka sharp, malleable острая, пружинчатая	ostra, sztywna sharp, rigid острая, жёсткая	tępa, giętka blunt, malleable тупая, пружинчатая	tępa, sztywna blunt, rigid тупая, жёсткая
Fig. 1	90.0348	90.0354	90.0360	90.0366
Fig. 2	90.0349	90.0355	90.0361	90.0367
Fig. 3	90.0350	90.0356	90.0362	90.0368
Fig. 4	90.0351	90.0357	90.0363	90.0369
Fig. 5	90.0352	90.0358	90.0364	90.0370
Fig. 6	90.0353	90.0359	90.0365	90.0371

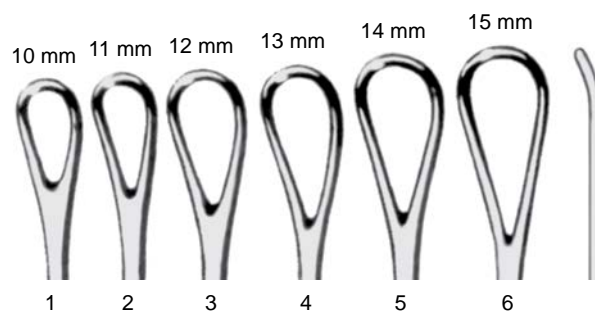

Thomas 280 mm

	tępa, giętka, gładka blunt, malleable, smooth тупая, пружинчатая, гладкая
Fig. 1	90.0372
Fig. 2	90.0373
Fig. 3	90.0374
Fig. 4	90.0375
Fig. 5	90.0376
Fig. 6	90.0377





		ostra, giętka sharp, malleable острая, пружинчатая	ostra, sztywna sharp, rigid острая, жёсткая	tępa, giętka blunt, malleable тупая, пружинчатая	tępa, sztywna blunt, rigid тупая, жёсткая
Fig. 00	5 mm	90.0378	90.0396	90.0414	90.0432
Fig. 0	6 mm	90.0379	90.0397	90.0415	90.0433
Fig. 1	7 mm	90.0380	90.0398	90.0416	90.0434
Fig. 2	8 mm	90.0381	90.0399	90.0417	90.0435
Fig. 3	9 mm	90.0382	90.0400	90.0418	90.0436
Fig. 4	11 mm	90.0383	90.0401	90.0419	90.0437
Fig. 5	12 mm	90.0384	90.0402	90.0420	90.0438
Fig. 6	14 mm	90.0385	90.0403	90.0421	90.0439
Fig. 7	15 mm	90.0386	90.0404	90.0422	90.0440
Fig. 8	16 mm	90.0387	90.0405	90.0423	90.0441
Fig. 9	19 mm	90.0388	90.0406	90.0424	90.0442
Fig. 10	20 mm	90.0389	90.0407	90.0425	90.0443
Fig. 11	21 mm	90.0390	90.0408	90.0426	90.0444
Fig. 12	23 mm	90.0391	90.0409	90.0427	90.0445
Fig. 13	25 mm	90.0392	90.0410	90.0428	90.0446
Fig. 14	30 mm	90.0393	90.0411	90.0429	90.0447
Fig. 15	35 mm	90.0394	90.0412	90.0430	90.0448
Fig. 16	40 mm	90.0395	90.0413	90.0431	90.0449



16

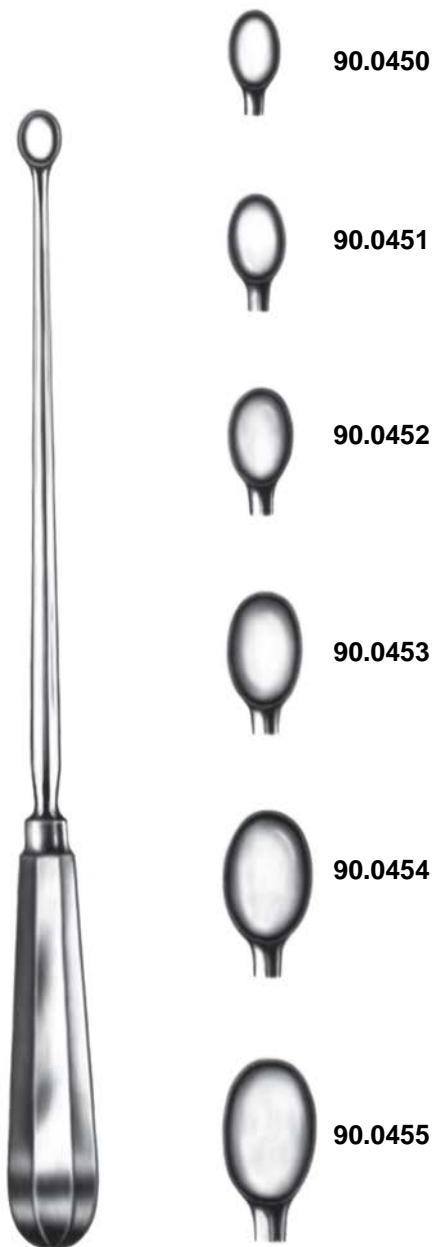

Schroeder 300 mm

ostra, sztywna
sharp, rigid
острая, жёсткая

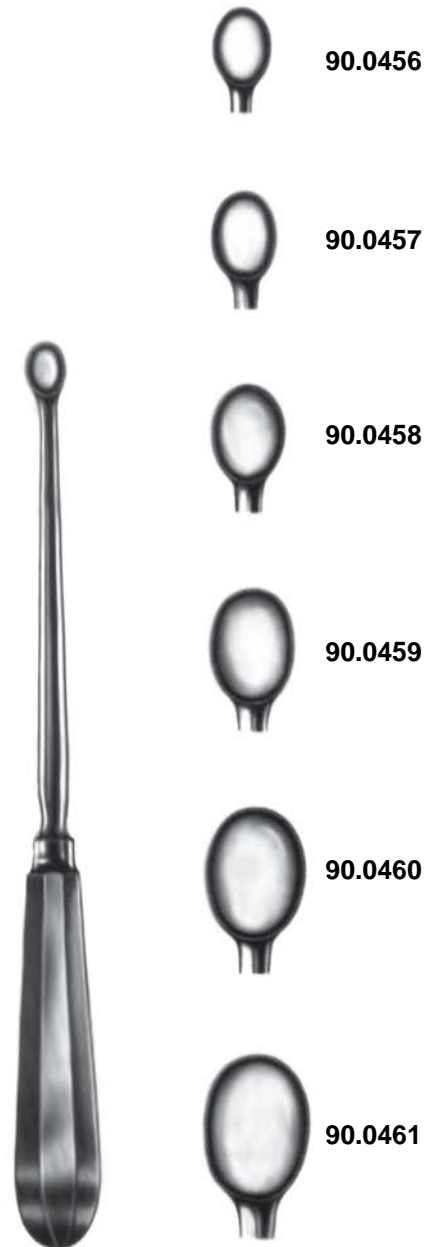

Simon 250 mm

ostra, sztywna
sharp, rigid
острая, жёсткая



Noto
90.0479 270 mm



Kelly
90.0480 320 mm



Doyen
90.0481 170 mm

śruby do mięśniaków
myoma screws
винты для миомы



Doyen
90.0482 170 mm



Winter 280 mm

prosty
straight
прямой

90.0483



90.0484



90.0485



zagięty
curved
загнутый

90.0486

90.0487

90.0488

INNE / OTHERS





Taca z drutu stalowego
Steel wire tray
Поднос из проволоки

12.0318.030 540 x 250 x 30 mm
12.0318.050 540 x 250 x 50 mm
12.0318.070 540 x 250 x 70 mm
12.0318.100 540 x 250 x 100 mm

12.0319.030 405 x 250 x 30 mm
12.0319.050 405 x 250 x 50 mm
12.0319.070 405 x 250 x 70 mm
12.0319.100 405 x 250 x 100 mm

12.0316.043 274 x 172 x 43 mm
12.0317.050 267 x 125 x 50 mm

12.0320.030 480 x 250 x 30 mm
12.0320.050 480 x 250 x 50 mm
12.0320.070 480 x 250 x 70 mm
12.0320.100 480 x 250 x 100 mm

12.0321.030 255 x 250 x 30 mm
12.0321.050 255 x 250 x 50 mm
12.0321.070 255 x 250 x 70 mm
12.0321.100 255 x 250 x 100 mm



Taca z drutu stalowego z pokrywą
Steel wire tray with lid
Поднос из проволоки с крышкой

12.0318.031 540 x 250 x 30 mm
12.0318.051 540 x 250 x 50 mm
12.0318.071 540 x 250 x 70 mm
12.0318.101 540 x 250 x 100 mm

12.0319.031 405 x 250 x 30 mm
12.0319.051 405 x 250 x 50 mm
12.0319.071 405 x 250 x 70 mm
12.0319.101 405 x 250 x 100 mm

12.0316.143 274 x 172 x 43 mm
12.0317.051 267 x 125 x 50 mm

12.0320.031 480 x 250 x 30 mm
12.0320.051 480 x 250 x 50 mm
12.0320.071 480 x 250 x 70 mm
12.0320.101 480 x 250 x 100 mm

12.0321.031 255 x 250 x 30 mm
12.0321.051 255 x 250 x 50 mm
12.0321.071 255 x 250 x 70 mm
12.0321.101 255 x 250 x 100 mm



Taca z drutu stalowego z pokrywą
Steel wire tray with lid
Поднос из проволоки с крышкой

12.0439 670 x 80 x 52 mm
12.0440 460 x 80 x 52 mm
12.0441 290 x 80 x 52 mm

12.0442 640 x 150 x 77 mm



Taca z blachy perforowanej
Perforated sheet tray
Поднос из перфорированного металлического листа

12.0322.030 540 x 253 x 30 mm
12.0322.050 540 x 253 x 50 mm
12.0322.070 540 x 253 x 70 mm
12.0322.100 540 x 253 x 100 mm

12.0323.030 485 x 253 x 30 mm
12.0323.050 485 x 253 x 50 mm
12.0323.070 485 x 253 x 70 mm
12.0323.100 485 x 253 x 100 mm

12.0327.030 405 x 253 x 30 mm
12.0327.050 405 x 253 x 50 mm
12.0327.070 405 x 253 x 70 mm
12.0327.100 405 x 253 x 100 mm

12.0324.030 244 x 253 x 30 mm
12.0324.050 244 x 253 x 50 mm
12.0324.070 244 x 253 x 70 mm
12.0324.100 244 x 253 x 100 mm

12.0325.040 275 x 175 x 40 mm
12.0325.095 275 x 175 x 95 mm
12.0326.050 265 x 125 x 50 mm

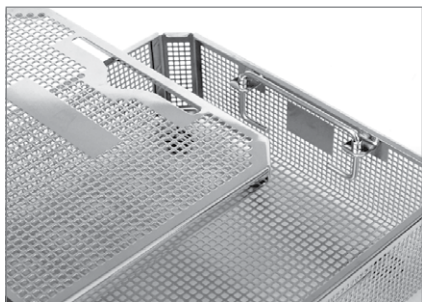

Taca z blachy perforowanej z pokrywą
Perforated sheet tray with lid
Поднос из перфорированного металлического листа с крышкой

12.0322.031 540 x 253 x 30 mm
12.0322.051 540 x 253 x 50 mm
12.0322.071 540 x 253 x 70 mm
12.0322.101 540 x 253 x 100 mm

12.0323.031 485 x 253 x 30 mm
12.0323.051 485 x 253 x 50 mm
12.0323.071 485 x 253 x 70 mm
12.0323.101 485 x 253 x 100 mm

12.0327.031 405 x 253 x 30 mm
12.0327.051 405 x 253 x 50 mm
12.0327.071 405 x 253 x 70 mm
12.0327.101 405 x 253 x 100 mm

12.0324.031 244 x 253 x 30 mm
12.0324.051 244 x 253 x 50 mm
12.0324.071 244 x 253 x 70 mm
12.0324.101 244 x 253 x 100 mm

12.0325.041 275 x 175 x 40 mm
12.0325.195 275 x 175 x 95 mm
12.0326.051 265 x 125 x 50 mm

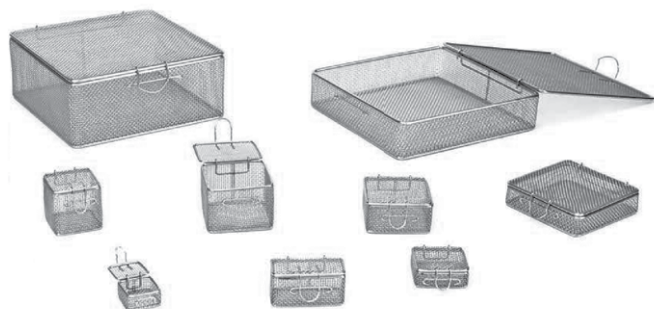

Taca z drutu stalowego
Steel mesh tray
Поддон из нержавеющей проволоки

12.0328.030	30 x 30 x 30 mm
12.0329.020	40 x 40 x 20 mm
12.0329.040	40 x 40 x 40 mm
12.0330.020	60 x 60 x 20 mm
12.0330.040	60 x 60 x 40 mm
12.0330.060	60 x 60 x 60 mm
12.0331.020	80 x 80 x 20 mm
12.0331.140	80 x 40 x 40 mm
12.0331.040	80 x 80 x 40 mm
12.0331.060	80 x 80 x 60 mm
12.0331.080	80 x 80 x 80 mm
12.0332.010	100 x 100 x 10 mm
12.0333.030	120 x 120 x 30 mm
12.0333.060	120 x 120 x 60 mm
12.0333.080	120 x 120 x 80 mm
12.0334.030	240 x 240 x 30 mm
12.0334.060	240 x 240 x 60 mm
12.0334.080	240 x 240 x 80 mm
12.0334.100	240 x 240 x 100 mm



K2-740
Filtr papierowy, jednorazowy, opak. 100 szt.
Single use paper filter, 100 pcs
Бумажный фильтр, одноразовый, 100 шт.

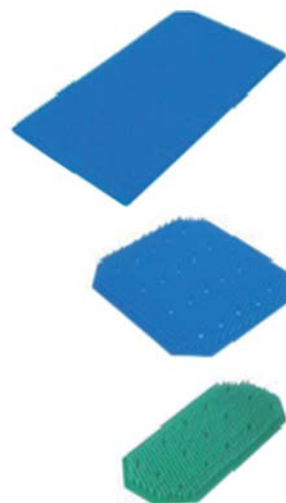

Maty silikonowe
Silicone mats
Силиконовые коврики

12.0718.000	275 x 125 mm
12.0719.000	250 x 235 mm
12.0720.000	300 x 300 mm
12.0721.000	380 x 230 mm
12.0722.000	440 x 230 mm
12.0723.000	520 x 230 mm
12.0724.000	230 x 220 mm
12.0725.000	470 x 230 mm
12.0726.000	260 x 180 mm



12.0727.000	250 x 240 x 2 mm
12.0728.000	480 x 250 x 2 mm



K2-660
Plomby plastikowe, opak. 100 szt.
Plastic security seal, 100 pcs
Пластиковые пломбы, 100 шт.



12.0400.030 230 x 155 x 30 mm
12.0401.030 300 x 175 x 30 mm
12.0401.040 300 x 175 x 40 mm
12.0402.040 350 x 240 x 40 mm
12.0403.050 400 x 300 x 50 mm



12.0411.040 235 x 190 x 40 mm



12.0404.010 210 x 160 x 10 mm
12.0405.010 240 x 180 x 10 mm
12.0406.010 310 x 150 x 10 mm
12.0407.010 310 x 210 x 10 mm
12.0408.010 350 x 240 x 10 mm
12.0409.020 400 x 270 x 20 mm
12.0410.010 420 x 280 x 10 mm



12.0412.040 100 x 60 x 40 mm
12.0413.040 120 x 80 x 40 mm
12.0414.030 160 x 100 x 30 mm
12.0415.035 170 x 90 x 35 mm
12.0416.050 180 x 120 x 50 mm
12.0417.050 200 x 100 x 50 mm
12.0418.050 220 x 150 x 50 mm
12.0419.050 260 x 150 x 50 mm
12.0420.050 300 x 200 x 50 mm
12.0421.050 310 x 201 x 50 mm
12.0422.080 400 x 200 x 80 mm
12.0423.070 500 x 270 x 70 mm



12.0424.040 180 x 80 x 40 mm
12.0425.060 200 x 100 x 60 mm
12.0426.060 220 x 120 x 60 mm
12.0427.060 250 x 120 x 60 mm
12.0428.060 300 x 125 x 60 mm
12.0429.060 320 x 150 x 60 mm
12.0430.120 500 x 200 x 120 mm



30.4300	40 mm
30.4301	60 mm
30.4302	80 mm
30.4303	100 mm
30.4304	120 mm
30.4305	150 mm



30.4306	165 x 60 mm	0,75 l
30.4307	175 x 70 mm	1,00 l
30.4308	220 x 80 mm	2,00 l
30.4309	225 x 90 mm	2,50 l
30.4310	240 x 110 mm	3,00 l
30.4311	255 x 115 mm	4,00 l
30.4312	275 x 115 mm	4,50 l
30.4313	290 x 125 mm	6,00 l
30.4314	310 x 120 mm	6,00 l
30.4315	345 x 125 mm	8,50 l
30.4316	380 x 130 mm	11,00 l
30.4317	415 x 140 mm	14,00 l



30.4318	70 mm	0,25 l
30.4319	110 mm	0,50 l
30.4320	140 mm	1,00 l
30.4321	160 mm	1,50 l
30.4322	180 mm	2,00 l



30.4323	170 mm
30.4324	200 mm
30.4325	250 mm
30.4326	270 mm



30.4330	40 x 19 mm	0,05 l
30.4331	61 x 30 mm	0,07 l
30.4332	80 x 40 mm	0,14 l
30.4333	116 x 50 mm	0,35 l
30.4334	128 x 55 mm	0,45 l
30.4335	147 x 65 mm	0,70 l
30.4336	210 x 90 mm	2,50 l

Catalogue no. Nr katalogowy	Page Strona	Catalogue no. Nr katalogowy	Page Strona	Catalogue no. Nr katalogowy	Page Strona	Catalogue no. Nr katalogowy	Page Strona
12.0316.043	165	12.0331.060	167	30.0094.100	49	30.0191	21
12.0316.143	165	12.0331.140	167	30.0095	49	30.0192	21
12.0317.050	165	12.0332.010	167	30.0098	8	30.0193	21
12.0317.051	165	12.0333.030	167	30.0099	8	30.0194	21
12.0318.030	165	12.0333.060	167	30.0100	49	30.0195	21
12.0318.031	165	12.0333.080	167	30.0101	49	30.0196	21
12.0318.050	165	12.0334.030	167	30.0102	49	30.0197	21
12.0318.051	165	12.0334.060	167	30.0103	49	30.0198	21
12.0318.070	165	12.0334.080	167	30.0104	49	30.0199	21
12.0318.071	165	12.0334.100	167	30.0104.100	49	30.0200	21
12.0318.100	165	12.0400.030	168	30.0105	49	30.0201	21
12.0318.101	165	12.0401.030	168	30.0105.100	49	30.0202	21
12.0319.030	165	12.0401.040	168	30.0121	21	30.0203	21
12.0319.031	165	12.0402.040	168	30.0122	21	30.0204	21
12.0319.050	165	12.0403.050	168	30.0123	21	30.0205	21
12.0319.051	165	12.0404.010	168	30.0124	21	30.0206	21
12.0319.070	165	12.0405.010	168	30.0125	21	30.0207	21
12.0319.071	165	12.0406.010	168	30.0126	21	30.0208	21
12.0319.100	165	12.0407.010	168	30.0127	21	30.0209	21
12.0319.101	165	12.0408.010	168	30.0128	21	30.0210	21
12.0320.030	165	12.0409.020	168	30.0129	21	30.0211	50
12.0320.031	165	12.0410.010	168	30.0130	21	30.0212	50
12.0320.050	165	12.0411.040	168	30.0131	21	30.0213	50
12.0320.051	165	12.0412.040	168	30.0132	21	30.0214	50
12.0320.070	165	12.0413.040	168	30.0133	21	30.0215	50
12.0320.071	165	12.0414.030	168	30.0134	21	30.0216	50
12.0320.100	165	12.0415.035	168	30.0135	21	30.0217	50
12.0320.101	165	12.0416.050	168	30.0136	21	30.0218	50
12.0321.030	165	12.0417.050	168	30.0137	21	30.0219	50
12.0321.031	165	12.0418.050	168	30.0138	21	30.0220	50
12.0321.050	165	12.0419.050	168	30.0139	21	30.0221.000	51
12.0321.051	165	12.0420.050	168	30.0140	21	30.0221.130	51
12.0321.070	165	12.0421.050	168	30.0141	21	30.0222.000	51
12.0321.071	165	12.0422.080	168	30.0142	21	30.0222.130	51
12.0321.100	165	12.0423.070	168	30.0143	21	30.0223	51
12.0321.101	165	12.0424.040	168	30.0144	21	30.0224	51
12.0322.030	166	12.0425.060	168	30.0145	21	30.0225	51
12.0322.031	166	12.0426.060	168	30.0146	21	30.0226	51
12.0322.050	166	12.0427.060	168	30.0147	21	30.0227	51
12.0322.051	166	12.0428.060	168	30.0148	21	30.0228	51
12.0322.070	166	12.0429.060	168	30.0149	21	30.0229	51
12.0322.071	166	12.0430.120	168	30.0150	21	30.0230	51
12.0322.100	166	12.0439	165	30.0151	21	30.0231	51
12.0322.101	166	12.0440	165	30.0152	21	30.0232	51
12.0323.030	166	12.0441	165	30.0153	21	30.0233	51
12.0323.031	166	12.0442	165	30.0154	21	30.0234	51
12.0323.050	166	12.0718.000	167	30.0155	21	30.0235	51
12.0323.051	166	12.0719.000	167	30.0156	21	30.0236	51
12.0323.070	166	12.0720.000	167	30.0157	21	30.0237	51
12.0323.071	166	12.0721.000	167	30.0158	21	30.0238	51
12.0323.100	166	12.0722.000	167	30.0159	21	30.0239	51
12.0323.101	166	12.0723.000	167	30.0160	21	30.0240	51
12.0324.030	166	12.0724.000	167	30.0161	21	30.0241	51
12.0324.031	166	12.0725.000	167	30.0162	21	30.0242	51
12.0324.050	166	12.0726.000	167	30.0163	21	30.0243	51
12.0324.051	166	12.0727.000	167	30.0164	21	30.0244	51
12.0324.070	166	12.0728.000	167	30.0165	21	30.0245	51
12.0324.071	166	30.0041	8	30.0166	21	30.0246	51
12.0324.100	166	30.0042	8	30.0167	21	30.0247	51
12.0324.101	166	30.0043	8	30.0168	21	30.0248	51
12.0325.040	166	30.0044	8	30.0169	21	30.0249	51
12.0325.041	166	30.0046	8	30.0170	21	30.0250	51
12.0325.095	166	30.0054	50	30.0171	21	30.0251	51
12.0325.195	166	30.0056	50	30.0172	21	30.0252	51
12.0326.050	166	30.0057	50	30.0173	21	30.0253	51
12.0326.051	166	30.0058	50	30.0174	21	30.0254	51
12.0327.030	166	30.0080	49	30.0175	21	30.0255	51
12.0327.031	166	30.0081	49	30.0176	21	30.0256	51
12.0327.050	166	30.0082	49	30.0177	21	30.0257	51
12.0327.051	166	30.0083	49	30.0178	21	30.0258	51
12.0327.070	166	30.0084	49	30.0179	21	30.0259.000	51
12.0327.071	166	30.0085	49	30.0180	21	30.0259.160	51
12.0327.100	166	30.0086	49	30.0181	21	30.0260.000	51
12.0327.101	166	30.0087	49	30.0182	21	30.0260.160	51
12.0328.030	167	30.0088	49	30.0183	21	30.0261	52
12.0329.020	167	30.0089	49	30.0184	21	30.0262	52
12.0329.040	167	30.0090	49	30.0185	21	30.0263	52
12.0330.020	167	30.0091	49	30.0186	21	30.0264	52
12.0330.040	167	30.0092	49	30.0187	21	30.0265	52
12.0330.060	167	30.0092.100	49	30.0188	21	30.0266	52
12.0331.020	167	30.0093	49	30.0189	21	30.0267	52
12.0331.040	167	30.0094	49	30.0190	21	30.0268	52

Catalogue no. Nr katalogowy	Page Strona	Catalogue no. Nr katalogowy	Page Strona	Catalogue no. Nr katalogowy	Page Strona	Catalogue no. Nr katalogowy	Page Strona
30.0269	50	30.1057	92	30.1146	96	30.1243	105
30.0270	50	30.1058	92	30.1147	96	30.1244	105
30.0271	52	30.1059	92	30.1148	96	30.1245	105
30.0272	52	30.1060	92	30.1149	96	30.1246	105
30.0273	52	30.1061	92	30.1150	96	30.1247	105
30.0274	52	30.1062	92	30.1151	96	30.1248	105
30.0275	53	30.1063	92	30.1152	96	30.1249	105
30.0276	53	30.1064	92	30.1153	97	30.1250	105
30.0277	53	30.1065	92	30.1154	97	30.1251	105
30.0278	53	30.1066	92	30.1155	97	30.1252	105
30.0279	53	30.1067	92	30.1156	97	30.1253	105
30.0280	53	30.1068	92	30.1157	97	30.1254	105
30.0281	53	30.1069	92	30.1158	97	30.1255	105
30.0282	53	30.1070	92	30.1159	97	30.1256	105
30.0283	53	30.1071	92	30.1160	97	30.1257	105
30.0284	53	30.1072	93	30.1161	97	30.1258	105
30.0285	53	30.1073	93	30.1162	97	30.1259	105
30.0286	53	30.1074	93	30.1163	97	30.1260	105
30.0287	53	30.1075	93	30.1167	98	30.1261	105
30.0288	53	30.1076	93	30.1168	97	30.1262	106
30.0289	53	30.1077	93	30.1169	97	30.1263	106
30.0290	53	30.1078	93	30.1170	97	30.1264	106
30.0291	53	30.1079	93	30.1171	97	30.1265	106
30.0292	53	30.1080	93	30.1172	97	30.1266	106
30.0293	53	30.1081	93	30.1173	98	30.1267	106
30.0294	53	30.1082	93	30.1174	97	30.1268	106
30.0295	57	30.1083	93	30.1175	97	30.1269	106
30.0296	57	30.1084	93	30.1176	97	30.1270	106
30.0297	57	30.1085	93	30.1177	97	30.1271	106
30.0298	57	30.1086	93	30.1178	97	30.1272	106
30.0299	57	30.1087	93	30.1179	97	30.1273	106
30.1002	89	30.1088	93	30.1180	98	30.1274	106
30.1004	89	30.1089	93	30.1181	98	30.1275	106
30.1005	89	30.1090	93	30.1182	98	30.1276	106
30.1006	89	30.1091	94	30.1183	98	30.1277	106
30.1007	89	30.1092	94	30.1184	98	30.1278	106
30.1008	89	30.1093	94	30.1185	99	30.1279	106
30.1009	89	30.1094	94	30.1186	99	30.1280	106
30.1010	89	30.1095	94	30.1187	99	30.1281	106
30.1011	89	30.1096	94	30.1188	99	30.1282	106
30.1012	89	30.1098	94	30.1189	99	30.1283	106
30.1013	89	30.1099	94	30.1190	99	30.1284	107
30.1015	112	30.1103	94	30.1191	99	30.1285	107
30.1016	90	30.1104	94	30.1192	99	30.1286	107
30.1017	90	30.1105	94	30.1193	99	30.1287	107
30.1018	90	30.1106	94	30.1195	99	30.1288	107
30.1019	90	30.1107	94	30.1196	99	30.1289	107
30.1020	90	30.1108	94	30.1197	99	30.1290	107
30.1021	90	30.1109	94	30.1198	100	30.1291	107
30.1022	90	30.1110	94	30.1199	100	30.1292	108
30.1023	90	30.1111	94	30.1200	100	30.1293	108
30.1024	90	30.1112	94	30.1201	100	30.1294	108
30.1025	90	30.1113	94	30.1202	100	30.1295	108
30.1026	90	30.1114	94	30.1203	100	30.1296	108
30.1027	91	30.1115	94	30.1204	100	30.1297	108
30.1028	91	30.1116	95	30.1205	100	30.1298	108
30.1029	91	30.1117	95	30.1206	100	30.1299	108
30.1030	91	30.1119	95	30.1207	100	30.1300	109
30.1031	91	30.1121	95	30.1208	101	30.1301	109
30.1032	91	30.1123	95	30.1209	101	30.1302	109
30.1033	91	30.1124	95	30.1210	101	30.1303	109
30.1034	91	30.1125	95	30.1211	101	30.1304	109
30.1035	91	30.1126	95	30.1212	102	30.1305	109
30.1037	90	30.1127	95	30.1213	102	30.1306	110
30.1038	90	30.1128	95	30.1214	102	30.1307	110
30.1039	90	30.1129	95	30.1215	102	30.1308	110
30.1041	90	30.1130	95	30.1216	102	30.1312	110
30.1042	91	30.1131	95	30.1226	103	30.1313	110
30.1043	91	30.1132	95	30.1227	103	30.1314	110
30.1044	91	30.1133	96	30.1228	103	30.1315	111
30.1045	91	30.1134	96	30.1229	103	30.1316	111
30.1046	91	30.1135	96	30.1230	97	30.1317	111
30.1047	91	30.1136	96	30.1231	97	30.1321	111
30.1048	92	30.1137	96	30.1232	97	30.1322	111
30.1049	92	30.1138	96	30.1233	97	30.1323	111
30.1050	92	30.1139	96	30.1234	104	30.1324	112
30.1051	92	30.1140	96	30.1235	104	30.1329	112
30.1052	92	30.1141	96	30.1236	104	30.1330	112
30.1053	92	30.1142	96	30.1237	104	30.1331	112
30.1054	92	30.1143	96	30.1238	104	30.1332	112
30.1055	92	30.1144	96	30.1239	104	30.1334	112
30.1056	92	30.1145	96	30.1240	104	30.1335	112

Catalogue no. Nr katalogowy	Page Strona	Catalogue no. Nr katalogowy	Page Strona	Catalogue no. Nr katalogowy	Page Strona	Catalogue no. Nr katalogowy	Page Strona
30.1336	112	30.1434	88	30.1513	134	30.1929	56
30.1337	113	30.1435	88	30.1514	134	30.1930	56
30.1338	113	30.1436	88	30.1515	134	30.1931	56
30.1339	113	30.1437	88	30.1516	134	30.1932	56
30.1340	113	30.1438	125	30.1517	135	30.1935	56
30.1342	113	30.1439	125	30.1518	135	30.1936	67
30.1343	113	30.1440	125	30.1519	136	30.1937	84
30.1344	113	30.1441	125	30.1520	136	30.1938	84
30.1345	113	30.1442	126	30.1521	136	30.1939	84
30.1346	113	30.1443	126	30.1522	136	30.1940	84
30.1348	113	30.1445	126	30.1523	136	30.1941	84
30.1350	114	30.1446	126	30.1525	136	30.1942	84
30.1352	114	30.1447	126	30.1526	137	30.1943	85
30.1354	114	30.1450	126	30.1527	137	30.1944	85
30.1355	114	30.1451	126	30.1528	137	30.1945	85
30.1356	114	30.1452	126	30.1529	137	30.1946	85
30.1357	114	30.1453	126	30.1530	137	30.1947	71
30.1358	115	30.1454	126	30.1531	137	30.1948	71
30.1359	115	30.1455	126	30.1532	137	30.1949	71
30.1360	115	30.1456	126	30.1533	124	30.1950	71
30.1361	115	30.1457	126	30.1534	124	30.1951	71
30.1362	115	30.1458	127	30.1535	124	30.1952	71
30.1363	115	30.1459	127	30.1536	124	30.1953	85
30.1364	116	30.1460	127	30.1537	124	30.1954	85
30.1365	116	30.1461	127	30.1538	124	30.1955	85
30.1366	116	30.1462	127	30.1539	124	30.1956	58
30.1367	116	30.1463	127	30.1540	124	30.2000	57
30.1368	116	30.1464	127	30.1541	124	30.2001	57
30.1369	116	30.1465	127	30.1542	124	30.2002	57
30.1370	116	30.1466	127	30.1543	124	30.2003	57
30.1371	117	30.1467	127	30.1544	124	30.2004	57
30.1372	117	30.1468	127	30.1545	124	30.2005	57
30.1373	117	30.1469	128	30.1548	128	30.2006	57
30.1374	117	30.1470	128	30.1550	138	30.2007	57
30.1375	117	30.1471	128	30.1551	138	30.2008	57
30.1376	117	30.1472	128	30.1552	138	30.2009	57
30.1377	118	30.1473	128	30.1553	138	30.2010	57
30.1378	118	30.1474	128	30.1554	139	30.2011	57
30.1379	118	30.1475	128	30.1555	139	30.2012	57
30.1380	118	30.1476	128	30.1556	140	30.2013	57
30.1381	118	30.1477	128	30.1557	140	30.2014	58
30.1382	118	30.1478	128	30.1558	140	30.2015	58
30.1383	119	30.1479	128	30.1559	141	30.2016	58
30.1384	119	30.1480	128	30.1560	141	30.2017	58
30.1385	119	30.1481	128	30.1561	141	30.2018	58
30.1387	119	30.1482.000	129	30.1562	141	30.2019	58
30.1388	119	30.1482.100	129	30.1592	125	30.2020	58
30.1389	119	30.1483	129	30.1593	125	30.2021	58
30.1390	120	30.1484	129	30.1653.001	90	30.2022	58
30.1391	120	30.1485	129	30.1653.002	90	30.2023	59
30.1392	120	30.1486	129	30.1653.005	90	30.2024	59
30.1393	120	30.1487	130	30.1653.007	90	30.2025	59
30.1394	120	30.1488	130	30.1653.010	90	30.2026	59
30.1395	120	30.1489	130	30.1900	54	30.2027	59
30.1396	120	30.1490	130	30.1901	54	30.2028	59
30.1397	120	30.1491	130	30.1902	54	30.2029	59
30.1402	121	30.1491.025	130	30.1903	54	30.2030	59
30.1403	121	30.1492	130	30.1904	54	30.2031	59
30.1404	121	30.1492.025	130	30.1905	54	30.2032	60
30.1405	121	30.1493	131	30.1906	54	30.2033	60
30.1412	122	30.1493.035	131	30.1907	54	30.2036	60
30.1413	122	30.1494	131	30.1908	54	30.2037	60
30.1414	122	30.1494.035	131	30.1909	54	30.2039	60
30.1415	122	30.1495	131	30.1910	54	30.2041	60
30.1416	122	30.1495.100	131	30.1911	54	30.2042	60
30.1417	123	30.1495.200	131	30.1912	55	30.2043	61
30.1418	123	30.1496	131	30.1913	55	30.2044	61
30.1419	123	30.1497.000	131	30.1914	55	30.2045	61
30.1420	87	30.1497.100	131	30.1915	55	30.2046	61
30.1421	87	30.1498	132	30.1916	55	30.2047	61
30.1422	87	30.1499	132	30.1917	55	30.2048	61
30.1423	87	30.1500	132	30.1918	55	30.2049	61
30.1424	87	30.1501	132	30.1919	55	30.2050	61
30.1425	87	30.1502	132	30.1920	55	30.2051	61
30.1426	87	30.1503	133	30.1921	55	30.2052	61
30.1427	87	30.1504	133	30.1922	55	30.2053	61
30.1428	87	30.1507	133	30.1923	55	30.2054	61
30.1429	87	30.1508	134	30.1924	56	30.2055	61
30.1430	87	30.1509	134	30.1925	56	30.2056.100	61
30.1431	88	30.1510	134	30.1926	56	30.2057	62
30.1432	88	30.1511	134	30.1927	56	30.2058	62
30.1433	88	30.1512	134	30.1928	56	30.2059	62

Catalogue no. Nr katalogowy	Page Strona	Catalogue no. Nr katalogowy	Page Strona	Catalogue no. Nr katalogowy	Page Strona	Catalogue no. Nr katalogowy	Page Strona
30.2059.145	62	30.2142	68	30.2226	76	30.2352	22
30.2060	62	30.2143	68	30.2227	76	30.2353	22
30.2061	62	30.2144	68	30.2228	76	30.2354	22
30.2062	62	30.2145	68	30.2229	76	30.2355	22
30.2063	62	30.2146	69	30.2230	79	30.2356	23
30.2064	62	30.2147	69	30.2231	79	30.2357	23
30.2065	62	30.2148	69	30.2232	79	30.2358	23
30.2066	62	30.2149	69	30.2233	79	30.2359	23
30.2068	63	30.2150	69	30.2234	79	30.2360	23
30.2069	63	30.2151	69	30.2235	79	30.2361	23
30.2070	63	30.2152	69	30.2236	79	30.2362	23
30.2071	63	30.2153	69	30.2237	79	30.2363	23
30.2072	63	30.2154	69	30.2238	79	30.2364	23
30.2073	63	30.2155	69	30.2239	79	30.2365	23
30.2074	63	30.2156	69	30.2240	79	30.2366	23
30.2075	63	30.2158	69	30.2241	79	30.2367	23
30.2076	63	30.2159	69	30.2242	79	30.2368	23
30.2077	63	30.2160	69	30.2243	79	30.2369	23
30.2078	63	30.2161	69	30.2244	79	30.2370	23
30.2079	63	30.2162	69	30.2245	79	30.2371	24
30.2080	63	30.2163	69	30.2247	79	30.2372	24
30.2082	64	30.2164	69	30.2248	79	30.2373.000	24
30.2083	64	30.2165	69	30.2249	79	30.2373.100	24
30.2084	64	30.2167	70	30.2250	79	30.2374.000	24
30.2085	64	30.2168	70	30.2251	79	30.2374.100	24
30.2086	64	30.2169	70	30.2252	82	30.2375	24
30.2087	64	30.2170	70	30.2253	82	30.2376	24
30.2088	64	30.2171	70	30.2254	82	30.2378	24
30.2089	64	30.2172	70	30.2255	82	30.2380	24
30.2089.250	64	30.2173	70	30.2256	82	30.2381	24
30.2090	64	30.2174	70	30.2257	82	30.2382	24
30.2090.250	64	30.2175	70	30.2258	82	30.2383	21
30.2091	65	30.2176	70	30.2259	82	30.2384	21
30.2092	65	30.2177	70	30.2261	83	30.2385	21
30.2093	65	30.2178	70	30.2262	83	30.2386	21
30.2094	65	30.2179	70	30.2263	83	30.2387	21
30.2095	65	30.2180	70	30.2264	83	30.2388	21
30.2095.270	65	30.2181	70	30.2265	83	30.2395	25
30.2096	65	30.2182	70	30.2266	81	30.2396	25
30.2097	65	30.2183	70	30.2267	81	30.2397	26
30.2097.270	65	30.2184	71	30.2268	81	30.2398	26
30.2098	65	30.2185	71	30.2269	81	30.2399	26
30.2099	65	30.2186	71	30.2270	81	30.2400	26
30.2100	65	30.2187	71	30.2271	81	30.2401	25
30.2101	65	30.2188	71	30.2272	81	30.2402	25
30.2102	66	30.2189	71	30.2273	81	30.2403	25
30.2103	66	30.2190	72	30.2274	81	30.2404	25
30.2104	66	30.2191	72	30.2275	81	30.2405	25
30.2105	66	30.2192	72	30.2276	81	30.2406	25
30.2106	66	30.2193	72	30.2277	81	30.2407	25
30.2107	66	30.2194	72	30.2278	81	30.2408	25
30.2108	66	30.2195	72	30.2279	81	30.2409	25
30.2109	66	30.2196	72	30.2280	81	30.2410	25
30.2114	66	30.2197	72	30.2281	81	30.2411	26
30.2115	66	30.2198	72	30.2328.010	22	30.2412	26
30.2117	66	30.2199	72	30.2328.011	22	30.2413	26
30.2119	66	30.2200	73	30.2328.012	22	30.2414	26
30.2120	66	30.2201	73	30.2328.090	22	30.2415	26
30.2121.000	67	30.2202	73	30.2329.010	22	30.2416	26
30.2121.180	67	30.2203	73	30.2329.011	22	30.2417	26
30.2122.000	67	30.2204	73	30.2329.012	22	30.2418	26
30.2122.180	67	30.2205	73	30.2329.090	22	30.2419	27
30.2123	67	30.2206	73	30.2331	22	30.2420	27
30.2124	67	30.2207	73	30.2332	22	30.2421	27
30.2125	67	30.2208	74	30.2333	22	30.2422	27
30.2127	67	30.2209	74	30.2335	22	30.2423	27
30.2128	67	30.2210	74	30.2336	22	30.2424	27
30.2129	67	30.2211	74	30.2337	22	30.2425	27
30.2130	53	30.2212	74	30.2338	22	30.2427	28
30.2130.000	67	30.2213	74	30.2339	22	30.2428	28
30.2130.150	67	30.2214	74	30.2340	22	30.2429	28
30.2131	68	30.2215	74	30.2341	22	30.2430	28
30.2132	68	30.2216	74	30.2342	22	30.2431	28
30.2133	68	30.2217	75	30.2343	22	30.2432	28
30.2134	68	30.2218	75	30.2344	22	30.2433	28
30.2135	68	30.2219	75	30.2345	22	30.2434	28
30.2136	68	30.2220	75	30.2346	22	30.2435	28
30.2137	68	30.2221	75	30.2347	22	30.2436	29
30.2138	68	30.2222	75	30.2348	22	30.2437	29
30.2139	68	30.2223	75	30.2349	22	30.2438	29
30.2140	68	30.2224	75	30.2350	22	30.2439	29
30.2141	68	30.2225	76	30.2351	22	30.2440	32

Catalogue no. Nr katalogowy	Page Strona	Catalogue no. Nr katalogowy	Page Strona	Catalogue no. Nr katalogowy	Page Strona	Catalogue no. Nr katalogowy	Page Strona
30.2441	30	30.2529	78	30.2696	19	30.2781	18
30.2443	30	30.2530	78	30.2699	81	30.2782	18
30.2444	30	30.2531	27	30.2700	12	30.2783	18
30.2446	30	30.2532	37	30.2701	12	30.2784	18
30.2447	30	30.2533	37	30.2702	12	30.2785	18
30.2448	30	30.2533.230	37	30.2703	12	30.2786	18
30.2449	30	30.2534	37	30.2704	12	30.2787	18
30.2450	31	30.2535	37	30.2705	12	30.2788	18
30.2451	31	30.2535.230	37	30.2706	12	30.2789	18
30.2452	31	30.2536	37	30.2707	12	30.2790	18
30.2453	31	30.2537	37	30.2708	12	30.2791	18
30.2454	31	30.2538	37	30.2709	12	30.2792	18
30.2455	31	30.2539	37	30.2710	12	30.2793	18
30.2456	31	30.2540	37	30.2711	12	30.2794	18
30.2457	31	30.2541	37	30.2712	12	30.2795	19
30.2458	31	30.2542	37	30.2713	12	30.2796	19
30.2459	31	30.2543	37	30.2715	12	30.2797	19
30.2460	31	30.2544	37	30.2716	12	30.2798	19
30.2461	32	30.2545	37	30.2717	12	30.2799	19
30.2462	32	30.2546	38	30.2718	12	30.2800	19
30.2466	30	30.2547	38	30.2719	12	30.2801	19
30.2467	30	30.2548	38	30.2720	13	30.2802	19
30.2468	30	30.2549	38	30.2721	13	30.2803	19
30.2469	30	30.2550	38	30.2722	13	30.2804	19
30.2470	30	30.2551	38	30.2723	13	30.2805	19
30.2471	30	30.2552	38	30.2724	13	30.2806	19
30.2472	34	30.2553	38	30.2725	13	30.2807	19
30.2473	34	30.2554	38	30.2726	14	30.2808	19
30.2474	34	30.2555	38	30.2727	14	30.2809	19
30.2475	34	30.2556	38	30.2728	14	30.2810	19
30.2476	34	30.2557	37	30.2729	14	30.2811	19
30.2477	34	30.2558	37	30.2730	13	30.2812	19
30.2478	34	30.2559	37	30.2731	13	30.2814	20
30.2479	34	30.2560	37	30.2732	14	30.2815.000	20
30.2480	34	30.2561	37	30.2733	14	30.2815.140	20
30.2481	34	30.2562	37	30.2734	15	30.2816	20
30.2482	34	30.2563	37	30.2735	15	30.2817	20
30.2483	34	30.2564	37	30.2736	15	30.2818	20
30.2484	34	30.2565	37	30.2737	15	30.2819	20
30.2485	34	30.2566	37	30.2738	15	30.2820	20
30.2486	34	30.2567	38	30.2739	15	30.2821	20
30.2487	34	30.2568	38	30.2740	15	30.2822	20
30.2488	34	30.2570	29	30.2741	15	30.2823	20
30.2489	34	30.2571	29	30.2742	15	30.2827	32
30.2490	34	30.2572	29	30.2743	15	30.2828	32
30.2491	34	30.2573	29	30.2744	15	30.2829	32
30.2492	34	30.2574	29	30.2745	15	30.2830	32
30.2493	34	30.2575	29	30.2746	16	30.2831	32
30.2494	34	30.2576	29	30.2747	16	30.2832	32
30.2495	35	30.2577	23	30.2748	16	30.3300	39
30.2496	35	30.2578	23	30.2749	16	30.3301	39
30.2497	35	30.2579	23	30.2750	16	30.3302	39
30.2498	35	30.2580	36	30.2751	16	30.3303	39
30.2499	35	30.2581	36	30.2752	16	30.3304	39
30.2500	35	30.2582	36	30.2753	16	30.3305	39
30.2501	35	30.2583	36	30.2754	16	30.3306	39
30.2502	35	30.2584	36	30.2755	16	30.3307	39
30.2503	35	30.2585	36	30.2756	16	30.3308	39
30.2505	35	30.2586	36	30.2757	16	30.3309	39
30.2506	35	30.2587	36	30.2758	16	30.3310	39
30.2507	35	30.2588	36	30.2759	17	30.3311	39
30.2508	35	30.2589	36	30.2760	17	30.3312	39
30.2509	35	30.2680	14	30.2761	17	30.3313	39
30.2510	36	30.2681	14	30.2762	17	30.3314	39
30.2511	36	30.2683	16	30.2763	17	30.3315	39
30.2512	77	30.2684	16	30.2764	17	30.3316	39
30.2513	77	30.2685.140	20	30.2765	17	30.3317	39
30.2514	77	30.2685.180	20	30.2766	17	30.3318	39
30.2515	77	30.2685.220	20	30.2767	17	30.3319	39
30.2516	77	30.2686.140	20	30.2768	17	30.3320	39
30.2517	77	30.2686.180	20	30.2769	17	30.3321	39
30.2518	77	30.2686.220	20	30.2770	17	30.3322	39
30.2519	77	30.2687.140	20	30.2771	17	30.3323	39
30.2520	78	30.2688.140	20	30.2772	17	30.3324	39
30.2521	78	30.2689.140	20	30.2773	17	30.3325	39
30.2522	78	30.2689.180	20	30.2774	17	30.3326	39
30.2523	78	30.2690	17	30.2775	17	30.3327	39
30.2524	78	30.2691	17	30.2776	18	30.3328	39
30.2525	78	30.2692	17	30.2777	18	30.3329	39
30.2526	78	30.2693	17	30.2778	18	30.3330	39
30.2527	78	30.2694	19	30.2779	18	30.3331	39
30.2528	78	30.2695	19	30.2780	18	30.3332	39

Catalogue no. Nr katalogowy	Page Strona	Catalogue no. Nr katalogowy	Page Strona	Catalogue no. Nr katalogowy	Page Strona	Catalogue no. Nr katalogowy	Page Strona
30.3333	39	30.3416	41	30.3594	46	30.4323	169
30.3334	39	30.3417	41	30.3595	46	30.4324	169
30.3335	39	30.3418	41	30.3598	47	30.4325	169
30.3336	39	30.3419	41	30.3599	47	30.4326	169
30.3337	39	30.3420	41	30.3600	47	30.4330	169
30.3338	39	30.3421	41	30.3601	47	30.4331	169
30.3339	39	30.3422	41	30.3602	47	30.4332	169
30.3340	39	30.3429	41	30.3603	47	30.4333	169
30.3341	39	30.3430	41	30.3604	47	30.4334	169
30.3342	39	30.3431	41	30.3605	48	30.4335	169
30.3343	39	30.3432	41	30.3606	48	30.4336	169
30.3344	39	30.3434	41	30.3607	48	30.4350	8
30.3345	39	30.3441	42	30.3608	48	40.3284	33
30.3346	39	30.3442	42	30.3609	48	40.3285	33
30.3347	39	30.3449.000	42	30.3610	48	40.3286	33
30.3348	39	30.3449.007	42	30.3611	48	40.3287	33
30.3349	39	30.3450	42	30.3612	48	40.4139	33
30.3350	39	30.3452	42	30.3613	48	40.4140	33
30.3351	39	30.3453	42	30.3614	48	40.4141	33
30.3352	39	30.3454	42	30.3615	48	40.4142	33
30.3353	39	30.3455	42	30.3616	48	40.4143	33
30.3357	39	30.3456	42	30.3617	48	40.4144	33
30.3358	39	30.3457	42	30.3618	48	40.4145	33
30.3359.000	39	30.3458	43	30.3619	48	40.6792	132
30.3359.150	39	30.3459	43	30.3620	48	40.7216	98
30.3360.000	39	30.3460	43	30.3621	48	90.0001	144
30.3360.150	39	30.3461	43	30.4160	9	90.0005	144
30.3361	39	30.3462	43	30.4161	9	90.0006	144
30.3362	39	30.3463	43	30.4162	9	90.0007	144
30.3363	39	30.3464	43	30.4163	9	90.0008	145
30.3364	39	30.3465	43	30.4164	9	90.0010	145
30.3365	40	30.3466	43	30.4165	9	90.0012	145
30.3366	40	30.3467	43	30.4166	10	90.0013	145
30.3367	40	30.3468	43	30.4167	10	90.0014	146
30.3368	40	30.3469	43	30.4168	10	90.0015	146
30.3369	40	30.3470	43	30.4184	10	90.0016	146
30.3370	40	30.3471	43	30.4185	10	90.0019	146
30.3371	40	30.3472	43	30.4186	10	90.0020	146
30.3372	40	30.3473	43	30.4187	11	90.0021	146
30.3373	40	30.3474.000	43	30.4188	11	90.0022	147
30.3374	40	30.3474.180	43	30.4189	11	90.0023	147
30.3375	40	30.3475	43	30.4190	11	90.0026	147
30.3376	40	30.3480	44	30.4191	11	90.0027	147
30.3377	40	30.3481	44	30.4192	11	90.0028	147
30.3378	40	30.3482	44	30.4193	11	90.0030	148
30.3379	40	30.3483	44	30.4194	11	90.0031	148
30.3380	41	30.3484	44	30.4195	11	90.0032	148
30.3381	41	30.3485	44	30.4196	11	90.0033	148
30.3382	41	30.3486	44	30.4197	11	90.0100	149
30.3383	41	30.3487	44	30.4198	11	90.0101	149
30.3384	41	30.3488	44	30.4215	10	90.0102	149
30.3385	41	30.3489	44	30.4216	10	90.0103	149
30.3386	41	30.3490	44	30.4217	10	90.0104	149
30.3387	41	30.3491	44	30.4230	86	90.0105	149
30.3388	41	30.3492	44	30.4231	86	90.0106	149
30.3389	41	30.3493	44	30.4233	86	90.0107	149
30.3390	41	30.3494	44	30.4234	86	90.0108	149
30.3391	41	30.3495	44	30.4235	86	90.0109	149
30.3392	41	30.3496	44	30.4236	86	90.0110	149
30.3393	41	30.3497	44	30.4300	169	90.0111	149
30.3394	41	30.3498	44	30.4301	169	90.0112	149
30.3395	41	30.3499	44	30.4302	169	90.0113	149
30.3396	41	30.3500	44	30.4303	169	90.0114	149
30.3397	41	30.3501	44	30.4304	169	90.0117.000	149
30.3398	41	30.3502	44	30.4305	169	90.0117.001	149
30.3399	41	30.3504	45	30.4306	169	90.0117.002	149
30.3400	41	30.3505	45	30.4307	169	90.0118.000	149
30.3401	41	30.3510.000	80	30.4308	169	90.0118.001	149
30.3402	41	30.3510.115	80	30.4309	169	90.0118.002	149
30.3403	41	30.3510.130	80	30.4310	169	90.0119.000	149
30.3404	41	30.3510.145	80	30.4311	169	90.0119.001	149
30.3405	41	30.3510.160	80	30.4312	169	90.0119.002	149
30.3406	41	30.3510.180	80	30.4313	169	90.0122	149
30.3407	41	30.3510.200	80	30.4314	169	90.0123	149
30.3408	41	30.3511.115	80	30.4315	169	90.0124	149
30.3409	41	30.3511.130	80	30.4316	169	90.0125	149
30.3410	41	30.3511.145	80	30.4317	169	90.0126	149
30.3411	41	30.3511.160	80	30.4318	169	90.0127	149
30.3412	41	30.3511.180	80	30.4319	169	90.0128	149
30.3413	41	30.3591	46	30.4320	169	90.0129	150
30.3414	41	30.3592	46	30.4321	169	90.0130	150
30.3415	41	30.3593	46	30.4322	169	90.0131	150

Catalogue no. Nr katalogowy	Page Strona	Catalogue no. Nr katalogowy	Page Strona	Catalogue no. Nr katalogowy	Page Strona	Catalogue no. Nr katalogowy	Page Strona
90.0132	150	90.0269	154	90.0386	159	90.0485	162
90.0133	150	90.0270	154	90.0387	159	90.0486	162
90.0134	150	90.0271	154	90.0388	159	90.0487	162
90.0135	150	90.0272	154	90.0389	159	90.0488	162
90.0136	150	90.0273	154	90.0390	159		
90.0137	150	90.0274	154	90.0391	159		
90.0138	150	90.0275	154	90.0392	159		
90.0139	150	90.0276	154	90.0393	159		
90.0140	150	90.0277	154	90.0394	159		
90.0141	150	90.0278	154	90.0395	159		
90.0142	150	90.0279	154	90.0396	159		
90.0143	150	90.0280	154	90.0397	159		
90.0144	150	90.0281	154	90.0398	159		
90.0145	150	90.0282	154	90.0399	159		
90.0146	150	90.0283	154	90.0400	159		
90.0147	151	90.0294	155	90.0401	159		
90.0148	151	90.0295	155	90.0402	159		
90.0149	151	90.0296	155	90.0403	159		
90.0150	151	90.0297	155	90.0404	159		
90.0151	151	90.0298	155	90.0405	159		
90.0152	151	90.0299	155	90.0406	159		
90.0153	151	90.0300	155	90.0407	159		
90.0154	151	90.0301	155	90.0408	159		
90.0155	151	90.0302	155	90.0409	159		
90.0156	151	90.0303	155	90.0410	159		
90.0157	151	90.0304	155	90.0411	159		
90.0158	151	90.0305	155	90.0412	159		
90.0171	151	90.0306	155	90.0413	159		
90.0172	151	90.0316	156	90.0414	159		
90.0173	151	90.0317	156	90.0415	159		
90.0196	152	90.0318	156	90.0416	159		
90.0197	152	90.0334	157	90.0417	159		
90.0198	152	90.0335	157	90.0418	159		
90.0199	152	90.0336	157	90.0419	159		
90.0200	153	90.0337	157	90.0420	159		
90.0201	153	90.0338	157	90.0421	159		
90.0202	153	90.0339	157	90.0422	159		
90.0203	153	90.0340	157	90.0423	159		
90.0204	153	90.0341	157	90.0424	159		
90.0205	153	90.0342	157	90.0425	159		
90.0206	153	90.0343	157	90.0426	159		
90.0207	153	90.0344	157	90.0427	159		
90.0229	154	90.0345	157	90.0428	159		
90.0230	154	90.0346	157	90.0429	159		
90.0231	154	90.0348	158	90.0430	159		
90.0232	154	90.0349	158	90.0431	159		
90.0233	154	90.0350	158	90.0432	159		
90.0234	154	90.0351	158	90.0433	159		
90.0235	154	90.0352	158	90.0434	159		
90.0236	154	90.0353	158	90.0435	159		
90.0237	154	90.0354	158	90.0436	159		
90.0238	154	90.0355	158	90.0437	159		
90.0239	154	90.0356	158	90.0438	159		
90.0240	154	90.0357	158	90.0439	159		
90.0241	154	90.0358	158	90.0440	159		
90.0242	154	90.0359	158	90.0441	159		
90.0243	154	90.0360	158	90.0442	159		
90.0244	154	90.0361	158	90.0443	159		
90.0245	154	90.0362	158	90.0444	159		
90.0246	154	90.0363	158	90.0445	159		
90.0247	154	90.0364	158	90.0446	159		
90.0248	154	90.0365	158	90.0447	159		
90.0249	154	90.0366	158	90.0448	159		
90.0250	154	90.0367	158	90.0449	159		
90.0251	154	90.0368	158	90.0450	160		
90.0252	154	90.0369	158	90.0451	160		
90.0253	154	90.0370	158	90.0452	160		
90.0254	154	90.0371	158	90.0453	160		
90.0255	154	90.0372	158	90.0454	160		
90.0256	154	90.0373	158	90.0455	160		
90.0257	154	90.0374	158	90.0456	160		
90.0258	154	90.0375	158	90.0457	160		
90.0259	154	90.0376	158	90.0458	160		
90.0260	154	90.0377	158	90.0459	160		
90.0261	154	90.0378	159	90.0460	160		
90.0262	154	90.0379	159	90.0461	160		
90.0263	154	90.0380	159	90.0479	161		
90.0264	154	90.0381	159	90.0480	161		
90.0265	154	90.0382	159	90.0481	161		
90.0266	154	90.0383	159	90.0482	161		
90.0267	154	90.0384	159	90.0483	162		
90.0268	154	90.0385	159	90.0484	162		
						A	
						Adlerkreutz	42
						Adson	15, 39, 42, 48, 53, 88, 130, 131
						Adson-Baby	129
						Adson-Brown	42
						Adson-Tönnis	28
						Alexander	145
						Allis	68, 69, 70
						Allis-Adair	68
						Allis-Baby	68
						Alm	126
						Anderson-Adson	131
						B	
						Babcock	69, 70
						Baby-Adson	53
						Baby-Collin	135
						Baby-Crile	49
						Baby-Lexer	24
						Baby-Olsen-Hegar	14, 20
						Baby-Roux	100
						Baby-Satinsky	76
						Baby-Senn-Miller	99
						Backhaus	63
						Bakes	81
						Balfour	140, 141
						Balfour-Baby	140
						Barsky	90
						Baumgartner	20
						Beckmann	130
						Beckmann-Adson	132
						Beckmann-Eaton	132
						Bengolea	54
						Benson	69
						Berger	145
						Bergmann	93
						Best	84
						Bevan	84
						Blake	83
						Blount	112
						Bonney	43
						Bose	88
						Bottcher	30
						Boys-Allis	68
						Bozemann	18, 66
						Bozemann-Douglas	66
						Braun-Stadler	27
						Breisky	150
						Brophy	40, 42
						Brown	13, 77
						Brunner	9, 116, 117
						Bruns	33
						Bumm	157
						Busch	27
						C	
						Caspar	108
						Castroviejo	20
						Cheron	65
						Chir. Pinzette	48
						Collier	13
						Collin	65, 74, 86, 102, 135, 151
						Collin- Hartmann	100
						Collin-lokrite	134
						Cone	128
						Coolley	122
						Coryllos	121
						Crafoord	32, 57
						Crafoord-Sellers	58
						Crile	15, 50, 89, 95
						Crile-Rankin	50

Catalogue no. Nr katalogowy	Page Strona	Catalogue no. Nr katalogowy	Page Strona	Catalogue no. Nr katalogowy	Page Strona	Catalogue no. Nr katalogowy	Page Strona
Crile-Wood	12, 15, 19	Heaney	15, 20, 61	M		Potts-Smith	28, 29, 39, 43, 48
Cushing	40, 42, 48, 89, 94, 96	Heaney-Ballentine	61	Magill	85	Pratt	85
Czerny	77	Hegar	18, 154, 155	Magill-Baby	85	Presbyterian	65
D		Hegar-Baum	16	Maier	65	Price-Thomas	74
Dandy	28, 52, 87	Heiss	53	Markham-Meyerding	137	Prince	30
Darmschere	32	Holtzheimer	126	Martin	115, 156	Providence Hospital	52
Davidson	122	Holzbach	133	Masson	15, 20		
Davis	67	Hösel	109	Mathieu	16, 19, 102	R	
Dean	30	I		Mayo	22, 35, 37, 81	Ragnell-Davis	99
Deaver	23, 118, 119	Iris	38	Mayo-Blake	83	Ramplery	67
De Bakey	44	Irisschere	35	Mayo-Guyon	61	Randall	82
De Bakey	18, 29, 79	Israel	104	Mayo-Harrington	24	Recamier	159
DeBakey	136	Iterson	93	Mayo-Hegar	12, 17	Reverdin	11, 124
Derf	13, 20	J		Mayo-Lexer	24, 35, 37	Reynolds	28
Derra	75	Jackson	91, 93	Mayo-Noble	24	Ricard	133
Desjardins	60, 81, 82	Jacobs	78	Mayo-Robson	70, 73	Richardson	107, 112
Desmarres	95	Jaeger	91	Mayo-Russian	43	Richardson-Eastman	108
Diethrich-Hogemann	29	Jameson	16	Mayo-Stille	22, 35, 37	Richter	23
Dietrich	29	Jansen	126	McGivney	85	Rigby	137
Douglas	46	Johns Hopkins	59	Mc Indoe	30, 39	Roberts	54
Doyen	23, 63, 70, 72, 113, 150, 151, 161	Jones	64	Meekers	56	Rochester	84
Doyen-Stille	113	Joseph	25, 90	Metzenbaum	21, 34, 37	Rochester-Carmalt	52
Dubois	27	Judd-Allis	68	Metzenbaum Fino	38	Roeder	63
Duplay	65, 78	K		Metzenbaum-Fino	34	Rogers	71
Duval	70, 74	K2-660	167	Metzenbaum-Lahey	25	Rogge	67
E		K2-740	167	Metzenbaum (Strabismus)	25	Rose	95
Eppendorfer	144	Kallmorgen	149	Metzenbaum Strabismus	38	Roux	100
Ermold	16	Kantrowitz	56	Meyerding	93, 123, 137	Rumel	57
Esmarch	33	Kelly	25, 52, 107, 112, 120, 161	M.G.H	13	Russian	43
F		Kelly-Rankin	52	Michel	86		
Farabeuf	102	Kevorkian	144	Middeldorpf	111	S	
Faure	60, 147	Kilner	25, 89	Mikulicz	61, 120	Sachs	87
Ferris-Smith	48	Klapp	95	Milligan	129	Sarot	13, 20, 58
Finocchio	15, 18	Kleinert-Kutz	90	Mini-Gemini	55	Satinsky	76
Finsen	126	Knowles	32	Mini-Langenbeck	91	Satynsky	28
Fisch	87	Kocher	10, 51, 73, 97, 98, 106, 107, 114	Mini-Roux	100	Sauerbruch	106, 121
Foerster	66	Kocher-Langenbeck	106	Mini-Tischler	148	Scalp Contour	128
Frazier	89, 139	Kocher (Ochsner)	51	Mixer	23, 58, 59, 83	Schmieden	9, 30
French	17	Kocher-Wagner	108	Mixer-Baby	58	Schmieden-Payr	9
French- Mathieu	19	Kogan	153	Mixer-O'Shaugnessy	58	Schoenborn	88
Fritsch	113	König	10, 95	Modell Tübingen	115	Schröder	77
G		Körte	103, 104	Mod. USA	27	Schröder-Brown	77
Gellhorn	147	Körte-Wagner	104	Mollison	129	Schroeder	160
Gelpi-Loktite	136	Krayenbühl	87	Morris	110	Schubert	146
Gemini	55	Kristeller	149	Moynihan	62	Schumacher	27, 144, 146
Gerald	40, 41	Kuehne	46	Museum	78	Semken	39, 42
Gillies	14, 18, 41, 89	Kuempel	125	N		Semm	150
Gillies-Baby	18	L		Nabatoff	79	Senn-Green	99
Gil-Vernet	94	Laborde	75	Negus	59	Senn-Miller	99
Golet	100	La Grange	38	Nelson	43	Seutiny	33
Goldmann-Fox	24, 36	Lahey	59, 106	News	88	Siebold	26
Gosset	138	Lane	43, 63	Nota	161	Simon	114, 160
Graefe	91	Langenbeck	105	O		Sims	26, 36, 150, 156, 158
Graham	88	Langenbeck-Green	99	O'Connor	91	Singley-Tut	43
Gray	60	Lateral Retraktor	152	Ollier	103	Sistrunk	31
Grazil	22	Laufe	85	Olsen-Hegar	14, 18	Skene	78
Green	56	Leriche	49	Olsen- Mathieu	19	Smith	32
Gross	64	Lewkowitz	84	Ombredanne	64	Smithwick	87
Guthrie	91	Ligaturschere	31	Overholt	56	Spencer	31
H		Lister	33, 35, 38, 62	Overholt-Geissendoerfer	57	Spencer-Wells	53
Haberer	124	Littauer	31, 46	P		Standard	21, 34, 39, 41
Hagenbarth	86	Little	94	Parametrium	36	Standard mod. USA	39
Halsey	12, 17	Lockwood-Allis	68	Parker	101	Staude-Moore	77
Halsted-Mosquito	49, 50	Lorenz	32	Parker-Langenbeck (US-Army)	101	Stevens	38
Harken	75	Lorna	63	Parker-Mott	101	Stille	56
Harrington	119	Lovelace	52, 74	Payr	10, 69	St. Marks	110
Harrington-Pemberton	119	Love (Morse)	94	Pean	50, 51	Strabismus (Metzenbaum)	35
Hartmann	49	Lower	59	Pean (Rochester)	51	Strandell-Stille	96
		Lucae	45	Pears	64	Stratte	12, 18
		Luer	95	Pelkmann	67	Strully	28
		Lukens	91	Pennington	53, 67	T	
				Phaneuf	60	Taylor	42
				Plester	128	Taylor	40
						Teale	77
						Temple-Fay	139
						Thomas	65, 158

Catalogue no. Nr katalogowy	Page Strona	Catalogue no. Nr katalogowy	Page Strona	Catalogue no. Nr katalogowy	Page Strona	Catalogue no. Nr katalogowy	Page Strona
Thoms-Allis	68						
Thoms-Gaylor	147						
Tischler	146, 148						
Tischler-Kevorkian	148						
Tischler-Morgan	148						
Toennis	87						
Tönnis	28						
Tönnis-Adson	34						
Trousseau	75						
Tübinger Modell	129						
Tuffier	113, 124						
 U							
Ulrich	64						
 V							
Van Doren	147						
Volkman	93, 96, 97, 98						
 W							
Wachenfeldt	86						
Waldmann	27						
Wangensteen	15, 48						
Wassmund	104						
Waugh	40, 42						
Webster	12, 17						
Weitlaner-Baby	127						
Weitlaner-Lokite	127						
Weitlaner-Wullstein	127						
Wertheim	26, 61, 62						
Wertheim-Cullen	62						
Wiener	91						
Williams	69						
Winter	162						
Wittner	145						
 Y							
Young	84						
 Z							
Zenker	54, 115						

ChM sp. z o.o.
Lewickie 3b
16-061 Juchnowiec Kościelny
Poland
tel. +48 85 86 86 100
fax +48 85 86 86 101
chm@chm.eu
www.chm.eu

