

СНМ®

NARZĘDZIA ORTOPEDYCZNE
ORTHOPAEDIC INSTRUMENTS
ОРТОПЕДИЧЕСКИЕ ИНСТРУМЕНТЫ



NARZĘDZIA ORTOPEDYCZNE
ORTHOPAEDIC INSTRUMENTS
ОРТОПЕДИЧЕСКИЕ ИНСТРУМЕНТЫ

40 lat

doświadczenia

Historia marki sięga roku 1981, kiedy przez Mikołaja Charkiewicza zostaje powołana do życia firma ChM. W roku 1985 rozpoczęto prace związane z produkcją prostych narzędzi chirurgicznych, a rok później, w 1986 r., powołano biuro projektowe, którego zadaniem było opracowywanie konstrukcji i technologii wytwarzania wyrobów stosowanych w ortopedii i traumatologii. Choć dostępna w tym czasie w Polsce wiedza na temat materiałów, technologii czy funkcjonowania narzędzi medycznych była bardzo ograniczona, już na początku lat 90-tych firma rozpoczęła produkcję pierwszych prostych implantów metalowych. W roku 2004 firma przekształciła się w jednostkę z osobowością prawną pod nazwą ChM spółka z ograniczoną odpowiedzialnością.

Obecny sukces firmy zawdzięczamy początkowym ograniczeniom. To one stały się przyczynkiem do ciągłych poszukiwań, samokształcenia oraz tworzenia własnej bazy badawczej. Dzisiejsza współpraca obejmuje zarówno środowisko medyczne jak i instytucje badawcze w kraju i zagranicą. 40 lat doświadczeń nauczyło nas słuchać i reagować na potrzeby dynamicznie rozwijającej się medycyny. Cały ten okres to rozwój oparty na relacjach wzajemnego zaufania. To właśnie dzięki nim możemy rozbudowywać portfolio naszych produktów.

Oferowane przez nas narzędzia to najwyższej jakości wyroby medyczne, wytwarzane zgodnie z obowiązującą wersją norm EN ISO 9001:2015 oraz EN ISO 13485:2016 i zgodne z Dyrektywą 93/42/EEC dotyczącą produktów medycznych.

Narzędzia są w specjalny sposób oznakowane kodem DATAMATRIX. Zapewnia to:

- monitorowanie miejsca znajdowania się danego narzędzia
- śledzenie narzędzia na drodze szpital-sterylizatornia
- zawarcie pełnej informacji o wyrobie na małej powierzchni
- oszczędność czasu przy organizacji pracy szpitala.

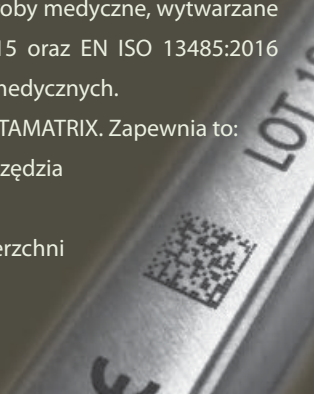

40 years of experience

The history of the brand dates back to 1981, when Mr. Mikołaj Charkiewicz established the ChM company. In 1985 the production of first simple surgical instruments had started and a year after, in 1986, the design department was created. Its main task was to develop the design and manufacture technology of products used in orthopedics and traumatology. Although the available knowledge about materials, technology or functioning of medical tools was limited back then in Poland, the production of first simple metal implants was started in the beginning of the 1990s. In 2004, the company transformed into the ChM limited liability company.

We owe this success of the company to the initial limitations. These limitations contributed to constant search, self-education and creation of own research base. Today's cooperation incorporates both medical environment and research institutions in the country and abroad. 40 years of experience has taught us to listen and respond to the needs of dynamically developing medicine. This whole period was a time of development based on mutual trust. Thanks to this kind of relationship we are able to expend our product portfolio by creating a new solution.

The instruments we offer are medical devices of the highest quality manufactured in accordance with the applicable version of EN ISO 9001:2015 and EN ISO 13485:2016 and in accordance with Directive 93/42/EEC concerning medical products. Our instruments are marked in a special way with DATAMATRIX code. The code provides:

- monitoring of a particular instrument's location
- tracking an instrument on the hospital - sterilization path
- providing full information about a product on a small area
- saving time in the organization of hospital work.

40 лет опыта

История бренда берёт своё начало в 1981 году, когда Миколай Харкевич основал компанию ChM. В 1985 году было налажено производство простых хирургических инструментов, а уже год спустя, в 1986 году, было создано конструкторское бюро, задачей которого стала разработка конструкции и технологии производства изделий, используемых в ортопедии и травматологии. Несмотря на то что доступные на то время в Польше знания на тему материалов, технологии и функционирования медицинских инструментов были сильно ограничены, уже в начале 90-ых годов компания начала производство первых простых имплантатов из металла. В 2004 году компания была преобразована в организацию с правосубъектностью под названием ChM общество с ограниченной ответственностью.

Нынешнему успеху компании мы обязаны начальным ограничениям. Это они стали причиной непрерывного поиска, саморазвития и создания собственной исследовательской базы. Сегодня сотрудничество охватывает как медицинское общество, так и исследовательские учреждения в Польше и за рубежом. 40-а летний опыт научил нас слушать и реагировать на нужды динамично развивающейся медицины. Весь этот промежуток времени – это развитие, основанное на отношениях взаимного доверия. Это благодаря им мы можем расширять ассортимент наших продуктов.

Предлагаемые нами инструменты – это медицинские изделия высочайшего качества, изготовленные в соответствии с действующей версией стандартов EN ISO 9001:2015 и EN ISO 13485:2016 и в соответствии с Директивой 93/42/EEC о медицинских изделиях. Наши инструменты особым образом маркированы кодом DATAMATRIX. Это обеспечивает:

- мониторинг местонахождения данного инструмента
- отслеживание инструмента на пути больница – стерилизация
- полную информацию об изделии на небольшой поверхности
- экономию времени при организации работы больницы.

NARZĘDZIA DO AMPUTACJI 7 AMPUTATION INSTRUMENTS ИНСТРУМЕНТЫ ДЛЯ АМПУТАЦИИ	RĄCZKA STEINMANNA/ GWINTOWNIKI/ INNE 69 STEINMANN HANDLE/ TAPS/ OTHERS РУЧКА ШТЕЙНМАННА/ МЕТЧИКИ/ ДРУГОЕ
NOŻE AMPUTACYJNE, KOSTNE 9 AMPUTATING, RESECTION KNIVES АМПУТАЦИОННЫЕ НОЖИ, КОСТНЫЕ	ROZWIERTAKI ŚRÓDSZPIKOWE 70 INTRAMEDULLARY REAMERS ИНТРАМЕДУЛЛЯРНЫЕ СВЕРЛА
PILNIKI KOSTNE 10 BONE FILES НАПИЛЬНИКИ	NARZĘDZIA DO GIĘCIA PŁYTEK 73 BENDING INSTRUMENTS FOR PLATES ГИБОЧНЫЕ КЛЕЩИ ДЛЯ ПЛАСТИН
POBIJAKI 11 TAMPERS ПРОБОЙНИКИ	NARZĘDZIA DO CHIRURGII RĘKI/ HAKI 74 HAND SURGERY INSTRUMENTS/ RETRACTORS ХИРУРГИЧЕСКИЕ ИНСТРУМЕНТЫ ДЛЯ РУКИ/ РАНОРАСШИРИТЕЛИ
DŁUTA, OSTEOTOMY, DŁUTA ŻŁOBOWE 12 CHISELS, OSTEOTOMES, GOUGES ДОЛОТА, ОСТЕОТОМЫ, ЖЕЛОБОВАТЫЕ ДОЛОТА	NARZĘDZIA DO CHIRURGII RĘKI/ PODWAŻKI 76 HAND SURGERY INSTRUMENTS/ ELEVATORS ХИРУРГИЧЕСКИЕ ИНСТРУМЕНТЫ ДЛЯ РУКИ/ ЭЛЕВАТОРЫ
OSTEOTOMY DO CHIRURGII PLASTYCZNEJ 19 OSTEOTOMES FOR PLASTIC SURGERY ОСТЕОТОМЫ ДЛЯ ПЛАСТИЧЕСКОЙ ХИРУРГИИ	NARZĘDZIA DO CHIRURGII RĘKI/ DŁUTA, OSTEOTOMY 77 HAND SURGERY INSTRUMENTS/ CHISELS, OSTEOTOMES ХИРУРГИЧЕСКИЕ ИНСТРУМЕНТЫ ДЛЯ РУКИ/ ДОЛОТА, ОСТЕОТОМЫ
ŁYŻECZKI KOSTNE 20 BONE CURETTES КОСТНЫЕ ЛОЖКИ	ROZWIERACZE 79 SPREADERS РАСШИРИТЕЛИ
MŁOTKI 23 HAMMERS МОЛОТКИ	DYSTRAKTORY 81 DISTRACTORS ДИСТРАКТОРЫ
SKROBACZKI 24 RASPATORIES РАСПАТОРЫ	NARZĘDZIA DO ENDOPROTEZ 82 INSTRUMENTS FOR ENDOPROSTHESIS ИНСТРУМЕНТЫ ДЛЯ ПРОТЕЗИРОВАНИЯ
PODWAŻKI ZDERKIEWICZA 28 ZDERKIEWICZ ELEVATORS ЭЛЕВАТОРЫ ЗДЕРККЕВИЧА	ODGRYZACZE DO KRĄŻKÓW MIĘDZYKRĘGOWYCH 83 INTERVERTEBRAL DISC RONGEURS КУСАЧКИ ДЛЯ МЕЖПОЗВОНОЧНЫХ БЛОКОВ
PODWAŻKI 29 ELEVATORS ЭЛЕВАТОРЫ	ODGRYZACZE DO NEUROCHIRURGII I LAMINEKTOMII 87 NEUROSURGERY AND LAMINECTOMY RONGEURS КУСАЧКИ ДЛЯ НЕЙРОХИРУРГИИ
ODGRYZACZE KOSTNE 34 BONE RONGEURS FORCEPS КОСТНЫЕ КУСАЧКИ	ROZWIERACZE DO KRĘGOSŁUPA 89 LAMINA SPREADERS РАСПРОСТРАНТЕЛИ ДЛЯ ПОЗВОНОЧНИКА
KLESZCZE DO CIĘCIA KOŚCI 41 BONE CUTTING FORCEPS КЛЕЩИ ДЛЯ РЕЗКИ КОСТИ	KLESZCZE DO ŻEBER 90 RIB SHEARS КЛЕЩИ ДЛЯ РЕБЕР
USTALACZE ODŁAMÓW KOŚCI 43 BONE HOLDING FORCEPS КОСТОДЕРЖАТЕЛИ	ALUMINIOWE ROZWIERACZE DO ŻEBER 92 RIB SPREADERS FROM ALUMINIUM АЛЮМИНИЕВЫЕ РАСШИРИТЕЛИ ДЛЯ РЕБЕР
KLAMRY DO WYCIĄGU CZASZKOWEGO 49 SKULL TRACTION TONGS СКОБЫ ДЛЯ ВЫТЯЖЕНИЯ ЗА ЧЕРЕП	ROZWIERACZE DO ŻEBER 95 RIB SPREADERS РАСШИРИТЕЛИ ДЛЯ РЕБЕР
KLAMRY DO WYCIĄGU 51 TRACTION BOWS СКОБЫ ДЛЯ ВЫТЯЖЕНИЯ	ZWIERACZE DO ŻEBER 99 RIB CONTRACTORS ЗАЖИМЫ РЕБЕРНЫЕ
KLAMRA MOLSKIEGO 52 MOLSKI'S CLASP СКОБА МОЛЬСКОГО	OPASKI 100 CUFFS ПНЕВМОМАНЖЕТЫ
UCHWYTY DO MOCOWANIA DŁONI 53 HAND FIXATIONS ДЕРЖАТЕЛИ ДЛЯ РУКИ	ZASILACZE 101 TOURNIQUETS ПНЕВМОДОЗАТОРЫ
NARZĘDZIA DO OPATRUNKÓW I GIPSU 54 BANDAGE AND PLASTER REMOVING INSTRUMENTS ИНСТРУМЕНТЫ ДЛЯ УДАЛЕНИЯ ГИПСА И ПЕРЕВЯЗОЧНЫХ МАТЕРИАЛОВ	PODWÓJNY ELEKTRONICZNY ZASILACZ OPASEK ZACISKOWYCH TYP EZO-02 103 EZO-02 ELECTRONIC DUAL TOURNIQUET CONTROL UNIT ДВОЙНОЙ ЭЛЕКТРОННЫЙ ПНЕВМОДОЗАТОР ДЛЯ ПНЕВМОМАНЖЕТ ТИП EZO-02
NARZĘDZIA DO DRUTU 60 WIRE INSTRUMENTS ИНСТРУМЕНТЫ ДЛЯ ПРОВОЛОКИ	WYPOSAŻENIE ZASILACZY 104 TOURNIQUETS EQUIPMENT СНАРЯЖЕНИЕ ПНЕВМОДОЗАТОРОВ
KLESZCZE DO GIĘCIA DRUTU 61 WIRE PLIERS КЛЕЩИ ДЛЯ ПРОВОЛОКИ	WZORCE DŁUGOŚCI 105 LENGTH MEASURING GAUGES ОБРАЗЦЫ ДЛИНЫ
KLESZCZE DO GIĘCIA I CIĘCIA DRUTU 63 WIRE PLIERS КЛЕЩИ ДЛЯ ПРОВОЛОКИ	
KLESZCZE DO CIĘCIA DRUTU I GWOŹDZI 64 WIRE AND NAIL CUTTING FORCEPS КЛЕЩИ ДЛЯ ПРОВОЛОКИ И СТЕРЖНЕЙ	
WIERTŁA 68 DRILLS СВЕРЛА	



Retraktor Percy
Retractor Percy
Ретрактор Персы
40.0413



Piła amputacyjna
Amputation saw
Ампутационная пила

długość ostrza
length of blade
длина лезвия

40.0231 220 mm



Charriere

40.3352 350 mm

komplet z ostrzami wymiennymi
set with interchangeable blades
в состав комплекта
входят лезвия

40.3353 12/215 mm

40.3354 18/215 mm



Langenbeck

40.3355 235 mm

długość ostrza
length of blade
длина лезвия
115 mm



Olivecrona

40.3190 300 mm
 40.3191 400 mm
 40.3192 500 mm
 40.3193 700 mm
 ø 1,2 mm



Gigli

40.0432
 Uchwyt
 Saw Handle
 Ручка



Martel

40.4575
 330 mm
 Prowadnica
 Conductor
 Ручка



Gigli

	5 Szt. 5 Pcs 5 Шт.	1 Szt. 1 Pcs 1 Шт.
300 mm	40.3356.005	40.3356
400 mm	40.3357.005	40.3357
500 mm	40.3358.005	40.3358
ø 1,4 mm		
500 mm	40.3359.005	40.3359
ø 1,8 mm		



Nóż Virchowa

30.3513.000
 200 mm

długość ostrza
 length of blade
 длина лезвия

85 mm



Nóż Virchowa

30.3513.100
 200 mm

długość ostrza
 length of blade
 длина лезвия

95 mm



Nóż Virchowa

30.3513.200
 200 mm

długość ostrza
 length of blade
 длина лезвия

115 mm

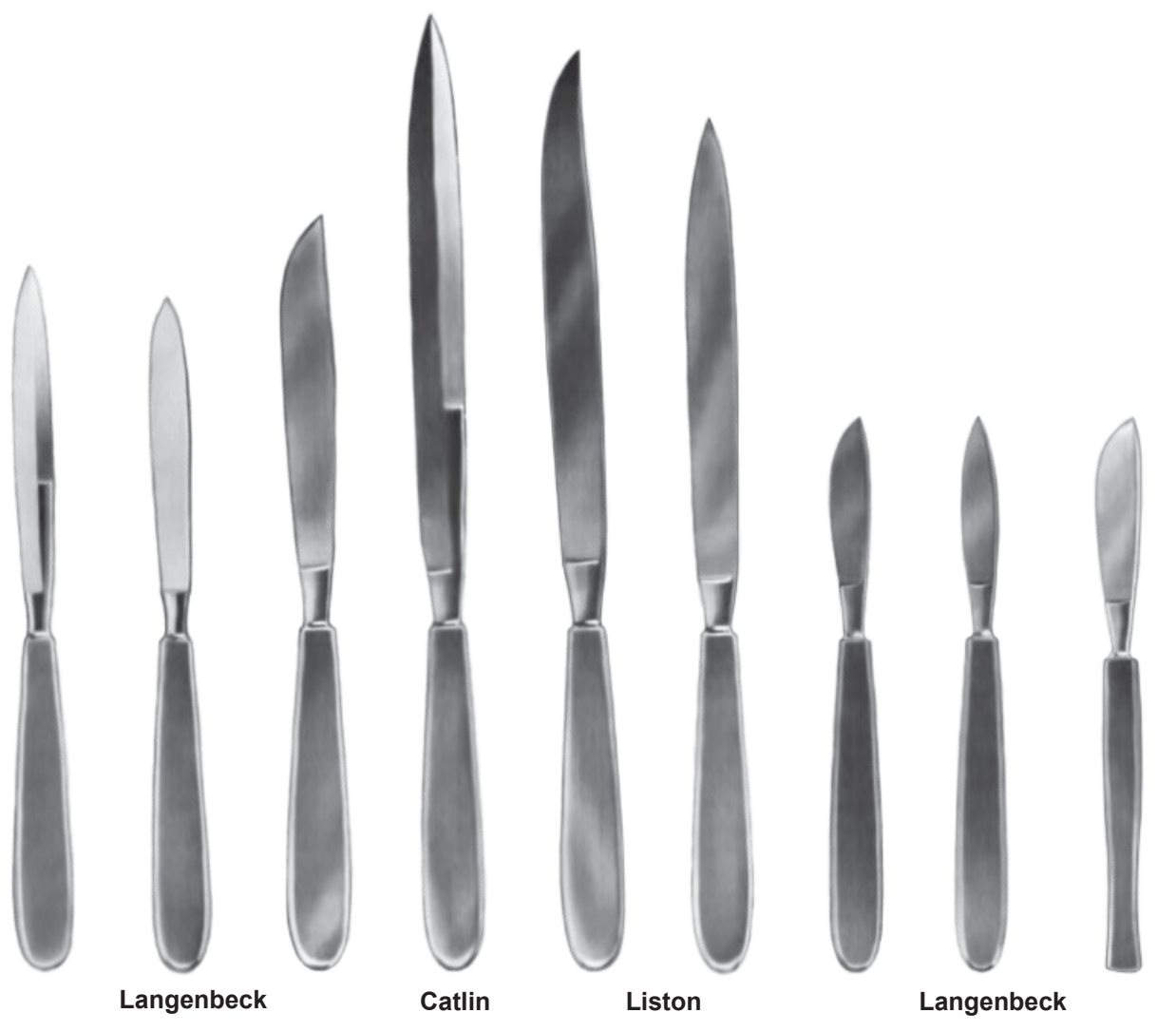

długość ostrza
 length of blade
 длина лезвия

55 mm				40.0121	40.0122
65 mm					40.0290
95 mm	30.2945				
110 mm	30.0028				
120 mm		30.0034			
130 mm		30.2946		30.0029	
160 mm			30.0030	30.0031	
170 mm				30.2947	
190 mm			30.2940	30.0032	
200 mm				30.2949	
220 mm			30.2944	30.0033	

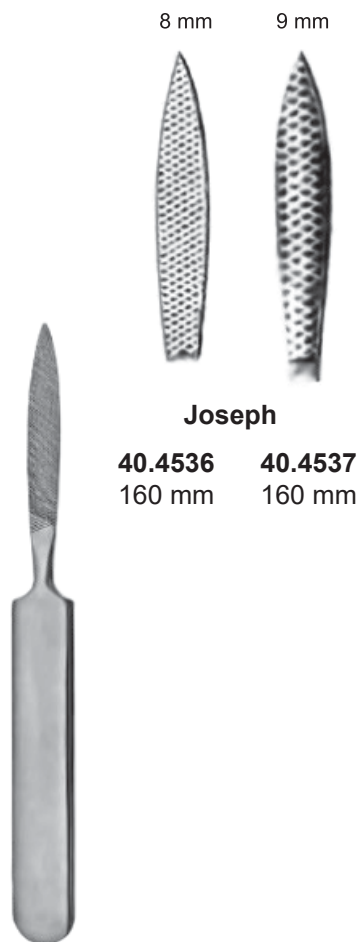
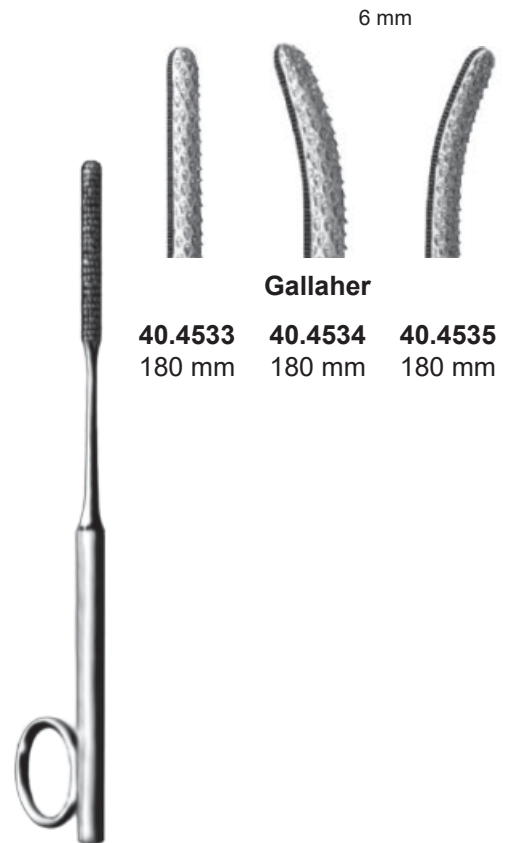
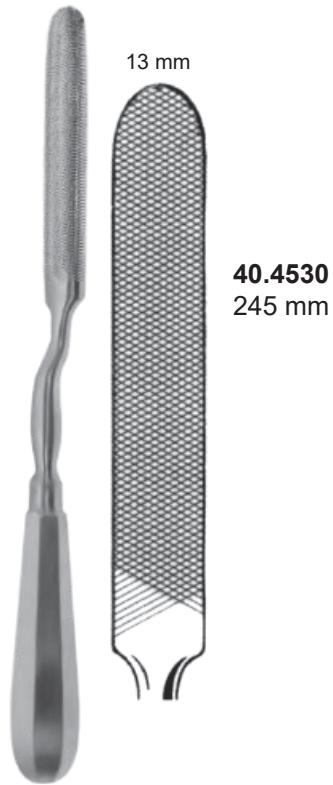



Passow

40.0493.025 2,5 mm
120 mm



Passow

40.0493.035 3,5 mm
120 mm



40.0494.002 2 mm
40.0494.003 3 mm
40.0494.004 4 mm
40.0494.005 5 mm
40.0494.006 6 mm
40.0494.008 8 mm
40.0494.010 10 mm
160 mm



Caspar

40.0495.003 3 mm
40.0495.005 5 mm
40.0495.008 8 mm
40.0495.012 12 mm
40.0495.014 14 mm
40.0495.016 16 mm
200 mm



Caspar

40.0495.103 3 mm
40.0495.105 5 mm
40.0495.108 8 mm
40.0495.112 12 mm
40.0495.114 14 mm
40.0495.116 16 mm
200 mm



uchwyt z tworzywa
plastic handle
пластиковая рукоятка



Lambotte

- 40.0210 4 mm
- 40.0211 8 mm
- 40.0212 10 mm
- 40.0213 13 mm
- 40.0214 16 mm
- 40.0215 18 mm
- 40.0216 20 mm
- 40.0217 25 mm
- 40.0218 30 mm
- 40.0219 38 mm
- 40.0220 44 mm
- 40.0221 50 mm
- 250 mm



- 40.0523 8 mm
- 40.0524 13 mm
- 40.0525 18 mm
- 40.0526 25 mm
- 40.0527 30 mm
- 40.0528 38 mm
- 250 mm



Lambotte - mini

- 40.0222 4 mm
- 40.0223 6 mm
- 40.0224 8 mm
- 40.0226 10 mm
- 40.0227 12 mm
- 40.0228 15 mm
- 125 mm



- 40.0039 4 mm
- 40.0046 6 mm
- 40.0047 8 mm
- 40.0048 10 mm
- 40.0049 12 mm
- 140 mm



- 40.0029 4 mm
- 40.0056 6 mm
- 40.0057 8 mm
- 40.0058 10 mm
- 40.0059 12 mm
- 140 mm



Championniere

- 40.0020 40 mm
- 180 mm



Mannerfelt modyf.

- 40.0262 4 mm
- 40.0263 6 mm
- 40.0264 8 mm
- 155 mm



Mannerfelt modyf.

- 40.0072
- 155 mm





Lexer

40.0194 5 mm
40.0195 10 mm
40.0196 15 mm
250 mm



Lexer

40.0197 5 mm
40.0198 10 mm
40.0199 15 mm
250 mm



Lexer

40.0271 5 mm
40.0272 7 mm
40.0273 10 mm
40.0274 15 mm
40.0276 20 mm
40.0277 25 mm
40.0278 30 mm
220 mm



Lexer - mini

40.0266 4 mm
40.0267 6 mm
40.0268 8 mm
40.0269 10 mm
40.0270 12 mm
190 mm



Lexer

40.0296 10 mm
40.0297 15 mm



40.0291 10 mm
40.0292 15 mm
275 mm

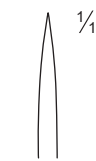
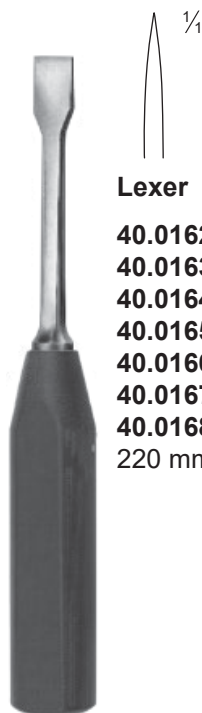

Lexer

40.0162 5 mm
40.0163 7 mm
40.0164 10 mm
40.0165 15 mm
40.0166 20 mm
40.0167 25 mm
40.0168 30 mm
220 mm



Lexer - mini

40.0125 4 mm
40.0126 6 mm
40.0127 8 mm
40.0128 10 mm
40.0129 12 mm
180 mm



Dłuto proste

Gouge straight
Долото прямое
40.7230.005 5 mm
40.7230.010 10 mm
40.7230.015 15 mm
265 mm

Dłuto odgięte

Gouge curved
Долото изогнутое
40.7231.005 5 mm
40.7231.010 10 mm
40.7231.015 15 mm
265 mm



Wagner
340 mm



40.0485.009 9 mm
40.0485.015 15 mm
40.0485.030 30 mm



40.0486.009 9 mm
40.0486.015 15 mm
40.0486.030 30 mm



40.0487.009 9 mm
40.0487.015 15 mm
40.0487.030 30 mm



Dahmen
300 mm



40.0488.004 4 mm
40.0488.006 6 mm
40.0488.008 8 mm
40.0488.010 10 mm
40.0488.015 15 mm
40.0488.020 20 mm
40.0488.025 25 mm



40.0489.004 4 mm
40.0489.006 6 mm
40.0489.008 8 mm
40.0489.010 10 mm
40.0489.015 15 mm
40.0489.020 20 mm
40.0489.025 25 mm



Dahmen
300 mm



40.0490.004 4 mm
40.0490.006 6 mm
40.0490.008 8 mm
40.0490.010 10 mm
40.0490.015 15 mm
40.0490.020 20 mm
40.0490.025 25 mm



40.0491.004 4 mm
40.0491.006 6 mm
40.0491.008 8 mm
40.0491.010 10 mm
40.0491.015 15 mm
40.0491.020 20 mm
40.0491.025 25 mm



Cobb
270 mm



40.0492.100 8 mm



40.0492.200 8 mm



40.0492.300 8 mm



40.0492.400 8 mm

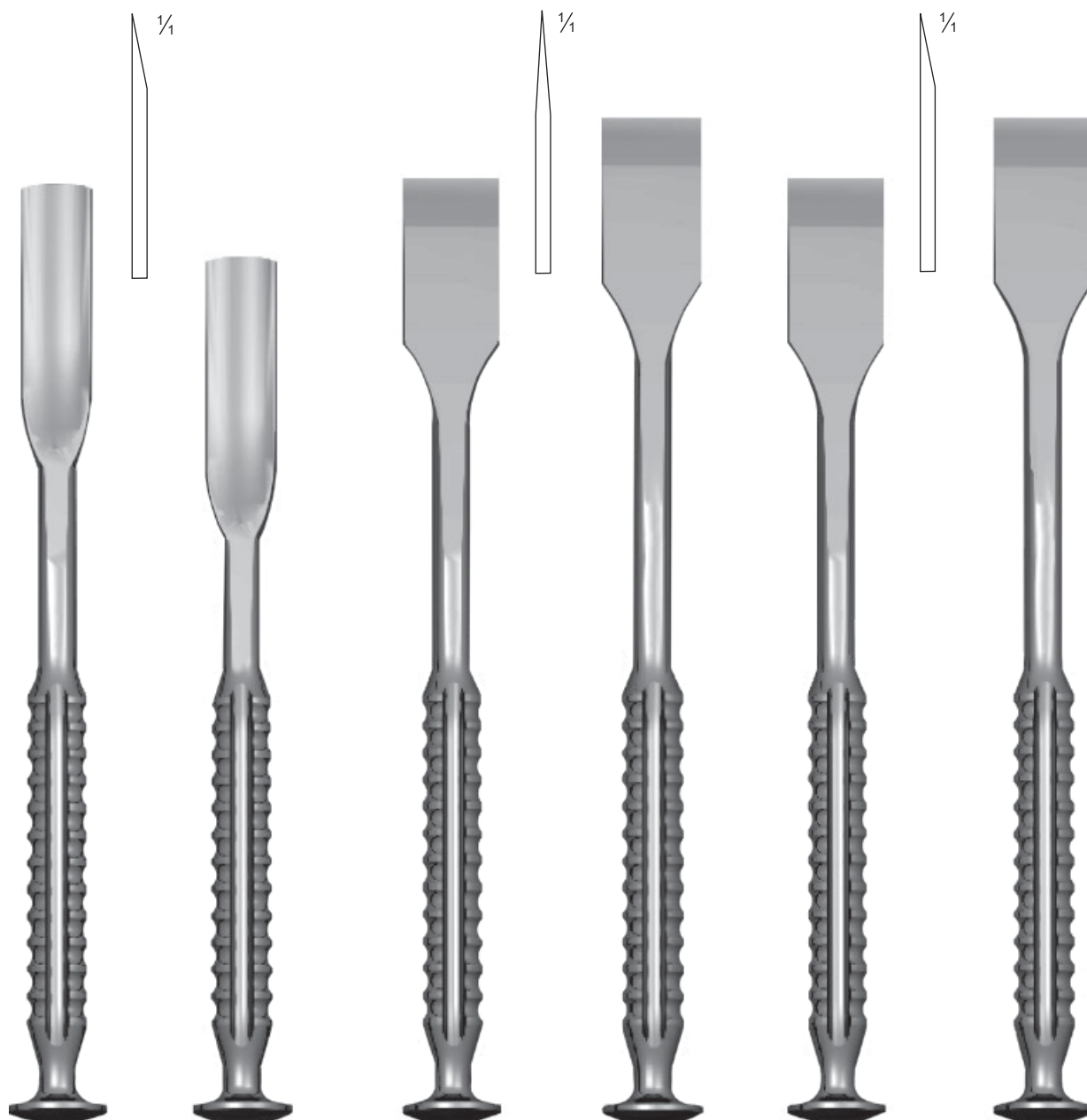

ChM

40.0080 10 mm
40.0082 15 mm
40.0084 20 mm
40.0086 25 mm
40.0088 30 mm
 280 mm

ChM

40.0081 10 mm
40.0083 15 mm
40.0085 20 mm
40.0087 25 mm
40.0089 30 mm
 240 mm

ChM

40.0051 10 mm
40.0304 12 mm
40.0305 15 mm
40.0053 20 mm
40.0306 25 mm
40.0055 30 mm
 240 mm

ChM

40.0050 10 mm
40.0301 12 mm
40.0302 15 mm
40.0052 20 mm
40.0303 25 mm
40.0054 30 mm
 280 mm

ChM

40.0061 6 mm
40.0063 10 mm
40.0308 12 mm
40.0065 15 mm
40.0067 20 mm
40.0069 25 mm
40.0071 30 mm
 240 mm

ChM

40.0060 6 mm
40.0062 10 mm
40.0307 12 mm
40.0064 15 mm
40.0066 20 mm
40.0068 25 mm
40.0070 30 mm
 280 mm



Stille

- 40.0040** 6 mm
- 40.0041** 10 mm
- 40.0034** 12 mm
- 40.0042** 15 mm
- 40.0043** 20 mm
- 40.0044** 25 mm
- 40.0045** 30 mm
- 200 mm



Stille

- 40.0155** 10 mm
- 40.0156** 12 mm
- 40.0157** 15 mm
- 40.0158** 20 mm
- 40.0159** 25 mm
- 200 mm

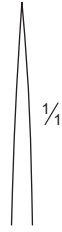

Mac Evan - Stille

- 40.0023** 6 mm
- 40.0010** 10 mm
- 40.0013** 12 mm
- 40.0014** 15 mm
- 40.0011** 20 mm
- 40.0017** 25 mm
- 40.0012** 30 mm
- 40.0022** 40 mm
- 200 mm



Stille

- 40.0245** 10 mm
- 40.0246** 12 mm
- 40.0247** 15 mm
- 40.0248** 20 mm
- 40.0249** 25 mm
- 200 mm



Stille

- 40.0510** 6 mm
- 40.0511** 8 mm
- 40.0512** 10 mm
- 40.0513** 12 mm
- 40.0514** 15 mm
- 160 mm



Hibbs

- 30.4028** 6 mm
- 30.4029** 13 mm
- 30.4030** 19 mm
- 30.4031** 25 mm
- 30.4032** 32 mm
- 240 mm



Hibbs

- 30.4033** 6 mm
- 30.4034** 13 mm
- 30.4035** 19 mm
- 30.4036** 25 mm
- 30.4037** 32 mm
- 240 mm



Hibbs

- 30.4038** 6 mm
- 30.4039** 13 mm
- 30.4040** 19 mm
- 30.4041** 25 mm
- 30.4042** 32 mm
- 240 mm



Hibbs

- 30.4043** 6 mm
- 30.4044** 13 mm
- 30.4045** 19 mm
- 30.4046** 25 mm
- 30.4047** 32 mm
- 240 mm



Hibbs

- 30.4048** 6 mm
- 30.4049** 13 mm
- 30.4050** 19 mm
- 30.4051** 25 mm
- 30.4052** 32 mm
- 240 mm

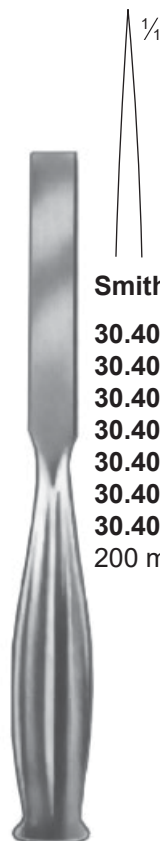

Smith - Petersen

- 30.4000** 6 mm
- 30.4001** 9 mm
- 30.4002** 13 mm
- 30.4003** 16 mm
- 30.4004** 19 mm
- 30.4005** 25 mm
- 30.4006** 32 mm
- 200 mm



Smith - Petersen

- 30.4007** 6 mm
- 30.4008** 9 mm
- 30.4009** 13 mm
- 30.4010** 16 mm
- 30.4011** 19 mm
- 30.4012** 25 mm
- 30.4013** 32 mm
- 200 mm



Smith - Petersen

- 30.4014** 6 mm
- 30.4015** 9 mm
- 30.4016** 13 mm
- 30.4017** 16 mm
- 30.4018** 19 mm
- 30.4019** 25 mm
- 30.4020** 32 mm
- 200 mm



Smith - Petersen

- 30.4021** 6 mm
- 30.4022** 9 mm
- 30.4023** 13 mm
- 30.4024** 16 mm
- 30.4025** 19 mm
- 30.4026** 25 mm
- 30.4027** 32 mm
- 200 mm



Lucas

- 40.0118** 3 mm
- 40.0119** 5 mm
- 160 mm



Lucas

- 40.0108** 4 mm
- 40.0109** 6 mm
- 160 mm

Dłuta żłobowe do kości łódkowatej

Scaphoid gouges

Желобоватые долота для ладьевидной кости

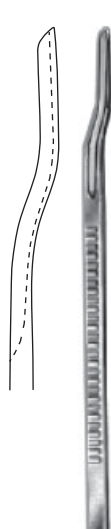

40.0123 3 mm
40.0124 5 mm
135 mm

wygięte w dół
curved downwards
изогнутые вниз

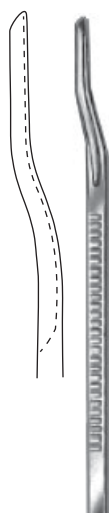

40.0178 3 mm
40.0179 5 mm
135 mm

wygięte w górę
curved upwards
изогнутые вверх



Zielke

40.0134 5,5 mm
40.0139 9 mm
230 mm

dłuto żłobowe
do operacji skolioz
gouge for scoliosis
surgery
долото желобоватое
для сколиозы



Aleksander

40.0236 6 mm
40.0237 8 mm
40.0238 10 mm
40.0239 12 mm
175 mm



Partsch

40.0174 3 mm
40.0175 4 mm
40.0176 5 mm
40.0177 6 mm
140 mm
40.0229 3 mm
40.0232 4 mm
40.0233 5 mm
40.0234 6 mm
40.0209 7 mm
170 mm



Partsch

40.0201 3 mm
40.0202 4 mm
40.0203 5 mm
40.0204 6 mm
140 mm
40.0145 3 mm
40.0146 4 mm
40.0147 5 mm
40.0148 6 mm
40.0149 7 mm
170 mm



Fomon

- 22.0009** 3 mm
- 22.0010** 4 mm
- 22.0011** 5 mm
- 22.0012** 6 mm
- 22.0013** 7 mm
- 170 mm

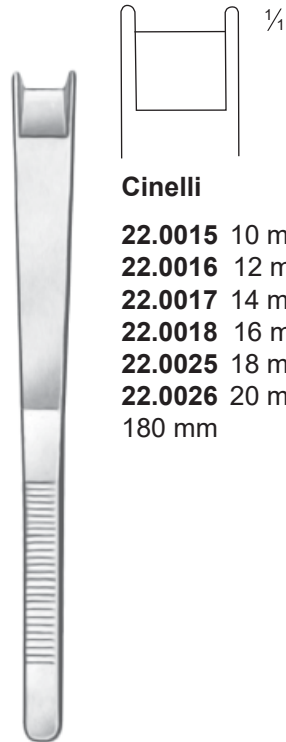

Cinelli

- 22.0015** 10 mm
- 22.0016** 12 mm
- 22.0017** 14 mm
- 22.0018** 16 mm
- 22.0025** 18 mm
- 22.0026** 20 mm
- 180 mm



Silver

- 22.0020** 4 mm
- 22.0027** 5 mm
- 180 mm

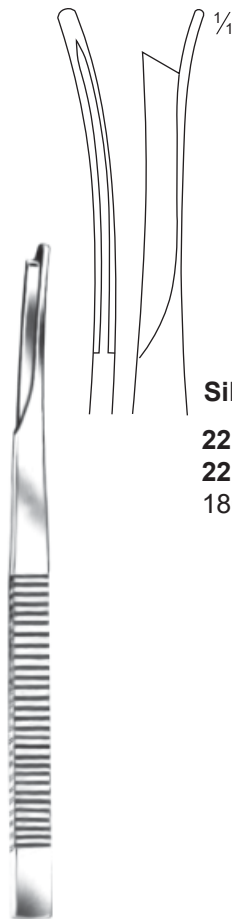

Silver

- 22.0021** 4 mm
- 22.0029** 5 mm
- 180 mm

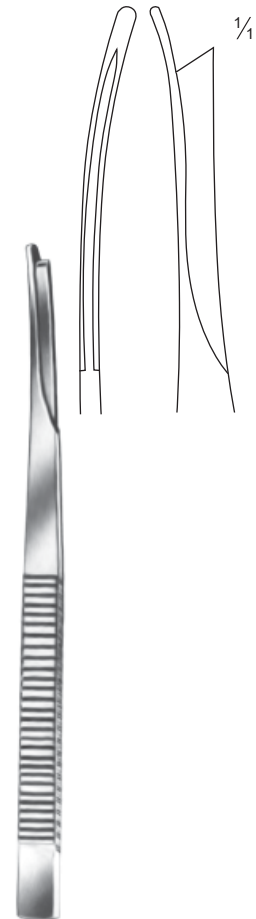

Silver

- 22.0022** 4 mm
- 22.0030** 5 mm
- 180 mm



Schede 170 mm
owalne • oval • овальные

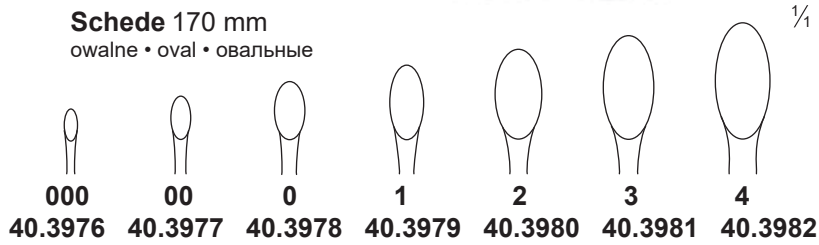

Volkmann 170 mm

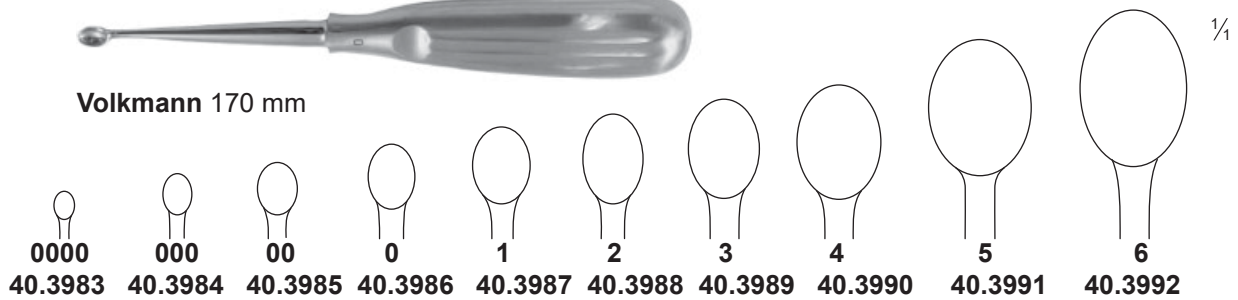

Bruns 170 mm
okragle • round • круглые

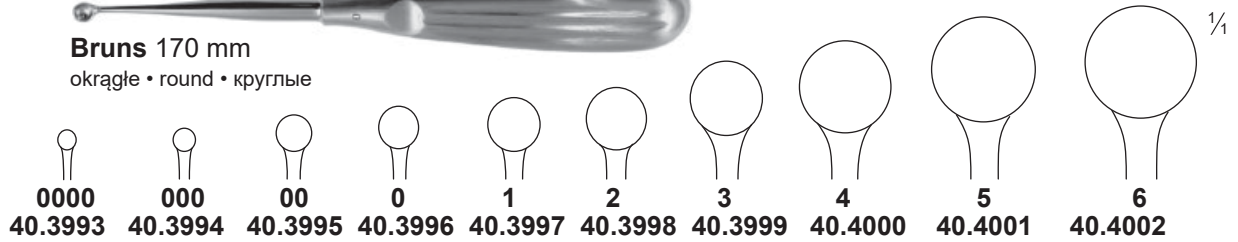

Bruns 170 mm
owalne • oval • овальные

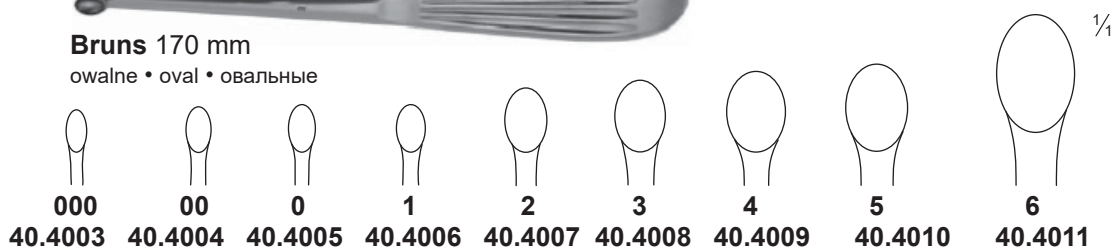

Bruns 230 mm
owalne • oval • овальные

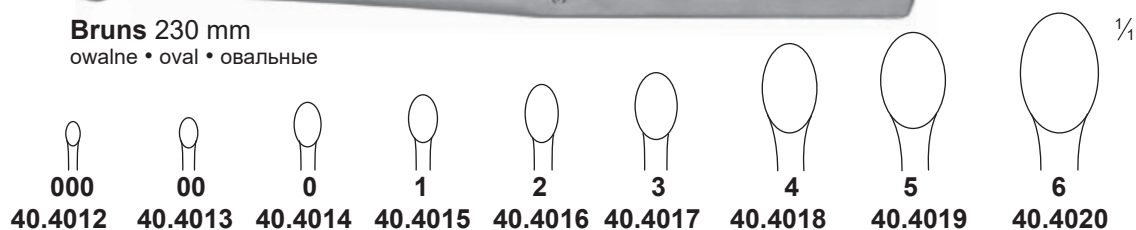



Bruns 230 mm

owalne • oval • овальные

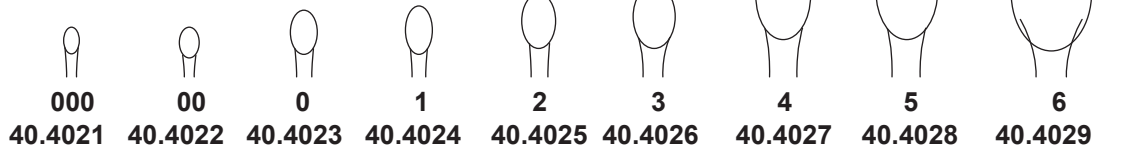

Bruns 230 mm

owalne • oval • овальные

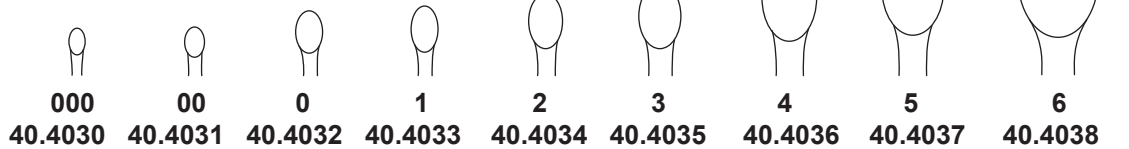

Willinger 170 mm

okrągłe • round • круглые



Spratt 170 mm

owalne • oval • овальные

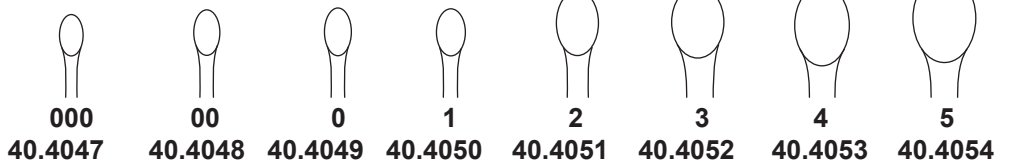

Daubenspeck 200 mm

owalne • oval • овальные

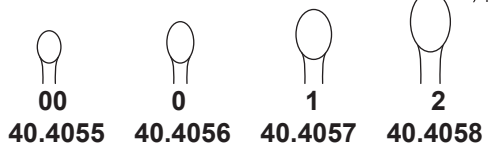

Simon 240 mm

owalne • oval • овальные

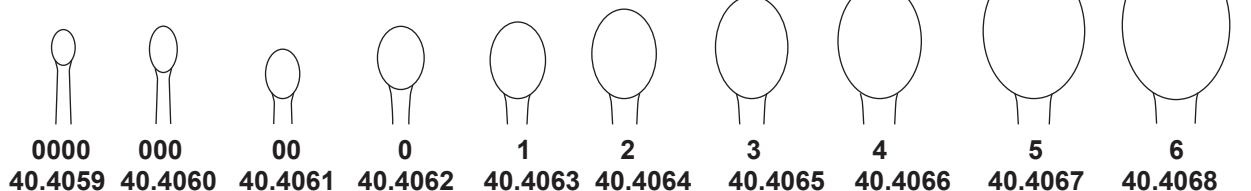



Volkmann 270 mm
owalne • oval • овальные

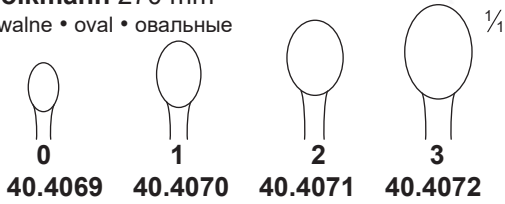

Halle 210 mm
giętka • flexible • гибкая

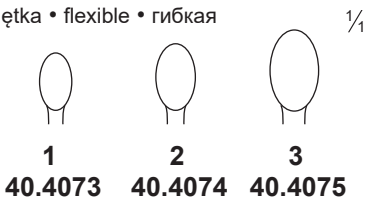

Lempert 210 mm
owalne • oval • овальные

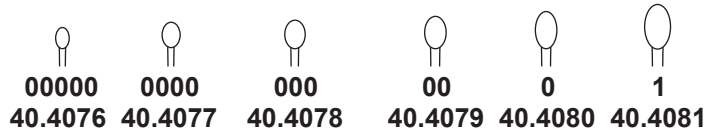

Volkmann 130 mm
40.4082



Volkmann 160 mm
40.4083



Jansen 150 mm
40.4085



Jansen 160 mm
40.4086



Jansen 140 mm
40.4087



Willinger 135 mm

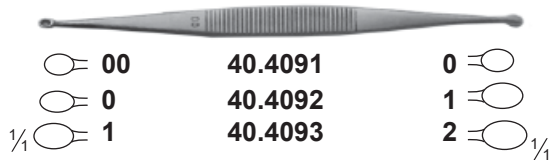

Martini 135 mm



Volkmann
40.4084
200 mm



Bergman

40.0257 Ø 45 mm 380g
240 mm

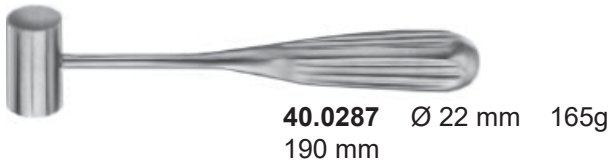

40.0287 Ø 22 mm 165g
190 mm



Hajek

40.0284 Ø 27 mm 140g
220 mm

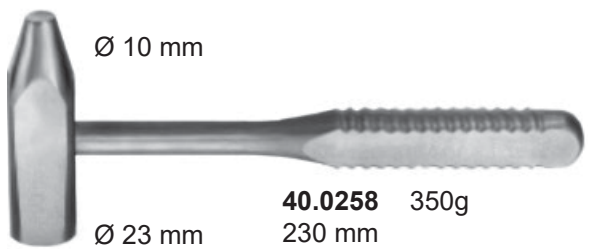

Ø 10 mm

Ø 23 mm

40.0258 350g
230 mm

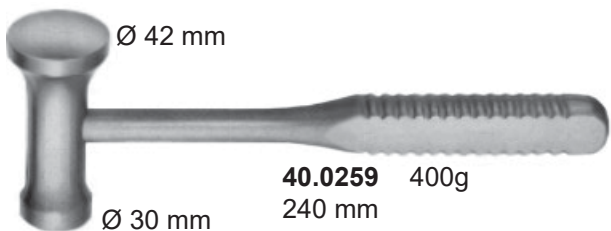

Ø 42 mm

Ø 30 mm

40.0259 400g
240 mm

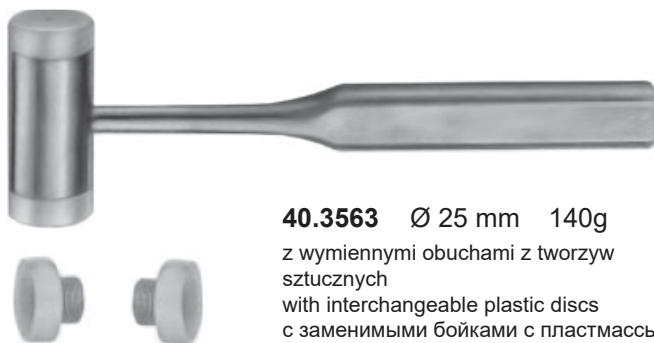

40.3563 Ø 25 mm 140g

z wymiennymi obuchami z tworzywa sztucznych
with interchangeable plastic discs
с заменимыми бойками с пластмассы

40.3564
komplet obuchów
pair of spare discs
комплект бойков

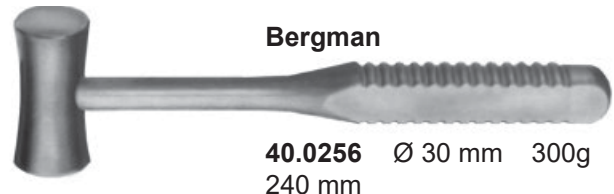

Bergman

40.0256 Ø 30 mm 300g
240 mm

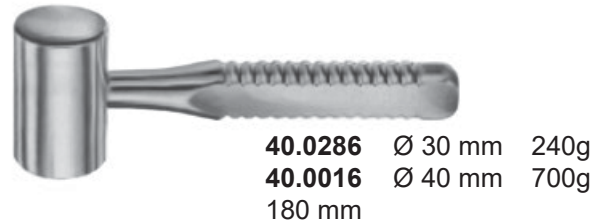

40.0286 Ø 30 mm 240g
40.0016 Ø 40 mm 700g
180 mm

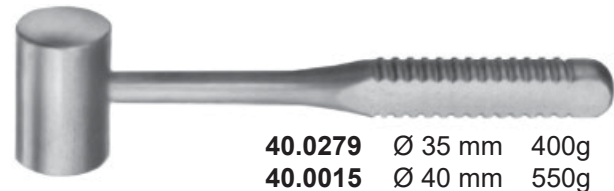

40.0279 Ø 35 mm 400g

40.0015 Ø 40 mm 550g

40.0282 Ø 42 mm 650g

40.0283 Ø 47 mm 900g

240 mm

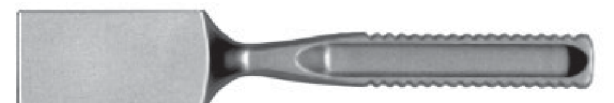

40.0073 150g 195 mm

40.0074 300g 210 mm

40.0075 450g 215 mm

40.0076 600g 220 mm

40.0077 750g 225 mm

40.0078 900g 230 mm

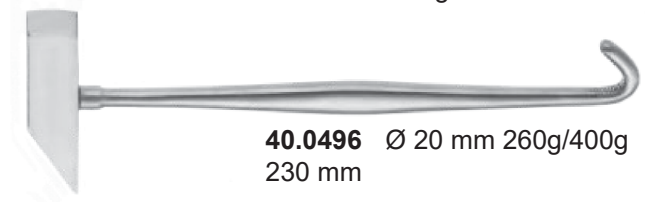

40.0496 Ø 20 mm 260g/400g
230 mm



40.0500.030 Ø 30 mm 450g

40.0500.050 Ø 50 mm 900g

265 mm

uchwyt z tworzywa

plastic handle

пластиковая рукоятка



Lambotte

- 40.0425** 5 mm
- 40.0426** 10 mm
- 40.0427** 15 mm
- 40.0428** 20 mm
- 40.0429** 25 mm
- 210 mm

13 mm



Farabeuf

- 40.0430**
- 150 mm

13 mm



Farabeuf

- 40.0431**
- 150 mm

17 mm



Langenbeck

- 40.0538**
- 190 mm

14 mm



Langenbeck

- 40.0539**
- 180 mm

8 mm



- 30.4066**
- 170 mm

7 mm



- 30.4067**
- 170 mm

7 mm



Adson

- 30.4068**
- 170 mm

7 mm



- 30.4069**
- 170 mm

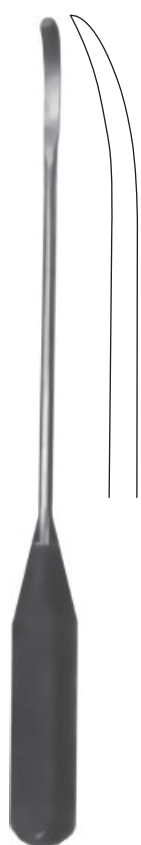

8 mm

Wagner
30.4055
330 mm



17 mm

Wagner
30.4056
330 mm



14 mm

30.4057
200 mm

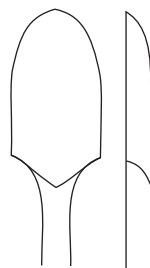

14 mm

30.4058

13 mm

30.4065
200 mm

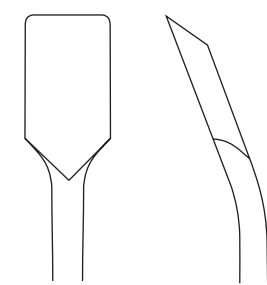
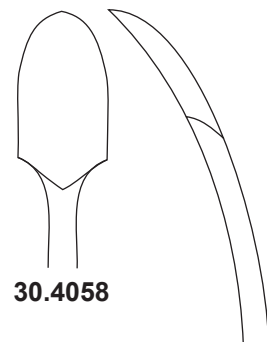

20 mm

30.4059
200 mm

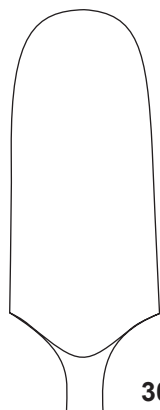

13 mm

30.4064
200 mm

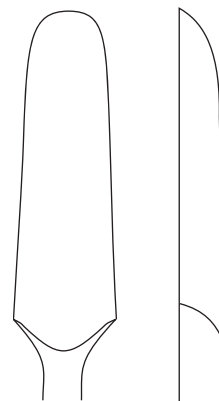

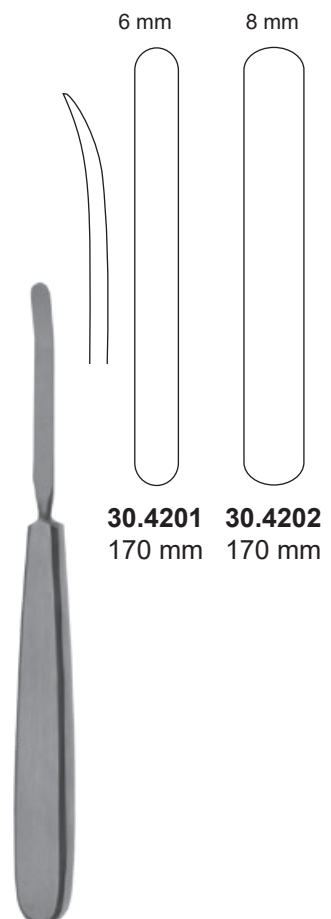
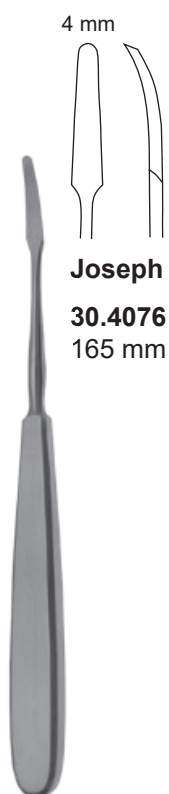
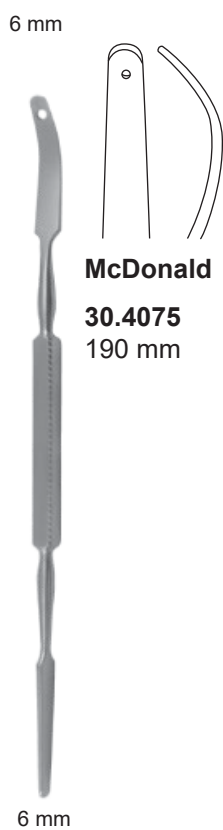
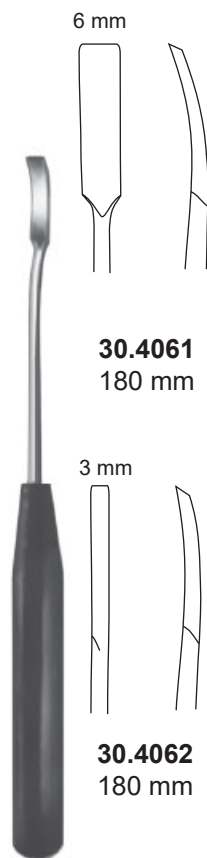

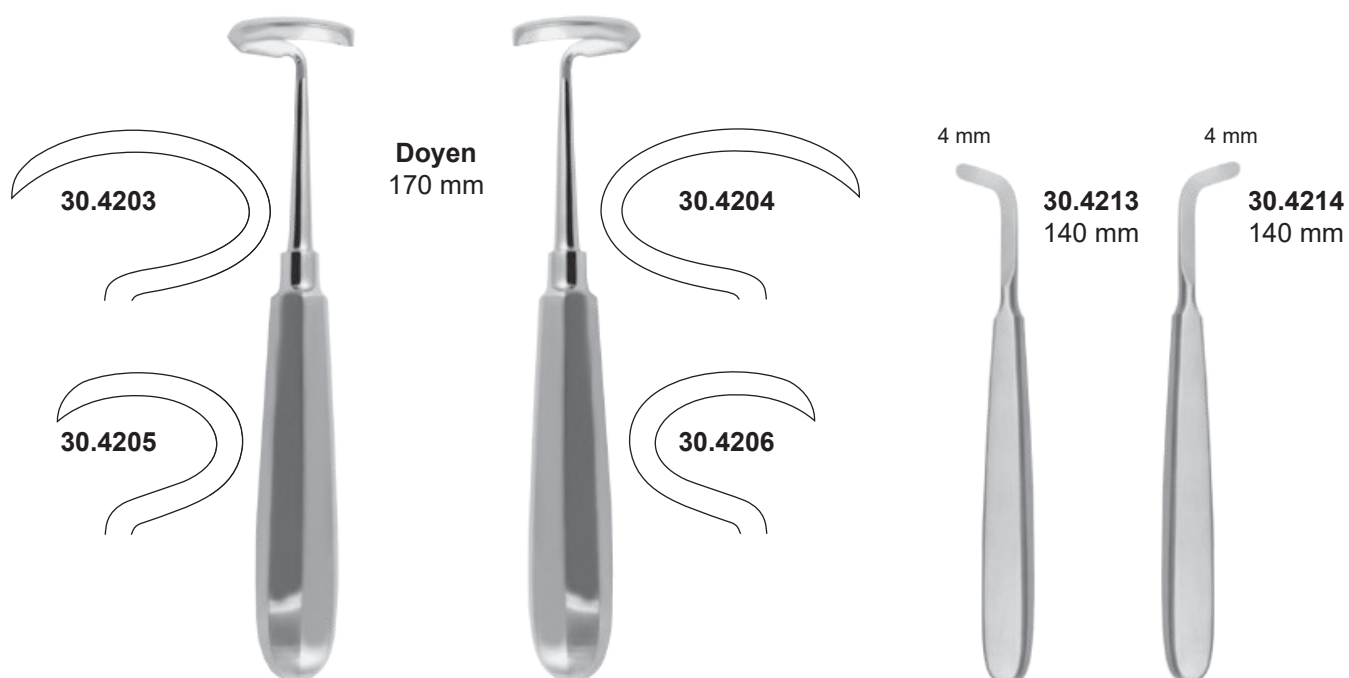

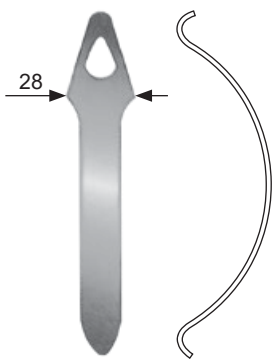

40.1207
155 mm

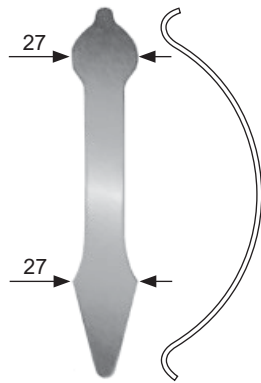

40.1208
165 mm



40.1209
165 mm

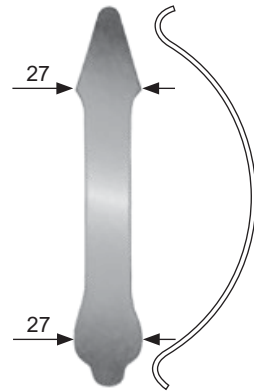

40.1210
170 mm

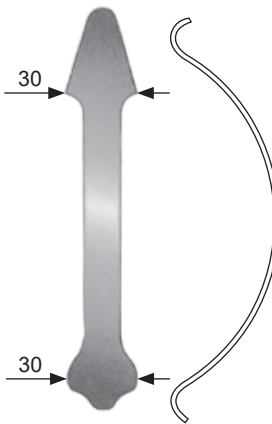

40.1211
180 mm

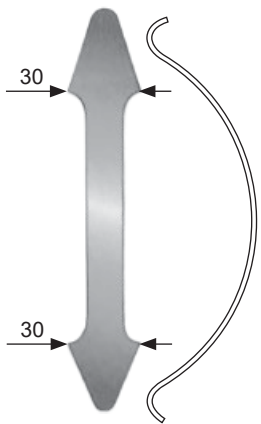

40.1212
180 mm

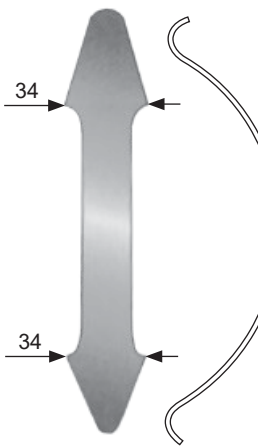

40.1213
190 mm

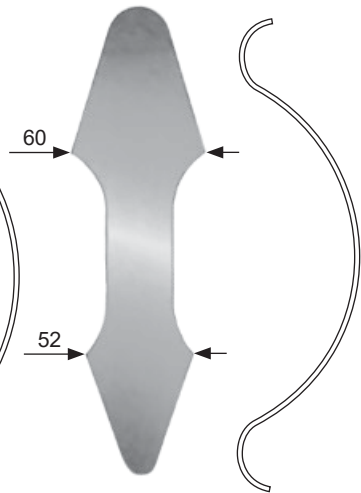

40.1214
210 mm

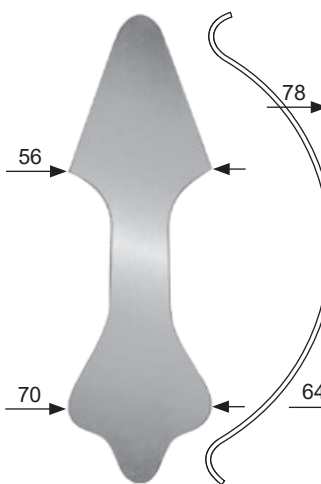

40.1215
210 mm

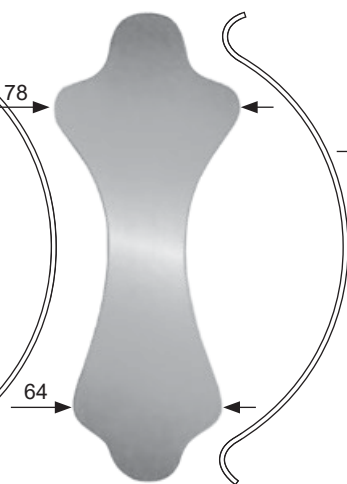

40.1216
210 mm

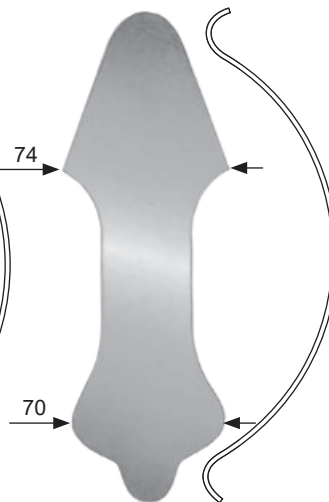

40.1217
220 mm

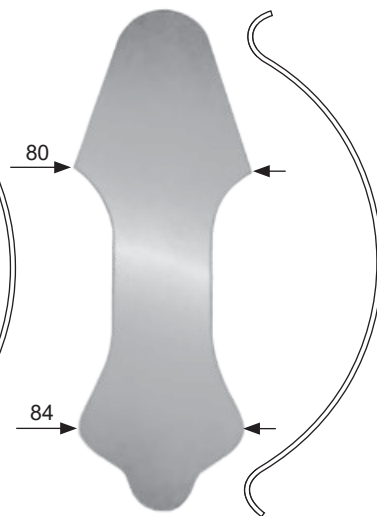

40.1218
225 mm

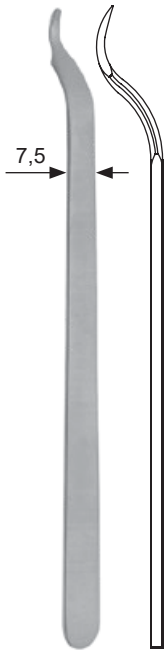

Buck-Gramcko
40.2185
150 mm

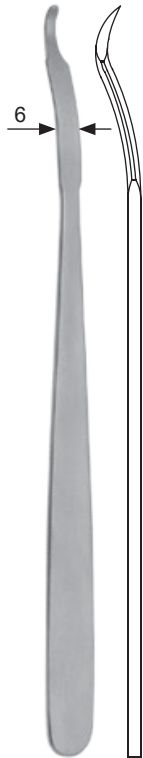

Mini-Hohmann
40.2186
160 mm



40.2187
160 mm



40.2188
125 mm



Lange-Hohmann
40.2189
260 mm



Lange-Hohmann modyf.
40.2190
265 mm



40.2191
290 mm



Wagner
40.2192
220 mm

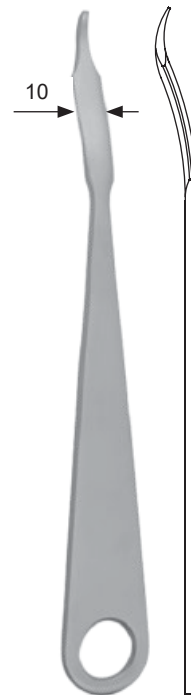

Hohmann
40.2193
220 mm



Hohmann
40.2194
240 mm



Hohmann
40.2195
240 mm



Hohmann - Aldinger
40.2196
270 mm



Hohmann
40.2197
240 mm

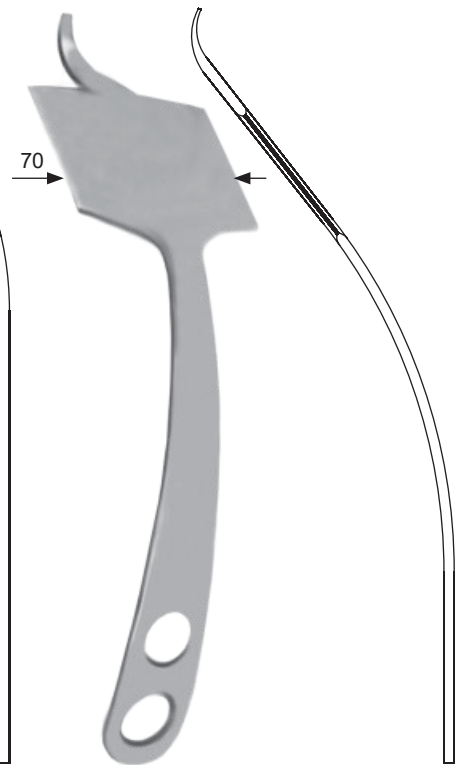

Hohmann
40.2198
240 mm



Hohmann
40.2199
270 mm



Hohmann
40.2200
260 mm



Hohmann
40.2201
280 mm



Bennet
40.2203 45 mm
40.2204 65 mm
240 mm

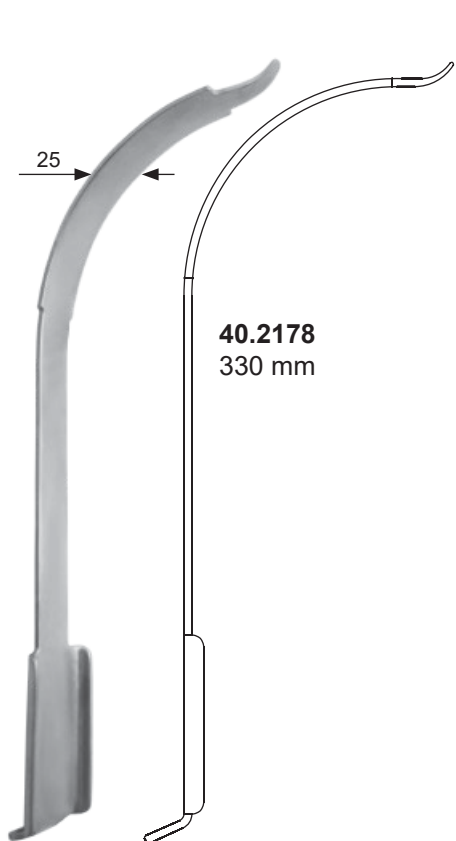

40.2178
330 mm

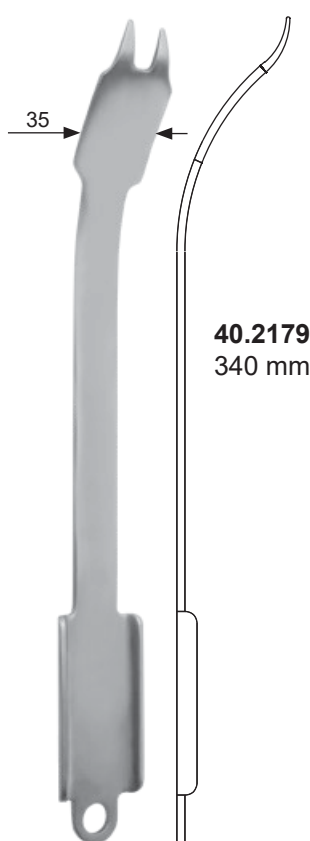

40.2179
340 mm



40.2180
340 mm

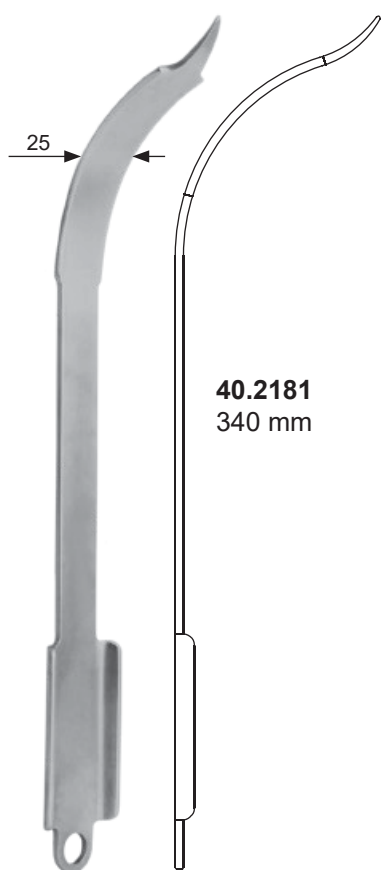

40.2181
340 mm

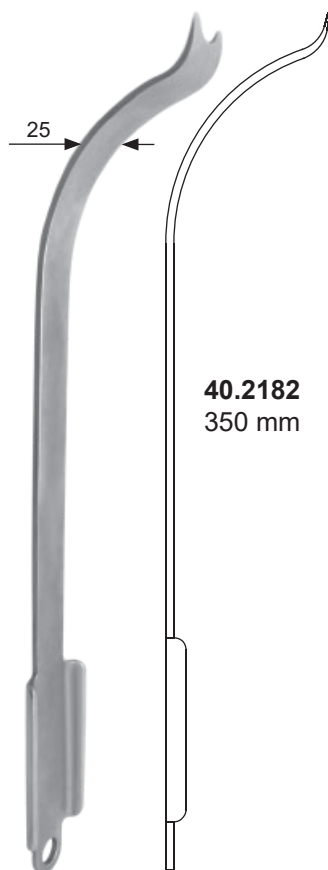

40.2182
350 mm

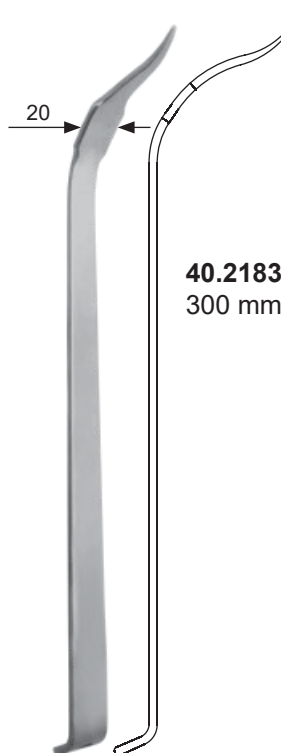

40.2183
300 mm

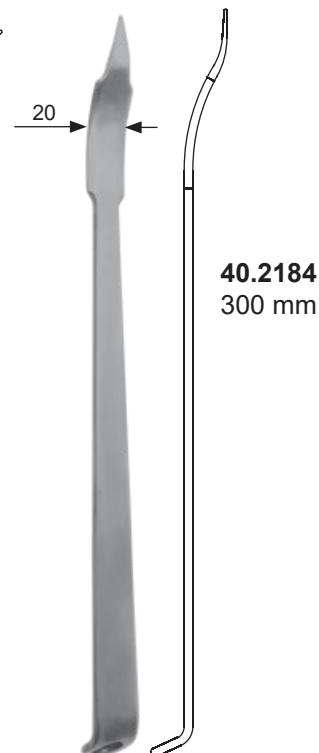

40.2184
300 mm

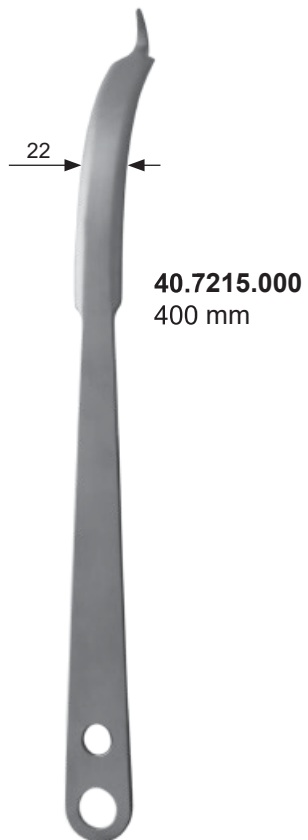
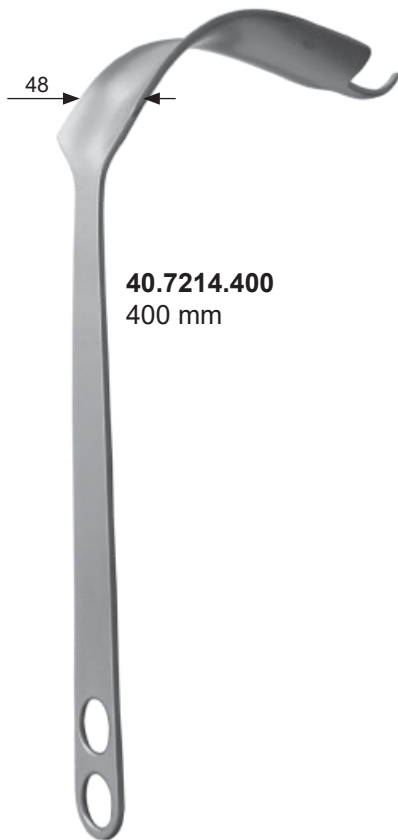

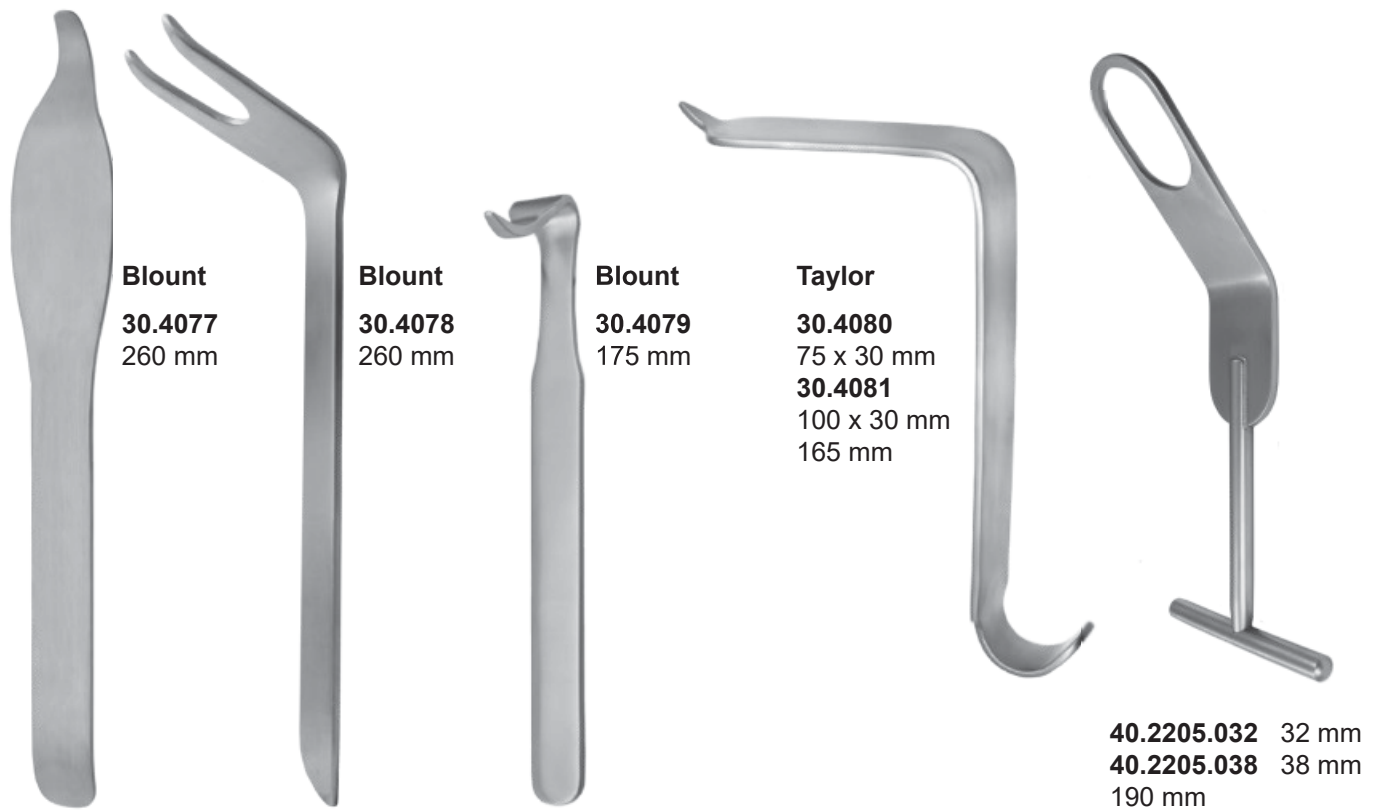
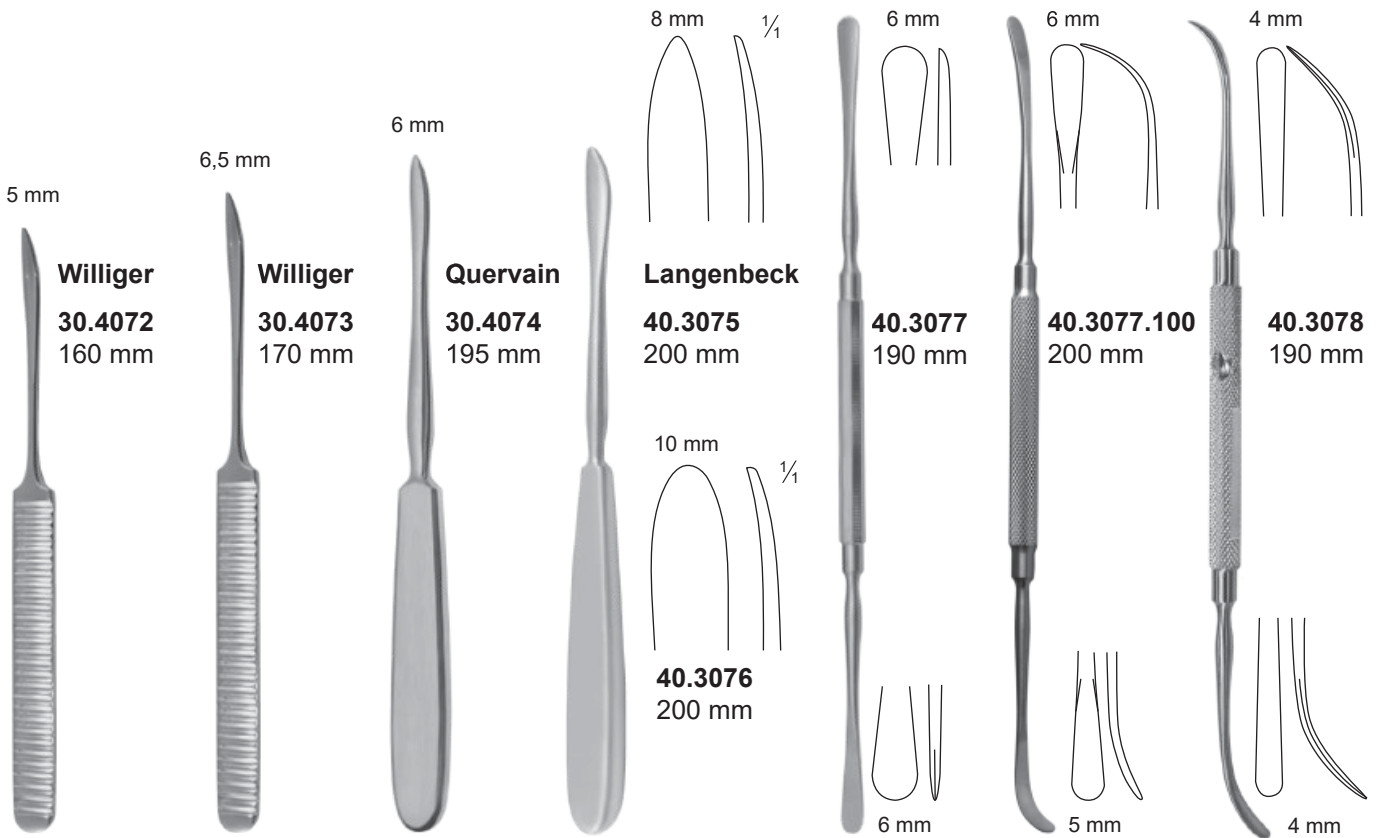



Stille-Ruskin

40.0252.106 6 mm
40.0252.107 7 mm
40.0252.108 8 mm

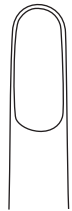

40.0252.006 6 mm
40.0252.007 7 mm
230 mm

5 mm



Zaufal Jansen

40.0255
170 mm

4 mm



4 mm

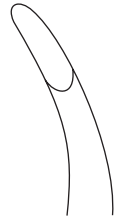

Jansen

40.0260 40.0261
175 mm 175 mm

10 mm

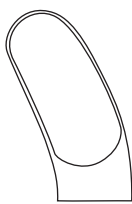

10 mm

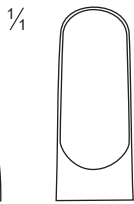

Stille-Luer

40.3276 40.3275
220 mm 220 mm

3 mm



Beyer

40.3309
180 mm

3 mm



Beyer

40.3309.100
180 mm



Echlin

40.3310 2 mm
40.3311 3 mm
40.3312 4 mm
230 mm

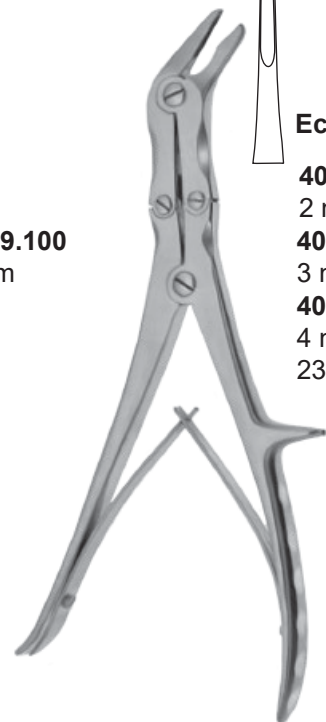
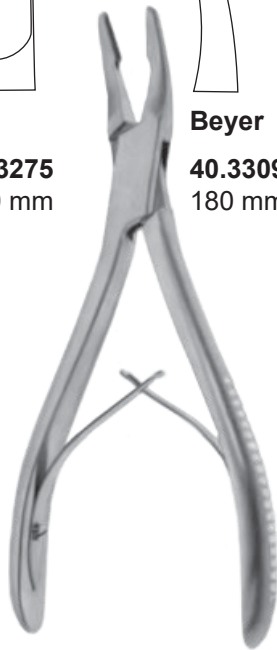
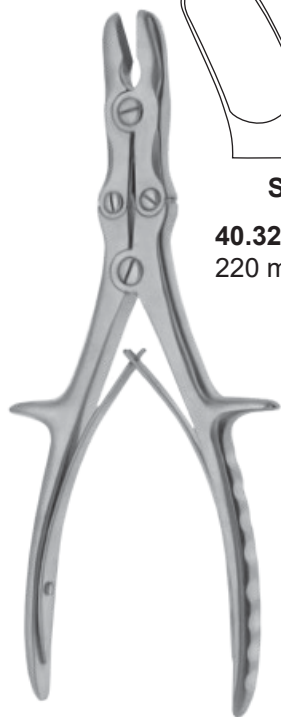



Böhler

40.3313 3 mm
40.3802 4 mm
40.3803 5 mm



Ruskin

40.3315 4 mm
40.3316 5 mm
40.3317 6 mm



Frykholm

40.3806
240 mm



40.3314 3 mm
40.3804 4 mm
40.3805 5 mm
150 mm



40.3318 4 mm
40.3800 5 mm
40.3801 6 mm
180 mm



Rottgen-Ruskin

40.3337.004 4 mm
40.3337.005 5 mm
40.3337.006 6 mm
240 mm



40.3338.004 4 mm
40.3338.005 5 mm
40.3338.006 6 mm
240 mm

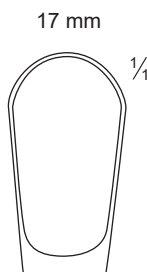
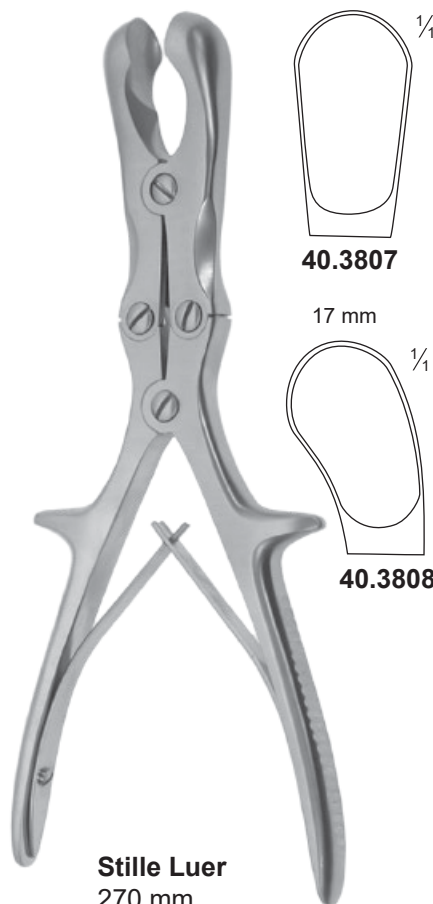

40.3807

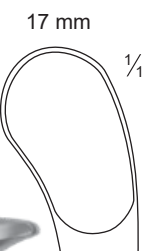

40.3808

Stille Luer
270 mm

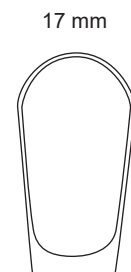
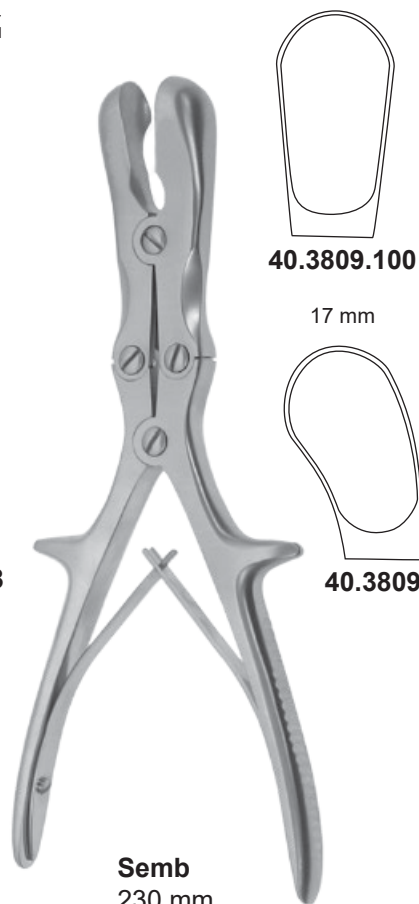

40.3809.100



40.3809

Semb
230 mm

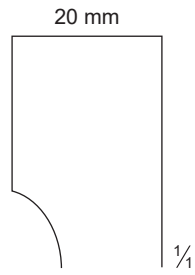

Sauerbruch
40.3810

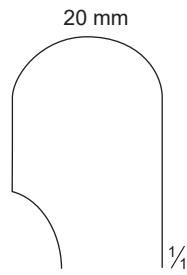

40.3811
310 mm

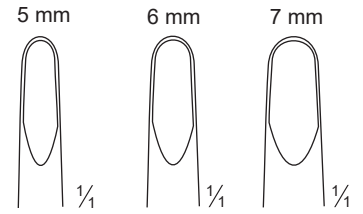
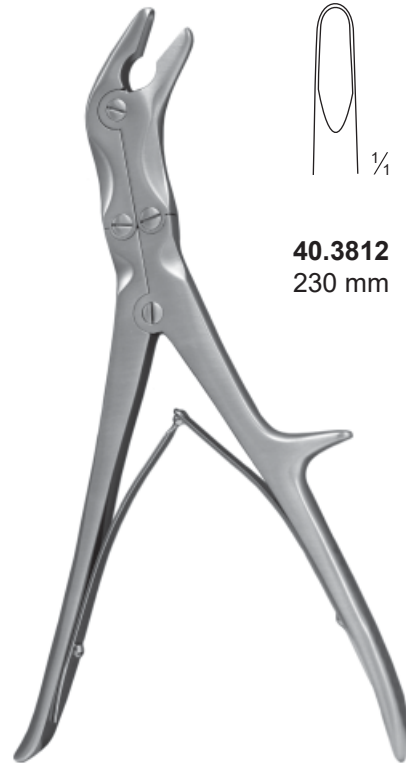

Stille

40.3812 230 mm
40.3813 230 mm
40.3814 230 mm

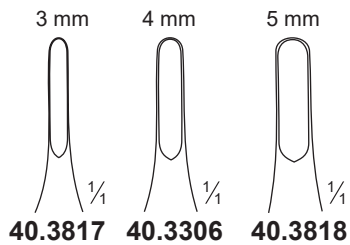

40.3817 **40.3306** **40.3818**

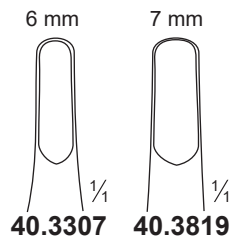

40.3307 **40.3819**

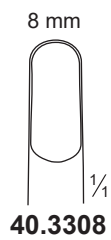

40.3308

Leksell
240 mm

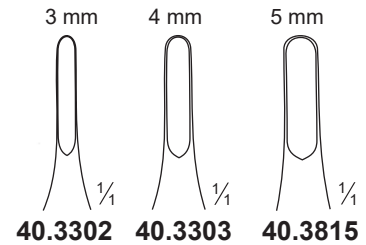

40.3302 **40.3303** **40.3815**

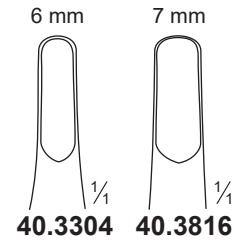

40.3304 **40.3816**

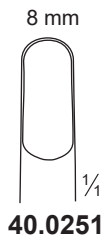

40.0251

Leksell
240 mm



Syfert
360 mm

3 mm



40.3339.003

4 mm



40.3339.004

5 mm



40.3339.005

6 mm



40.3339.006

7 mm



40.3339.007

8 mm



40.3339.008

12 mm



40.3339.012

2,5 mm 3 mm 4 mm

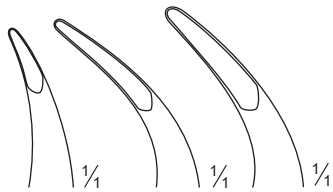

Luer

40.3820 40.3821 40.3822
150 mm 150 mm 150 mm



8 mm 8 mm

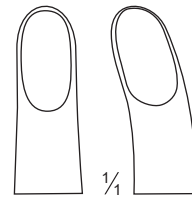

Luer

40.3823 40.3824
170 mm 170 mm



5 mm

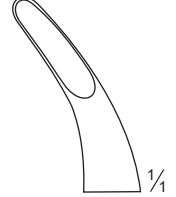

Olivecron

40.3825
200 mm



2 mm 2 mm

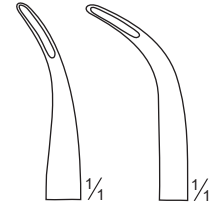

Stellbrink

40.3827 40.3828
170 mm 170 mm



3 mm



Mini-Friedmann

40.3829
120 mm



3 mm



Friedmann

40.3830
140 mm



1,5 mm



Micro-Friedmann

40.3831
140 mm



4 mm



Cleveland

40.3832
140 mm



4,5 mm



Cleveland

40.3833
170 mm



40.3834
30°
155 mm

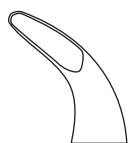

Blumenthal
40.3835
45°
150 mm

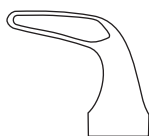

40.3837
90°
155 mm

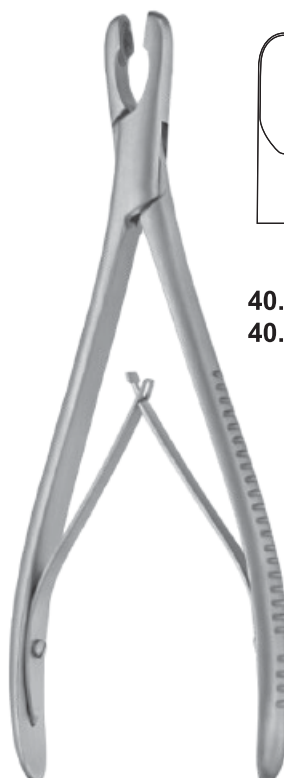

40.3838
40.3839

7 mm
8 mm
200 mm



Adson

40.3840
40.3841

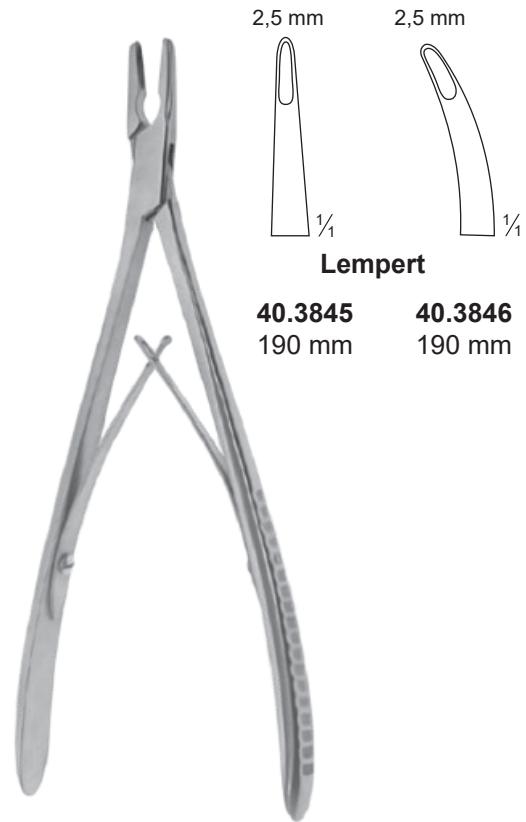
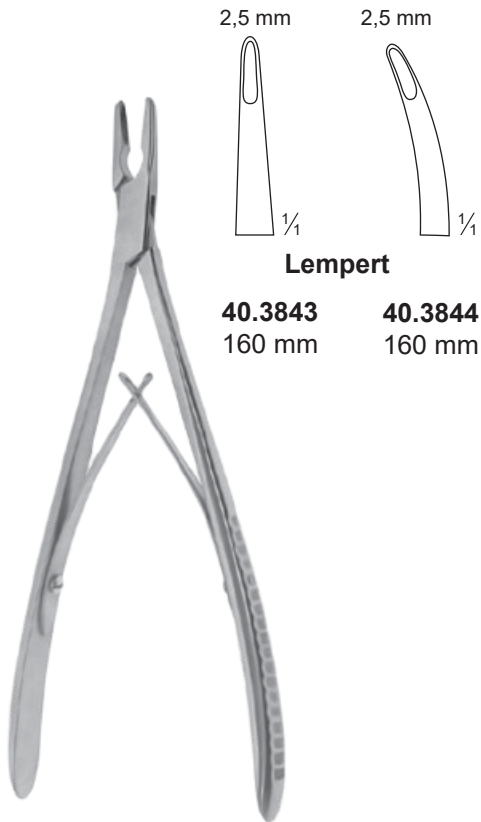

nakładka zabezpieczająca
guarding overlay
защитная накладка
40.3849

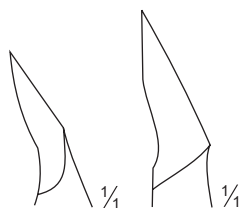

Cleveland

40.3895 40.3896
150 mm 170 mm

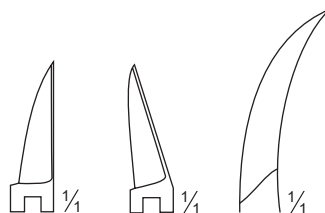

Böhler

40.3897 40.3898 40.3899
150 mm 150 mm 150 mm

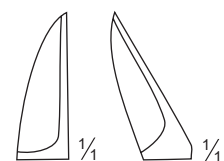

Liston mini

40.3900 40.3901
150 mm 150 mm

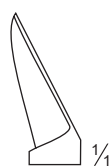

Mc Indoe

40.3902
170 mm

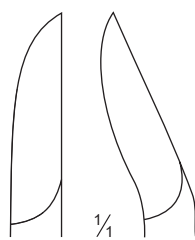

Ruskin

40.3903 40.3904
180 mm 180 mm

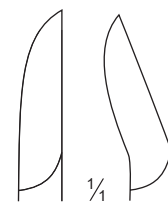

Ruskin-Liston

40.3566 40.3567
180 mm 180 mm



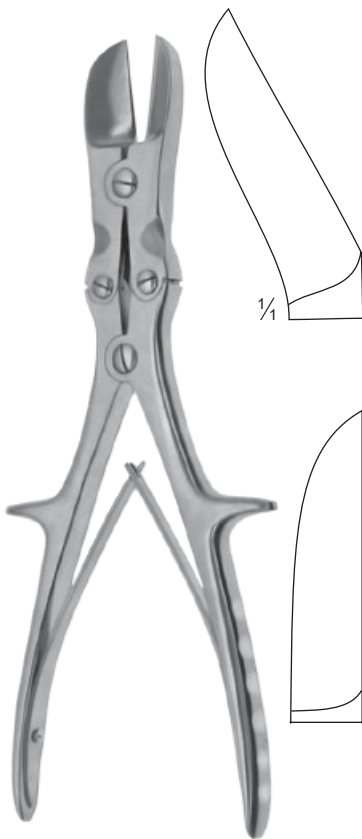

Stille-Liston

40.3907 270 mm
40.3922 230 mm

40.3908 270 mm
40.3921 230 mm



Liston

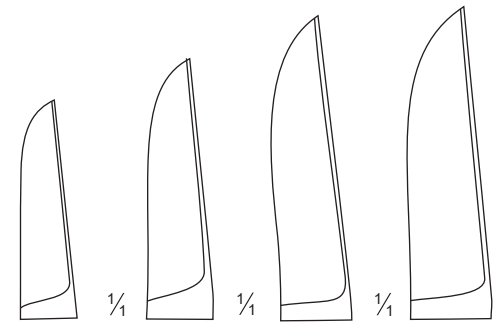

40.3909 140 mm **40.3910** 170 mm **40.3911** 200 mm **40.3912** 220 mm

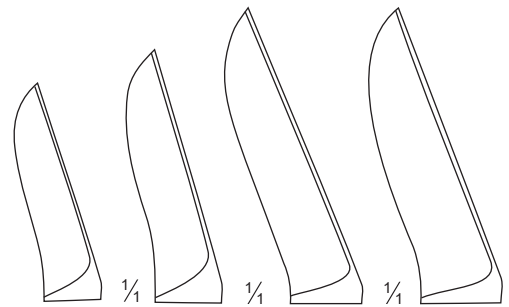

40.3913 140 mm **40.3914** 170 mm **40.3915** 200 mm **40.3916** 220 mm



Liston Key

40.3905
270 mm



Stille-Liston

40.3906
270 mm



Semb

40.3917
230 mm

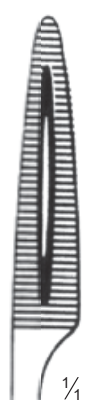

40.4147
200 mm

1/4



40.4148
200 mm

1/4

40.4149
120 mm



40.4150
135 mm

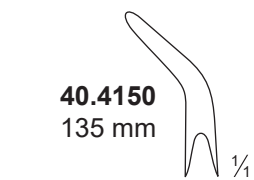

1/4

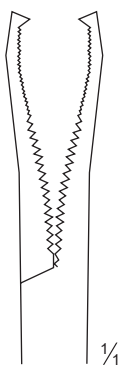

1/4

Dingmann

40.4151
190 mm

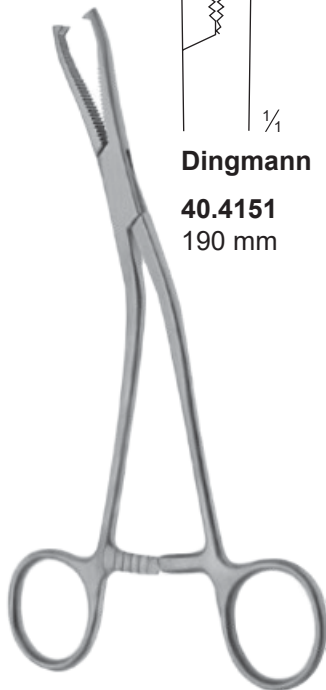

40.4152
210 mm



40.4153
140 mm



Lewin

40.4154
175 mm



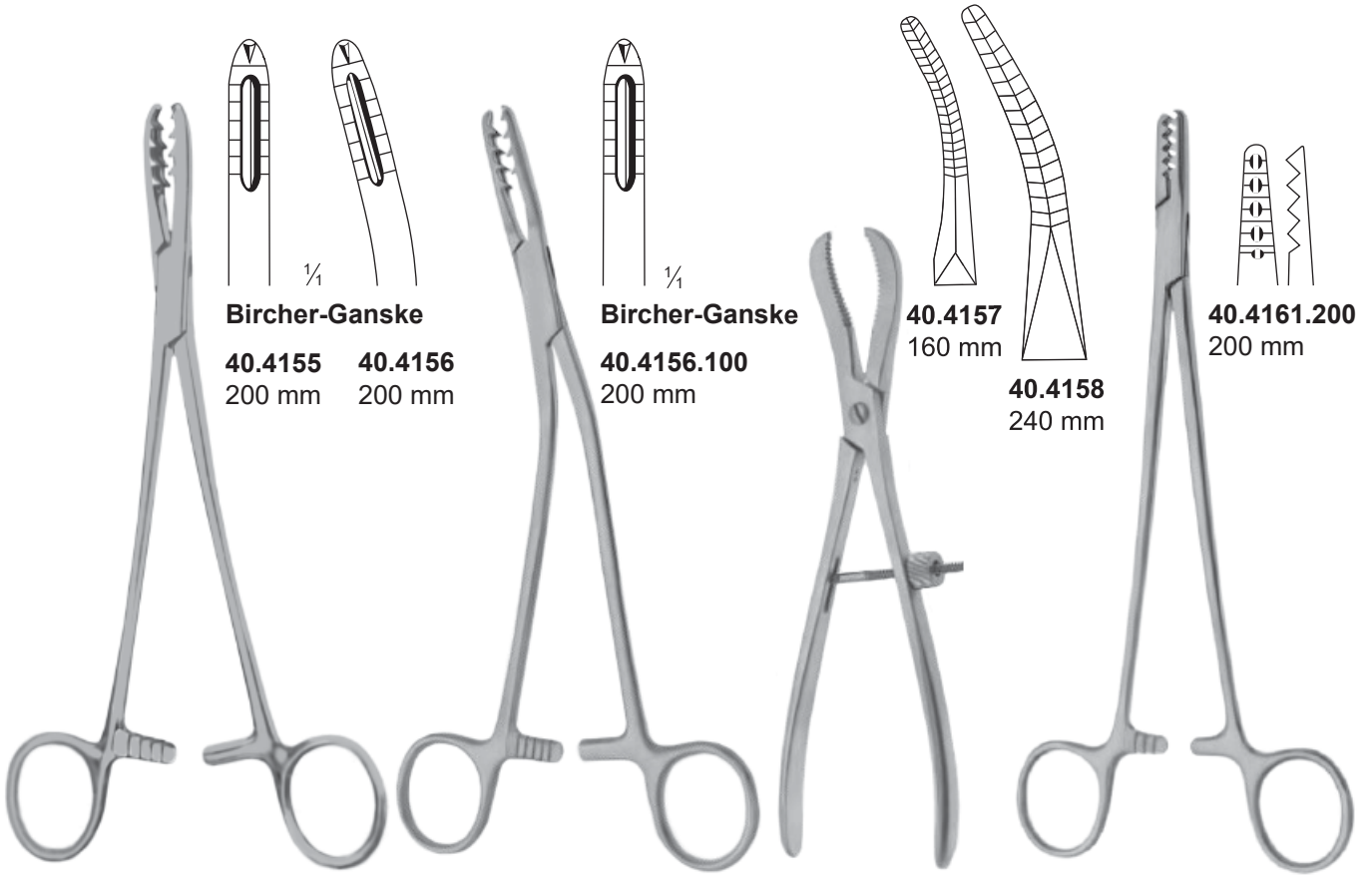

Bircher-Ganske
40.4155 200 mm 40.4156 200 mm

Bircher-Ganske
40.4156.100 200 mm

40.4157 160 mm
40.4158 240 mm

40.4161.200 200 mm

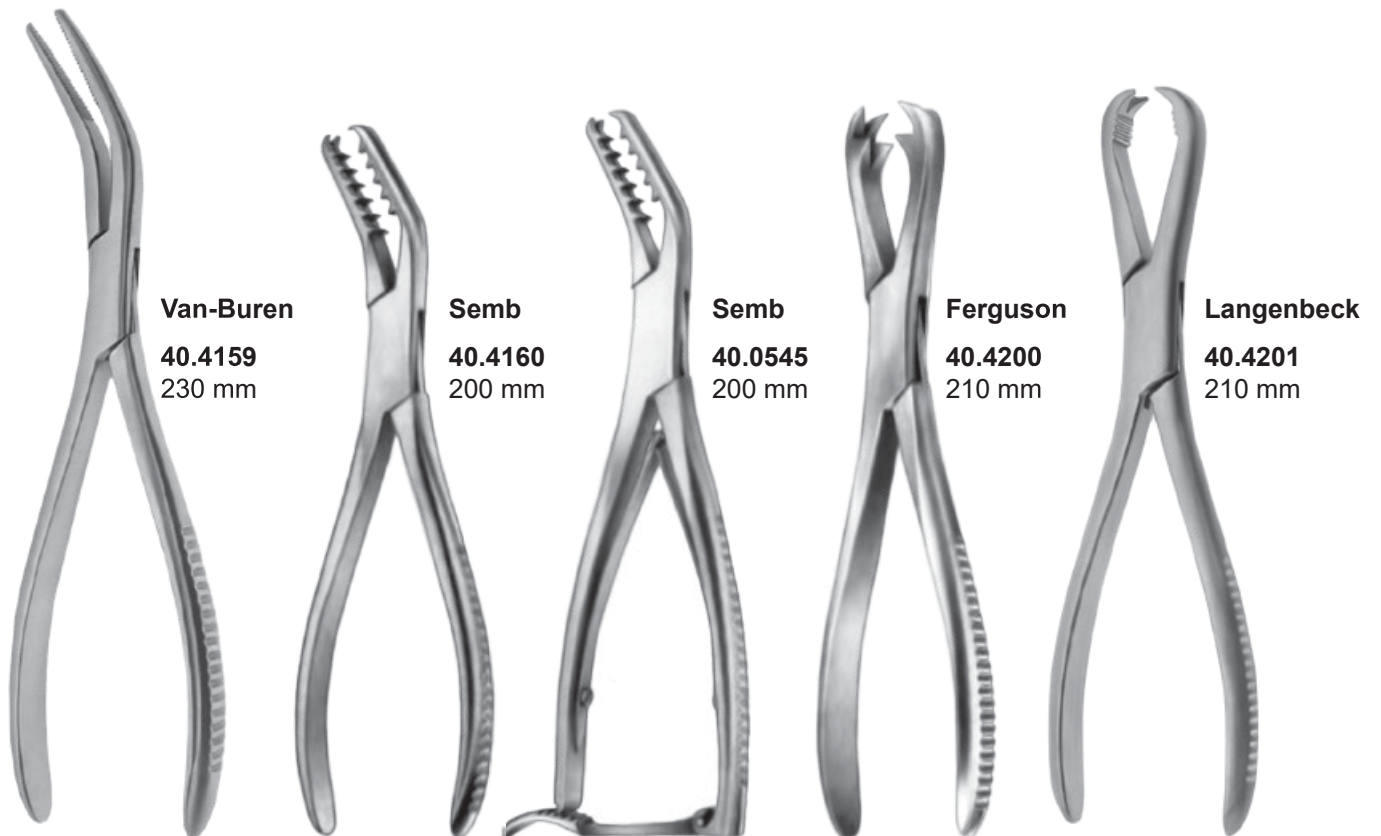

Van-Buren
40.4159 230 mm

Semb
40.4160 200 mm

Semb
40.0545 200 mm

Ferguson
40.4200 210 mm

Langenbeck
40.4201 210 mm



Farabeuf

40.4202 230 mm
40.4203 260 mm



Farabeuf-Lambotte

40.6016 200 mm
40.4204 260 mm



40.4205
200 mm

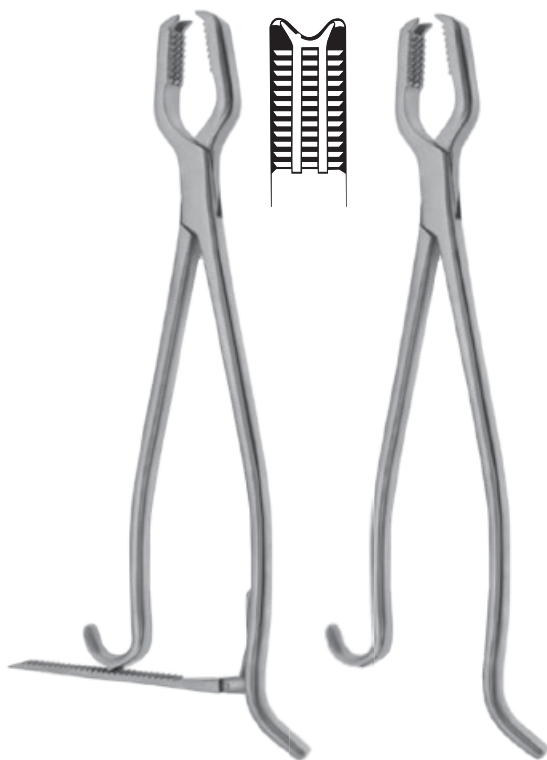

Kern

40.4208 150 mm **40.4209**
40.4206 170 mm **40.4210**
40.4207 210 mm **40.4211**



40.7261
170 mm

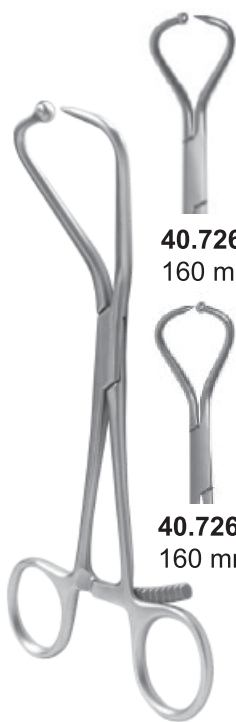

40.7262.001
160 mm

40.7262.002
160 mm



40.7262
180 mm



40.7263
205 mm

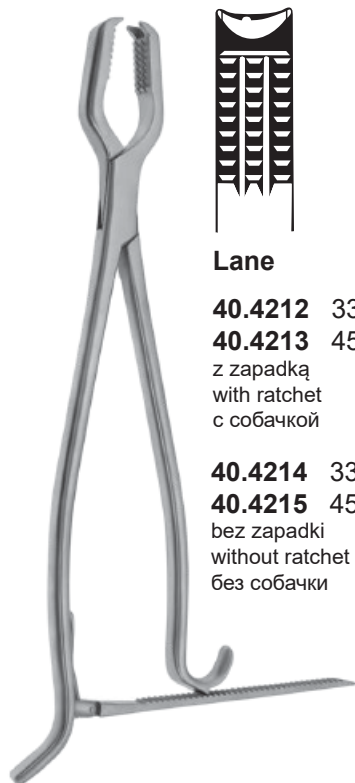

Lane

40.4212 330 mm

40.4213 450 mm

z zapadką
with ratchet
с собачкой

40.4214 330 mm

40.4215 450 mm

bez zapadki
without ratchet
без собачки



Lambotte

40.4216 220 mm

40.4217 260 mm

40.4218 330 mm



Lambotte

40.4219

220 mm

40.4220

260 mm

40.4221

330 mm



Lambotte

40.4222

190 mm

40.4223

230 mm

40.4224

260 mm



Verbrugge

40.4229 2,5 mm

150 mm

40.4230 6,5 mm

190 mm

40.4231 9,5 mm

240 mm

40.4232 10 mm

260 mm

40.4233 11 mm

280 mm

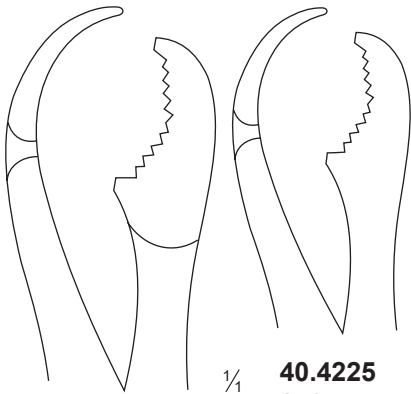

1/4 40.4225
250 mm

40.4227
270 mm

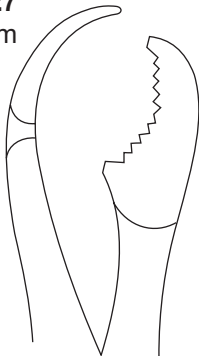

40.4226
260 mm

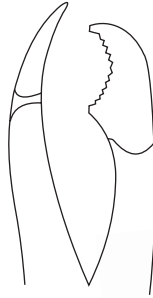

40.4228
175 mm



Verbrugge



Verbrugge-Baby



40.4228.100
175 mm



Verbrugge-Baby

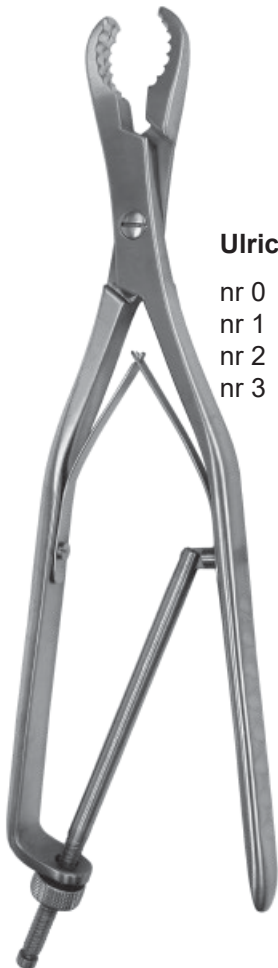

Ulrich

- nr 0 40.0100
- nr 1 40.0101
- nr 2 40.0102
- nr 3 40.0103

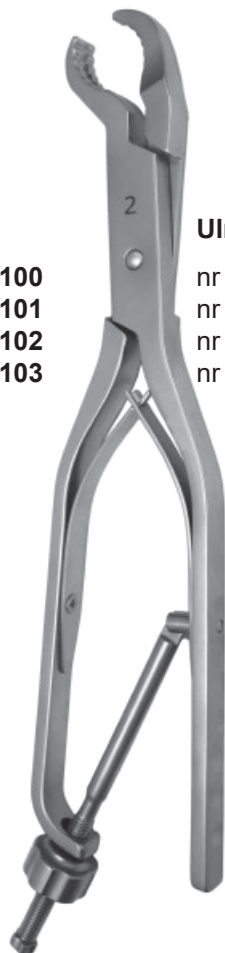

2

Ulrich

- nr 0 40.0415
- nr 1 40.0416
- nr 2 40.0417
- nr 3 40.0418



3

Ulrich

- nr 0 40.0420
- nr 1 40.0421
- nr 2 40.0422
- nr 3 40.0423



nr 0
180 mm



nr 1
210 mm

1/4



nr 2
220 mm



nr 3
250 mm



Lowman

- 40.4240** 120 mm
- 40.4241** 180 mm
- 40.4242** 200 mm



Lowman-Baby

- 40.4234** 130 mm

Lowman-Hougland

- 40.4235** 180 mm



Gester-Lowman

- 40.4236** 120 mm
- 40.1100** 180 mm
- 40.1101** 200 mm
- 40.1102** 220 mm



Gerster

- 40.4243**
150 mm

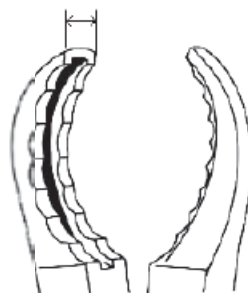

Hey-Groves

- 40.1103** 6,5 mm
210 mm
- 40.1104** 7,5 mm
270 mm
- 40.1105** 8,5 mm
305 mm

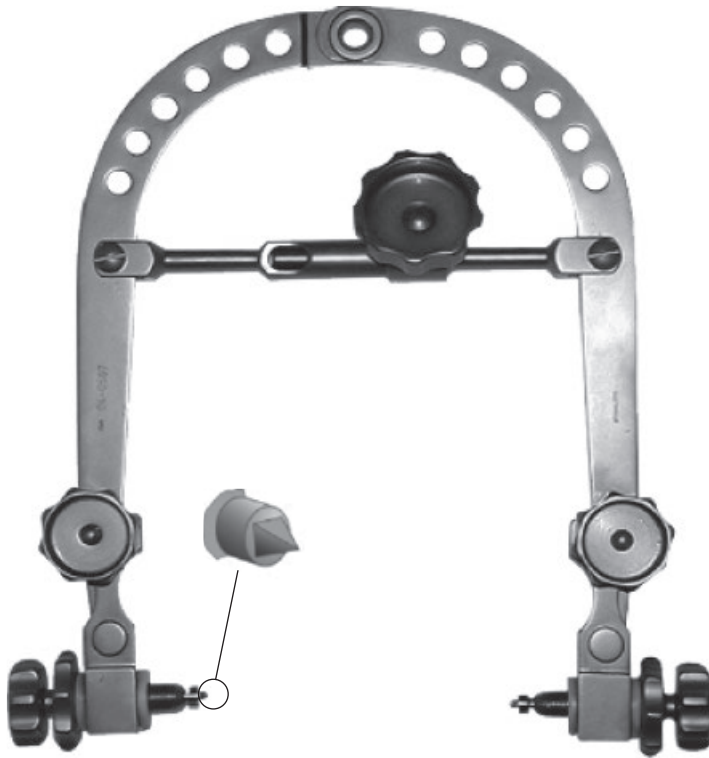

40.0586

Klamra do manipulacji repozycyjnej i wyciągu długotrwałego. Ostre zakończenia zaczepów czaszkowych oraz zastosowanie mechanizmów śrubowych do regulacji wgłębienia eliminują użycie specjalnych wiertel do nawiercania zewnętrznej warstwy kości. Konstrukcja zaczepów uniemożliwia nadmierne ich zagłębienie w czaszce.

Skull traction tong is intended for reposition and prolonge traction. Sharp-ended pins and screw gears for hollow regulation eliminate using special drill for spotting the outer layer bone. The pin construction protects from excessive hollow of pins.

Скобы для репозиционной манипуляции и длительного вытяжения. Благодаря острым окончаниям черепных фиксирующих элементов, а также применению винтовых механизмов для регуляции полости нет необходимости использования специальных сверл для сверления наружного слоя кости. Конструкция фиксирующих элементов предохраняет от чрезмерного заглубления в кости.

W skład zestawu wchodzi:

Kit consists of:

Набор содержит:

40.0619

Нак wyciągowy

Traction hook

Крючок для скоб

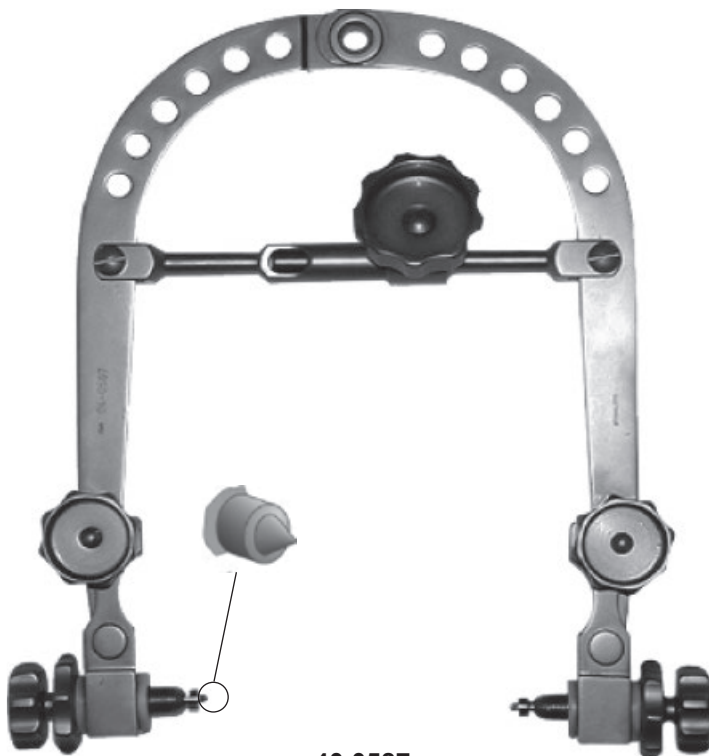

40.0587



Klucz

Wrench

Ключ

40.0621

SW 10x17



40.0610



Klucz
Wrench
Ключ
40.0621
SW 10x17



Hak wyciągowy
Traction hook
Крючок для скоб
40.0619



Ciężarki do wyciągu
Traction weights
Грузы для вытяжения
40.0835 0,5 kg
40.0836 1,0 kg
40.0837 2,0 kg



Uchwyt do ciężarków
Weight shank
Держатель для грузов
40.0839

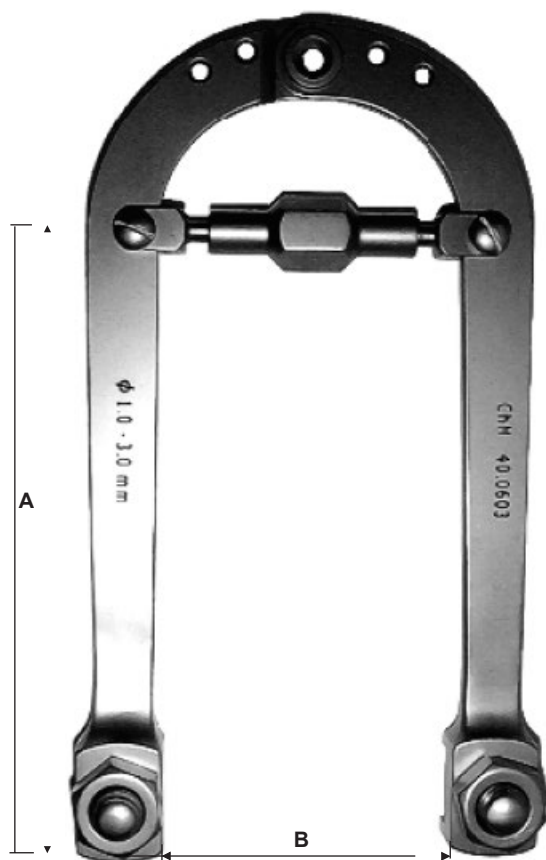

	A	B	Klucz Wrench Ключ
40.0603	~ 100 mm	40 mm - 125 mm	40.6069 SW 14x17
40.0604	~ 120 mm	60 mm - 160 mm	
40.0605	~ 160 mm	75 mm - 200 mm	40.8709 SW 19x14

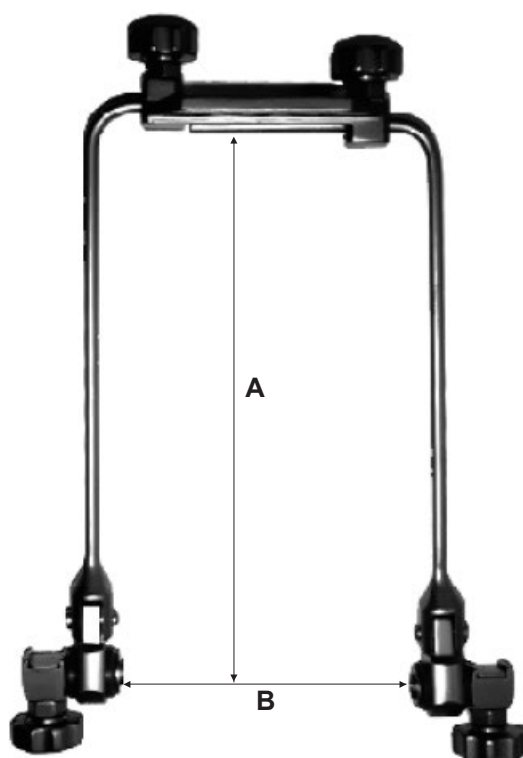

A: 180 mm
B: 85 - 180 mm

40.0585

Zestaw do wyciągowego czynnościowego leczenia złamań

(zapewnia unieruchomienie gwoździ Steinmanna w kości)

Skeletal functional traction kit
(secures immobilizing the Steinmann nail in the bone)

Набор для скелетного вытяжения при лечении переломов (обеспечивает неподвижную фиксацию стержней Штейнманна в кости)

Gwóźdź Steinmanna

Steinmann nail

Стержень Штейнманна
Ø 4 mm, Ø 4,5 mm, Ø 5 mm

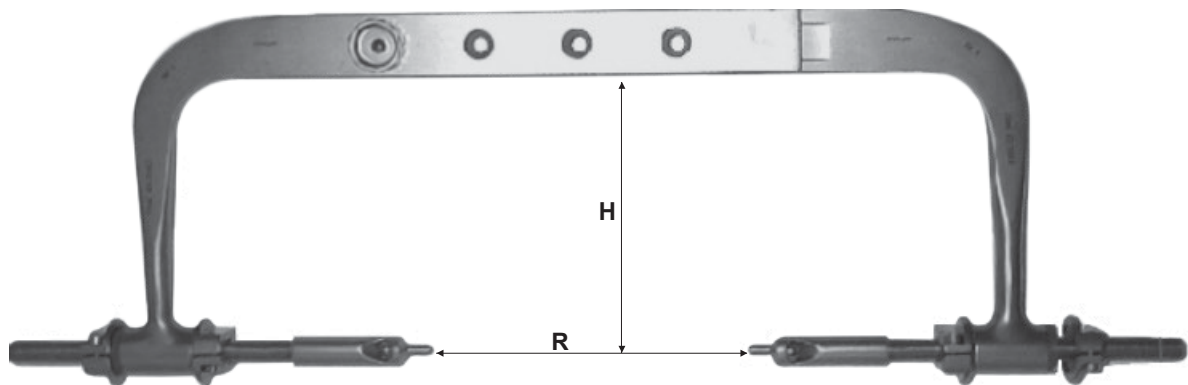

	H	R _{max}
40.0582	11 cm	30 cm
40.0583	12 cm	36 cm
40.0584	14 cm	44 cm

Klamra Molskiego służy do unieruchomienia i utrzymania prawidłowego ustawienia kości obręczy miedniczej po złamaniach i zabiegach ortopedycznych.

The Molski's clasp is used for fixation and proper positioning of the bones after pelvic fractures and surgical procedures.

Скоба Мольского используется для фиксации и правильного позиционирования тазовой кости после переломов и ортопедических операций.

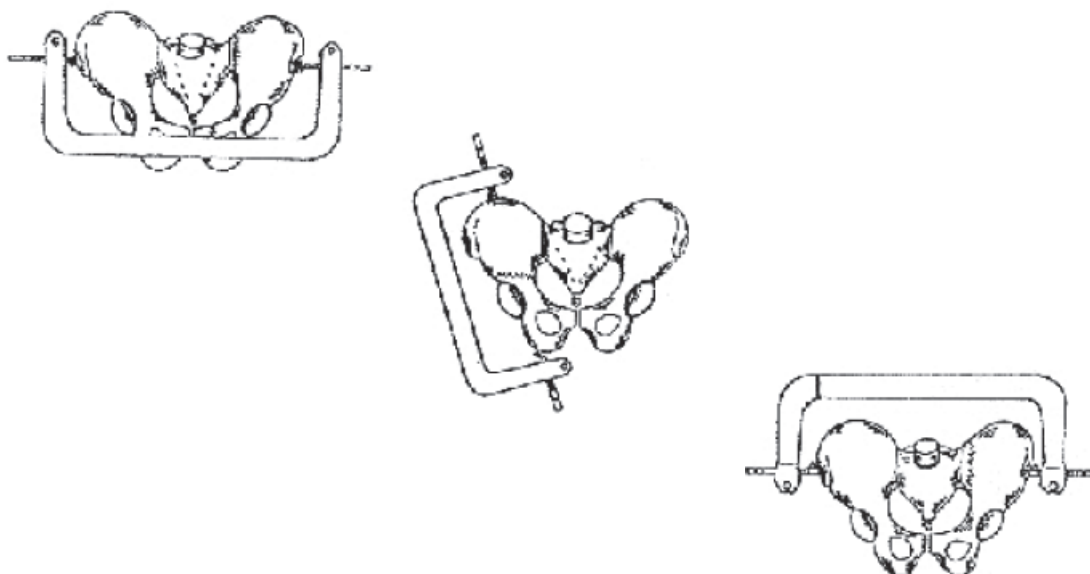



Ołowiana ręka
Lead hand
Свинцовая рука

30.4053

dla dzieci
for children
для детей

30.4054

dla dorosłych
for adults
для взрослых



Elektryczna piła oscylacyjna do cięcia opatrunków gipsowych

Electric plaster saw

Электрическая осцилляционная пила для разреза гипса

Typ: EP2

40.5045.000

WAŻNE

Informujemy o wycofaniu z naszej oferty piły oscylacyjnej do gipsu oraz klucza płaskiego S11. Jednocześnie w dalszym ciągu zapewniamy niezbędny serwis oraz dostęp do wyposażenia dodatkowego w postaci ostrzy.



Klucz płaski S11

Open-end wrench S11

Ключ S11

Wyposażenie dodatkowe

Additional equipment

Аксессуары

Ostrza wymienne

Saw blades

Заменные лезвия

40.0280 Ø50 mm

40.0281 Ø65 mm

Do gipsu syntetycznego

For synthetic plaster

Для синтетического гипса

40.0288 Ø50 mm

40.0289 Ø65 mm



do gipsu syntetycznego • for synthetic plaster • для синтетического гипса

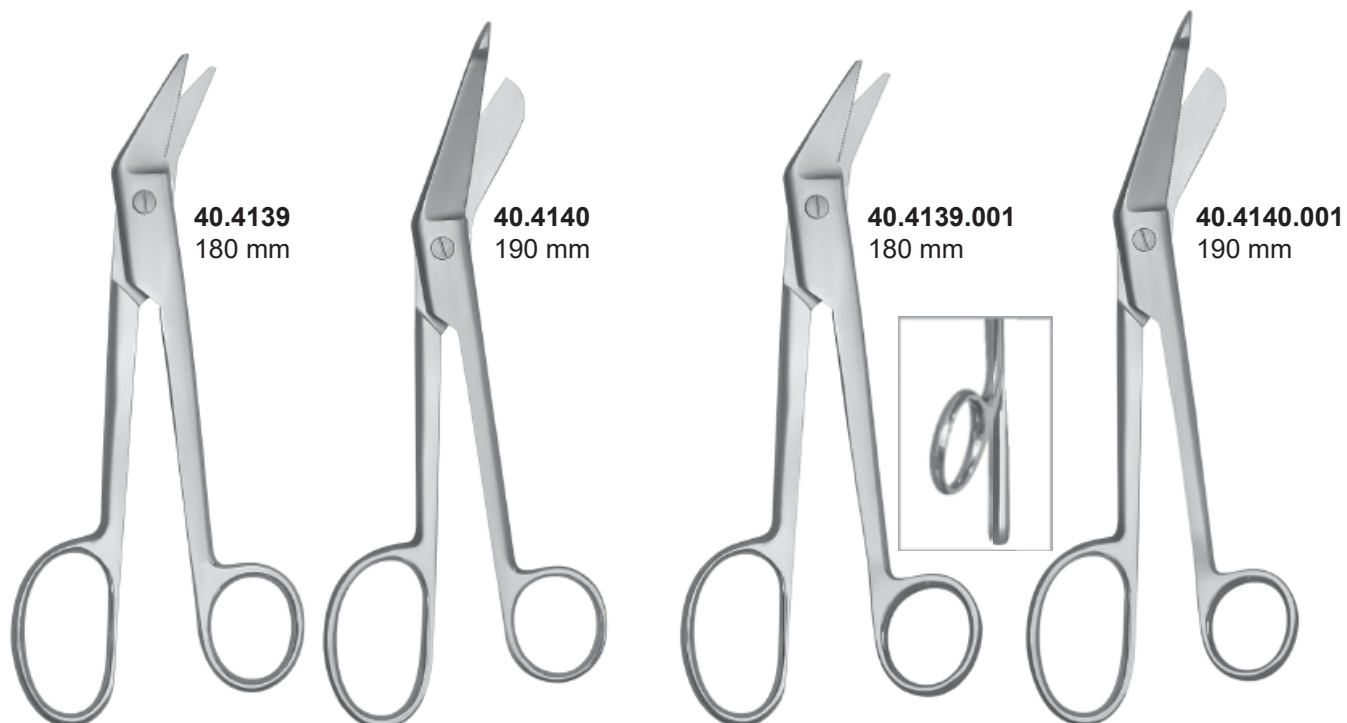

utwardzane ostrza • hardened edges • упрочненные лезвия



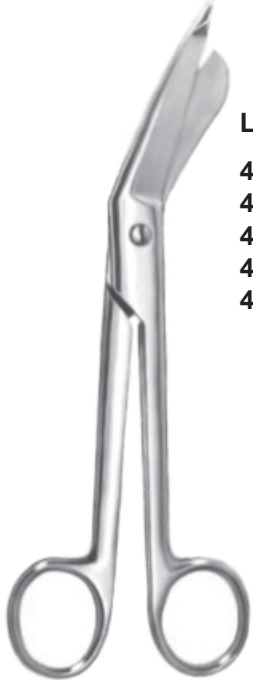

Lister

- 40.4141** 90 mm
- 40.4142** 110 mm
- 40.4143** 140 mm
- 40.4144** 180 mm
- 40.4145** 200 mm



Lister

- 30.2505.140** 140 mm
- 30.2505.000** 180 mm
- 30.2505.200** 200 mm
- utwardzane ostrza
- hardened edges
- упрочненные лезвия



Lister

- 40.4144.001** 180 mm
- 40.4145.001** 200 mm

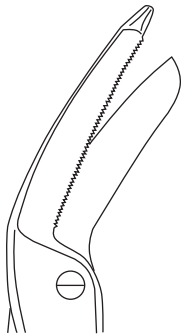

Lister (Excentric)

- 40.3264** 160 mm
- 40.3265** 190 mm

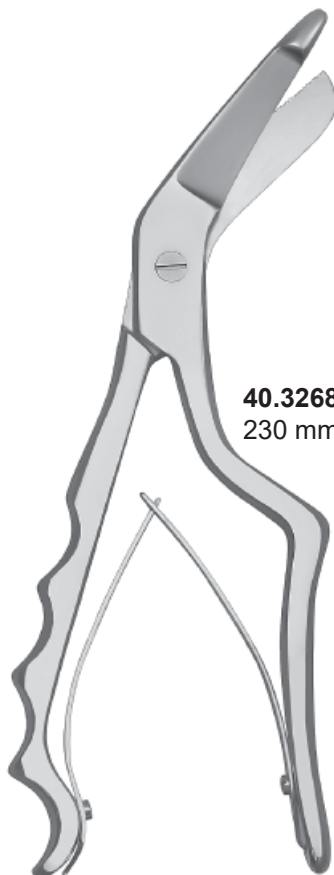

- 40.3268**
230 mm

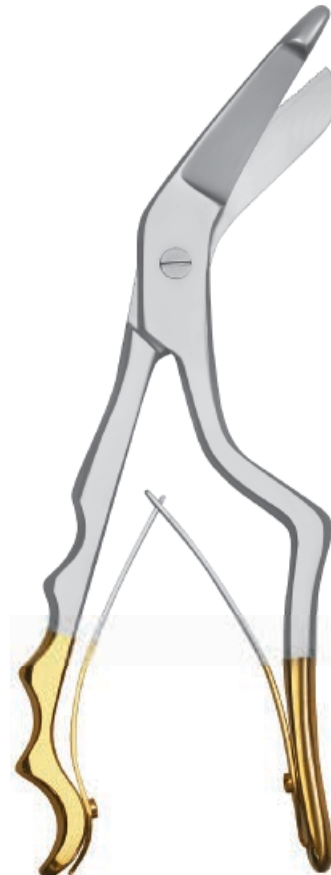

- 40.3269**
230 mm
- utwardzane ostrza
- hardened edges
- упрочненные лезвия



Lister
 40.4143.200 140 mm
 40.4144.200 180 mm
 40.4145.200 200 mm

Lister
 40.4145.201 200 mm

Lister (Excentric)
 40.3264.200 160 mm
 utwardzane ostrza
 hardened edges
 упрочненные лезвия

supercut • jedno ostrze tnące, drugie mikro-ząbkowane • with knife edge and micro-serrated edge • с одним лезвием режущим, другим микрозубчатым

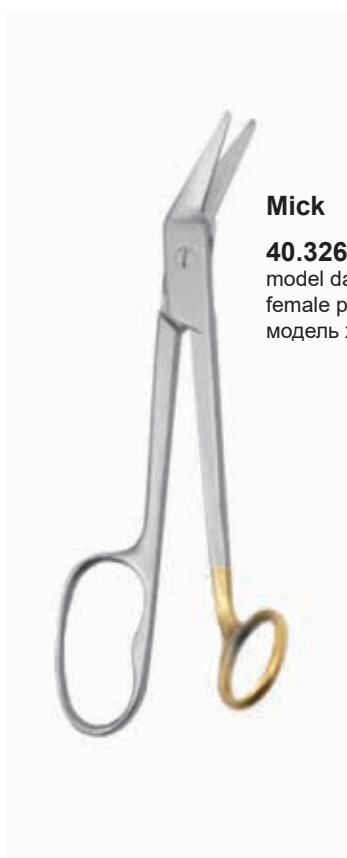

Mick
 40.3266 175 mm
 model damski
 female pattern
 модель женская

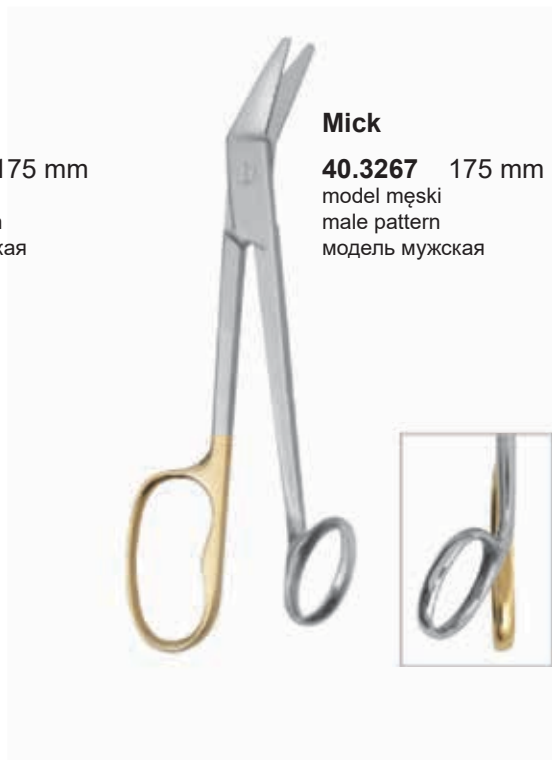

Mick
 40.3267 175 mm
 model męski
 male pattern
 модель мужская



Esmarch

40.3284 200 mm
40.3285 230 mm



Seutin

40.3286
230 mm



Bruns

40.3287
235 mm



Stille

40.3278 230 mm
40.3279 260 mm
40.3283 370 mm

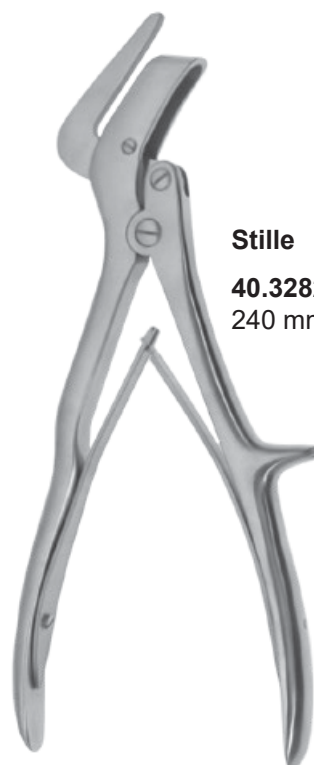

Stille

40.3282
240 mm



Haglund-Stille

40.0544
280 mm



Wolf

40.0546 180 mm
40.0547 240 mm



Henning

40.3290
280 mm



Esmarch

40.0120
180 mm



Hopkins

40.3291
200 mm



Reiner

40.3292
185 mm



Engel

40.3293

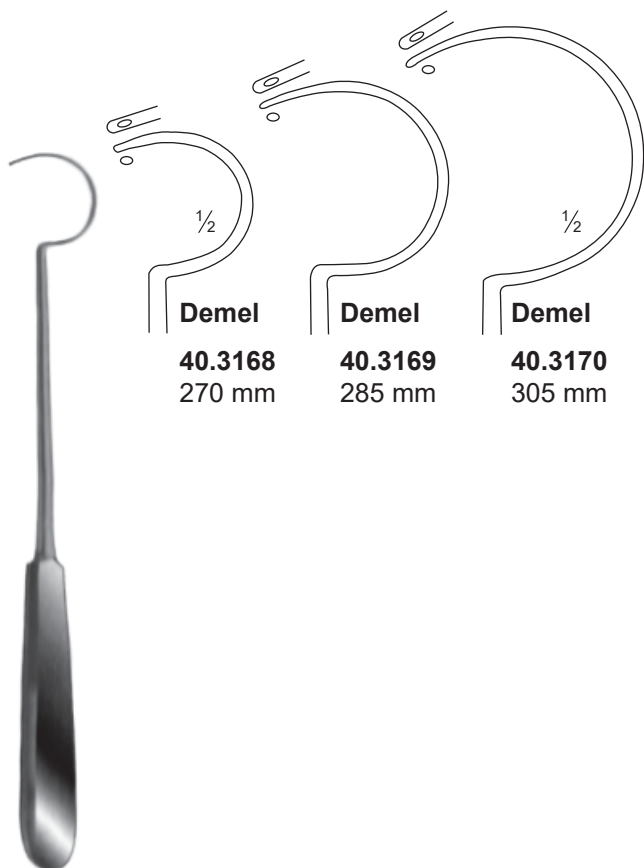

Demel
40.3168
270 mm

Demel
40.3169
285 mm

Demel
40.3170
305 mm



Demel
40.3171
240 mm



Demel
40.3172
270 mm



40.0434
190 mm
Ø max 1,2 mm
Przyrząd do zaciągania drutu
z pomiarem siły naciągu
Wire tensioning instrument with
measurement of tension force
Прибор для затяжки проволоки
с измерителем силы натяжения



Loute
40.0433
220 mm
Ø max 1 mm
Przyrząd do zaciągania drutu
Wire tightener
Прибор для затяжки проволоки



30.4130
280 mm
Przyrząd do
zaciągania drutu
Wire tightener
Прибор для
затяжки
проволоки

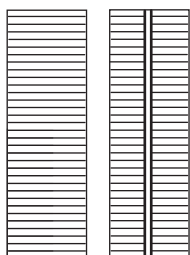

40.3194
180 mm



40.3195
180 mm
z cięciem bocznym
with side cutter
с боковым резцом
Ø 1,6 mm



40.3198
220 mm
z pobijakiem
with mallet
с молотком



40.3196.180 180 mm
40.3196.200 200 mm
40.3196.240 240 mm

z regulowanym
zaciskiem
with regulating screw
с регулирующим винтом

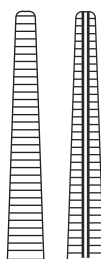

40.3197.220 220 mm
40.3197.250 250 mm
40.3197.300 300 mm

z regulowanym
zaciskiem
with regulating screw
с регулирующим винтом



40.3185
170 mm



40.3186
170 mm



40.4443
190 mm



30.4223
180 mm



30.4220

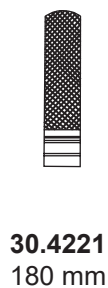

30.4221
180 mm

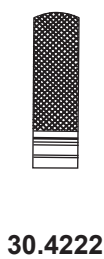

30.4222



30.4220.100



30.4221.100
180 mm



30.4222.100

utwardzane ostrza
hardened edges
упрочненные лезвия



40.4445
140 mm
tępe
blunt
тупые

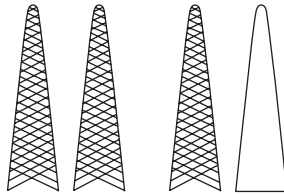

40.4444
140 mm
ostre
sharp
острые

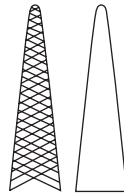

40.4444.100
140 mm
ostre
sharp
острые

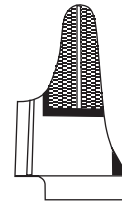

40.7248
150 mm

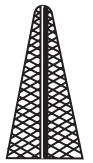

40.7249
160 mm



40.7250
140 mm
max Ø 1,5 mm
drut miękki
soft wire
мягкая проволока

max Ø 1 mm
drut twardy
hard wire
твердая проволока
utwardzane ostrza
hardened edges
упрочненные лезвия

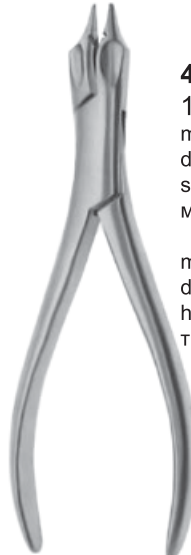

40.7251
150 mm
max Ø 1,5 mm
drut miękki
soft wire
мягкая проволока

max Ø 1 mm
drut twardy
hard wire
твердая проволока



40.7252
160 mm
max Ø 1,5 mm
drut miękki
soft wire
мягкая проволока

max Ø 1,2 mm
drut twardy
hard wire
твердая проволока



40.3180
150 mm

utwardzane ostrza
hardened edges
упрочненные лезвия

max Ø 2 mm
drut miękki
soft wire
мягкая проволока

max Ø 1,5 mm
drut twardy
hard wire
твердая проволока



30.4225
210 mm

utwardzane ostrza
hardened edges
упрочненные лезвия

max Ø 3 mm
drut miękki
soft wire
мягкая проволока

max Ø 2,5 mm
drut twardy
hard wire
твердая проволока



40.3176
230 mm

utwardzane ostrza
hardened edges
упрочненные лезвия

max Ø 3 mm
drut miękki
soft wire
мягкая проволока

max Ø 2,2 mm
drut twardy
hard wire
твердая проволока

40.3176.160
160 mm

utwardzane ostrza
hardened edges
упрочненные лезвия

max Ø 2 mm
drut miękki
soft wire
мягкая проволока

max Ø 1,5 mm
drut twardy
hard wire
твердая проволока



40.0275
160 mm

max Ø 2,2 mm
drut miękki
soft wire
мягкая проволока

max Ø 2 mm
drut twardy
hard wire
твердая проволока



40.7253
240 mm

max Ø 3 mm
drut miękki
soft wire
мягкая проволока

max Ø 2,7 mm
drut twardy
hard wire
твердая проволока



40.7253.100
240 mm

otwór tnący
cutting slot
режущее отверстие
Ø 3 mm

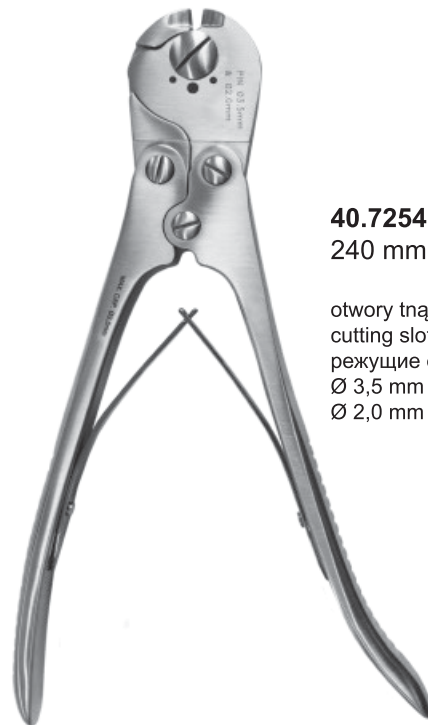

40.7254
240 mm

otwory tnące
cutting slots
режущие отверстия
Ø 3,5 mm
Ø 2,0 mm



40.3175
480 mm

max Ø 6 mm
do cięcia gwoździ
nail cutting
для стержней



40.3177
470 mm

max Ø 6 mm
do cięcia gwoździ
nail cutting
для стержней

odłączane rączki
removable handles
съёмные ручки

wymagają użycia ponad 40% mniej siły
wymienne utwardzane ostrza
wymienne gumowe szczęki
w całości nadające się do sterylizacji

over 40% less power required
exchangeable TC-blades
exchangeable rubber jaws
fully sterilisable

требуют сверх 40% меньше силы
заменяемые упрочненные лезвия
заменяемые резиновые губки
можно стерилизовать целиком



Hercules
30.4169
150 mm
max Ø 1,6 mm



Hercules
30.4171
180 mm
max Ø 2,2 mm



Hercules
30.4174
180 mm
max Ø 2,2 mm



Hercules
30.4172
230 mm
max Ø 3 mm



Hercules
30.4173
280 mm
Ø 2,5-3,5 mm



Hercules
30.4175
180 mm
max Ø 1-2 mm

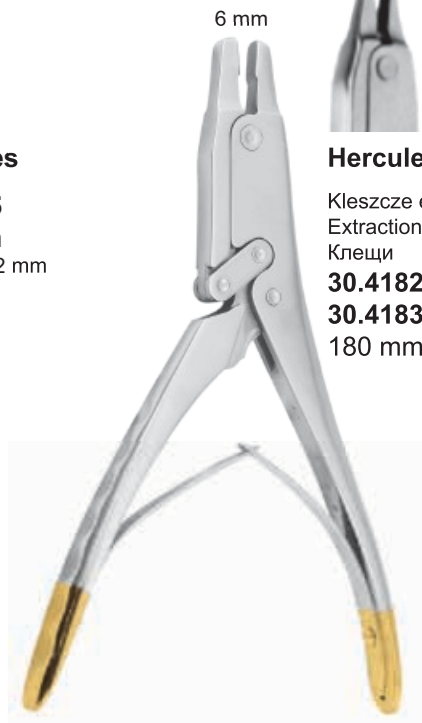

3 mm
6 mm
Hercules
Kleszce ekstrakcyjne
Extraction forceps
Клеши
30.4182 3mm
30.4183 6mm
180 mm



Hercules
30.4183.100
180 mm
max Ø 2.0 mm

części zapasowe
spare parts
запасные части

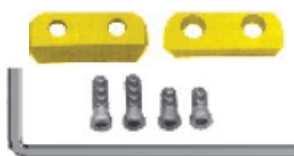

30.4176 Kompatybilne z • fits to • сочетаемый с 30.4171/ 30.4174
30.4177 Kompatybilne z • fits to • сочетаемый с 30.4172
30.4178 Kompatybilne z • fits to • сочетаемый с 30.4173



30.4181 Kompatybilne z • fits to • сочетаемый с 30.4175



30.4180 Kompatybilne z • fits to • сочетаемый с 30.4169/ 30.4183.100



30.4179 Kompatybilne z • fits to • сочетаемый с 30.4171/ 30.4172/ 30.4173/ 30.4174
30.4179.100 Kompatybilne z • fits to • сочетаемый с 30.4169/ 30.4183.100

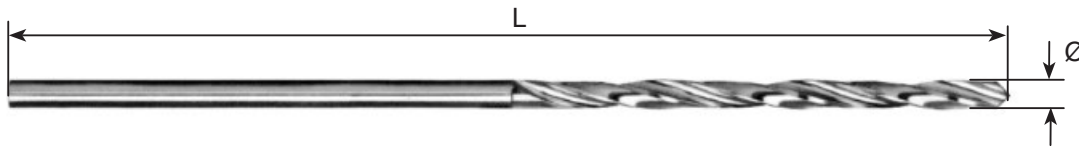

Ø [mm]	L [mm]						
	80	100	150	180	250	300	350
1,0	40.2045	-	-	-	-	-	-
1,5	-	40.2046	-	-	-	-	-
1,8	-	40.2063	-	-	-	-	-
2,0	-	-	40.2047	-	-	-	-
2,2	-	-	40.2048	-	-	-	-
2,5	-	-	40.2049	-	-	40.2135	-
2,8	-	-	40.2050	40.2044	-	-	-
3,0	-	-	40.2051	-	40.2052	-	-
3,2	-	-	-	40.0614	40.2053	-	-
3,5	-	-	40.1364	40.2137	40.1386	40.1363	-
3,7	-	-	40.2065	40.2136	40.2066	-	-
4,0	-	-	-	40.2054	-	40.2055	-
4,5	-	-	40.1388	40.0615	40.1387	40.2056	40.2138
4,7	-	-	-	40.2064	-	-	-
5,0	-	-	-	40.2057	40.1365	40.2058	-
5,5	-	-	-	40.2059	-	40.2060	-
6,0	-	-	-	40.2061	40.2069	40.2062	-
6,5	-	-	-	-	-	40.2068	-

Kaniulowane

Cannulated

Канюлированные



Ø [mm]	d [mm]	L [mm]			
		150	180	200	300
2,5	1,2	40.2038.150	-	-	-
3,0	1,2	40.2036.150	-	-	-
3,2	1,2	40.2040.150	-	40.2040.200	-
3,5	1,2	40.2037.150	-	-	-
4,5	1,2	40.2041	-	-	-
5,0	1,2	-	40.1899	-	-
5,0	2,2	-	40.2043	-	-
6,0	2,2	40.4584	-	-	-
6,5	2,2	-	-	-	40.3674
7,0	2,5	-	-	40.1898	-
8,0	2,5	-	-	40.2042	-



Rączka Steinmanna

40.0987.200

Trójszczękowy, kaniulowany uchwyt samozaciskowy do mocowania drutów i gwoździ 0,3÷7,4 mm

3-jaw chuck, self-clamp, cannulated handle, for pins and wires 0,3÷7,4 mm

3-х кулачковый канюлированный самозажимной патрон для захвата спиц и стержней 0,3÷7,4 мм

Chwytek wkrętów 3,5mm - 6,5mm

40.7271

90 mm



Chwytek wkrętów 1,5mm - 2,7mm

40.7272

90 mm

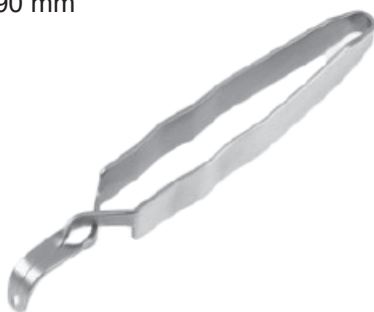

Gwintownik z rączką

Tap with T-handle

Ручный мечник

	Ø [mm]
40.2545	HA 1,5
40.2546	HA 2,0
40.2547	HA 2,7
40.2548	HA 3,5
40.2550	HA 4,5
40.2552	HB 3,5
40.2553	HB 4,0
40.2554	HB 6,5



Haczyk 155 mm

Sharp Hook

Острый Крючок

40.3599

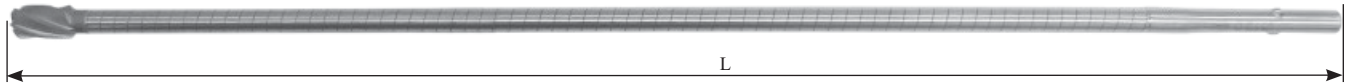

Len	DIN z nakrętką DIN with nut DIN с гайкой	DIN bez nakrętki DIN without nut DIN без гайки	AO	Harris	Hudson	Stryker / Zimmer / Trinkle	
							Nr katalogowy Catalogue no. № по кат.
6.0	390	40.5103.000	40.5103.100	40.5103.200	40.5103.300	40.5103.400	40.5103.500
6.5	390	40.5104.000	40.5104.100	40.5104.200	40.5104.300	40.5104.400	40.5104.500
7.0	390	40.4541.000	40.4541.100	40.4541.200	40.4541.300	40.4541.400	40.4541.500
7.5	390	40.5105.000	40.5105.100	40.5105.200	40.5105.300	40.5105.400	40.5105.500
8.0	480	40.4542.000	40.4542.100	40.4542.200	40.4542.300	40.4542.400	40.4542.500
8.5	480	40.5106.000	40.5106.100	40.5106.200	40.5106.300	40.5106.400	40.5106.500
9.0	480	40.4543.000	40.4543.100	40.4543.200	40.4543.300	40.4543.400	40.4543.500
9.5	480	40.5107.000	40.5107.100	40.5107.200	40.5107.300	40.5107.400	40.5107.500
10.0	480	40.4544.000	40.4544.100	40.4544.200	40.4544.300	40.4544.400	40.4544.500
10.5	480	40.5108.000	40.5108.100	40.5108.200	40.5108.300	40.5108.400	40.5108.500
11.0	480	40.4545.000	40.4545.100	40.4545.200	40.4545.300	40.4545.400	40.4545.500
11.5	480	40.5109.000	40.5109.100	40.5109.200	40.5109.300	40.5109.400	40.5109.500
12.0	480	40.4546.000	40.4546.100	40.4546.200	40.4546.300	40.4546.400	40.4546.500
12.5	480	40.5110.000	40.5110.100	40.5110.200	40.5110.300	40.5110.400	40.5110.500
13.0	480	40.4547.000	40.4547.100	40.4547.200	40.4547.300	40.4547.400	40.4547.500
13.5	480	40.5111.000	40.5111.100	40.5111.200	40.5111.300	40.5111.400	40.5111.500
14.0	480	40.4548.000	40.4548.100	40.4548.200	40.4548.300	40.4548.400	40.4548.500
14.5	480	40.5112.000	40.5112.100	40.5112.200	40.5112.300	40.5112.400	40.5112.500
15.0	480	40.5113.000	40.5113.100	40.5113.200	40.5113.300	40.5113.400	40.5113.500
15.5	480	40.5114.000	40.5114.100	40.5114.200	40.5114.300	40.5114.400	40.5114.500
16.0	480	40.5115.000	40.5115.100	40.5115.200	40.5115.300	40.5115.400	40.5115.500
16.5	480	40.5116.000	40.5116.100	40.5116.200	40.5116.300	40.5116.400	40.5116.500
17.0	480	40.5117.000	40.5117.100	40.5117.200	40.5117.300	40.5117.400	40.5117.500
17.5	480	40.5118.000	40.5118.100	40.5118.200	40.5118.300	40.5118.400	40.5118.500
18.0	480	40.5119.000	40.5119.100	40.5119.200	40.5119.300	40.5119.400	40.5119.500

dostępne typy zamocowań • available connections • доступные типы соединений

40.xxxx.000



DIN with coupling nut

40.xxxx.100



DIN without coupling nut

40.xxxx.200



AO

40.xxxx.300



Harris

40.xxxx.400



Hudson

40.xxxx.500





Stryker / Zimmer / Trinkle

NOWOŚĆ!



czołowy
leading
передовое



		DIN	AO	Harris	Stryker/Zimmer/Trinkle
		Nr katalogowy Catalogue no. № по кат.	Nr katalogowy Catalogue no. № по кат.	Nr katalogowy Catalogue no. № по кат.	Nr katalogowy Catalogue no. № по кат.
8.0	480	40.4542.110	40.4542.210	40.4542.310	40.4542.510
8.5	480	40.5106.110	40.5106.210	40.5106.310	40.5106.510
9.0	480	40.4543.110	40.4543.210	40.4543.310	40.4543.510
9.5	480	40.5107.110	40.5107.210	40.5107.310	40.5107.510
10.0	480	40.4544.110	40.4544.210	40.4544.310	40.4544.510
10.5	480	40.5108.110	40.5108.210	40.5108.310	40.5108.510
11.0	480	40.4545.110	40.4545.210	40.4545.310	40.4545.510
11.5	480	40.5109.110	40.5109.210	40.5109.310	40.5109.510
12.0	480	40.4546.110	40.4546.210	40.4546.310	40.4546.510
12.5	480	40.5110.110	40.5110.210	40.5110.310	40.5110.510
13.0	480	40.4547.110	40.4547.210	40.4547.310	40.4547.510
13.5	480	40.5111.110	40.5111.210	40.5111.310	40.5111.510
14.0	480	40.4548.110	40.4548.210	40.4548.310	40.4548.510
14.5	480	40.5112.110	40.5112.210	40.5112.310	40.5112.510
15.0	480	40.5113.110	40.5113.210	40.5113.310	40.5113.510
15.5	480	40.5114.110	40.5114.210	40.5114.310	40.5114.510
16.0	480	40.5115.110	40.5115.210	40.5115.310	40.5115.510
16.5	480	40.5116.110	40.5116.210	40.5116.310	40.5116.510
17.0	480	40.5117.110	40.5117.210	40.5117.310	40.5117.510
17.5	480	40.5118.110	40.5118.210	40.5118.310	40.5118.510
18.0	480	40.5119.110	40.5119.210	40.5119.310	40.5119.510

dostępne typy zamocowań • available connections • доступные типы соединений

40.xxxx.110



DIN

40.xxxx.210



AO

40.xxxx.310



Harris

40.xxxx.510



Stryker/Zimmer/Trinkle



Statyw na rozwiertaki
(komplet z kontenerem)
Stand for reamers (set with container)
Подставка для интрамедуллярных свёрл
(комплект с контейнером)
40.5762.200

Wkładka statywu na rozwiertaki
(tylko taca wewnętrzna)
Stand insert for reamers
(internal tray only)
Вкладыш для подставки для
интрамедуллярных свёрл
(только внутренний поднос)
40.5762.300



Prowadnica ochronna
Protective guide
Направитель-протектор
40.6375



Pokrętko
Hand
Рукоятка
40.3232

Drut prowadzący
Guide rod
Спица-направитель



	Len	D	Nr katalogowy Catalogue no. № по кат.
1.8	600	4	40.4749.600
2.5	500	5	40.4747.500
3.0	700	5	40.3929.000
2.5	1000	4	40.1350.000
3.0	1000	5	40.3929.001

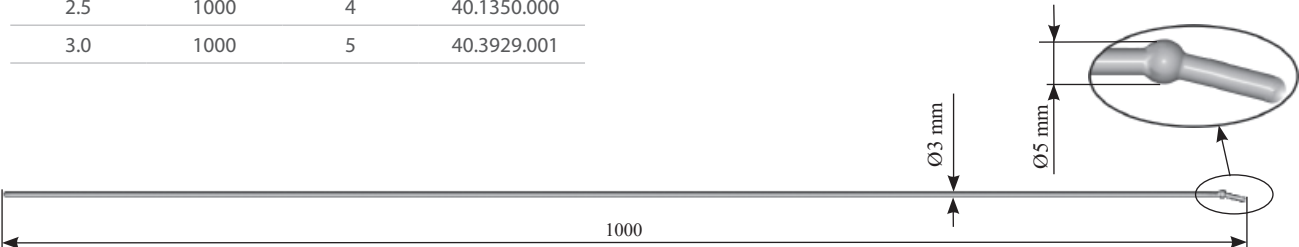

	Len	D	Nr katalogowy Catalogue no. № по кат.
3.0	1000	5	40.3930.000

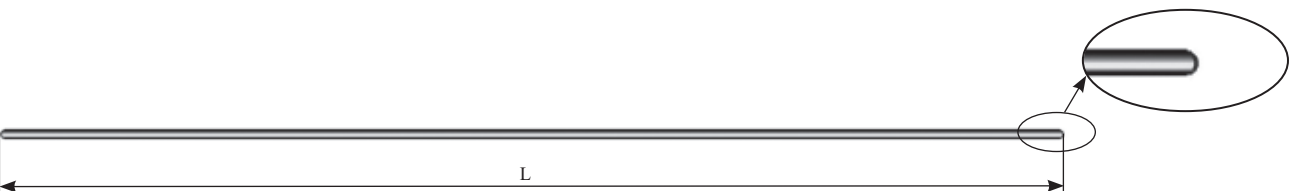

	Len	Nr katalogowy Catalogue no. № по кат.
3.0	600	40.3925.000
3.5	600	40.3926.000
4.0	600	40.3927.000
5.0	600	40.3928.000



Prasa do gięcia płytek prostych i kątowych o grubości do 3,2 mm

Bending press for straight and angular plates up to 3.2 mm

Гибочный пресс для прямых и угловых костных пластин до 3,2 мм

40.3694 30 cm



Prasa do gięcia płytek prostych i kątowych o grubości do 6 mm

Bending press for straight and angular plates up to 6 mm

Гибочный пресс для прямых и угловых костных пластин до 6 мм

40.3695 43 cm



Szczypce do gięcia płytek drobnych i cienkich o grubości do 1,6 mm

Bending forceps for small and thin plates up to 1,6 mm

Гибочные клещи для мелких и тонких пластин до 1,6 мм

40.3570 20 cm



Kleszcze do gięcia płytek prostych o grubości do 3,2 mm

Bending forceps for straight plates up to 3.2 mm

Гибочный пресс для прямых костных пластин до 3,2 мм

40.4245

Szczypce do gięcia dużych płytek o grubości do 3 mm

Bending forceps for big plates up to 3 mm

Гибочные клещи для пластин до 3 мм

40.4246 24 cm



40.4250

Zaginak 4 mm i 6 mm, używany w parach

Bender 4 mm and 6 mm, used in pairs

Сгибатель 4 мм и 6 мм, используются в паре



40.4248
150 mm



40.4249
150 mm

Zaginaki do płytek drobnych, szerokość szczelin 2,5 mm i 4 mm, używane w parze

Benders for small plates, width of slots 2.5mm and 4 mm, used in pairs

Сгибатели для мелких пластин, ширина зазора 2,5 и 4 мм, используются в паре



40.4251

Zaginak do płytek cienkich

Bender for thin plates

Сгибатель для мелких пластин



Mannerfelt
30.0740.001
 135 mm



Mannerfelt
30.0740.002
 155 mm



Mannerfelt
30.0741.000
 155 mm



Mannerfelt
30.0742.001 8 mm x 12.5 mm
30.0742.002 10 mm x 21.5 mm
 155 mm



Mannerfelt
 155 mm



30.0743.001



ostre • sharp • острые

30.0743.002



30.0743.003



30.0744.001

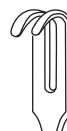





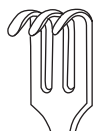











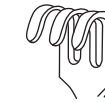

tępe • blunt • тупые

30.0744.002



30.0744.003

		8 x 8 mm 	7 x 11 mm 		4 x 7.2 mm 	16 x 6 mm 
	30.0745.001	30.0745.002	30.0745.003			
	ostre • sharp • острые					
		8 x 8 mm 	7 x 11 mm 			
	30.0746.001	30.0746.002	30.0746.003			
	tępe • blunt • тупые					
Mannerfelt 155 mm						

		Mannerfelt				Mannerfelt				Mannerfelt				Mannerfelt
	30.0749.001	15 x 6 mm	30.0750.001		12 x 12 mm	30.0751.000	155 mm		30.0752.000	160 mm				
	30.0749.002	20 x 6 mm	30.0750.002		12 x 14 mm									
	30.0749.003	25 x 6 mm	30.0750.003		12 x 16 mm									
30.0749.004	30 x 6 mm		155 mm											
155 mm														

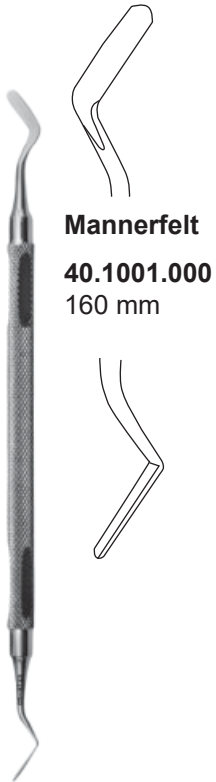

Mannerfelt
40.1001.000
 160 mm



Freer
40.1002.001 6 mm
 tępa
 blunt
 тупой
40.1002.002 5 mm
 ostra
 sharp
 острый

Freer
 190 mm

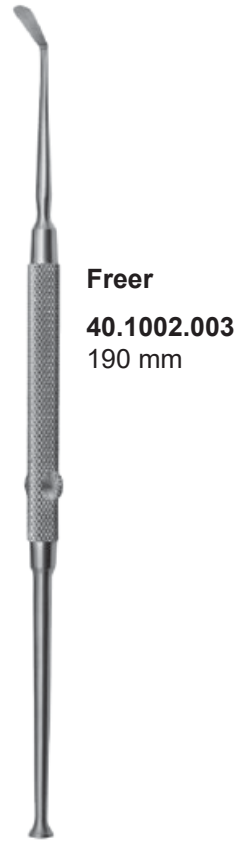

Freer
40.1002.003
 190 mm



Freer -Yasargil
40.1003.000
 185 mm

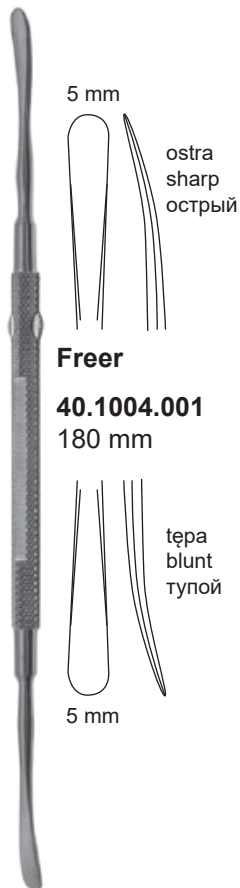
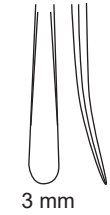

5 mm
 ostra
 sharp
 острый
Freer
40.1004.001
 180 mm

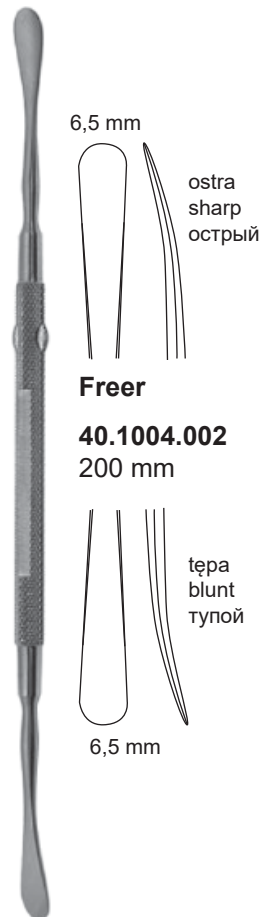
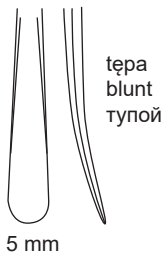

6,5 mm
 ostra
 sharp
 острый
Freer
40.1004.002
 200 mm

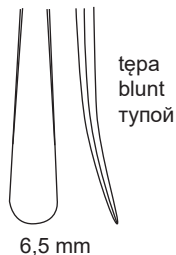

Freer - Joseph
40.1005.000
 200 mm

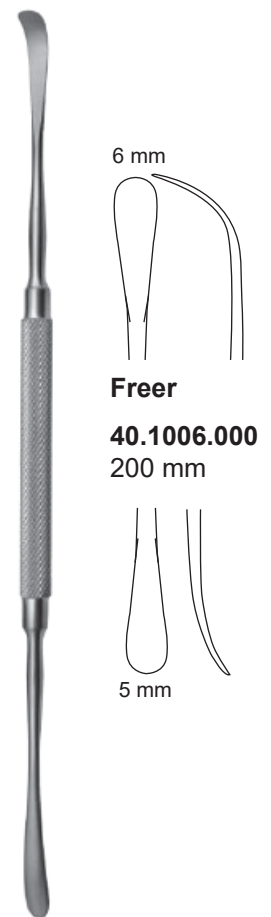

6 mm
Freer
40.1006.000
 200 mm

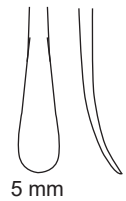

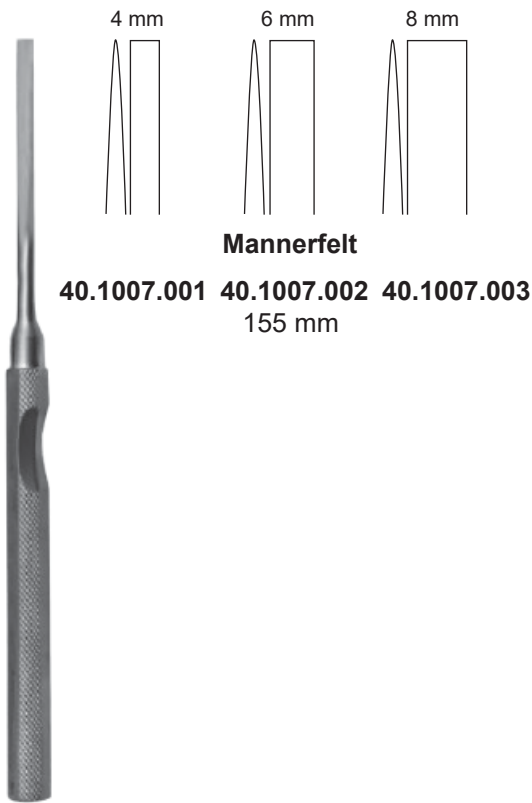

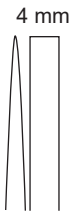
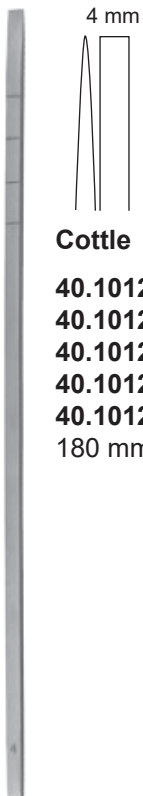

Cottle

- 40.1012.004** 4 mm
- 40.1012.006** 6 mm
- 40.1012.008** 8 mm
- 40.1012.010** 10 mm
- 40.1012.012** 12 mm
- 180 mm

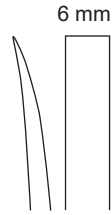
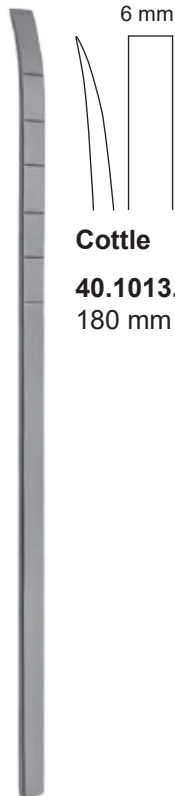

Cottle

- 40.1013.000**
- 180 mm

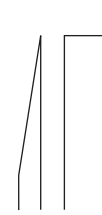
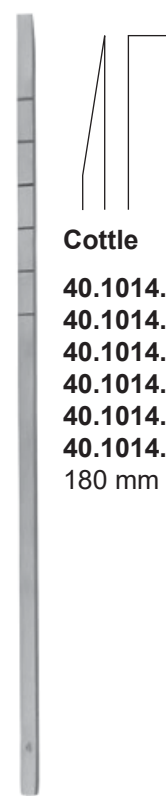

Cottle

- 40.1014.004** 4 mm
- 40.1014.005** 5 mm
- 40.1014.006** 6 mm
- 40.1014.007** 7 mm
- 40.1014.009** 9 mm
- 40.1014.012** 12 mm
- 180 mm

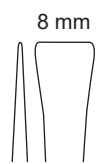

Cottle Fishtail

- 40.1015.008**
- 180 mm

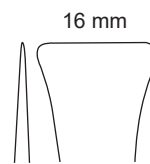

Cottle Fishtail

- 40.1015.016**
- 180 mm



Weitlaner-Loktite

30.1460 130 mm

30.1462 165 mm

30.1464 200 mm

ostrzy
sharp
острый

30.1461 130 mm

30.1463 165 mm

30.1465 200 mm

tępy
blunt
тупой



Weitlaner-Wullstein

30.1466 130 mm

ostrzy
sharp
острый

30.1467 130 mm

tępy
blunt
тупой



Cone

30.1471 130 mm

30.1473 165 mm

30.1475 200 mm

30.1477 250 mm

ostrzy
sharp
острый

30.1472 130 mm

30.1474 165 mm

30.1476 200 mm

30.1478 250 mm

tępy
blunt
тупой



Milligan

30.1482.000 130 mm

tępy
blunt
тупой

30.1482.100 130 mm

ostrzy
sharp
острый



Mollison

30.1484
155 mm



Adson-Baby

30.1485
160 mm
tępy
blunt
тупой

30.1486
160 mm
ostry
sharp
острый

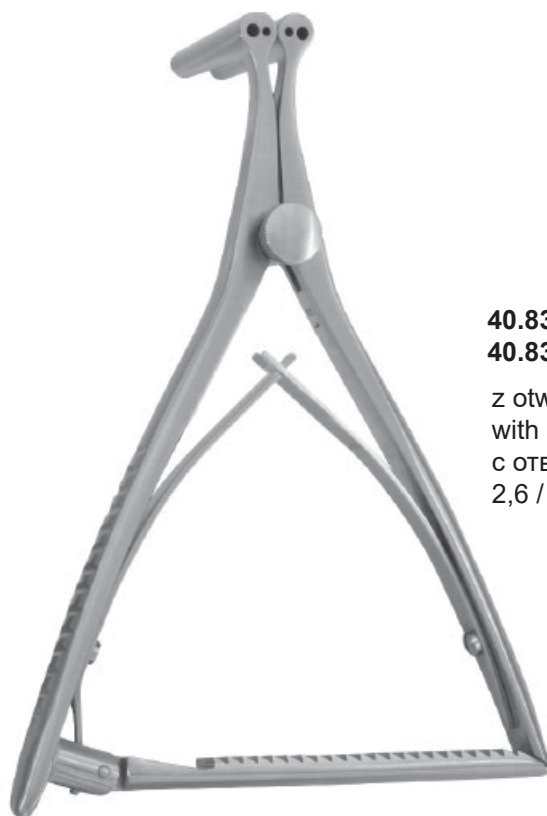

40.8395.150 15 cm max. dystrakcja 32 mm
40.8395.205 20,5 cm max. dystrakcja 44 mm

z otworami
with holes
с отверстиями
2,6 / 1,7mm



40.8396.150 15 cm max. dystrakcja 55 mm
40.8396.205 20,5 cm max. dystrakcja 62 mm

z otworami
with holes
с отверстиями
2,6 / 1,7mm

6x10 mm



Łyżeczka kostna
Bone curette
Костная ложка
40.7210
355mm



Ekstraktor
Extractor
Экстрактор
40.4783
270 mm



Łyżka Murphy-Lane
Murphy-Lane bone skid
Ложка Murphy-Lane
40.7208.030 30/19 mm
310 mm



40.7216
230 mm



Hak do ekstrakcji cementu kostnego
Hook for bone cement extraction
Крючок для экстракции костного цемента
40.7211
300 mm

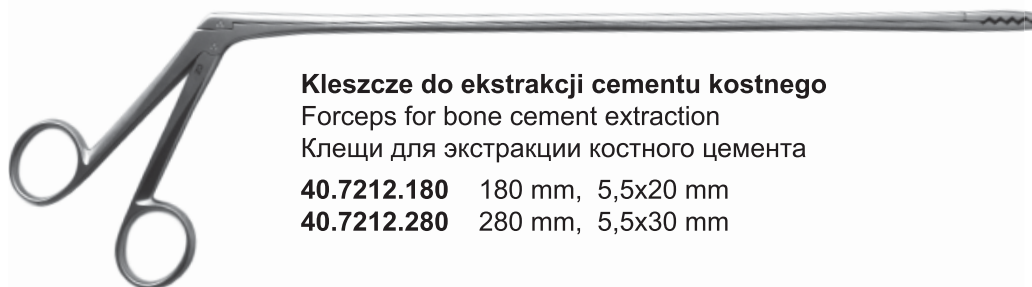

Kleszcze do ekstrakcji cementu kostnego
Forceps for bone cement extraction
Клещи для экстракции костного цемента
40.7212.180 180 mm, 5,5x20 mm
40.7212.280 280 mm, 5,5x30 mm



Resano
40.7217
250 mm
ostro-tępe
sharp/blunt
остро/тупые

40.7218
250 mm
tępe
blunt
тупые



Ferris-Smith-Kerrison



			Model nierozbieralny Regular pattern Неразборный тип		Model rozbieralny Dismountable pattern Разборный тип	
			18 cm	20 cm	18 cm	20 cm
1 mm	90°		40.4265	40.4267	40.4285	40.4291
2 mm			40.4266	40.4268	40.4286	40.4292
3 mm			40.2290	40.2295	40.4287	40.4293
4 mm			40.2291	40.2296	40.4288	40.4294
5 mm			40.2292	40.2297	40.4289	40.4295
6 mm			40.2293	40.2298	40.4290	40.4296
1 mm	40°		40.4269	40.4271	40.4297	40.4303
2 mm			40.4270	40.4272	40.4298	40.4304
3 mm			40.2305	40.2310	40.4299	40.4305
4 mm			40.2306	40.2311	40.4300	40.4306
5 mm			40.2307	40.2312	40.4301	40.4307
6 mm			40.2308	40.2313	40.4302	40.4308
1 mm	90°		40.4273	40.4279		
2 mm			40.4274	40.4280		
3 mm			40.4275	40.4281		
4 mm			40.4276	40.4282		
5 mm			40.4277	40.4283		
6 mm			40.4278	40.4284		

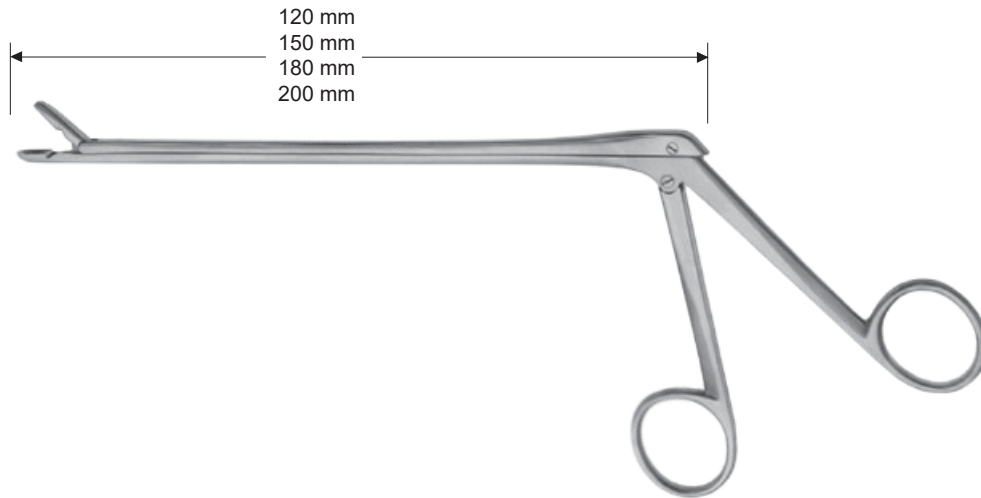

Cushing
2 x 10 mm



L=120 mm **40.4334**
 L=150 mm **40.4335**
 L=180 mm **40.4336**
 L=200 mm **40.4337**



45°

L=120 mm **40.4338**
 L=150 mm **40.4339**
 L=180 mm **40.4340**
 L=200 mm **40.4341**



45°

L=120 mm **40.4342**
 L=150 mm **40.4343**
 L=180 mm **40.4344**
 L=200 mm **40.4345**

Gruenwald
3 x 10 mm



L=120 mm **40.4346**
 L=150 mm **40.4347**
 L=180 mm **40.4348**
 L=200 mm **40.4349**

L=120 mm **40.4350**
 L=150 mm **40.4351**
 L=180 mm **40.4352**
 L=200 mm **40.4353**

L=120 mm **40.4354**
 L=150 mm **40.4355**
 L=180 mm **40.4356**
 L=200 mm **40.4357**

Spurling
4 x 10 mm





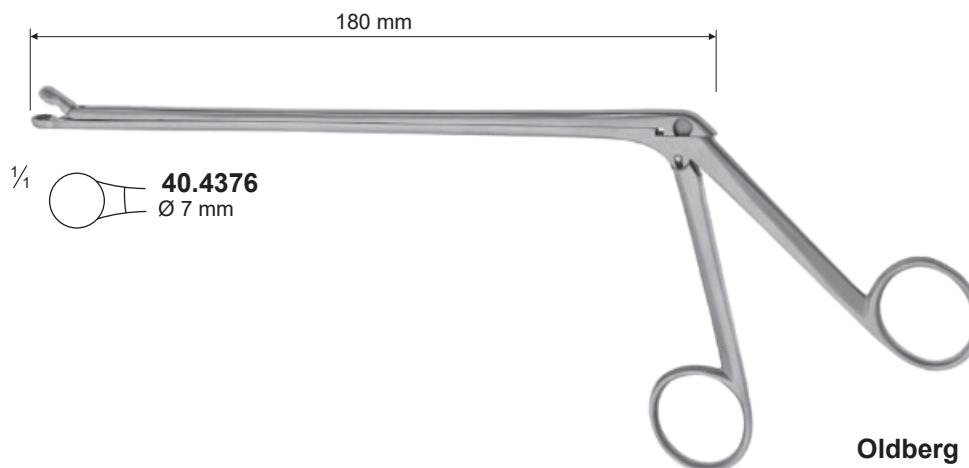
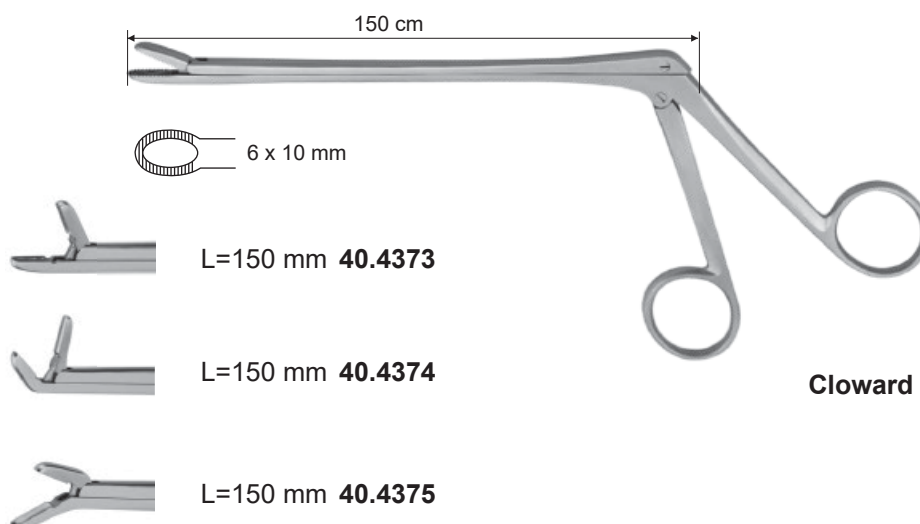
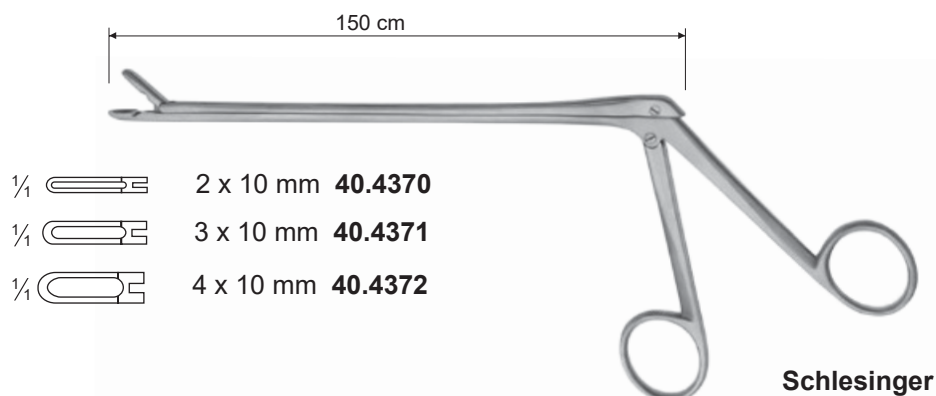

L=120 mm **40.4358**
 L=150 mm **40.4359**
 L=180 mm **40.4360**
 L=200 mm **40.4361**

L=120 mm **40.4362**
 L=150 mm **40.4363**
 L=180 mm **40.4364**
 L=200 mm **40.4365**

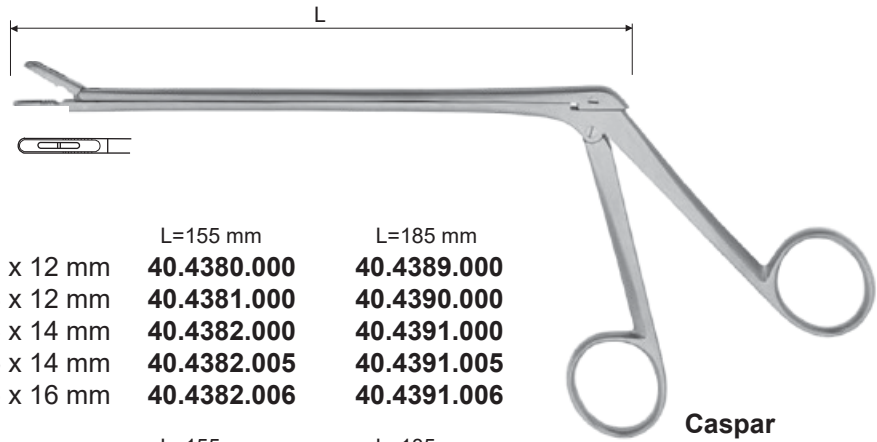
L=120 mm **40.4366**
 L=150 mm **40.4367**
 L=180 mm **40.4368**
 L=200 mm **40.4369**





	L=155 mm	L=185 mm
	2 x 12 mm 40.4380.000	40.4389.000
	3 x 12 mm 40.4381.000	40.4390.000
	4 x 14 mm 40.4382.000	40.4391.000
	5 x 14 mm 40.4382.005	40.4391.005
	6 x 16 mm 40.4382.006	40.4391.006
	L=155 mm	L=185 mm
	3 x 12 mm 40.4384.000	40.4393.000
	4 x 14 mm 40.4385.000	40.4394.000
	5 x 14 mm 40.4385.005	40.4394.005
	L=155 mm	L=185 mm
	3 x 12 mm 40.4387.000	40.4396.000
	4 x 14 mm 40.4388.000	40.4397.000

Caspar

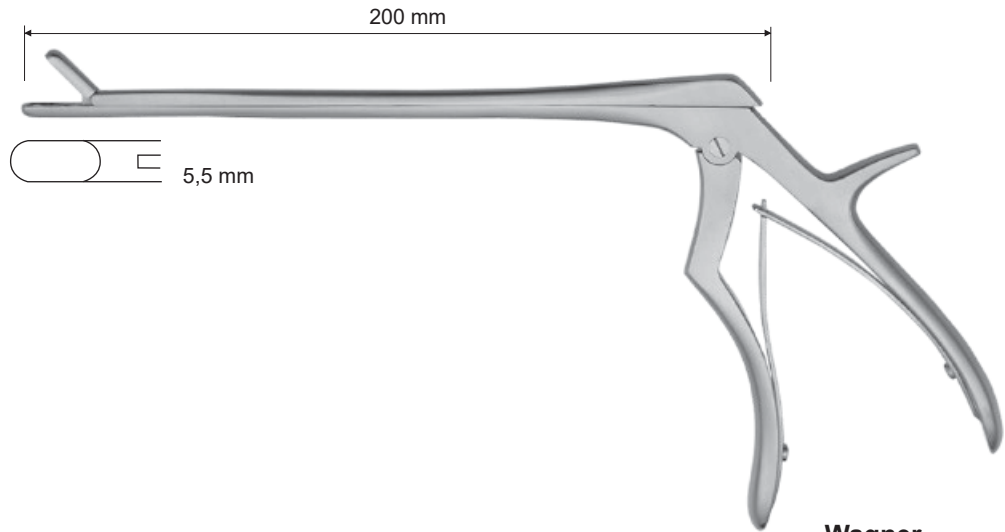

Wagner

40.4398

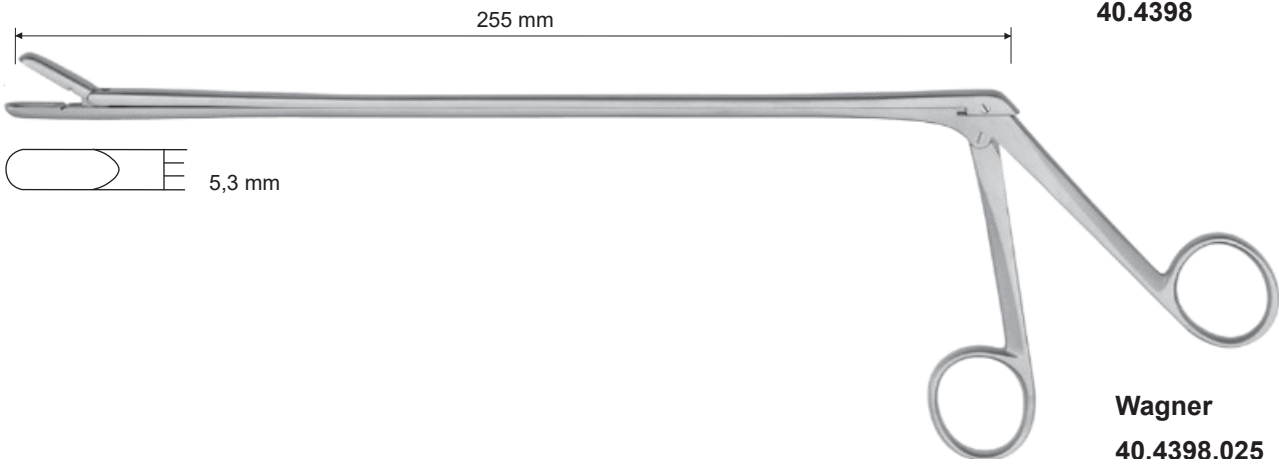

Wagner

40.4398.025

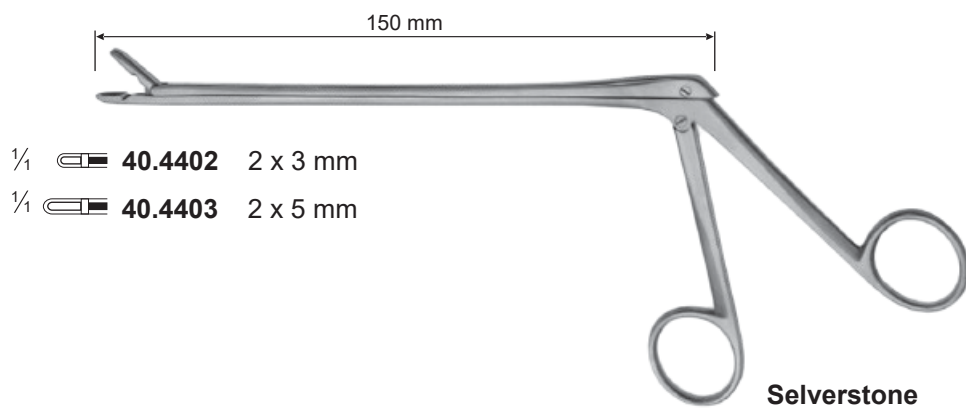
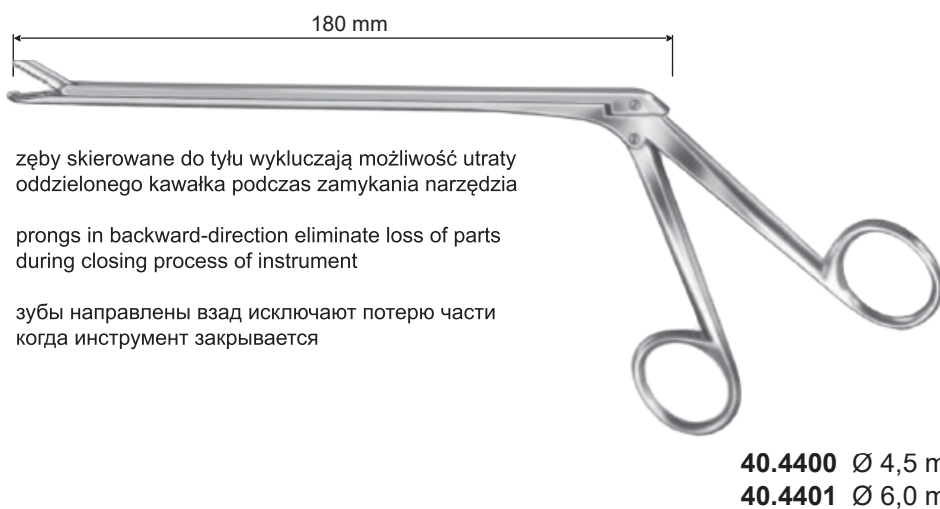
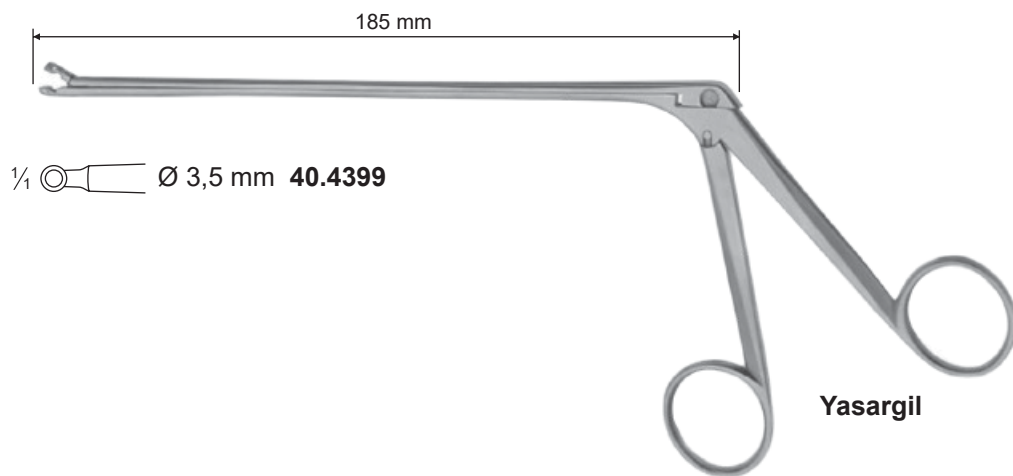

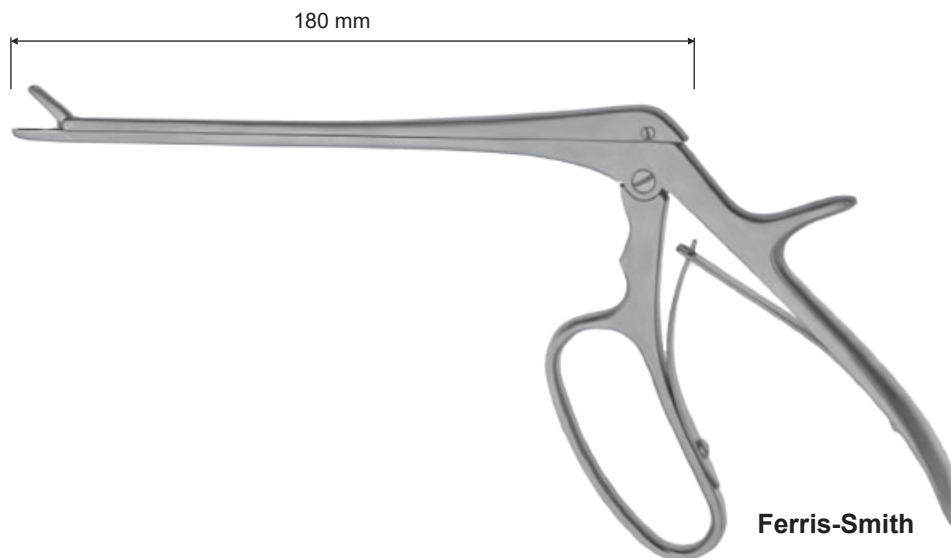

	2 x 10 mm	40.4407	40.4408	40.4409
	3 x 10 mm	40.4410	40.4411	40.4412
	4 x 10 mm	40.4413	40.4414	40.4415
	5 x 10 mm	40.7240	40.7241	40.7242
	6 x 10 mm	40.4416	40.4417	40.4418



Cloward
40.1390
150 mm



Cloward
40.1391
160 mm



4,5 mm **Cloward**
40.1395
135 mm



Inge
40.1392
170 mm

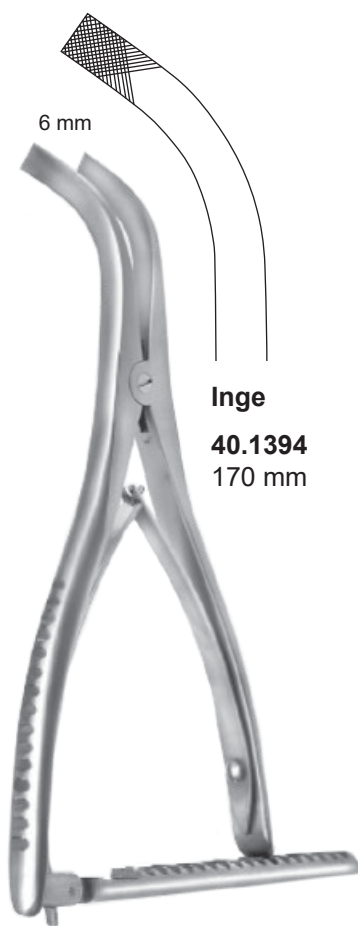

Inge
40.1394
170 mm



Inge
40.1393.008 8 mm
40.1393.012 12 mm
270 mm



30.4082
220 mm



30.4083
195 mm
30.4084
225 mm



Gluck
30.4085
210 mm



Bethune
30.4086
340 mm



Giertz-Stille
30.4087
270 mm



Brunner
30.4088
dla praworęcznych
for the right-handed
для правшей
30.4089
dla leworęcznych
for the left-handed
для левшей
320 mm



Lebsche
30.4092
250 mm



Lebsche
30.4093
245 mm

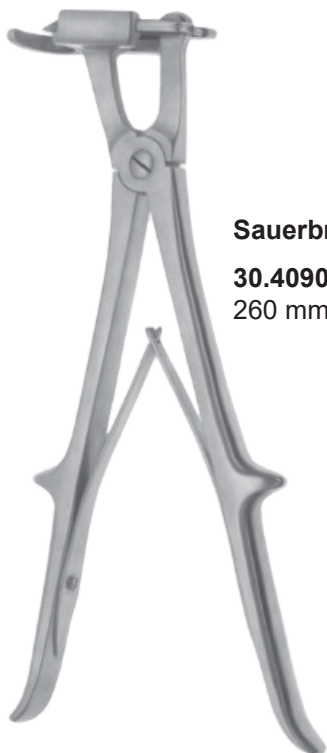

Sauerbruch
30.4090
260 mm



Sauerbruch-Frey
30.4091
360 mm



Finocchietto- Infant

	a	b	c
30.4094	10 mm	15 mm	70 mm



Finocchietto- Baby- Haight

	a	b	c
30.4095	31 mm	31 mm	80 mm

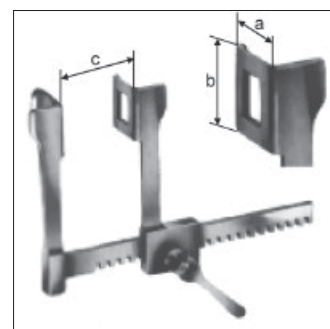

Finocchietto

	a	b	c
30.4096	30 mm	45 mm	140 mm
30.4097	40 mm	62 mm	175 mm
30.4098	64 mm	65 mm	175 mm



Burford

dla dzieci z 2 parami ostrzy
 for children with 2 pairs of blades
 для детей с 2 парами лезвий

	a	b	c
30.4099	41 mm	42 mm	130 mm
	30 mm	42 mm	

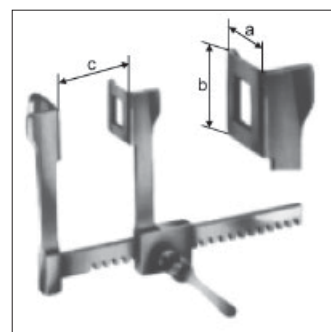

Burford

dla dorosłych z 2 parami ostrzy
for adults with 2 pairs of blades
для взрослых с 2 парами лезвий

	a	b	c
30.4100	65 mm	62 mm	165 mm
	47 mm	62 mm	
30.4101	65 mm	62 mm	250 mm
	47 mm	62 mm	
30.4102	65 mm	62 mm	290 mm
	47 mm	62 mm	



Cooley

dla dzieci
for children
для детей

	a	b	c
30.4104	15 mm	30 mm	100 mm



Cooley

dla noworodków
for newborns
для новорождённых

	a	b	c
30.4103	12 mm	16 mm	70 mm

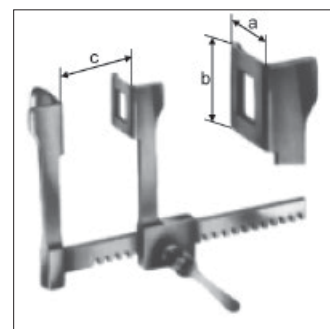

Cooley
 dla dorosłych
 for adults
 для взрослых

	a	b	c
30.4105	21 mm	44 mm	140 mm
30.4106	30 mm	50 mm	165 mm



Castañeda

dla noworodków
 for newborns
 для новорождённых

	a	b	c
30.4107	10,5 mm	32 mm	65 mm

Castañeda

dla dzieci
 for children
 для детей

	a	b	c
30.4108	12 mm	45 mm	70 mm
30.4109	15 mm	60 mm	100 mm

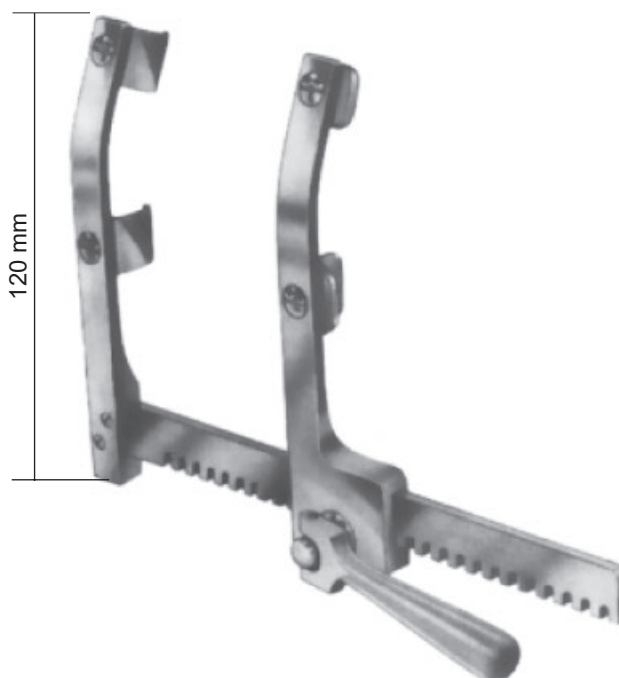

Morse

	a	b	c
30.4110	20 mm	20 mm	165 mm



Finocchetto-Baby

	a	b	c
30.4111	19 mm	20 mm	75 mm

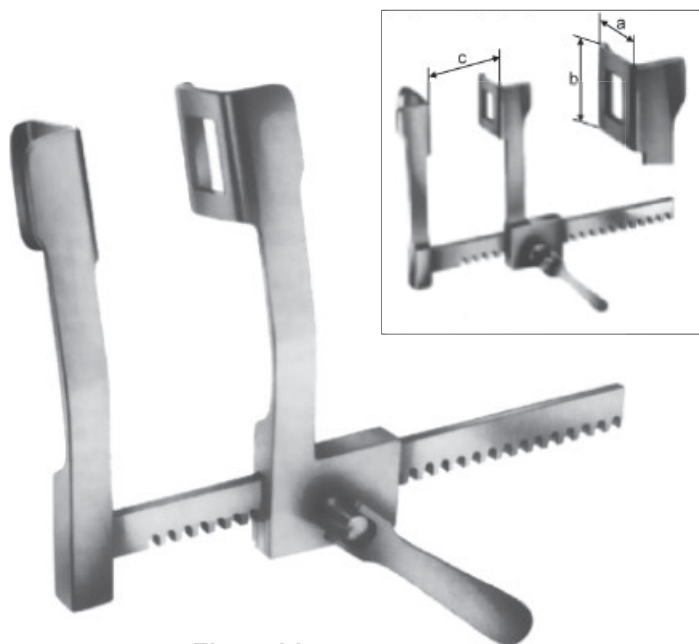

Finocchetto

	a	b	c
30.4112	40 mm	45 mm	165 mm
30.4113	45 mm	65 mm	200 mm
30.4114	65 mm	65 mm	250 mm



Finocchetto-Burford

z 2 parami ostrzy
with 2 pairs of blades
с 2 парами лезвий

	a	b	c
30.4115	80 mm	67 mm	250 mm
	40 mm	67 mm	

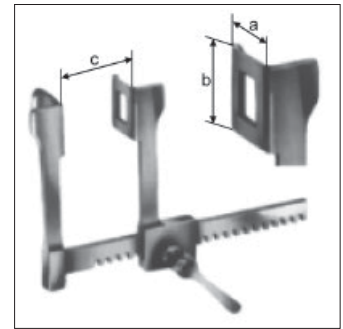

Tuffier

	a	b	c
30.4116	50 mm	45 mm	165 mm



Haight

	a	b	c
30.4117	30 mm	30 mm	90 mm



Cooley

dla dzieci
for children
для детей

	a	b	c
30.4118	21 mm	45 mm	145 mm



Cooley

	a	b	c
30.4119	32 mm	50 mm	190 mm

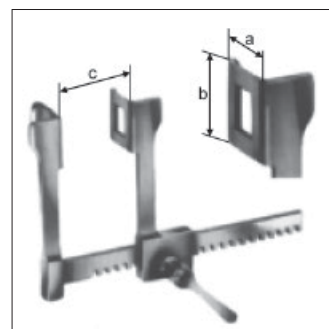

Morse
dla dzieci
for children
для детей

	a	b	c
30.4120	12 mm	20 mm	200 mm

Morse
dla dorosłych
for adults
для взрослых

	a	b	c
30.4121	19 mm	19 mm	200 mm



Morse- Favaloro

	a	b	c
30.4122	38 mm	28 mm	200 mm



Harken

	a	b	c
30.4123	45 mm	65 mm	250 mm

z jedną parą odłączanych ostrzy
with 1 pair of additional detachable blades
с 1 парой добавленных отделенных лезвий

a	b
40 mm	50 mm



Bailey-Gibbon

30.4124

160 mm
dla dorosłych
for adults
для взрослых



Bailey

30.4125

160 mm
dla dzieci
for children
для детей



Bailey-Baby

30.4126

140 mm



Lp. No №	Nazwa wyrobu Product name Наименование изделия	Wymiar (cm) Dimension (cm) Размер (cm)	Nr kat. Cat. No По кат.
1	Opaska zaciskowa niemowlęca Single tourniquet for babies Пневмоманжета неонатальная	30x3	30.0017.000
2	Opaska zaciskowa dziecięca pojedyncza Single tourniquet for children Пневмоманжета детская одинарная	50x6	30.0010.000
3	Opaska zaciskowa na ramię Single arm tourniquet Пневмоманжета на плечо	62x7	30.0016.000
4	Opaska zaciskowa na ramię Single arm tourniquet Пневмоманжета на плечо	64x13	30.0009.000
5	Opaska zaciskowa na ramię - długa Single arm tourniquet long Пневмоманжета на плечо, длинная	82x8	30.0015.000
6	Opaska zaciskowa na udo Single femoral tourniquet Пневмоманжета на бедро	85x14	30.0012.000
7	Opaska zaciskowa na udo stożkowa Conical single femoral tourniquet Пневмоманжета на бедро, конусная	110x11	30.0014.000
8	Opaska zaciskowa na udo Single femoral tourniquet Пневмоманжета на бедро	120x13,5	30.0013.000
9	Opaska zaciskowa na udo Single femoral tourniquet Пневмоманжета на бедро	140x13,5	30.0008.000
1	Opaska zaciskowa dziecięca podwójna Dual tourniquet for children Пневмоманжета детская двойная	50x11	30.0011.000
2	Opaska zaciskowa podwójna Dual tourniquet Пневмоманжета двойная	64x13	30.0019.000
3	Opaska zaciskowa podwójna Dual tourniquet Пневмоманжета двойная	84x16	30.0018.000



30.0077.100
Pompka
Pump
Насос

Opaska uciskowa dł. 5m
Tourniquet length 5m
Пневмоманжета длина 5м

Latex - Free



Szerokość (cm) Width (cm) Ширина (cm)	Nr kat. Cat. No По кат.
6	40.3350.000
8	40.3350.080
10	40.3350.100
15	40.3350.150



30.0020.300

30.0020.300

Pojedynczy zasilacz regulowany opasek zaciskowych

Dane techniczne:

- czynnik roboczy - medyczne sprężone powietrze
- ciśnienie zasilania - 400 kPa
- ciśnienie wyjściowe - 0÷500 mmHg
- pomiar czasu - stoper z dźwiękową sygnalizacją czasu
- wymiary - 20,5 cm x 21 cm x 16 cm
- waga - 2,2 kg
- roczna gwarancja

Single adjustable tourniquet control unit

Technical data:

- working medium - medical compressed air
- supply pressure - 400 kPa
- output pressure - 0÷500 mmHg
- time measurement - electronic countdown timer with alarm
- dimensions - 20.5cm x 21cm x 16cm
- weight - 2.2 kg
- one year warranty

Оди́нарный пневмодозатор для пневмоманжет

Технические параметры:

- рабочий фактор - медицинский сжатый воздух
- давление подачи - 400 kPa
- давление на выходе - 0÷500 mmHg
- измерение времени - секундомер со звуковым сигналом
- размеры - 20,5 см x 21 см x 16 см
- масса - 2,2 кг
- один год гарантии



30.0021.300

30.0021.300

Podwójny zasilacz regulowany opasek zaciskowych

Dane techniczne:

- czynnik roboczy - medyczne sprężone powietrze
- ciśnienie zasilania - 400 kPa
- ciśnienie wyjściowe (2 niezależne wyjścia) - 0÷500 mmHg
- pomiar czasu - stoper z dźwiękową sygnalizacją czasu
- wymiary - 20,5 cm x 21 cm x 16 cm
- waga - 3,2 kg
- roczna gwarancja

Dual adjustable tourniquet control unit

Technical data:

- working medium - medical compressed air
- supply pressure - 400 kPa
- output pressure (2 autonomous exits) - 0÷500 mmHg
- time measurement - electronic countdown timer with alarm
- dimensions - 20.5 cm x 21 cm x 16 cm
- weight - 3.2 kg
- one year warranty

Двои́ной пневмодозатор для пневмоманжет

Технические параметры:

- рабочий фактор - медицинский сжатый воздух
- давление подачи - 400 kPa
- давление на выходе (2 независимые выходы) - 0÷500 mmHg
- измерение времени - секундомер со звуковым сигналом
- размеры - 20,5 см x 21 см x 16 см
- масса - 3,2 кг
- один год гарантии



30.0025.000

Właściwości i wyposażenie:

- dodatkowe zasilanie bateryjne (awaryjne)
- wyświetlacz LCD
- zintegrowany kompresor
- wygodne szybkozłącze do podłączenia opaski zaciskowej
- menu w 3 językach: polskim, angielskim, rosyjskim
- automatyczny timer z możliwością naliczania i odliczania czasu pracy (ucisku)
- panel sterowania wyposażony w „miękkie” przyciski oraz wygodne pokrętko zmiany ustawień
- test szczelności układu zasilacz – opaska zaciskowa
- system monitorujący pracę zasilacza wyposażony w alarmy informujące o problemach

Properties and equipment:

- additional battery power supply (in case of emergency)
- LCD display
- integrated compressor
- convenient connective port for a quick connection between the unit and the tourniquet
- menu available in 3 languages: Polish, English, Russian
- automatic timer allowing for counting up and down the operating time (time of compression)
- control panel equipped with “soft” buttons and a convenient knob allowing for selection of settings
- tightness test of an electronic system – tourniquet
- system controlling the functioning of the EZO-01 device, equipped with alarms notifying about existing problems

Особенности и оснащение:

- дополнительное аккумуляторное питание (аварийное)
- дисплей LCD
- интегрированный компрессор
- выгодный быстросоединитель для соединения с манжетой
- меню на 3 языках: польском, английском, русском
- автоматический таймер с возможностью насчитывания и высчитывания времени работы (сжатия)
- панель управления оборудована в „мягкие” кнопки и удобную ручку изменения настроек
- тест герметичности системы пневмодозатора- манжета
- система мониторинга работы пневмодозатора оборудована в сигнализации, которые информируют о проблемах

Dane techniczne / Технические параметры / Technical parameters	
Zasilanie sieciowe	100÷240 V, 50/60 Hz
Power supply	100÷240 V, 50/60 Hz
Питание	100÷240 В, 50/60 Гц
Pobór mocy	<65 W
Power consumption	<65 W
Потребление мощности	<65 Вт
Akumulator	Li-Ion 14,8V
Battery Type	Li-Ion 14,8V
Аккумулятор	Li-Ion 14,8V
Ciśnienie wyjściowe (na opasce zaciskowej)	100÷550 mmHg (przyrost co 5 mmHg)
Output pressure (in tourniquet)	100÷550 mmHg (with 5 mmHg increments)
Давление на выходе (в манжете)	100÷550 мм рт.ст. каждые 5 мм рт.ст.
Czynnik roboczy	sprężone powietrze (sprężane poprzez zintegrowany kompresor)
Work factor	compressed air (compressed by an integrated compressor)
Рабочее вещество	сжатый воздух (который производит подключённый компрессор)
Minutnik	1÷99 min. (przyrost co 1 min.)
Alarm time setting range	1÷99 min. (with 1 min. increments.)
Диапазон настройки времени	1÷99 мин. (каждую 1 мин.)
Wymiary (W/S/G)	21 cm x 21 cm x 21,5 cm
Dimensions (H/W/D)	21 cm x 21 cm x 21,5 cm
Размеры (H/W/D)	21 см x 21 см x 21,5 см
Ciężar/ Weight/ Вес	4 kg/ 4 kg/ 4 кг
Typ zabezpieczenia przed porażeniem prądem elektrycznym	Klasa I lub wyrób z wewnętrznym źródłem zasilania (Kiedy zasilacz pracuje na zasilaniu wewnętrznym akumulatorowym, typ zabezpieczenia przed porażeniem prądem elektrycznym zmienia się na wyrób z wewnętrznym źródłem zasilania)
Type of protection against electric shock	Class I or Internally Powered Equipment (When the unit is operating on backup battery, the type of protection against electric shock changes to internally powered equipment)
Тип защиты от поражения электрическим током	Класс I либо изделие с внутренним источником питания (когда пневмодозатор работает от внутреннего аккумуляторного питания, тип защиты от поражения электрическим током меняется на изделие с внутренним источником питания)
EMC	EN 60601-1-2
Zgodność z normami	EN 60601-1
Applicable standards	EN 60601-1
Соответствие с нормами	EN 60601-1
Głośność sygnałów dźwiękowych	45-85 dB
Volume of sound signals	45-85 dB
Громкость звуковых сигналов	45-85 dB



30.0026.000

Właściwości i wyposażenie:

- dwa kanały zasilania opasek zaciskowych sprężonym powietrzem z niezależną regulacją ciśnienia i czasu ucisku
- prosta i intuicyjna obsługa
- nieduża, kompaktowa obudowa
- automatyczny minutnik (uruchamiany w momencie napełnienia opaski, zatrzymywany w momencie jej opróżnienia)
- pneumatyczne złącza firmy CPC
- menu w 5 językach: polski, angielski, rosyjski, niemiecki, hiszpański
- dodatkowe zasilanie akumulatorowe
- zintegrowany kompresor
- 6" kolorowy wyświetlacz LCD
- system monitorujący pracę zasilacza
- system monitorujący szczelność układu opaska zaciskowa – zasilacz

Properties and equipment:

- two channels for supplying tourniquets with compressed air with independent regulation pressure and time of pressure
- simple and intuitive usage
- a small, compact casing
- automatic timer (activated during inflating the tourniquet, deactivated during deflating the tourniquet)
- CPC pneumatic connectors
- menu available in 5 languages: Polish, English, Russian, German, Spanish
- additional battery power supply
- integrated compressor
- 6 "color LCD display
- system controlling the functioning of the EZO-02 device
- system controlling the tightness of the tourniquet - electronic system

Особенности и оснащение:

- два канала питания манжет сжатым воздухом с независимой регуляцией давления и времени сжатия
- простое и интуитивное обслуживание
- небольшой, компактный корпус
- автоматический таймер (активируется в моменте наполнения манжеты, останавливается, в моменте её опустошения)
- пневматические соединители фирмы CPC
- меню на 5 языках: польский, английский, русский, немецкий, испанский
- дополнительное аккумуляторное питание
- интегрированный компрессор
- 6" цветной дисплей LCD
- система мониторинга работы пневмодозатора
- система мониторинга герметичности системы манжета – пневмодозатор

Dane techniczne / Технические параметры / Technical parameters	
Zasilanie sieciowe	100÷240 V, 50/60 Hz
Power supply	100÷240 V, 50/60 Hz
Питание	100÷240 В, 50/60 Гц
Robót mocy	<65 W
Power consumption	<65 W
Потребление мощности	<65 Вт
Akumulator	Li-Ion 14,8V
Battery type	Li-Ion 14,8V
Аккумулятор	Li-Ion 14,8V
Ciśnienie wyjściowe (na opasce zaciskowej)	100÷600 mmHg (przyrost co 5 mmHg)
Output pressure (in tourniquet)	100÷600 mmHg (with 5 mmHg increments)
Давление на выходе (в манжете)	100÷600 мм рт.ст. каждые 5 мм рт.ст.
Czynnik roboczy	sprężone powietrze (sprężane poprzez zintegrowany kompresor)
Work factor	compressed air (compressed by an integrated compressor)
Рабочее вещество	сжатый воздух (который производит подключённый компрессор)
Minutnik	1÷120 min. (przyrost co 1 min.)
Alarm time setting range	1÷120 min. (with 1 min. increments.)
Диапазон настройки времени	1÷120 мин. (каждую 1 мин.)
Wymiary (W/S/G)	21 cm x 21 cm x 21,5 cm
Dimensions (H/W/D)	21 cm x 21 cm x 21,5 cm
Размеры (H/W/D)	21 см x 21 см x 21,5 см
Ciężar/Weight/Bec	4,1 kg/ 4.1 kg/ 4,1 кг
Typ zabezpieczenia przed porażeniem prądem elektrycznym	Klasa I lub wyrób z wewnętrznym źródłem zasilania (Kiedy zasilacz pracuje na zasilaniu wewnętrznym akumulatorowym, typ zabezpieczenia przed porażeniem prądem elektrycznym zmienia się na wyrób z wewnętrznym źródłem zasilania)
Type of protection against electric shock	Class I or Internally Powered Equipment (When the unit is operating on backup battery, the type of protection against electric shock changes to internally powered equipment)
Тип защиты от поражения электрическим током	Класс I либо изделие с внутренним источником питания (когда пневмодозатор работает от внутреннего аккумуляторного питания, тип защиты от поражения электрическим током меняется на изделие с внутренним источником питания)
EMC	EN 60601-1-2
Zgodność z normami	EN 60601-1
Applicable standards	EN 60601-1
Соответствие с нормами	EN 60601-1
Głośność sygnałów dźwiękowych	45-85 dB
Volume of sound signals	45-85 dB
Громкость звуковых сигналов	45-85 dB

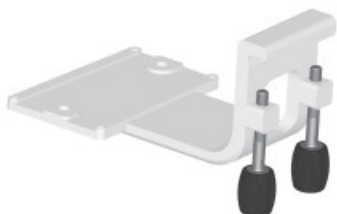

30.4351.000

Uchwyt zasilacza

Tourniquet control unit holder
Держатель пневмодозатора

Uchwyt służy do montażu zasilaczy opasek zaciskowych firmy ChM na systemach szynowy służących do podtrzymywania wyposażenia medycznego zgodnych z normą PN-EN ISO19054:2006.

Mounting clamp is used to mount ChM tourniquet control units on rail systems meant to support medical equipment in accordance with the PN-EN ISO19054:2006 standard.

Держатель используется для установки пневмодозаторов для пневмоманжет ChM на шинных системах для поддержки медицинского оборудования соответствующих стандарту PN-EN ISO19054:2006.



30.0040.000

Statyw przewoźny do zasilaczy

Mobile stand for tourniquet control units
Подставка для пневмодозаторов

Przystosowany do zamontowania każdego zasilacza produkcji ChM

Łatwość przemieszczania na sali operacyjnej

Wyposażenie:

- zestaw kołowy na stabilnej pięcioramiennej podstawie
- dwa blokowane zestawy kół
- kosz na akcesoria
- podwójny hak do podwieszania przewodów
- wysokość kolumny 75 cm
- uchwyt mocujący do zasilaczy

Suited to each tourniquet produced by ChM

Easy moving within the operating room

Consists of:

- 5-star base with castor set
- 2 lockable castors
- basket for accessories
- dual cable hook
- column height 75 cm
- adapter plate for tourniquets

Приспособлен к установке каждого пневмодозатора производства ChM

Лёгкость передвижения по операционной

Комплекующие элементы:

- колесный набор на устойчивой пятиконечной основе
- два комплекта колёс с блокировкой
- корзина для аксессуаров
- двойной крючок для подвески кабелей
- высота стойки 75 см
- фиксирующий держатель для пневмодозатора



40.7243.100 100 mm
40.7243.150 150 mm
40.7243.200 200 mm
40.7243.300 300 mm
40.7243.500 500 mm



40.7244.500
X-Ray
 500 mm



40.7245.150
 z otworami
 with holes
 с отверстиями
 150 mm

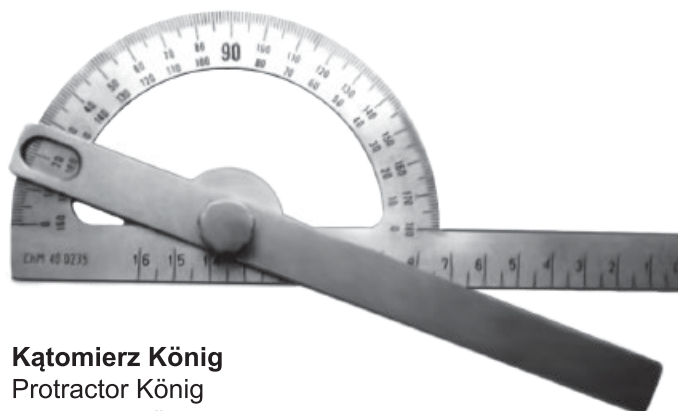

Kątomierz König
 Protractor König
 Угломерт König
40.0235
 200 mm

Nr katalogowy,
Catalogue no.,
Каталожный Но.

Strona
Page
Страна

Nr katalogowy,
Catalogue no.,
Каталожный Но.

Strona
Page
Страна

Nr katalogowy,
Catalogue no.,
Каталожный Но.

Strona
Page
Страна

Nr katalogowy,
Catalogue no.,
Каталожный Но.

Strona
Page
Страна

Indeks

Symbole

22.0009	19	30.0749.001	75	30.4029	16	30.4101	93
22.0010	19	30.0749.002	75	30.4030	16	30.4102	93
22.0011	19	30.0749.003	75	30.4031	16	30.4103	93
22.0012	19	30.0749.004	75	30.4032	16	30.4104	93
22.0013	19	30.0750.001	75	30.4033	16	30.4105	94
22.0015	19	30.0750.002	75	30.4034	16	30.4106	94
22.0016	19	30.0750.003	75	30.4035	16	30.4107	94
22.0017	19	30.0751.000	75	30.4036	16	30.4108	94
22.0018	19	30.0752.000	75	30.4037	16	30.4109	94
22.0020	19	30.1460	79	30.4038	16	30.4110	94
22.0021	19	30.1462	79	30.4039	16	30.4111	95
22.0022	19	30.1464	79	30.4040	16	30.4112	95
22.0025	19	30.1466	79	30.4041	16	30.4113	95
22.0026	19	30.1467	79	30.4042	16	30.4114	95
22.0027	19	30.1471	79	30.4043	17	30.4115	95
22.0029	19	30.1472	79	30.4044	17	30.4116	96
22.0030	19	30.1473	79	30.4045	17	30.4117	96
30.0008	100	30.1474	79	30.4046	17	30.4118	96
30.0009	100	30.1475	79	30.4047	17	30.4119	96
30.0010	100	30.1476	79	30.4048	17	30.4120	97
30.0011	100	30.1477	79	30.4049	17	30.4121	97
30.0012	100	30.1478	79	30.4050	17	30.4122	97
30.0013	100	30.1482.000	79	30.4051	17	30.4123	98
30.0014	100	30.1482.100	79	30.4052	17	30.4124	99
30.0015	100	30.1484	80	30.4053	53	30.4125	99
30.0016	100	30.1485	80	30.4054	53	30.4126	99
30.0017	100	30.1486	80	30.4055	25	30.4130	60
30.0018	100	30.2505.000	56	30.4056	25	30.4169	66
30.0019	100	30.2505.140	56	30.4057	25	30.4171	66
30.0020.300	101	30.2505.200	56	30.4058	25	30.4172	66
30.0021.300	101	30.2940	9	30.4059	25	30.4173	66
30.0025.000	102	30.2944	9	30.4060	26	30.4174	66
30.0026.000	103	30.2945	9	30.4061	26	30.4175	67
30.0028	9	30.2946	9	30.4063	26	30.4176	67
30.0029	9	30.2947	9	30.4064	25	30.4177	67
30.0030	9	30.2949	9	30.4065	25	30.4178	67
30.0031	9	30.3513.000	8	30.4066	24	30.4179	67
30.0032	9	30.3513.100	8	30.4067	24	30.4180	67
30.0033	9	30.3513.200	8	30.4068	24	30.4181	67
30.0034	9	30.4000	17	30.4069	24	30.4182	67
30.0040	104	30.4001	17	30.4070	26	30.4183	67
30.0077.100	100	30.4002	17	30.4071	26	30.4183.100	67
30.0740.001	74	30.4003	17	30.4072	33	30.4200	26
30.0740.002	74	30.4004	17	30.4073	33	30.4201	26
30.0741.000	74	30.4005	17	30.4074	33	30.4202	26
30.0742.001	74	30.4006	17	30.4075	26	30.4203	27
30.0742.002	74	30.4007	17	30.4076	26	30.4204	27
30.0743.001	74	30.4008	17	30.4080	33	30.4205	27
30.0743.002	74	30.4009	17	30.4081	33	30.4206	27
30.0743.003	74	30.4010	17	30.4082	90	30.4207	27
30.0744.001	74	30.4011	17	30.4083	90	30.4208	27
30.0744.002	74	30.4012	17	30.4084	90	30.4209	27
30.0744.003	74	30.4013	17	30.4085	90	30.4210	27
30.0745.001	75	30.4014	17	30.4086	90	30.4211	27
30.0745.002	75	30.4015	17	30.4087	90	30.4212	27
30.0745.003	75	30.4016	17	30.4088	90	30.4213	27
30.0746.001	75	30.4017	17	30.4089	90	30.4214	27
30.0746.002	75	30.4018	17	30.4090	91	30.4220	62
30.0746.003	75	30.4019	17	30.4091	91	30.4220.100	62
30.0747.000	75	30.4020	17	30.4092	91	30.4221	62
30.0748.000	75	30.4021	17	30.4093	91	30.4221.100	62
		30.4022	17	30.4094	92	30.4222	62
		30.4023	17	30.4095	92	30.4222.100	62
		30.4024	17	30.4096	92	30.4223	62
		30.4025	17	30.4097	92	30.4225	64
		30.4026	17	30.4098	92	30.4351	104
		30.4027	17	30.4099	92	40.0010	16
		30.4028	16	30.4100	93	40.0011	16

Nr katalogowy, Catalogue no., Каталожный Но.	Strona Page Страна	Nr katalogowy, Catalogue no., Каталожный Но.	Strona Page Страна	Nr katalogowy, Catalogue no., Каталожный Но.	Strona Page Страна	Nr katalogowy, Catalogue no., Каталожный Но.	Strona Page Страна
40.0012	16	40.0121	9	40.0236	18	40.0428	24
40.0013	16	40.0122	9	40.0237	18	40.0429	24
40.0014	16	40.0123	18	40.0238	18	40.0430	24
40.0015	23	40.0124	18	40.0239	18	40.0431	24
40.0016	23	40.0125	13	40.0245	16	40.0432	8
40.0017	16	40.0126	13	40.0246	16	40.0433	60
40.0020	12	40.0127	13	40.0247	16	40.0434	60
40.0022	16	40.0128	13	40.0248	16	40.0485	14
40.0023	16	40.0129	13	40.0249	16	40.0486	14
40.0029	12	40.0134	18	40.0251	36	40.0487	14
40.0034	16	40.0139	18	40.0252	34	40.0488	14
40.0039	12	40.0145	18	40.0255	34	40.0489	14
40.0040	16	40.0146	18	40.0256	23	40.0490	14
40.0041	16	40.0147	18	40.0257	23	40.0491	14
40.0042	16	40.0148	18	40.0258	23	40.0492	14
40.0043	16	40.0149	18	40.0259	23	40.0493	11
40.0044	16	40.0155	16	40.0260	34	40.0494	11
40.0046	12	40.0156	16	40.0261	34	40.0495	11
40.0047	12	40.0157	16	40.0262	12	40.0496	23
40.0048	12	40.0158	16	40.0263	12	40.0500	23
40.0049	12	40.0159	16	40.0264	12	40.0510	16
40.0050	15	40.0162	13	40.0266	13	40.0511	16
40.0051	15	40.0163	13	40.0267	13	40.0512	16
40.0052	15	40.0164	13	40.0268	13	40.0513	16
40.0053	15	40.0165	13	40.0269	13	40.0514	16
40.0054	15	40.0166	13	40.0270	13	40.0538	24
40.0055	15	40.0167	13	40.0271	13	40.0539	24
40.0056	12	40.0168	13	40.0272	13	40.0544	59
40.0057	12	40.0174	18	40.0273	13	40.0545	44
40.0058	12	40.0175	18	40.0274	13	40.0546	59
40.0059	12	40.0176	18	40.0275	64	40.0547	59
40.0060	15	40.0177	18	40.0276	13	40.0582	52
40.0061	15	40.0178	18	40.0277	13	40.0583	52
40.0062	15	40.0179	18	40.0278	13	40.0584	52
40.0063	15	40.0194	13	40.0279	23	40.0585	51
40.0064	15	40.0195	13	40.0280	54	40.0586	49
40.0065	15	40.0196	13	40.0281	54	40.0587	49
40.0066	15	40.0197	13	40.0282	23	40.0603	51
40.0067	15	40.0198	13	40.0283	23	40.0604	51
40.0068	15	40.0199	13	40.0284	23	40.0605	51
40.0069	15	40.0201	18	40.0286	23	40.0610	50
40.0070	15	40.0202	18	40.0287	23	40.0614	68
40.0071	15	40.0203	18	40.0288	54	40.0615	68
40.0072	12	40.0204	18	40.0289	54	40.0619	49, 50
40.0073	23	40.0209	18	40.0290	9	40.0621	49, 50
40.0074	23	40.0210	12	40.0291	13	40.0835	50
40.0075	23	40.0211	12	40.0292	13	40.0836	50
40.0076	23	40.0212	12	40.0296	13	40.0837	50
40.0077	23	40.0213	12	40.0297	13	40.0839	50
40.0078	23	40.0214	12	40.0301	15	40.0987.200	69
40.0080	15	40.0215	12	40.0302	15	40.1001.000	76
40.0081	15	40.0216	12	40.0303	15	40.1002.001	76
40.0082	15	40.0217	12	40.0304	15	40.1002.002	76
40.0083	15	40.0218	12	40.0305	15	40.1002.003	76
40.0084	15	40.0219	12	40.0306	15	40.1003.000	76
40.0085	15	40.0220	12	40.0307	15	40.1004.001	76
40.0086	15	40.0221	12	40.0308	15	40.1004.002	76
40.0087	15	40.0222	12	40.0413	7	40.1005.000	76
40.0088	15	40.0223	12	40.0415	47	40.1006.000	76
40.0089	15	40.0224	12	40.0416	47	40.1007.001	77
40.0100	47	40.0226	12	40.0417	47	40.1007.002	77
40.0101	47	40.0227	12	40.0418	47	40.1007.003	77
40.0102	47	40.0228	12	40.0420	47	40.1008.001	77
40.0103	47	40.0229	18	40.0421	47	40.1008.002	77
40.0108	17	40.0231	7	40.0422	47	40.1009.000	77
40.0109	17	40.0232	18	40.0423	47	40.1010.000	77
40.0118	17	40.0233	18	40.0425	24	40.1011.000	77
40.0119	17	40.0234	18	40.0426	24	40.1012.004	78
40.0120	59	40.0235	105	40.0427	24	40.1012.006	78

Nr katalogowy, Catalogue no., Каталожный Но.	Strona Page Страна	Nr katalogowy, Catalogue no., Каталожный Но.	Strona Page Страна	Nr katalogowy, Catalogue no., Каталожный Но.	Strona Page Страна	Nr katalogowy, Catalogue no., Каталожный Но.	Strona Page Страна
40.1012.008	78	40.2059	68	40.3077.100	33	40.3338.004	35
40.1012.010	78	40.2060	68	40.3078	33	40.3338.005	35
40.1012.012	78	40.2061	68	40.3168	60	40.3338.006	35
40.1013.000	78	40.2062	68	40.3169	60	40.3339	37
40.1014.004	78	40.2063	68	40.3170	60	40.3350.000	100
40.1014.005	78	40.2064	68	40.3171	60	40.3350.080	100
40.1014.006	78	40.2065	68	40.3172	60	40.3350.100	100
40.1014.007	78	40.2066	68	40.3175	65	40.3350.150	100
40.1014.009	78	40.2068	68	40.3176	64	40.3352	7
40.1014.012	78	40.2069	68	40.3176.160	64	40.3353	7
40.1015.008	78	40.2135	68	40.3177	65	40.3354	7
40.1015.016	78	40.2136	68	40.3180	64	40.3355	7
40.1100	48	40.2137	68	40.3185	62	40.3356	8
40.1101	48	40.2138	68	40.3186	62	40.3356.005	8
40.1102	48	40.2178	31	40.3190	8	40.3357	8
40.1103	48	40.2179	31	40.3191	8	40.3357.005	8
40.1104	48	40.2180	31	40.3192	8	40.3358	8
40.1105	48	40.2181	31	40.3193	8	40.3358.005	8
40.1207	28	40.2182	31	40.3194	61	40.3359	8
40.1208	28	40.2183	31	40.3195	61	40.3359.005	8
40.1209	28	40.2184	31	40.3196.180	61	40.3563	23
40.1210	28	40.2185	29	40.3196.200	61	40.3564	23
40.1211	28	40.2186	29	40.3196.240	61	40.3566	41
40.1212	28	40.2187	29	40.3197.220	61	40.3567	41
40.1213	28	40.2188	29	40.3197.250	61	40.3570	73
40.1214	28	40.2189	29	40.3197.300	61	40.3599	69
40.1215	28	40.2190	29	40.3198	61	40.3674	68
40.1216	28	40.2191	29	40.3232	72	40.3694	73
40.1217	28	40.2192	29	40.3264	56	40.3695	73
40.1218	28	40.2193	29	40.3264.200	57	40.3800	35
40.1350.000	72	40.2194	29	40.3265	56	40.3801	35
40.1363	68	40.2195	30	40.3266	57	40.3802	35
40.1364	68	40.2196	30	40.3267	57	40.3803	35
40.1365	68	40.2197	30	40.3268	56	40.3804	35
40.1386	68	40.2198	30	40.3269	56	40.3805	35
40.1387	68	40.2199	30	40.3275	34	40.3806	35
40.1388	68	40.2200	30	40.3276	34	40.3807	35
40.1390	89	40.2201	30	40.3278	58	40.3808	35
40.1391	89	40.2203	30	40.3279	58	40.3809	35
40.1392	89	40.2204	30	40.3282	58	40.3809.100	35
40.1393.008	89	40.2205.032	33	40.3283	58	40.3811	36
40.1393.012	89	40.2205.038	33	40.3284	58	40.3812	36
40.1394	89	40.2290	83	40.3285	58	40.3813	36
40.1395	89	40.2291	83	40.3286	58	40.3814	36
40.1898	68	40.2292	83	40.3287	58	40.3815	36
40.1899	68	40.2293	83	40.3290	59	40.3816	36
40.2036.150	68	40.2295	83	40.3291	59	40.3817	36
40.2037.150	68	40.2296	83	40.3292	59	40.3818	36
40.2038.150	68	40.2297	83	40.3293	59	40.3819	36
40.2040.150	68	40.2298	83	40.3302	36	40.3820	38
40.2040.200	68	40.2305	83	40.3303	36	40.3821	38
40.2041	68	40.2306	83	40.3304	36	40.3822	38
40.2042	68	40.2307	83	40.3306	36	40.3823	38
40.2043	68	40.2308	83	40.3307	36	40.3824	38
40.2044	68	40.2310	83	40.3308	36	40.3825	38
40.2045	68	40.2311	83	40.3309	34	40.3827	38
40.2046	68	40.2312	83	40.3309.100	34	40.3828	38
40.2047	68	40.2313	83	40.3310	34	40.3829	38
40.2048	68	40.2545	69	40.3311	34	40.3830	38
40.2049	68	40.2546	69	40.3312	34	40.3831	39
40.2050	68	40.2547	69	40.3313	35	40.3832	39
40.2051	68	40.2548	69	40.3314	35	40.3833	39
40.2052	68	40.2550	69	40.3315	35	40.3834	39
40.2053	68	40.2552	69	40.3316	35	40.3835	39
40.2054	68	40.2553	69	40.3317	35	40.3837	39
40.2055	68	40.2554	69	40.3318	35	40.3838	39
40.2056	68	40.3075	33	40.3337.004	35	40.3839	39
40.2057	68	40.3076	33	40.3337.005	35	40.3840	39
40.2058	68	40.3077	33	40.3337.006	35	40.3841	39

Nr katalogowy, Catalogue no., Каталожный Но.	Strona Page Страна	Nr katalogowy, Catalogue no., Каталожный Но.	Strona Page Страна	Nr katalogowy, Catalogue no., Каталожный Но.	Strona Page Страна	Nr katalogowy, Catalogue no., Каталожный Но.	Strona Page Страна
40.3843	40	40.4006	20	40.4074	22	40.4213	46
40.3844	40	40.4007	20	40.4075	22	40.4214	46
40.3845	40	40.4008	20	40.4076	22	40.4215	46
40.3846	40	40.4009	20	40.4077	22	40.4216	46
40.3847	40	40.4010	20	40.4078	22	40.4217	46
40.3849	40	40.4011	20	40.4079	22	40.4218	46
40.3895	41	40.4012	20	40.4080	22	40.4219	46
40.3896	41	40.4013	20	40.4081	22	40.4220	46
40.3897	41	40.4014	20	40.4082	22	40.4221	46
40.3898	41	40.4015	20	40.4083	22	40.4222	46
40.3899	41	40.4016	20	40.4084	22	40.4223	46
40.3900	41	40.4017	20	40.4085	22	40.4224	46
40.3901	41	40.4018	20	40.4086	22	40.4225	47
40.3902	41	40.4019	20	40.4087	22	40.4226	47
40.3903	41	40.4020	20	40.4088	22	40.4227	47
40.3904	41	40.4021	21	40.4089	22	40.4228	47
40.3905	42	40.4022	21	40.4090	22	40.4228.100	47
40.3906	42	40.4023	21	40.4091	22	40.4229	46
40.3907	42	40.4024	21	40.4092	22	40.4230	46
40.3908	42	40.4025	21	40.4093	22	40.4231	46
40.3909	42	40.4026	21	40.4139	55	40.4232	46
40.3910	42	40.4027	21	40.4139.001	55	40.4233	46
40.3911	42	40.4028	21	40.4139.100	55	40.4234	48
40.3912	42	40.4029	21	40.4139.101	55	40.4235	48
40.3913	42	40.4030	21	40.4140	55	40.4236	48
40.3914	42	40.4031	21	40.4140.001	55	40.4240	48
40.3915	42	40.4032	21	40.4140.100	55	40.4241	48
40.3916	42	40.4033	21	40.4140.101	55	40.4242	48
40.3917	42	40.4034	21	40.4141	56	40.4243	48
40.3921	42	40.4035	21	40.4142	56	40.4245	73
40.3922	42	40.4036	21	40.4143	56	40.4246	73
40.3925.000	72	40.4037	21	40.4143.200	57	40.4248	73
40.3926.000	72	40.4038	21	40.4144	56	40.4249	73
40.3927.000	72	40.4039	21	40.4144.001	56	40.4250	73
40.3928.000	72	40.4040	21	40.4144.200	57	40.4251	73
40.3929.000	72	40.4041	21	40.4145	56	40.4265	83
40.3929.001	72	40.4042	21	40.4145.001	56	40.4266	83
40.3930.000	72	40.4043	21	40.4145.200	57	40.4267	83
40.3976	20	40.4044	21	40.4145.201	57	40.4268	83
40.3977	20	40.4045	21	40.4147	43	40.4269	83
40.3978	20	40.4046	21	40.4148	43	40.4270	83
40.3979	20	40.4047	21	40.4149	43	40.4271	83
40.3980	20	40.4048	21	40.4150	43	40.4272	83
40.3981	20	40.4049	21	40.4151	43	40.4273	83
40.3982	20	40.4050	21	40.4152	43	40.4274	83
40.3983	20	40.4051	21	40.4153	43	40.4275	83
40.3984	20	40.4052	21	40.4154	43	40.4276	83
40.3985	20	40.4053	21	40.4155	44	40.4277	83
40.3986	20	40.4054	21	40.4156	44	40.4278	83
40.3987	20	40.4055	21	40.4156.100	44	40.4279	83
40.3988	20	40.4056	21	40.4157	44	40.4280	83
40.3989	20	40.4057	21	40.4158	44	40.4281	83
40.3990	20	40.4058	21	40.4159	44	40.4282	83
40.3991	20	40.4059	21	40.4160	44	40.4283	83
40.3992	20	40.4060	21	40.4161.200	44	40.4284	83
40.3993	20	40.4061	21	40.4200	44	40.4285	83
40.3994	20	40.4062	21	40.4201	44	40.4286	83
40.3995	20	40.4063	21	40.4202	45	40.4287	83
40.3996	20	40.4064	21	40.4203	45	40.4288	83
40.3997	20	40.4065	21	40.4204	45	40.4289	83
40.3998	20	40.4066	21	40.4205	45	40.4290	83
40.3999	20	40.4067	21	40.4206	45	40.4291	83
40.4000	20	40.4068	21	40.4207	45	40.4292	83
40.4001	20	40.4069	22	40.4208	45	40.4293	83
40.4002	20	40.4070	22	40.4209	45	40.4294	83
40.4003	20	40.4071	22	40.4210	45	40.4295	83
40.4004	20	40.4072	22	40.4211	45	40.4296	83
40.4005	20	40.4073	22	40.4212	46	40.4297	83

Nr katalogowy, Catalogue no., Каталожный Но.	Strona Page Страна	Nr katalogowy, Catalogue no., Каталожный Но.	Strona Page Страна	Nr katalogowy, Catalogue no., Каталожный Но.	Strona Page Страна	Nr katalogowy, Catalogue no., Каталожный Но.	Strona Page Страна
40.4298	83	40.4396.000	86	40.4546	70, 71	40.5108.400	70
40.4299	83	40.4397.000	86	40.4546.000	70	40.5108.500	70
40.4300	83	40.4398	86	40.4546.100	70	40.5109	70, 71
40.4301	83	40.4398.025	86	40.4546.200	70	40.5109.000	70
40.4302	83	40.4399	87	40.4546.300	70	40.5109.100	70
40.4303	83	40.4400	87	40.4546.400	70	40.5109.200	70
40.4304	83	40.4401	87	40.4546.500	70	40.5109.300	70
40.4305	83	40.4402	87	40.4547	70, 71	40.5109.400	70
40.4306	83	40.4403	87	40.4547.000	70	40.5109.500	70
40.4307	83	40.4407	88	40.4547.100	70	40.5110	70, 71
40.4308	83	40.4408	88	40.4547.200	70	40.5110.000	70
40.4334	84	40.4409	88	40.4547.300	70	40.5110.100	70
40.4335	84	40.4410	88	40.4547.400	70	40.5110.200	70
40.4336	84	40.4411	88	40.4547.500	70	40.5110.300	70
40.4337	84	40.4412	88	40.4548	70, 71	40.5110.400	70
40.4338	84	40.4413	88	40.4548.000	70	40.5110.500	70
40.4339	84	40.4414	88	40.4548.100	70	40.5111	70, 71
40.4340	84	40.4415	88	40.4548.200	70	40.5111.000	70
40.4341	84	40.4416	88	40.4548.300	70	40.5111.100	70
40.4342	84	40.4417	88	40.4548.400	70	40.5111.200	70
40.4343	84	40.4418	88	40.4548.500	70	40.5111.300	70
40.4344	84	40.4443	62	40.4575	8	40.5111.400	70
40.4345	84	40.4444	63	40.4576	10	40.5111.500	70
40.4346	84	40.4445	63	40.4584	68	40.5112	70, 71
40.4347	84	40.4530	10	40.4747.500	72	40.5112.000	70
40.4348	84	40.4532	10	40.4749.600	72	40.5112.100	70
40.4349	84	40.4533	10	40.4783	82	40.5112.200	70
40.4350	84	40.4534	10	40.5045.000	54	40.5112.300	70
40.4351	84	40.4535	10	40.5103	70	40.5112.400	70
40.4352	84	40.4536	10	40.5103.000	70	40.5112.500	70
40.4353	84	40.4537	10	40.5103.100	70	40.5113	70, 71
40.4354	84	40.4539	10	40.5103.200	70	40.5113.000	70
40.4355	84	40.4540	10	40.5103.300	70	40.5113.100	70
40.4356	84	40.4541	70	40.5103.400	70	40.5113.200	70
40.4357	84	40.4541.000	70	40.5103.500	70	40.5113.300	70
40.4358	84	40.4541.100	70	40.5104	70	40.5113.400	70
40.4359	84	40.4541.200	70	40.5104.000	70	40.5113.500	70
40.4360	84	40.4541.300	70	40.5104.100	70	40.5114	70, 71
40.4361	84	40.4541.400	70	40.5104.200	70	40.5114.000	70
40.4366	84	40.4541.500	70	40.5104.300	70	40.5114.100	70
40.4367	84	40.4542	70, 71	40.5104.400	70	40.5114.200	70
40.4368	84	40.4542.000	70	40.5104.500	70	40.5114.300	70
40.4369	84	40.4542.100	70	40.5105	70	40.5114.400	70
40.4370	85	40.4542.200	70	40.5105.000	70	40.5114.500	70
40.4371	85	40.4542.300	70	40.5105.100	70	40.5115	70, 71
40.4372	85	40.4542.400	70	40.5105.200	70	40.5115.000	70
40.4373.150	85	40.4542.500	70	40.5105.300	70	40.5115.100	70
40.4374.150	85	40.4543	70, 71	40.5105.400	70	40.5115.200	70
40.4375.150	85	40.4543.000	70	40.5105.500	70	40.5115.300	70
40.4376	85	40.4543.100	70	40.5106	70, 71	40.5115.400	70
40.4380.000	86	40.4543.200	70	40.5106.000	70	40.5115.500	70
40.4381.000	86	40.4543.300	70	40.5106.100	70	40.5116	70, 71
40.4382.000	86	40.4543.400	70	40.5106.200	70	40.5116.000	70
40.4382.005	86	40.4543.500	70	40.5106.300	70	40.5116.100	70
40.4382.006	86	40.4544	70, 71	40.5106.400	70	40.5116.200	70
40.4384.000	86	40.4544.000	70	40.5106.500	70	40.5116.300	70
40.4385.000	86	40.4544.100	70	40.5107	70, 71	40.5116.400	70
40.4385.005	86	40.4544.200	70	40.5107.000	70	40.5116.500	70
40.4387.000	86	40.4544.300	70	40.5107.100	70	40.5117	70, 71
40.4388.000	86	40.4544.400	70	40.5107.200	70	40.5117.000	70
40.4389.000	86	40.4544.500	70	40.5107.300	70	40.5117.100	70
40.4390.000	86	40.4545	70, 71	40.5107.400	70	40.5117.200	70
40.4391.000	86	40.4545.000	70	40.5107.500	70	40.5117.300	70
40.4391.005	86	40.4545.100	70	40.5108	70, 71	40.5117.400	70
40.4391.006	86	40.4545.200	70	40.5108.000	70	40.5117.500	70
40.4393.000	86	40.4545.300	70	40.5108.100	70	40.5118	70, 71
40.4394.000	86	40.4545.400	70	40.5108.200	70	40.5118.000	70
40.4394.005	86	40.4545.500	70	40.5108.300	70	40.5118.100	70

Nr katalogowy, Catalogue no., Каталожный Но.	Strona Page Страна	Nr katalogowy, Catalogue no., Каталожный Но.	Strona Page Страна	Nr katalogowy, Catalogue no., Каталожный Но.	Strona Page Страна	Nr katalogowy, Catalogue no., Каталожный Но.	Strona Page Страна
40.5118.200	70	Aleksander	18	Friedmann	38	Mac Evan - Stille	16
40.5118.300	70			Frykholm	35	Mannerfelt	12, 74, 75, 76, 77
40.5118.400	70	B				Martel	8
40.5118.500	70	Bailey	99	G		Martini	22
40.5119	70, 71	Bailey-Baby	99	Gallaher	10	McDonald	26
40.5119.000	70	Bailey-Gibbon	99	Gerster	48	Mc Indoe	41
40.5119.100	70	Bennet	30	Gester-Lowman	48	Mick	57
40.5119.200	70	Bergman	23	Giertz-Stille	90	Micro-Friedmann	39
40.5119.300	70	Bethune	90	Gigli	8	Milligan	79
40.5119.400	70	Beyer	34	Gluck	90	Mini-Friedmann	38
40.5119.500	70	Bircher-Ganske	44	Gwóźdz Steinmanna	51	Mini-Hohmann	29
40.5762.200	72	Blount	33			Mollison	80
40.5762.300	72	Blumenthal	39	H		Morse	94, 97
40.6016	45	Böhler	35, 41	Haglund-Stille	59	Morse- Favaloro	97
40.6069	51	Brunner	90	Haight	96	N	
40.6375	72	Bruns	20, 21, 58	Hajek	23	Nóż Virchowa	8
40.7208.030	82	Buck-Gramcko	29	Halle	22	O	
40.7210	82	Burford	92, 93	Harken	98	Oldberg	85
40.7211	82			Henning	59	Olivecron	38
40.7212.180	82	C		Hercules	66, 67	Olivecrona	8
40.7212.280	82	Castañeda	94	Hey-Groves	48	Ołowiana ręka	53
40.7214.400	32	Catlin	9	Hibbs	16, 17	P	
40.7215.000	32	Championniere	12	Hohmann	29, 30	Partsch	18
40.7215.130	32	ChM	15	Hohmann - Aldinger	30	Passow	11
40.7216	82	Ciężarki do wyciągu	50	Hopkins	59	Putti	10
40.7217	82	Cinelli	19	Howarth	27	R	
40.7218	82	Cleveland	39, 41			Rączka Steinmanna	69
40.7230.005	13	Cloward	85, 89	I		Reiner	59
40.7230.010	13	Cobb	14	Inge	89	Resano	82
40.7230.015	13	Cone	79	J		Rottgen-Ruskin	35
40.7231.005	13	Cooley	93, 94, 96	Jansen	22, 34	Rubin	40
40.7231.010	13	Cottle	78	Joseph	10, 26	Ruskin	35, 41
40.7231.015	13	Cottle Fishtail	78	K		Ruskin-Liston	41
40.7232.000	32	Cushing	84	Kern	45	S	
40.7234.000	32					Sauerbruch	36, 91
40.7240	88	D		Lambotte	12, 24, 46	Sauerbruch-Frey	91
40.7241	88	Dahmen	14	Lambotte - mini	12	Schede	20
40.7242	88	Daubenspeck	21	Lane	46	Sedillot	26
40.7243.100	105	Demel	60	Lange-Hohmann	29	Selverstone	87
40.7243.150	105	Dingmann	43	Lange-Hohmann modyf.	29	Semb	27, 35, 42, 44
40.7243.200	105	Doyen	27	Langenbeck	9, 24, 44	Seutin	58
40.7243.300	105			Lebsche	91	Silver	19
40.7243.500	105	E		Leksell	36	Simon	21
40.7244.500	105	Echlin	34	Lempert	22, 40	Smith - Petersen	17
40.7245.150	105	Elektryczna piła	54	Lewin	43	Spratt	21
40.7248	63	Engel	59	Lexer	13	Stellbrink	38
40.7249	63	Esmarch	58, 59	Lexer - mini	13	Stille	16, 58
40.7250	63			Lister	56, 57	Stille-Liston	42
40.7251	63	F		Liston	9, 42	Stille-Luer	35
40.7252	63	Farabeuf	24, 45	Liston Key	42	Stille-Luer	34
40.7253	65	Farabeuf-Lambotte	45	Liston mini	41	Stille-Ruskin	34
40.7253.100	65	Ferguson	44	Loute	60	Sypert	37
40.7254	65	Ferris-Smith	88	Lowman	48	T	
40.7261	45	Ferris-Smith-Kerrison	83	Lowman-Baby	48	Taylor	33
40.7262	45	Finocchietto	92, 95	Lowman-Houglund	48	Tuffier	96
40.7262.001	45	Finocchietto-Baby	95	Lucas	17		
40.7262.002	45	Finocchietto-Baby- Haight	92	Luer	38		
40.7263	45	Finocchietto-Burford	95				
40.7271	69	Finocchietto- Infant	92				
40.7272	69	Fomon	19				
40.8395	81	Freer	76, 77				
40.8396	81	Freer - Joseph	76				
40.8709	51	Freer -Yasargil	76				
				M			
A							
Adson	24, 39						
Adson-Baby	80						

Nr katalogowy, Catalogue no., Каталожный Но.	Strona Page Страна	Nr katalogowy, Catalogue no., Каталожный Но.	Strona Page Страна	Nr katalogowy, Catalogue no., Каталожный Но.	Strona Page Страна	Nr katalogowy, Catalogue no., Каталожный Но.	Strona Page Страна
--	--------------------------	--	--------------------------	--	--------------------------	--	--------------------------

U

Uchwyt do ciężarków 50
Ulrich 47

V

Van-Buren 44
Verbrugge 46, 47
Verbrugge-Baby 47
Volkmann 20, 22

W

Wagner 14, 25, 29, 86
Weitlaner-Loktite 79
Weitlaner-Wullstein 79
West 77
Williger 26
Willinger 21, 22
Wolf 59

Y

Yasargil 87

Z

Zaufal Jansen 34
Zielke 18

ChM sp. z o.o.
Lewickie 3b
16-061 Juchnowiec Kościelny
Poland
tel.: +48 85 86 86 100
fax: +48 85 86 86 101
chm@chm.eu
www.chm.eu