

CHM[®]

NARZĘDZIA CHIRURGICZNE
SURGICAL INSTRUMENTS
ХИРУРГИЧЕСКИЕ ИНСТРУМЕНТЫ



NARZĘDZIA CHIRURGICZNE
SURGICAL INSTRUMENTS
ХИРУРГИЧЕСКИЕ ИНСТРУМЕНТЫ

CHIRURGIA OGÓLNA

GENERAL SURGERY

ОБЩАЯ ХИРУРГИЯ5

LARYNGOLOGIA

ENT

ЛАРИНГОЛОГИЯ161

GINEKOLOGIA

GYNECOLOGY

ГИНЕКОЛОГИЯ.....179

INNE

OTHERS

ДРУГИЕ.....215

40 lat

doświadczenia

Historia marki sięga roku 1981, kiedy przez Mikołaja Charkiewicza zostaje powołana do życia firma ChM. W roku 1985 rozpoczęto prace związane z produkcją prostych narzędzi chirurgicznych, a rok później, w 1986 r., powołano biuro projektowe, którego zadaniem było opracowywanie konstrukcji i technologii wytwarzania wyrobów stosowanych w ortopedii i traumatologii. Choć dostępna w tym czasie w Polsce wiedza na temat materiałów, technologii czy funkcjonowania narzędzi medycznych była bardzo ograniczona, już na początku lat 90-tych firma rozpoczęła produkcję pierwszych prostych implantów metalowych. W roku 2004 firma przekształciła się w jednostkę z osobowością prawną pod nazwą ChM spółka z ograniczoną odpowiedzialnością.

Obecny sukces firmy zawdzięczamy początkowym ograniczeniom. To one stały się przyczynkiem do ciągłych poszukiwań, samokształcenia oraz tworzenia własnej bazy badawczej. Dzisiejsza współpraca obejmuje zarówno środowisko medyczne jak i instytucje badawcze w kraju i zagranicą. 40 lat doświadczeń nauczyło nas słuchać i reagować na potrzeby dynamicznie rozwijającej się medycyny. Cały ten okres to rozwój oparty na relacjach wzajemnego zaufania. To właśnie dzięki nim możemy rozbudowywać portfolio naszych produktów.

Oferowane przez nas narzędzia to najwyższej jakości wyroby medyczne, wytwarzane zgodnie z obowiązującą wersją norm EN ISO 9001:2015 oraz EN ISO 13485:2016 i zgodne z Dyrektywą 93/42/EEC dotyczącą produktów medycznych.

Narzędzia są w specjalny sposób oznakowane kodem DATAMATRIX. Zapewnia to:

- monitorowanie miejsca znajdowania się danego narzędzia
- śledzenie narzędzia na drodze szpital-sterylizatornia
- zawarcie pełnej informacji o wyrobie na małej powierzchni
- oszczędność czasu przy organizacji pracy szpitala.

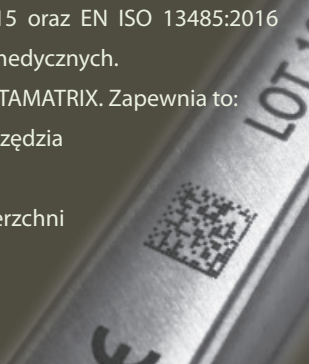

40 years of experience

The history of the brand dates back to 1981, when Mr. Mikołaj Charkiewicz established the ChM company. In 1985 the production of first simple surgical instruments had started and a year after, in 1986, the design department was created. Its main task was to develop the design and manufacture technology of products used in orthopedics and traumatology. Although the available knowledge about materials, technology or functioning of medical tools was limited back then in Poland, the production of first simple metal implants was started in the beginning of the 1990s. In 2004, the company transformed into the ChM limited liability company.

We owe this success of the company to the initial limitations. These limitations contributed to constant search, self-education and creation of own research base. Today's cooperation incorporates both medical environment and research institutions in the country and abroad. 40 years of experience has taught us to listen and respond to the needs of dynamically developing medicine. This whole period was a time of development based on mutual trust. Thanks to this kind of relationship we are able to expend our product portfolio by creating a new solution.

The instruments we offer are medical devices of the highest quality manufactured in accordance with the applicable version of EN ISO 9001:2015 and EN ISO 13485:2016 and in accordance with Directive 93/42/EEC concerning medical products. Our instruments are marked in a special way with DATAMATRIX code. The code provides:

- monitoring of a particular instrument's location
- tracking an instrument on the hospital - sterilization path
- providing full information about a product on a small area
- saving time in the organization of hospital work.

40 лет опыта

История бренда берёт своё начало в 1981 году, когда Миколай Харкевич основал компанию ChM. В 1985 году было налажено производство простых хирургических инструментов, а уже год спустя, в 1986 году, было создано конструкторское бюро, задачей которого стала разработка конструкции и технологии производства изделий, используемых в ортопедии и травматологии. Несмотря на то что доступные на то время в Польше знания на тему материалов, технологии и функционирования медицинских инструментов были сильно ограничены, уже в начале 90-ых годов компания начала производство первых простых имплантатов из металла. В 2004 году компания была преобразована в организацию с правосубъектностью под названием ChM общество с ограниченной ответственностью.

Нынешнему успеху компании мы обязаны начальным ограничениям. Это они стали причиной непрерывного поиска, саморазвития и создания собственной исследовательской базы. Сегодня сотрудничество охватывает как медицинское общество, так и исследовательские учреждения в Польше и за рубежом. 40-а летний опыт научил нас слушать и реагировать на нужды динамично развивающейся медицины. Весь этот промежуток времени – это развитие, основанное на отношениях взаимного доверия. Это благодаря им мы можем расширять ассортимент наших продуктов.

Предлагаемые нами инструменты – это медицинские изделия высочайшего качества, изготовленные в соответствии с действующей версией стандартов EN ISO 9001:2015 и EN ISO 13485:2016 и в соответствии с Директивой 93/42/EEC о медицинских изделиях. Наши инструменты особым образом маркированы кодом DATAMATRIX. Это обеспечивает:

- мониторинг местонахождения данного инструмента
- отслеживание инструмента на пути больница – стерилизация
- полную информацию об изделии на небольшой поверхности
- экономию времени при организации работы больницы.

TRZONKI SCALPEL HANDLES РУЧКИ.....	7
IGŁY / PROWADNIKI NEEDLES / CONDUCTORS ИГЛЫ / ПРОВОДНИК.....	8
IGŁOTRZYMACZE NEEDLE HOLDERS ИГЛОДЕРЖАТЕЛИ.....	19
NOŻYCZKI SURGICAL SCISSORS НОЖНИЦЫ.....	28
PINCETY FORCEPS ПИНЦЕТЫ.....	46
KLESZCZYKI FORCEPS ЗАЖИМЫ.....	58
SONDY ŻYLNE VASCULAR DILATORS ИНСТРУМЕНТЫ ДЛЯ ДИЛЯТАЦИИ КРОВЕНОСНЫХ СОСУДОВ.....	88
SONDY DIRECTORS ЗОНДЫ.....	89
KLESZCZYKI / SONDY DO KAMIENI FORCEPS / GALL STONE PROBES ЗАЖИМЫ / ЗОНДЫ ДЛЯ УДАЛЕНИЯ КАМНЕЙ.....	90
ODBYTNICZE KLESZCZYKI DO BIOPSI RECTAL BIOPSY PUNCHES ЗАЖИМЫ ДЛЯ БИОПСИИ.....	96
POZOSTAŁE KLESZCZYKI OTHER FORCEPS ДРУГИЕ ЗАЖИМЫ.....	98
NAKI HOOKS ХАКИ.....	100
ROZWIERACZE RETRACTORS РАСШИРИТЕЛИ.....	140







Nr 3	Nr 3L	Nr 3L	Nr 4	Nr 4L	Nr 4L	Nr 7
30.0041	30.0042	30.0098	30.0043	30.0044	30.0099	30.0046
125 mm	210 mm	210 mm	135 mm	220 mm	220 mm	160 mm



30.4350

Uchwyt do zdejmowania ostrza
Scalpel blade remover
Держатель для снятия лезвия

Opakowanie 12 sztuk • Package 12 pieces • Упаковка 12 штук

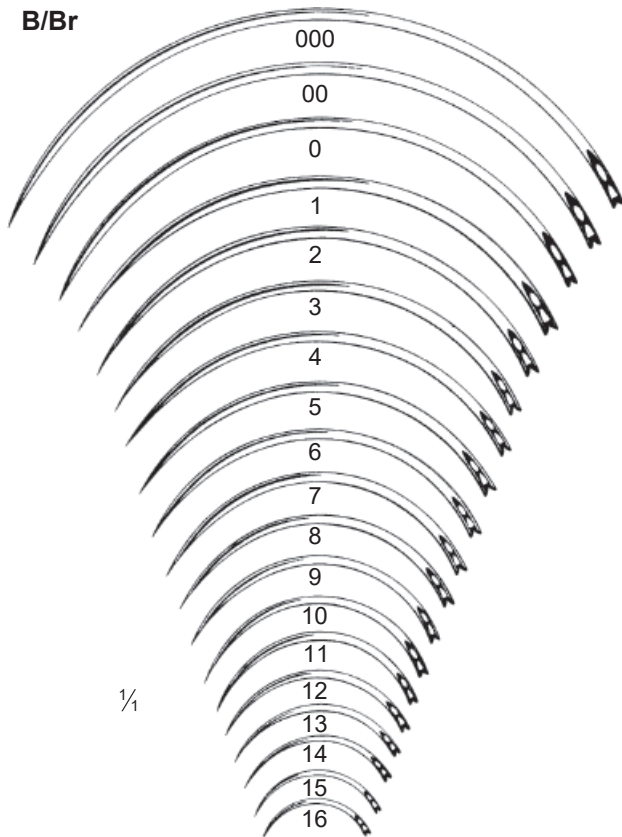

B		Rozmiar Size Размер	Br	
30.0300	30.0319	000	30.0338	30.0357
30.0301	30.0320	00	30.0339	30.0358
30.0302	30.0321	0	30.0340	30.0359
30.0303	30.0322	1	30.0341	30.0360
30.0304	30.0323	2	30.0342	30.0361
30.0305	30.0324	3	30.0343	30.0362
30.0306	30.0325	4	30.0344	30.0363
30.0307	30.0326	5	30.0345	30.0364
30.0308	30.0327	6	30.0346	30.0365
30.0309	30.0328	7	30.0347	30.0366
30.0310	30.0329	8	30.0348	30.0367
30.0311	30.0330	9	30.0349	30.0368
30.0312	30.0331	10	30.0350	30.0369
30.0313	30.0332	11	30.0351	30.0370
30.0314	30.0333	12	30.0352	30.0371
30.0315	30.0334	13	30.0353	30.0372
30.0316	30.0335	14	30.0354	30.0373
30.0317	30.0336	15	30.0355	30.0374
30.0318	30.0337	16	30.0356	30.0375

G		Rozmiar Size Размер	Gr	
30.0376	30.0395	000	30.0414	30.0433
30.0377	30.0396	00	30.0415	30.0434
30.0378	30.0397	0	30.0416	30.0435
30.0379	30.0398	1	30.0417	30.0436
30.0380	30.0399	2	30.0418	30.0437
30.0381	30.0400	3	30.0419	30.0438
30.0382	30.0401	4	30.0420	30.0439
30.0383	30.0402	5	30.0421	30.0440
30.0384	30.0403	6	30.0422	30.0441
30.0385	30.0404	7	30.0423	30.0442
30.0386	30.0405	8	30.0424	30.0443
30.0387	30.0406	9	30.0425	30.0444
30.0388	30.0407	10	30.0426	30.0445
30.0389	30.0408	11	30.0427	30.0446
30.0390	30.0409	12	30.0428	30.0447
30.0391	30.0410	13	30.0429	30.0448
30.0392	30.0411	14	30.0430	30.0449
30.0393	30.0412	15	30.0431	30.0450
30.0394	30.0413	16	30.0432	30.0451

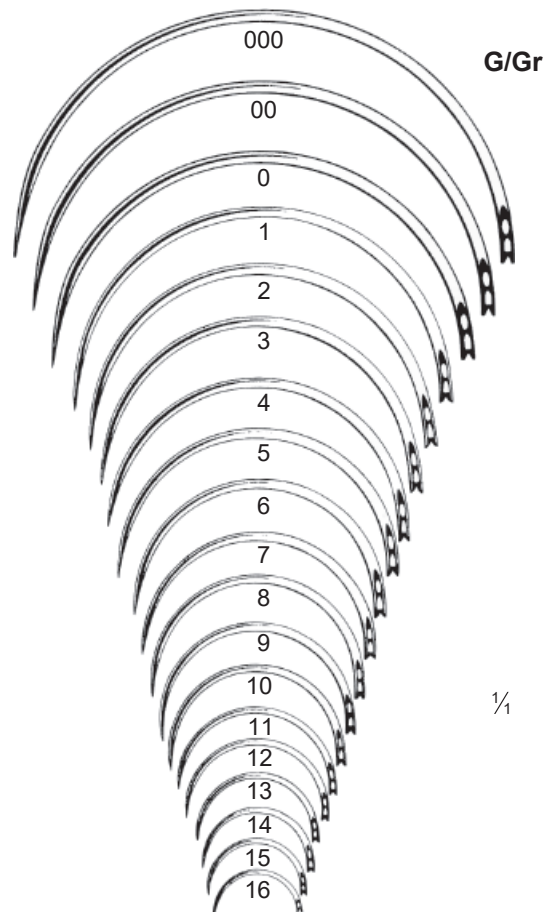

Ga/Gar

Опаковка 12 sztuk • Package 12 pieces • Упаковка 12 штук

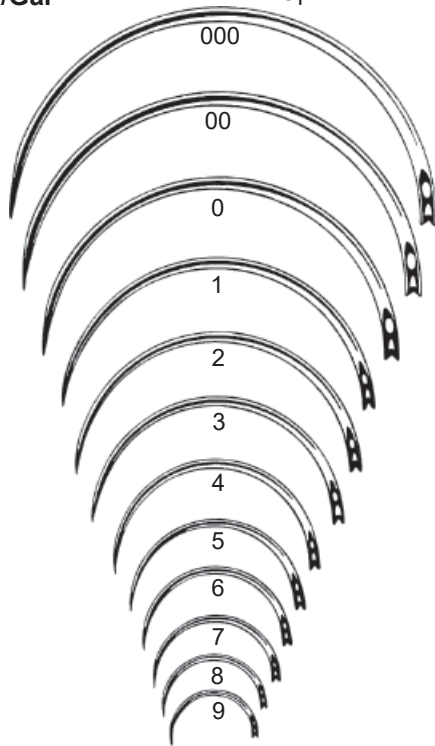

Ga		Rozmiar Size Размер	Gar	
30.0452	30.0464	000	30.0476	30.0488
30.0453	30.0465	00	30.0477	30.0489
30.0454	30.0466	0	30.0478	30.0490
30.0455	30.0467	1	30.0479	30.0491
30.0456	30.0468	2	30.0480	30.0492
30.0457	30.0469	3	30.0481	30.0493
30.0458	30.0470	4	30.0482	30.0494
30.0459	30.0471	5	30.0483	30.0495
30.0460	30.0472	6	30.0484	30.0496
30.0461	30.0473	7	30.0485	30.0497
30.0462	30.0474	8	30.0486	30.0498
30.0463	30.0475	9	30.0487	30.0499

E		Rozmiar Size Размер
30.0524	30.0533	000
30.0525	30.0534	00
30.0526	30.0535	0
30.0527	30.0536	1
30.0528	30.0537	2
30.0529	30.0538	3
30.0530	30.0539	4
30.0531	30.0540	5
30.0532	30.0541	6

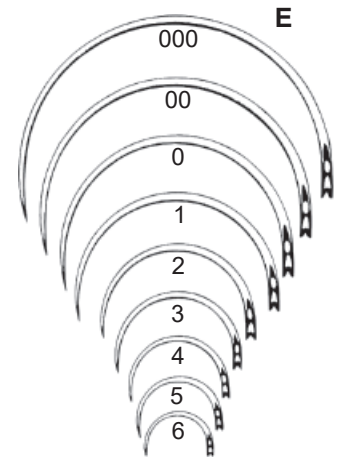

Keith

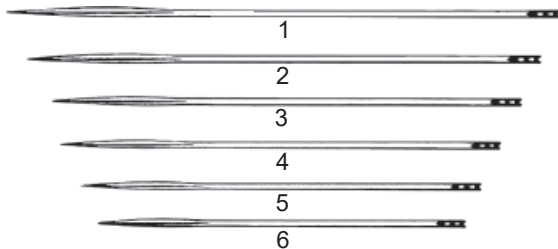

Keith		Rozmiar Size Размер	Keith	
30.0500	30.0506	1	30.0512	30.0518
30.0501	30.0507	2	30.0513	30.0519
30.0502	30.0508	3	30.0514	30.0520
30.0503	30.0509	4	30.0515	30.0521
30.0504	30.0510	5	30.0516	30.0522
30.0505	30.0511	6	30.0517	30.0523

Pc

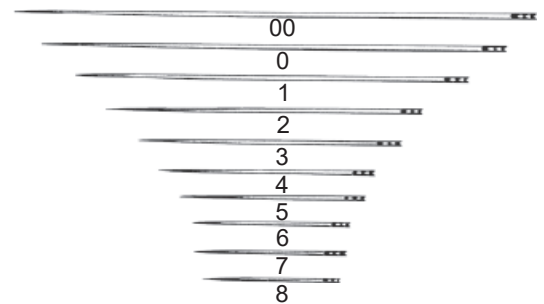

Pa

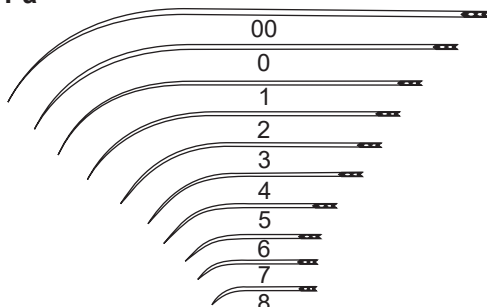

Pa		Rozmiar Size Размер
30.0580	30.0590	00
30.0581	30.0591	0
30.0582	30.0592	1
30.0583	30.0593	2
30.0584	30.0594	3
30.0585	30.0595	4
30.0586	30.0596	5
30.0587	30.0597	6
30.0588	30.0598	7
30.0589	30.0599	8

Pc		Rozmiar Size Размер
30.0600	30.0610	00
30.0601	30.0611	0
30.0602	30.0612	1
30.0603	30.0613	2
30.0604	30.0614	3
30.0605	30.0615	4
30.0606	30.0616	5
30.0607	30.0617	6
30.0608	30.0618	7
30.0609	30.0619	8

Opakowanie 12 sztuk • Package 12 pieces • Упаковка 12 штук

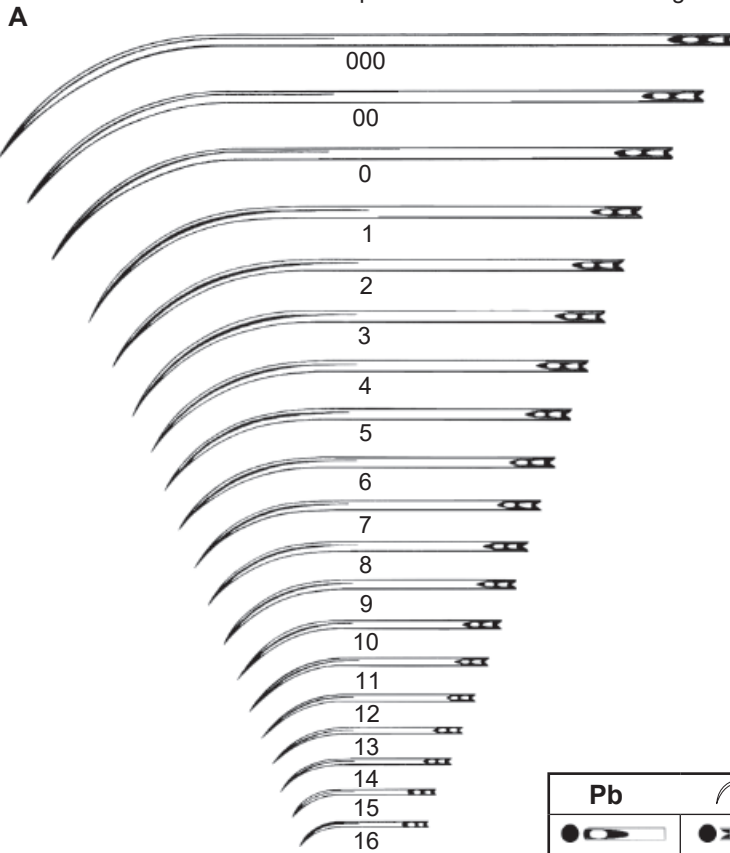

A		Rozmiar Size Размер
30.0542	30.0561	000
30.0543	30.0562	00
30.0544	30.0563	0
30.0545	30.0564	1
30.0546	30.0565	2
30.0547	30.0566	3
30.0548	30.0567	4
30.0549	30.0568	5
30.0550	30.0569	6
30.0551	30.0570	7
30.0552	30.0571	8
30.0553	30.0572	9
30.0554	30.0573	10
30.0555	30.0574	11
30.0556	30.0575	12
30.0557	30.0576	13
30.0558	30.0577	14
30.0559	30.0578	15
30.0560	30.0579	16

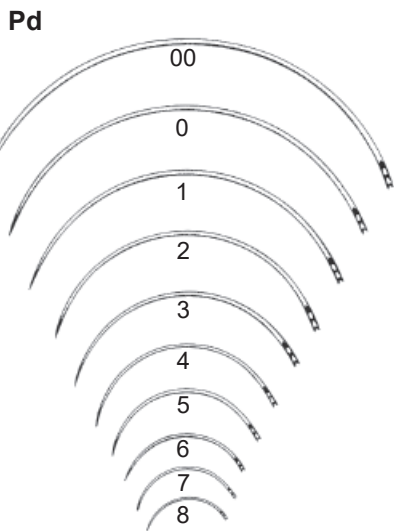

Pb		Rozmiar Size Размер
30.0620	30.0630	00
30.0621	30.0631	0
30.0622	30.0632	1
30.0623	30.0633	2
30.0624	30.0634	3
30.0625	30.0635	4
30.0626	30.0636	5
30.0627	30.0637	6
30.0628	30.0638	7
30.0629	30.0639	8

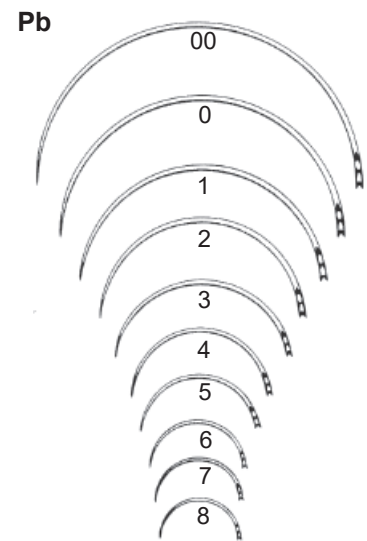

Pd		Rozmiar Size Размер
30.0640	30.0651	00
30.0641	30.0652	0
30.0642	30.0653	1
30.0643	30.0654	2
30.0645	30.0655	3
30.0646	30.0656	4
30.0647	30.0657	5
30.0648	30.0658	6
30.0649	30.0659	7
30.0650	30.0660	8

Oa		Rozmiar Size Размер
30.0661	30.0667	0
30.0662	30.0668	1
30.0663	30.0669	2
30.0664	30.0670	3
30.0665	30.0671	4
30.0666	30.0672	5



Ob		Rozmiar Size Размер
30.0673	30.0679	0
30.0674	30.0680	1
30.0675	30.0681	2
30.0676	30.0682	3
30.0677	30.0683	4
30.0678	30.0684	5

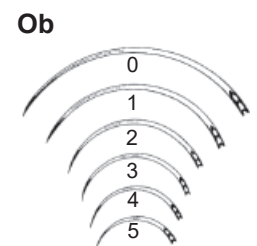

Opakowanie 12 sztuk • Package 12 pieces • Упаковка 12 штук

Og

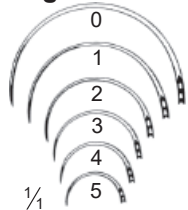

Og		1/2	Rozmiar Size Размер
30.0685	30.0691		0
30.0686	30.0692		1
30.0687	30.0693		2
30.0688	30.0694		3
30.0689	30.0695		4
30.0690	30.0696		5

Kalt

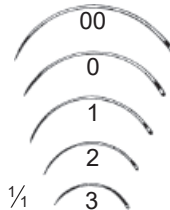

Kalt		3/8	Rozmiar Size Размер
30.0697			00
30.0698			0
30.0699			1
30.0700			2
30.0701			3

Payr

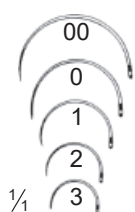

Payr		1/2	Rozmiar Size Размер
30.0702			00
30.0703			0
30.0704			1
30.0705			2
30.0706			3

Payr

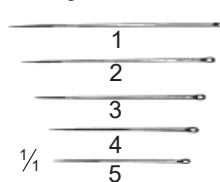

Payr		Rozmiar Size Размер
30.0707		1
30.0708		2
30.0709		3
30.0710		4
30.0711		5

Ferguson

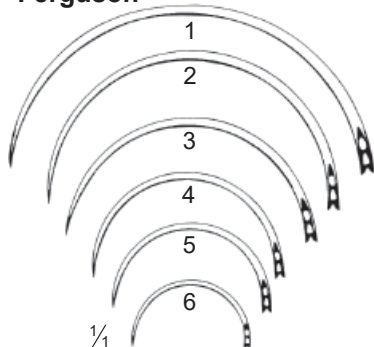

Ferguson		1/2	Rozmiar Size Размер
30.0712	30.0718		1
30.0713	30.0719		2
30.0714	30.0720		3
30.0715	30.0721		4
30.0716	30.0722		5
30.0717	30.0723		6

Mayo

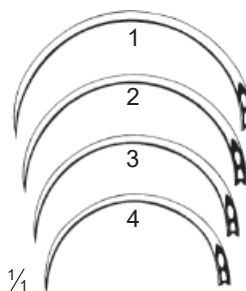

Mayo		1/2	Rozmiar Size Размер
30.0724	30.0728		1
30.0725	30.0729		2
30.0726	30.0730		3
30.0727	30.0731		4



Kasetka - komplet
Case - set
Упаковка - комплект
30.2824



Kasetka wewnętrzna perforowana
Perforated interior case
Упаковка внутренняя
30.2825



210x125x17 mm
30.2824.210



150x95x13 mm
30.2824.150



Kronecker

30.4127 130 mm 30.4128

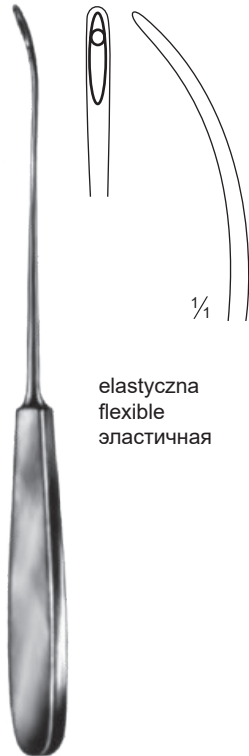

elastyczna
flexible
эластичная

30.4129
200 mm



Cooper
30.4131
190 mm

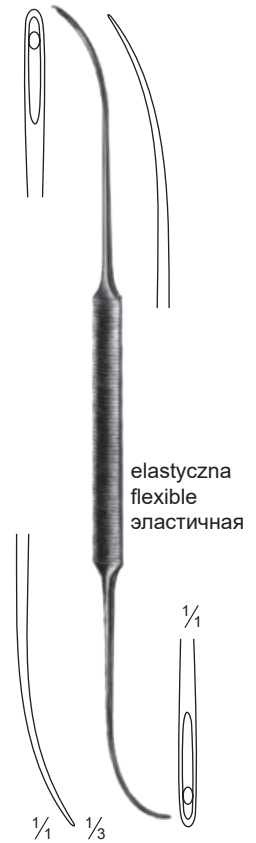

elastyczna
flexible
эластичная

Schmieden-Dick
30.4132
320 mm

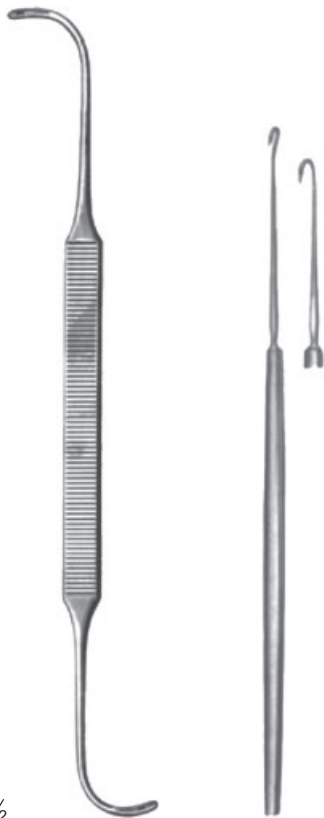

Schmieden
30.4133
210 mm



Hessberg
30.4134
150 mm



30.4135
prawa
right
правая

30.4136
lewa
left
левая

Woodruff
130 mm

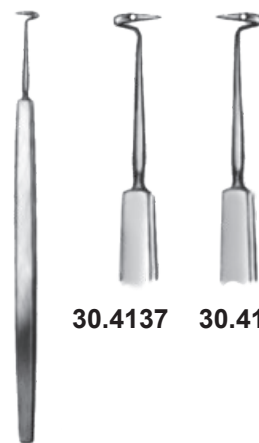

30.4137 30.4138

De la Roza
120 mm

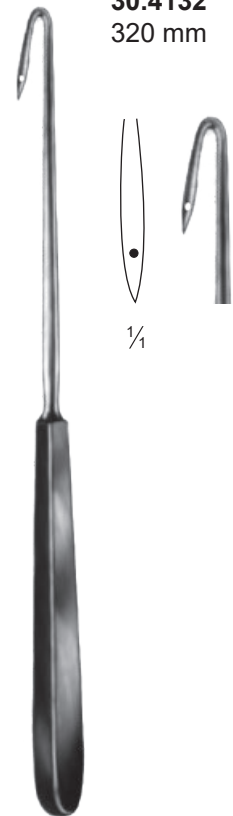

Narath
30.4139
220 mm

Deshamps

30.4140

dla praworęcznych, tępą
for the right hand, blunt
для правой, тупая
200 mm



Deshamps

30.4141

dla leworęcznych, tępą
for the left hand, blunt
для левой, тупая
200 mm



Deshamps

30.4142

dla praworęcznych, ostra
for the right hand, sharp
для правой, острая
200 mm



Deshamps

30.4143

dla leworęcznych, ostra
for the left hand, sharp
для левой, острая
200 mm



Deshamps

30.4144

dla praworęcznych, tępą
for the right hand, blunt
для правой, тупая
200 mm



Deshamps

30.4145

dla leworęcznych, tępą
for the left hand, blunt
для левой, тупая
200 mm



Deshamps

30.4146

dla praworęcznych, ostra
for the right hand, sharp
для правой, острая
200 mm



Deshamps

30.4147

dla leworęcznych, ostra
for the left hand, sharp
для левой, острая
200 mm



**Deshamps
30.4148**

dla praworęcznych, tępą
for the right hand, blunt
для правой, тупая
210 mm



**Deshamps
30.4149**

dla leworęcznych, tępą
for the left hand, blunt
для левой, тупая
210 mm



**Deshamps
30.4150**

dla praworęcznych, ostrą
for the right hand, sharp
для правой, острая
210 mm



**Deshamps
30.4151**

dla leworęcznych, ostrą
for the left hand, sharp
для левой, острая
210 mm



**Deshamps
30.4152**

dla praworęcznych, tępą
for the right hand, blunt
для правой, тупая
240 mm



**Deshamps
30.4153**

dla leworęcznych, tępą
for the left hand, blunt
для левой, тупая
240 mm



Deshamps

30.4154

dla praworęcznych, tępa
for the right hand, blunt
для правой, тупая
270 mm



Deshamps

30.4155

dla leworęcznych, tępa
for the left hand, blunt
для левой, тупая
270 mm

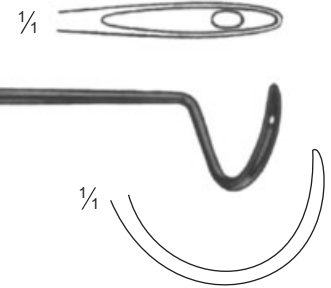

Deshamps

30.4156

dla praworęcznych, ostra
for the right hand, sharp
для правой, острая
270 mm

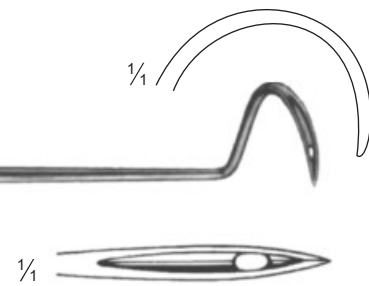

Deshamps

30.4157

dla leworęcznych, ostra
for the left hand, sharp
для левой, острая
270 mm

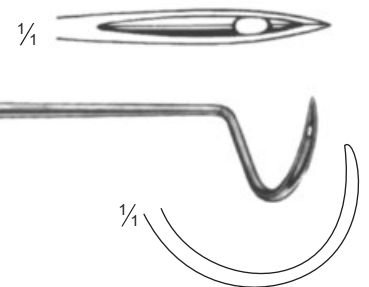

Deshamps

30.4158

dla praworęcznych, tępa
for the right hand, blunt
для правой, тупая
280 mm

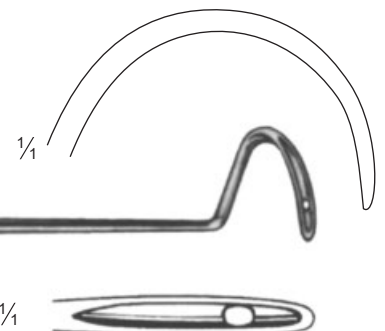

Deshamps

30.4159

dla leworęcznych, tępa
for the left hand, blunt
для левой, тупая
280 mm

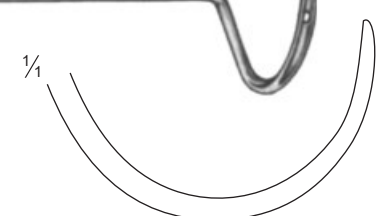

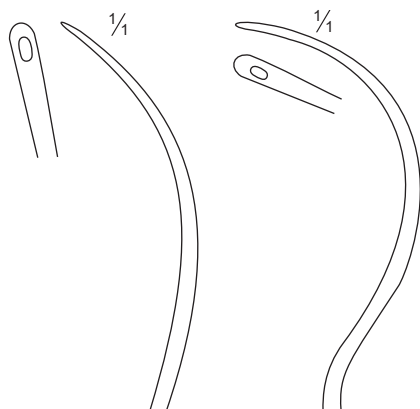

30.4160

30.4161

Brunner
300 mm

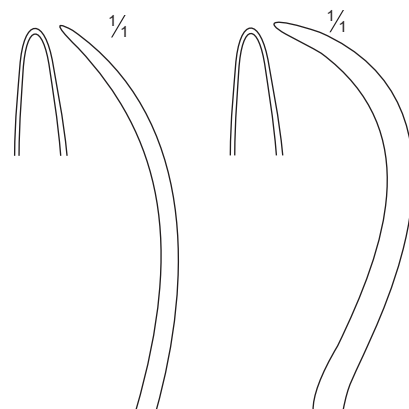

30.4162

30.4163

Brunner
300 mm

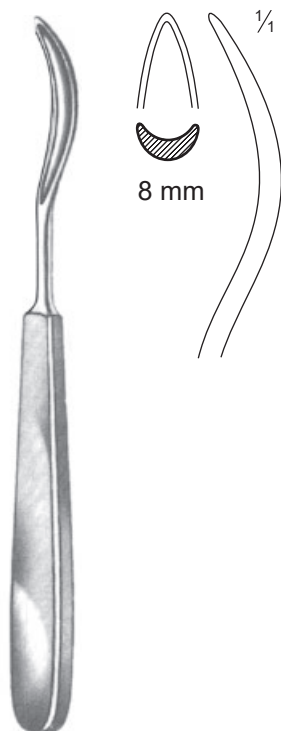

Schmieden
30.4164
190 mm

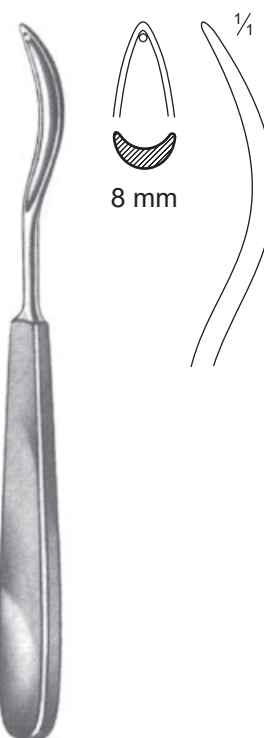

Schmieden-Payr
30.4165
190 mm



König
30.4166
195 mm

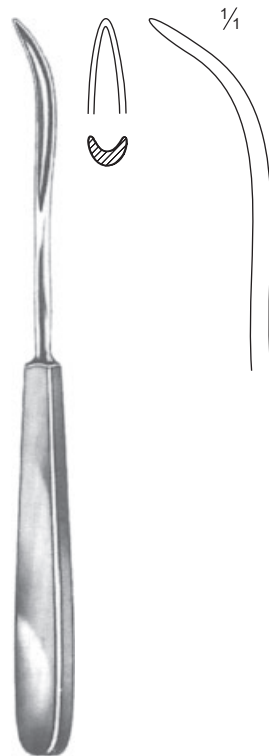

König
30.4167
195 mm



König
30.4168
200 mm



Payr
30.4184
220 mm

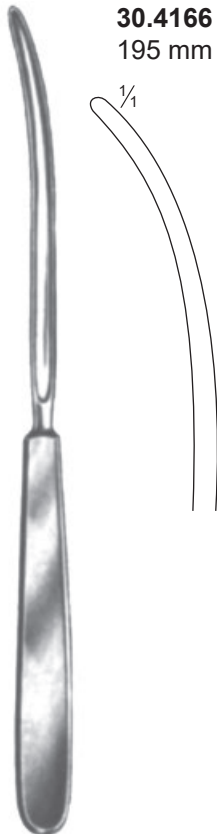

Payr
30.4185
220 mm

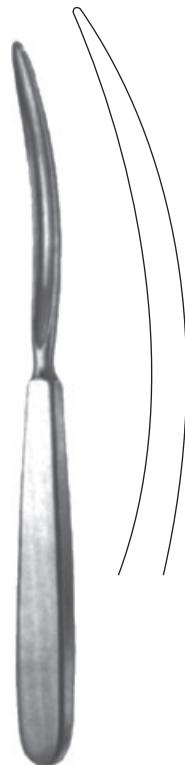

30.4186
195 mm



30.4215
150 mm

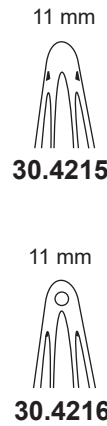

30.4216
11 mm

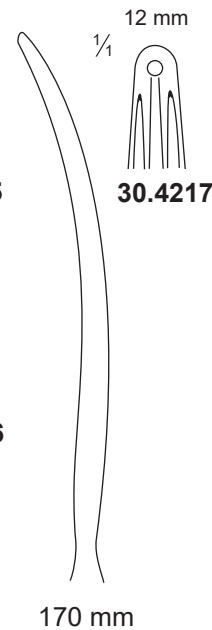

170 mm

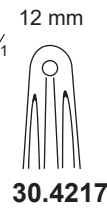

Brunner-Ferrozell
30.4218 180 mm
30.4219 270 mm





Reverdin
140 mm



30.4187



30.4188



30.4189



30.4190



Reverdin



30.4191
195 mm



30.4192
195 mm



30.4193
195 mm



30.4194
195 mm



30.4195
225 mm



30.4196
225 mm



30.4197
225 mm



30.4198
225 mm

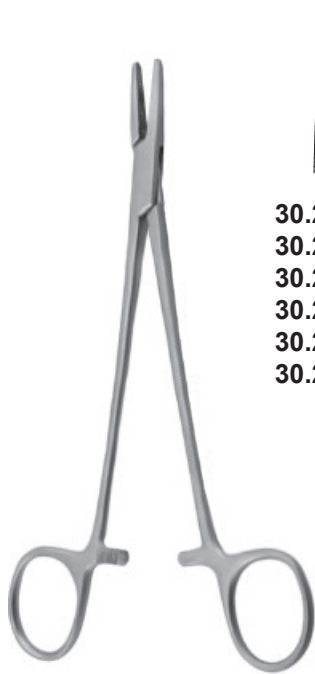

Mayo-Hegar

- | | |
|-----------------------|----------------|
| 30.2700 140 mm | |
| 30.2701 160 mm | 30.2706 |
| 30.2702 180 mm | 30.2707 |
| 30.2703 200 mm | 30.2708 |
| 30.2704 240 mm | 30.2709 |
| 30.2705 260 mm | 30.2710 |



Mayo-Hegar

- | |
|-----------------------|
| 30.2711 160 mm |
| 30.2712 180 mm |
| 30.2713 200 mm |
- delikatne
slender
деликатные

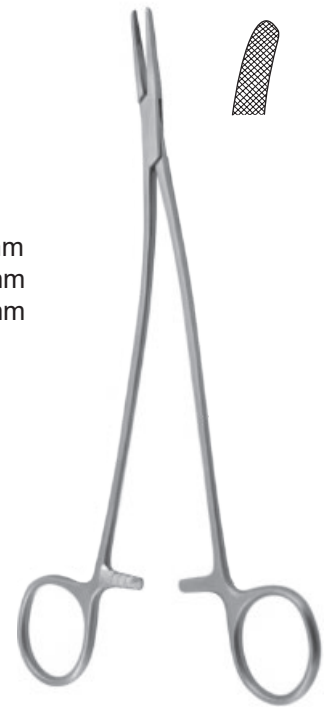

Stratte
30.2714
230 mm

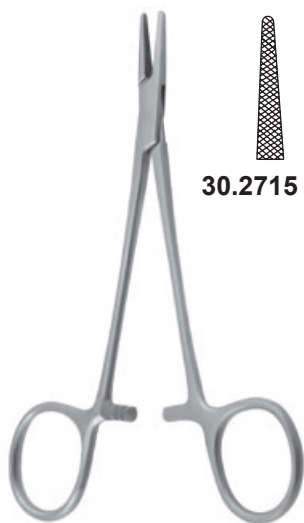

Halsey
130 mm

- | | |
|----------------|----------------|
| 30.2715 | 30.2716 |
|----------------|----------------|

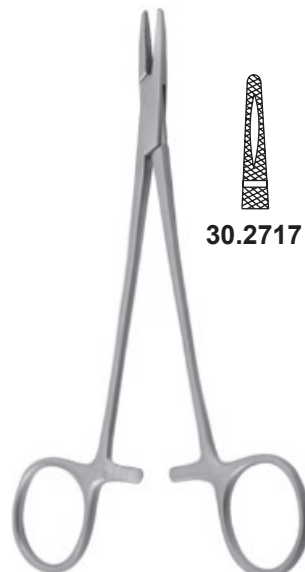

Crile-Wood
150 mm

- | | |
|----------------|----------------|
| 30.2717 | 30.2718 |
|----------------|----------------|

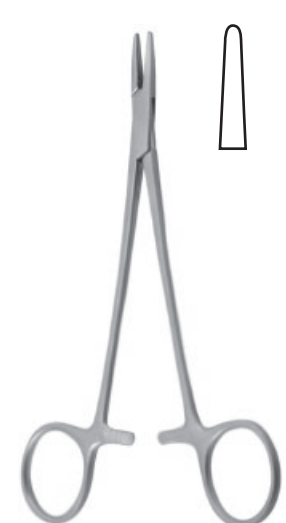

Webster
30.2719
130 mm



Collier
30.2720
125 mm



M.G.H
30.2721
170 mm



Sarot
30.2722 180 mm
30.2723 260 mm

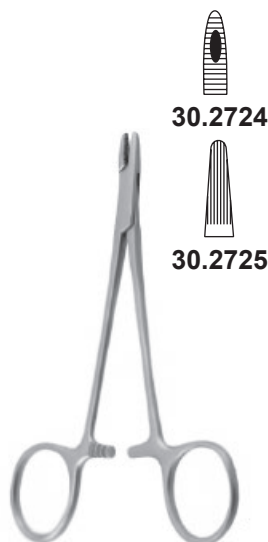

Derf
125 mm



Brown
30.2730 130 mm
30.2731 180 mm

igłotrzymacze z nożyczkami • needle holders with scissors • иглодержатели с ножницами

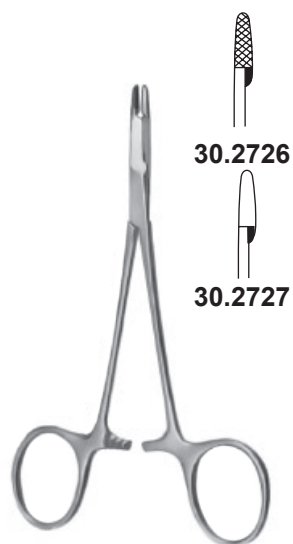

Baby-Olsen-Hegar
115 mm



Olsen-Hegar
30.2728
140 mm



Gillies
30.2729
160 mm

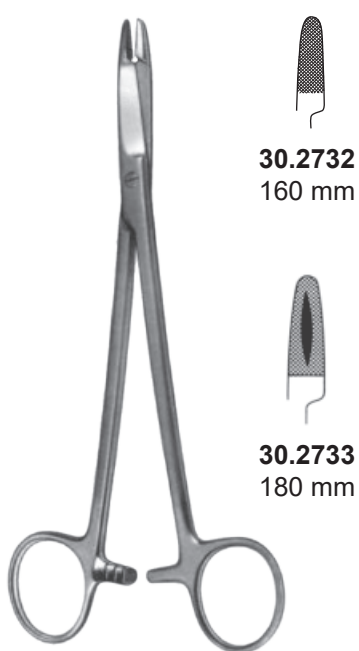

Olsen-Hegar

30.2732
160 mm

30.2733
180 mm



Olsen-Hegar
30.2680
140 mm



Olsen-Hegar
30.2681
170 mm

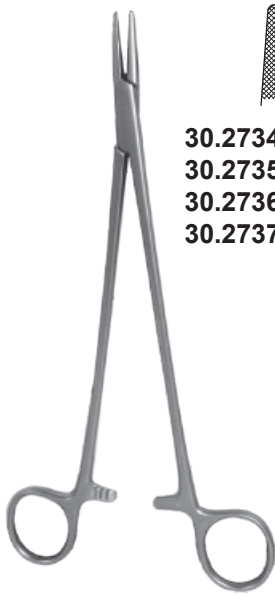

30.2734 150 mm
30.2735 180 mm
30.2736 200 mm
30.2737 230 mm

Crile-Wood



30.2738
180 mm

Adson



30.2739
150 mm

Crile



Heaney
30.2740 210 mm
30.2741 260 mm

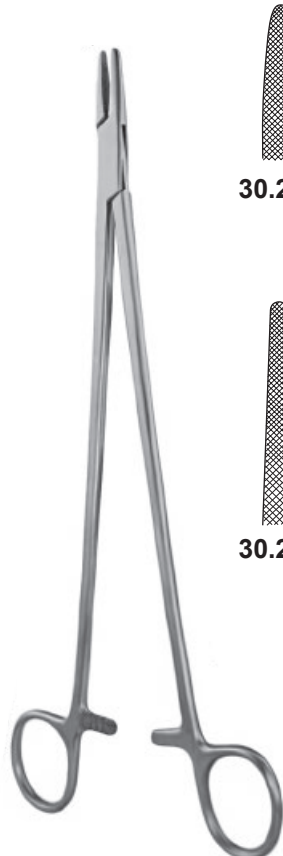

30.2742

30.2743

Wangenstein
270 mm



Finochietto
30.2744
270 mm



Masson
30.2745
270 mm



30.2746 170 mm
30.2747 200 mm



30.2748 170 mm
30.2749 200 mm

Mathieu



30.2750 140 mm **30.2753**
30.2751 170 mm **30.2754**
30.2752 200 mm **30.2755**



30.2756 140 mm
30.2757 170 mm

Mathieu



Hegar-Baum
30.2758
140 mm

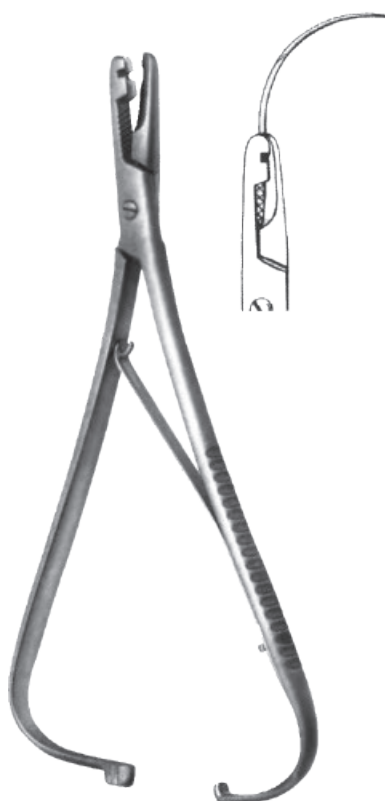

Ermold
30.2683
170 mm



Jameson
30.2684
230 mm

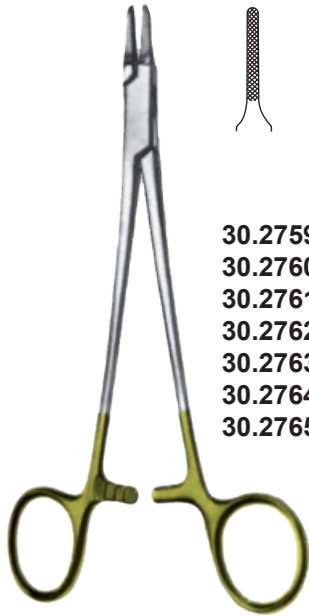

- 30.2759** 130 mm 1,2 mm
- 30.2760** 145 mm 1,4 mm
- 30.2761** 160 mm 1,5 mm
- 30.2762** 180 mm 1,7 mm
- 30.2763** 200 mm 2,0 mm
- 30.2764** 230 mm 2,2 mm
- 30.2765** 260 mm 2,4 mm

French

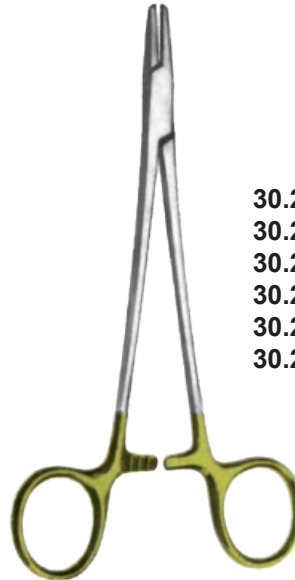

- 30.2766** 140 mm
- 30.2767** 160 mm
- 30.2768** 180 mm
- 30.2769** 200 mm
- 30.2770** 230 mm
- 30.2771** 260 mm
- 30.2690** 180 mm
- 30.2691** 200 mm
- 30.2692** 230 mm
- 30.2693** 260 mm

Mayo-Hegar



30.2772

30.2773

Halsey
130 mm



30.2774

Webster
130 mm



30.2775

Mayo-Hegar
300 mm

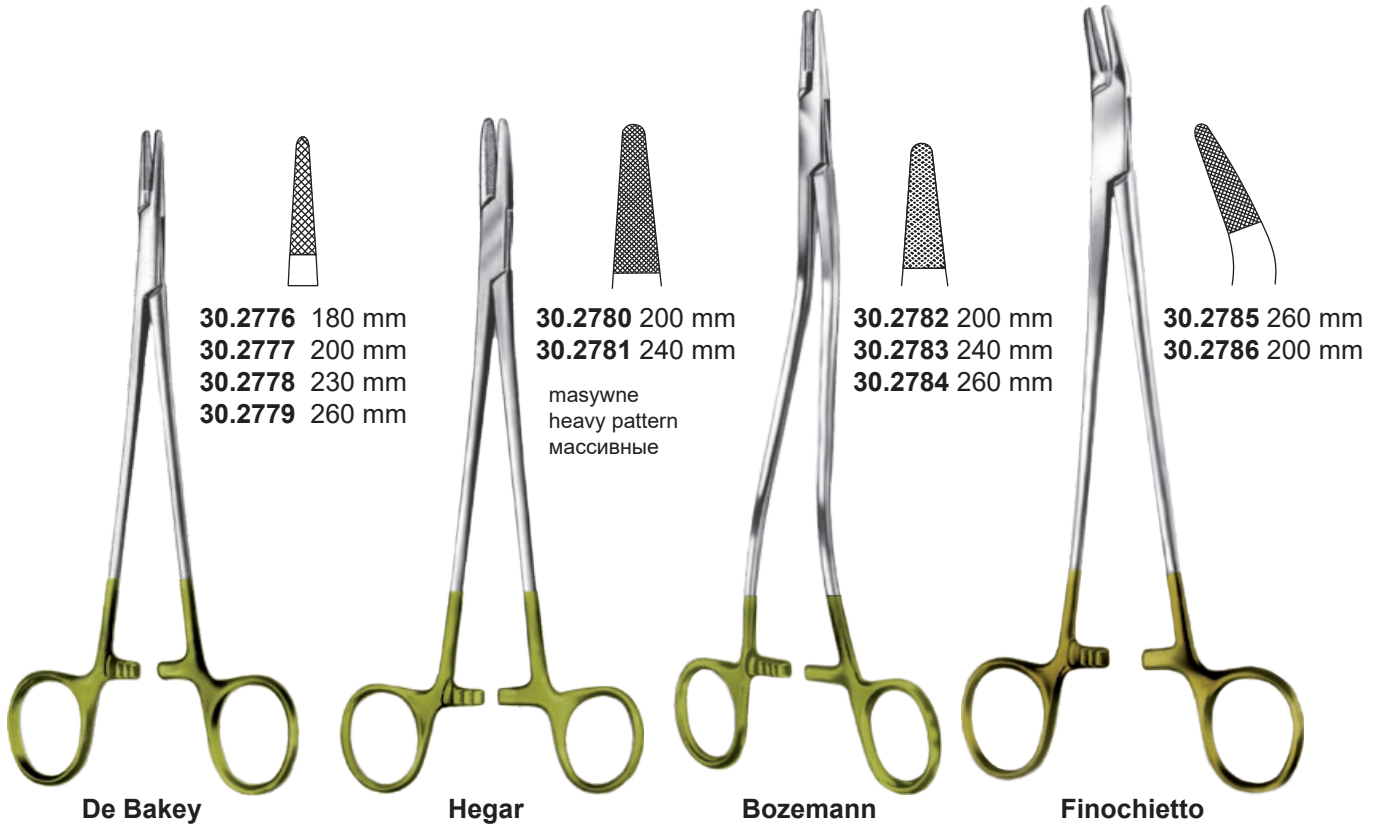



30.2795 150 mm
 30.2796 180 mm
 30.2797 200 mm
 30.2798 230 mm
 30.2799 260 mm

Crile-Wood

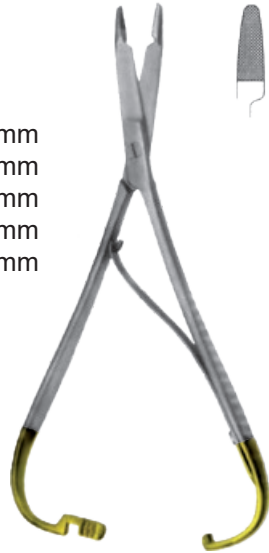

Olsen- Mathieu

30.2694
 140 mm



Olsen- Mathieu

30.2695 170 mm
 30.2696 200 mm



Mathieu

30.2800 170 mm
 30.2801 200 mm



30.2802 170 mm
 30.2803 200 mm

masywne
 heavy pattern
 массивные

Mathieu



30.2804 140 mm
 30.2805 170 mm
 30.2806 200 mm

Mathieu

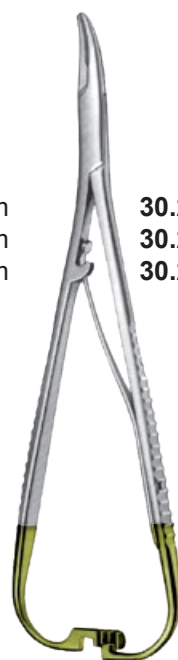

30.2807 140 mm
 30.2808 170 mm
 30.2809 200 mm

Mathieu

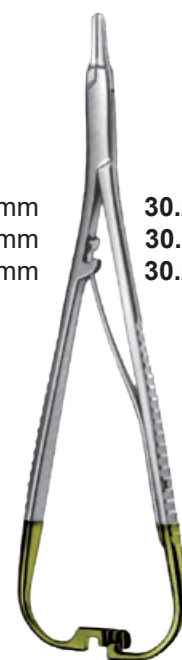

30.2810 140 mm
 30.2811 170 mm
 30.2812 200 mm

French- Mathieu



Derf

30.2814
125 mm

Baumgartner

30.2815.000 130 mm
30.2815.140 140 mm

Heaney

30.2816 200 mm
30.2817 260 mm

Sarot

30.2818 180 mm
30.2819 200 mm
30.2820 260 mm



Masson

30.2821
270 mm



Baby-Olsen-Hegar

30.2822 115 mm
30.2823 115 mm



Castroviejo

30.2685.140 140 mm
30.2685.180 180 mm
30.2685.220 220 mm

30.2686.140
30.2686.180
30.2686.220

30.2687.140 140 mm
30.2688.140

30.2689.140 140 mm
30.2689.180 180 mm
 bez zamka
 without ratchet
 без замка

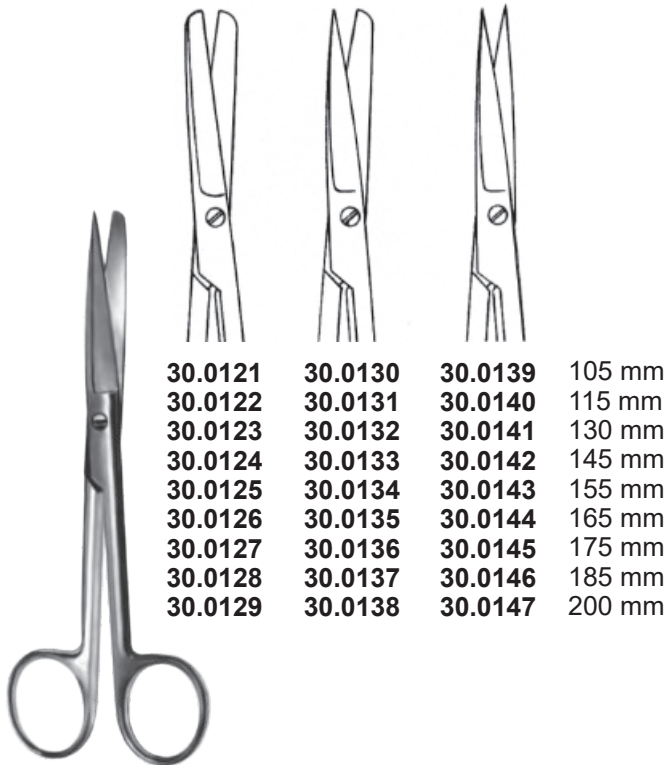

30.0121	30.0130	30.0139	105 mm
30.0122	30.0131	30.0140	115 mm
30.0123	30.0132	30.0141	130 mm
30.0124	30.0133	30.0142	145 mm
30.0125	30.0134	30.0143	155 mm
30.0126	30.0135	30.0144	165 mm
30.0127	30.0136	30.0145	175 mm
30.0128	30.0137	30.0146	185 mm
30.0129	30.0138	30.0147	200 mm

Standard
proste · straight · прямые

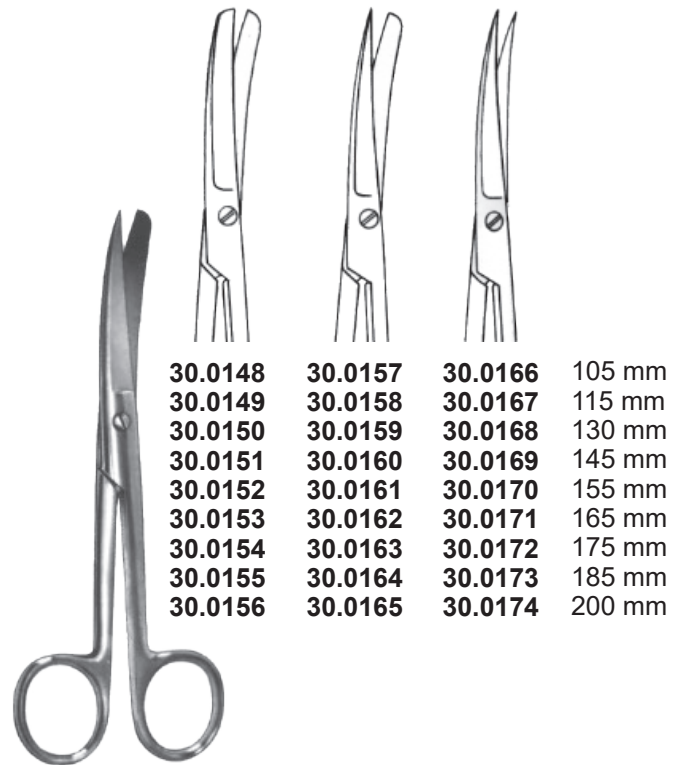

30.0148	30.0157	30.0166	105 mm
30.0149	30.0158	30.0167	115 mm
30.0150	30.0159	30.0168	130 mm
30.0151	30.0160	30.0169	145 mm
30.0152	30.0161	30.0170	155 mm
30.0153	30.0162	30.0171	165 mm
30.0154	30.0163	30.0172	175 mm
30.0155	30.0164	30.0173	185 mm
30.0156	30.0165	30.0174	200 mm

Standard
odgięte · curved · изогнутые

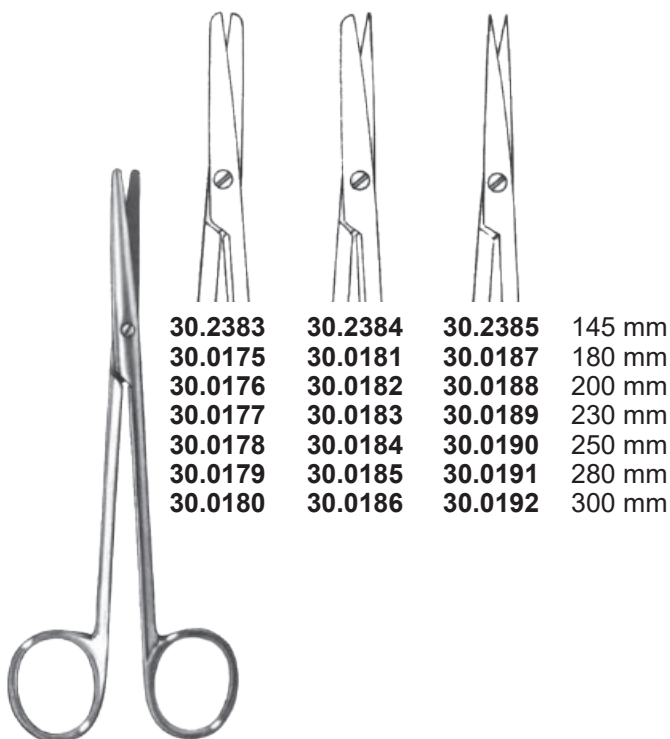

30.2383	30.2384	30.2385	145 mm
30.0175	30.0181	30.0187	180 mm
30.0176	30.0182	30.0188	200 mm
30.0177	30.0183	30.0189	230 mm
30.0178	30.0184	30.0190	250 mm
30.0179	30.0185	30.0191	280 mm
30.0180	30.0186	30.0192	300 mm

Metzenbaum
proste · straight · прямые

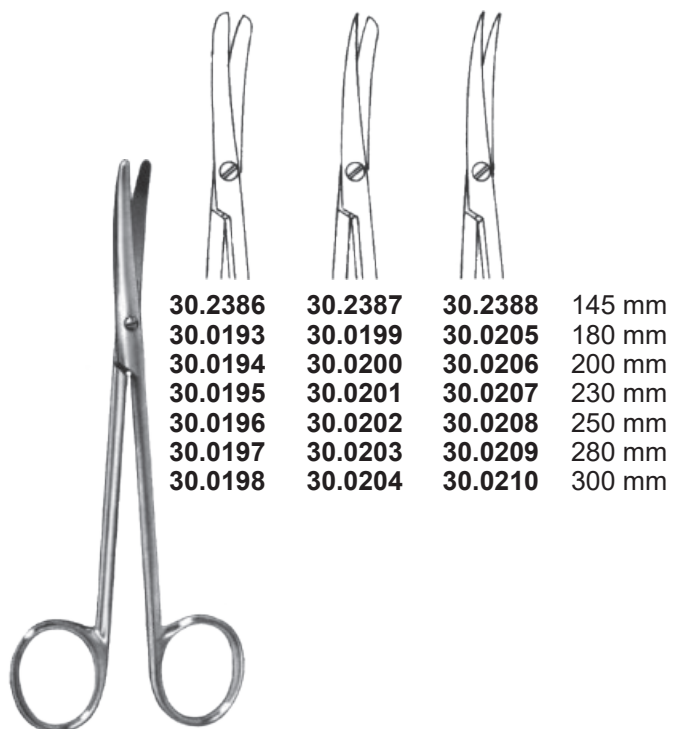

30.2386	30.2387	30.2388	145 mm
30.0193	30.0199	30.0205	180 mm
30.0194	30.0200	30.0206	200 mm
30.0195	30.0201	30.0207	230 mm
30.0196	30.0202	30.0208	250 mm
30.0197	30.0203	30.0209	280 mm
30.0198	30.0204	30.0210	300 mm

Metzenbaum
odgięte · curved · изогнутые



30.2328.090	90 mm	30.2329.090
30.2328.010	100 mm	30.2329.010
30.2328.011	110 mm	30.2329.011
30.2328.012	120 mm	30.2329.012



30.2331	150 mm	30.2335
30.2332	170 mm	30.2336
30.2333	230 mm	30.2337



Mayo



30.2338	150 mm	30.2341
30.2339	170 mm	30.2342
30.2340	210 mm	30.2343



Mayo-Stille



Graziil



30.2344	30.2345
----------------	----------------



30.2346	30.2347
----------------	----------------



30.2348	130 mm
30.2349	145 mm



30.2350	30.2351
----------------	----------------



30.2352	30.2353
----------------	----------------



30.2354	130 mm
30.2355	145 mm

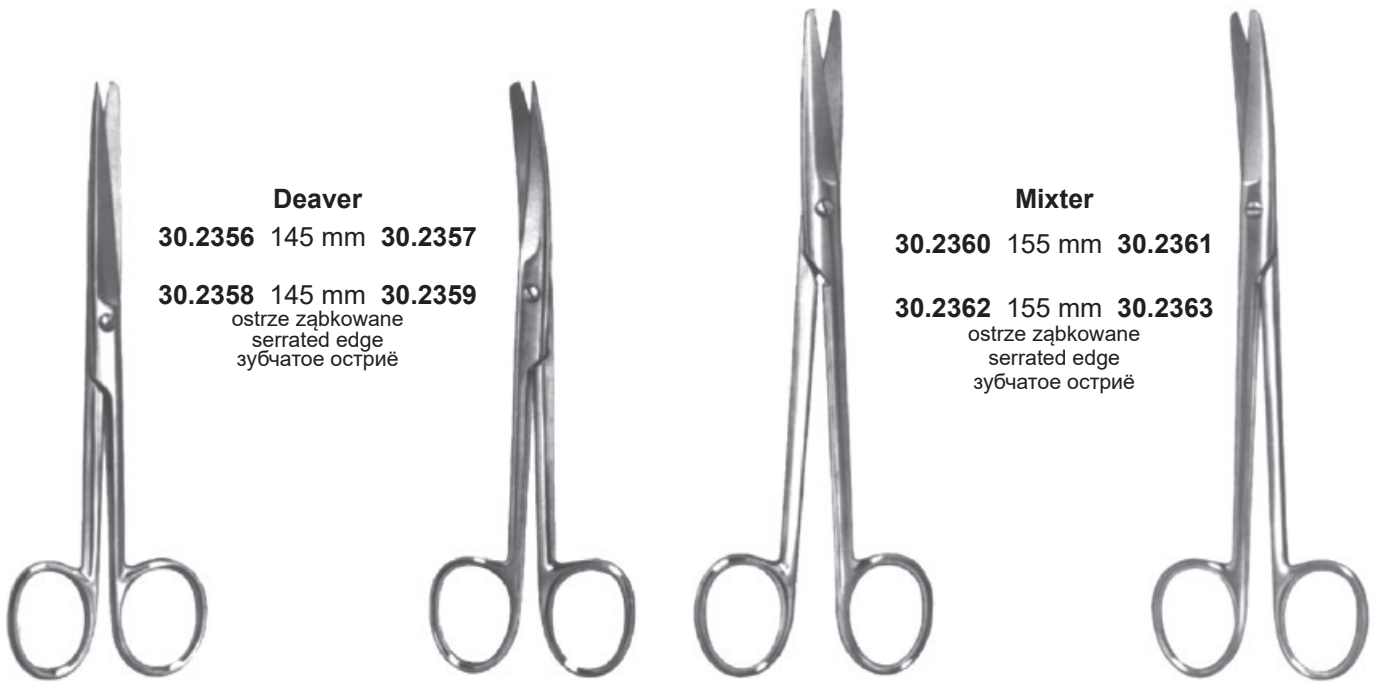

Deaver

30.2356 145 mm **30.2357**

30.2358 145 mm **30.2359**
ostrze ząbkowane
serrated edge
зубчатое остриё

Mixer

30.2360 155 mm **30.2361**

30.2362 155 mm **30.2363**
ostrze ząbkowane
serrated edge
зубчатое остриё

do nacięć • for incisions • для нарезки

brzuszne • abdominal • брюшные



Richter

30.2364 130 mm
30.2365 145 mm

30.2366 145 mm **30.2578**
30.2577 170 mm **30.2579**

Doyen

30.2367 160 mm **30.2369**
30.2368 175 mm **30.2370**

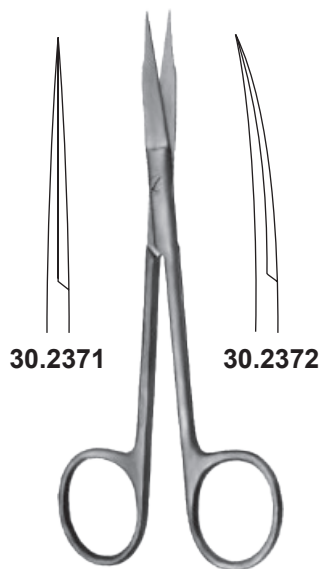

Goldmann-Fox

130 mm



Mayo-Lexer

30.2373.000 160 mm **30.2374.000**

wąskie • delicate • тонкие:

30.2373.100 **30.2374.100**



Baby-Lexer

30.2375 100 mm **30.2376**



Mayo-Noble

30.2378 170 mm **30.2380**



Mayo-Harrington

30.2382 230 mm **30.2381**
(proste) (odgięte)



Metzenbaum, Fino

30.2389 145 mm 30.2392
30.2390 150 mm 30.2393
30.2391 180 mm 30.2394



Metzenbaum-Lahey

30.2395 140 mm 30.2396

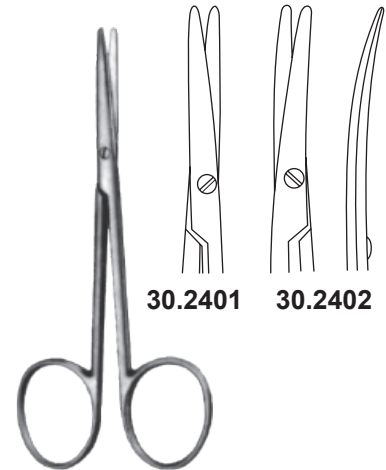

**Metzenbaum
(Strabismus)**
115 mm

30.2401

30.2402



Kelly

30.2403 160 mm 30.2405
30.2404 180 mm 30.2406



Joseph

30.2407 145 mm 30.2408



Kilner

30.2409 130 mm
30.2410 150 mm

operacyjne, ginekologiczne • operating, gynecological • операционные, гинекологические

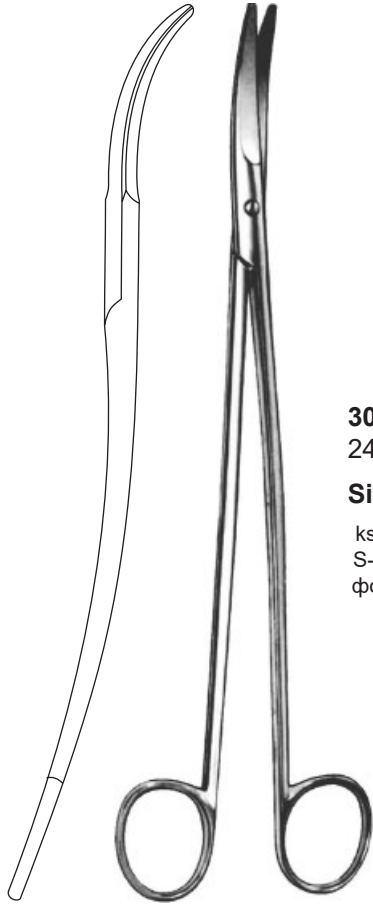

30.2397
240 mm
Siebold
kształt S
S-curved
форма S



30.2398 145 mm
30.2399 195 mm
30.2400 225 mm
Wertheim

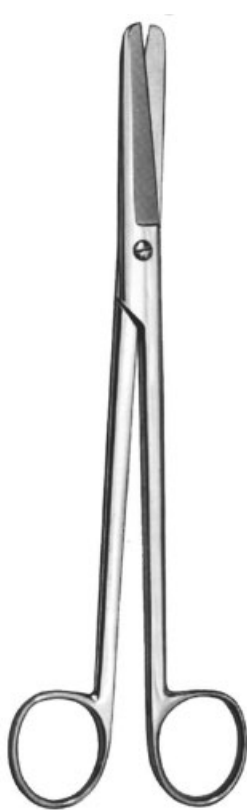

Sims



30.2411 200 mm
30.2412 230 mm



30.2413 200 mm
30.2414 230 mm

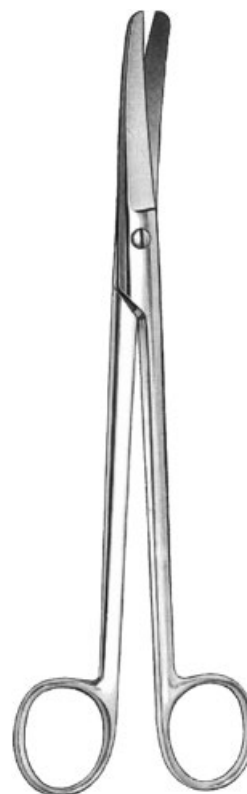

Sims



30.2415 200 mm
30.2416 230 mm



30.2417 200 mm
30.2418 230 mm

ginekologiczne, położnicze • umbilical and perineum • гинекологические, для пуповины



Dubois
30.2419 270 mm 30.2420



Schumacher
30.2422
155 mm



Busch
30.2423 130 mm
30.2424 160 mm



Mod. USA
30.2421
105 mm



Braun-Stadler
30.2425 145 mm
30.2426 220 mm



Waldmann
30.2531
180 mm

preparacyjne i naczyniowe • dissecting and vascular • анатомические и сосудистые



Tönnis

30.2427 180 mm **30.2428**



Adson-Tönnis

30.2429 175 mm

Reynolds

30.2430 160 mm



30.2431
115 mm



Dandy
30.2432
170 mm



Potts-Smith
30.2433
190 mm



Strully
30.2434
220 mm

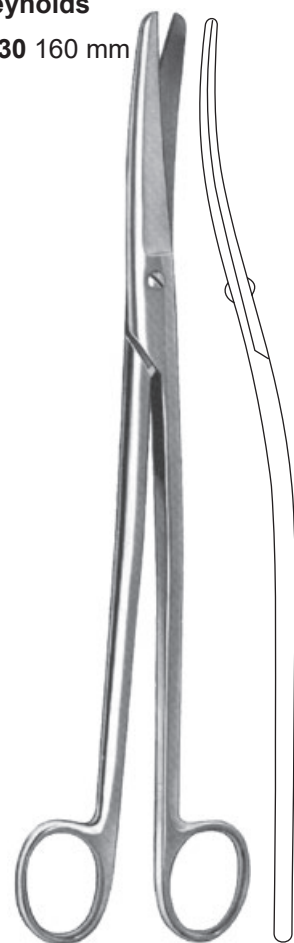

Satynsky
30.2435
245 mm

preparacyjne i naczyniowe • dissecting and vascular • анатомические и сосудистые

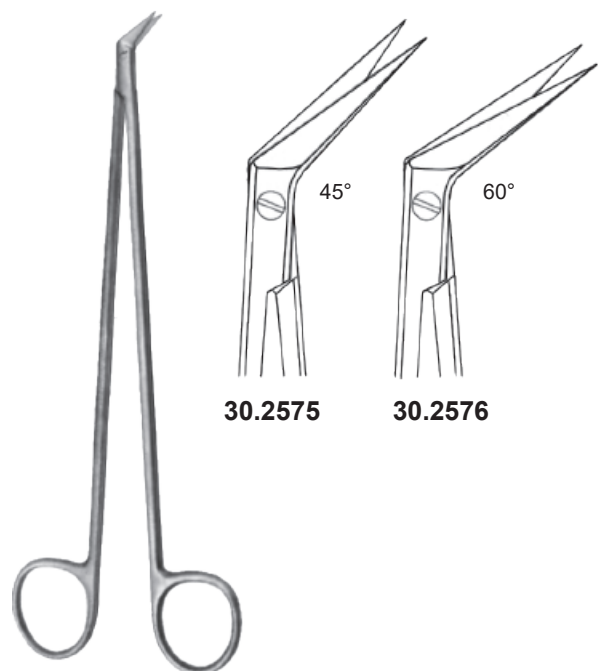
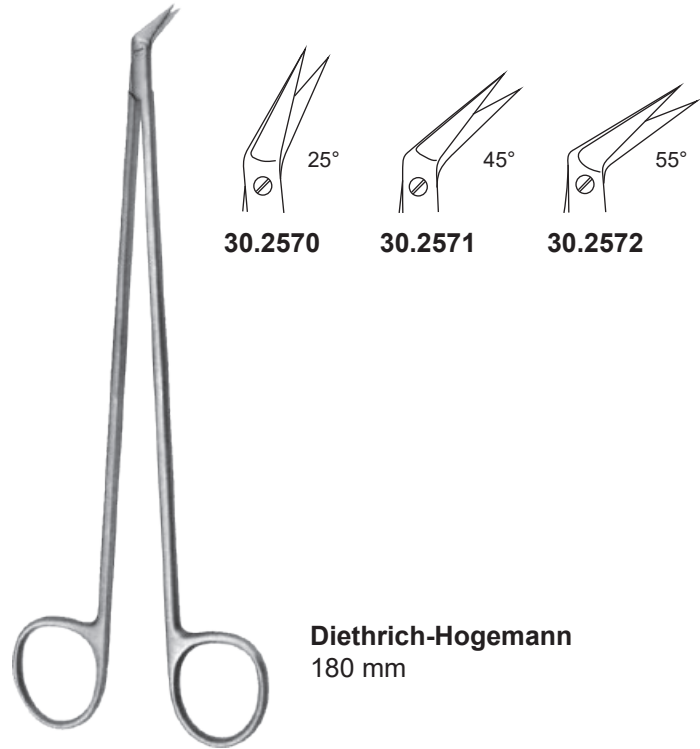
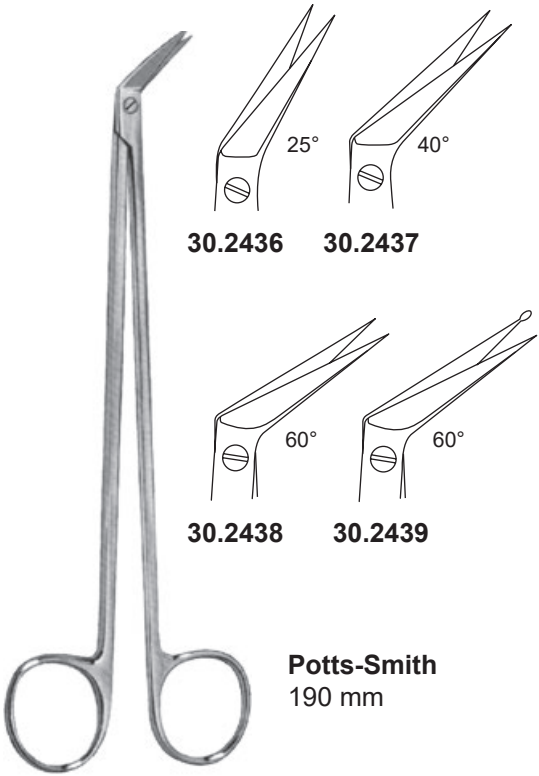



Schmieden
30.2441
170 mm
dura



30.2446
180 mm



30.2466	115 mm	30.2469
30.2467	130 mm	30.2470
30.2468	145 mm	30.2471



Dean
30.2443
170 mm



Good
30.2444
190 mm



Prince
30.2447
175 mm



Bottcher
30.2448
180 mm



Mc Indoe
30.2449
190 mm

do chrząstki
cartilage scissors
для хряща

do opatrunków, szwów, paznokci • ligature, nail scissors • для лигатуры, для ногтей



Ligaturschere

30.2450 115 mm **30.2451**

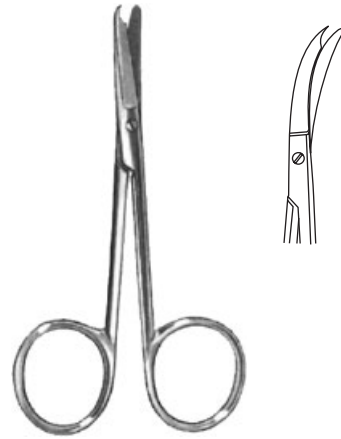

Spencer

30.2452 90 mm **30.2455**
30.2453 105 mm
30.2454 125 mm **30.2456**



Sistrunk

30.2457 130 mm **30.2458**



30.2459
150 mm



Littauer

30.2460
140 mm

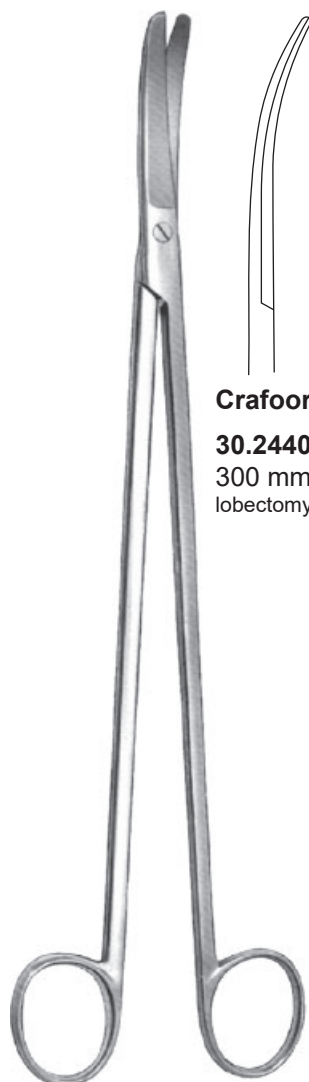

Crafoord
30.2440
300 mm
lobectomy

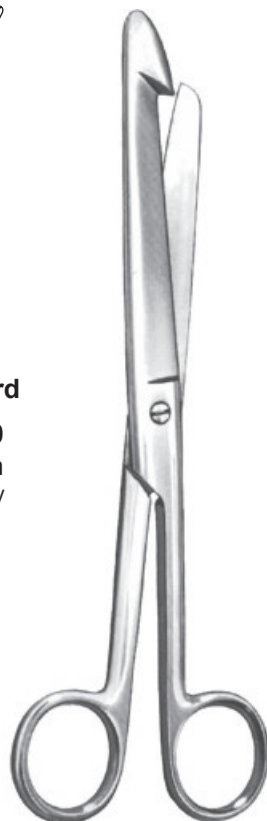

Darmschere
30.2461
210 mm



Darmschere
30.2462
210 mm



Heath
30.2464
150 mm



Universal
30.2465
120 mm

do opatrunków i do gipsu • bandage and plaster • перевязочные



Smith
30.2827 180 mm
30.2828 200 mm
30.2829 230 mm

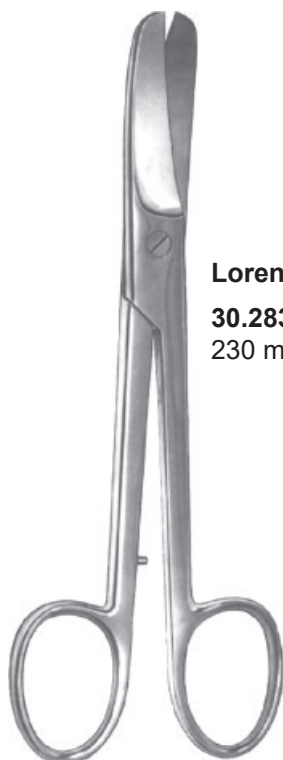

Lorenz
30.2830
230 mm



Knowles
145 mm
30.2831
proste
straight
прямые

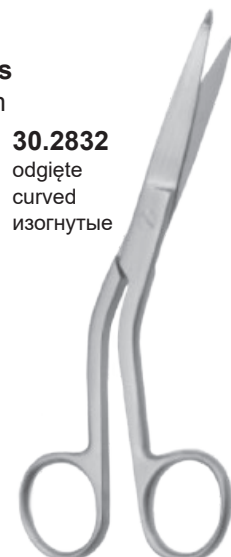

30.2832
odgięte
curved
изогнутые

do opatrunków i do gipsu • bandage and plaster • перевязочные



Esmarch

40.3284 200 mm
40.3285 230 mm



Seutin

40.3286
230 mm



Bruns

40.3287
235 mm



do gipsu syntetycznego
for syntetic plaster
для синтетического гипса

40.4139
180 mm



40.4140
180 mm



Lister

40.4141 90 mm
40.4142 110 mm
40.4143 140 mm
40.4144 180 mm
40.4145 200 mm

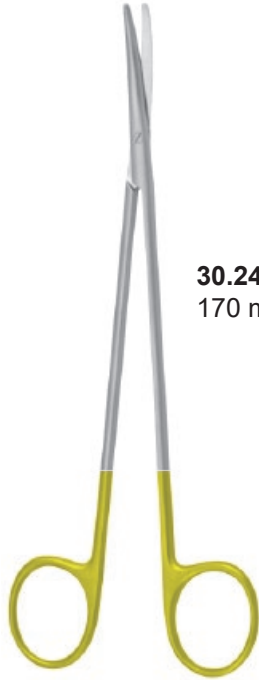

30.2472
170 mm

Tönnis-Adson



Standard

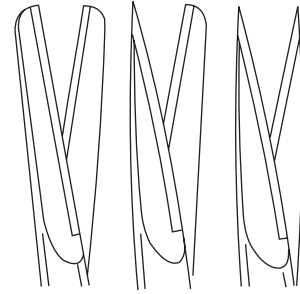

proste • straight • прямые

30.2473.000	30.2474.000	30.2475.000
	145 mm	
30.2473.165	30.2474.165	30.2475.165
	165 mm	

odgięte • curved • загнутые

30.2476.000	30.2477.000	30.2478.000
	145 mm	
30.2476.165	30.2477.165	30.2478.165
	165 mm	



Metzenbaum

30.2479	145 mm	30.2483
30.2480	180 mm	30.2484
30.2481	200 mm	30.2485
30.2482	230 mm	30.2486



Metzenbaum-Fino

30.2487	145 mm	30.2491
30.2488	180 mm	30.2492
30.2489	200 mm	30.2493
30.2490	230 mm	30.2494



Mayo-Style

30.2499	150 mm	30.2501
30.2500	170 mm	30.2502



Mayo

30.2495	145 mm	30.2497
30.2496	170 mm	30.2498



30.2504

Mayo-Lexer

30.2503 165 mm

Lister

30.2505.140	140 mm
30.2505.000	180 mm
30.2505.200	200 mm



30.2506

30.2507

30.2508

30.2509

Irisschere

115 mm



Strabismus (Metzenbaum)

115 mm

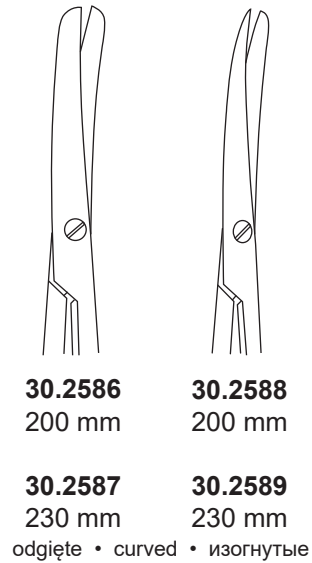
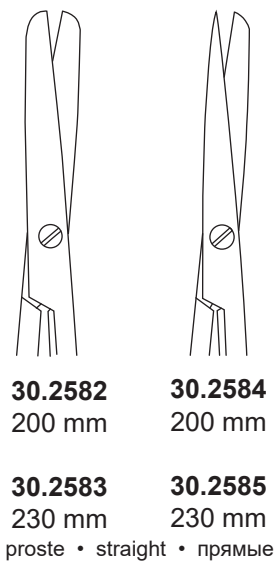
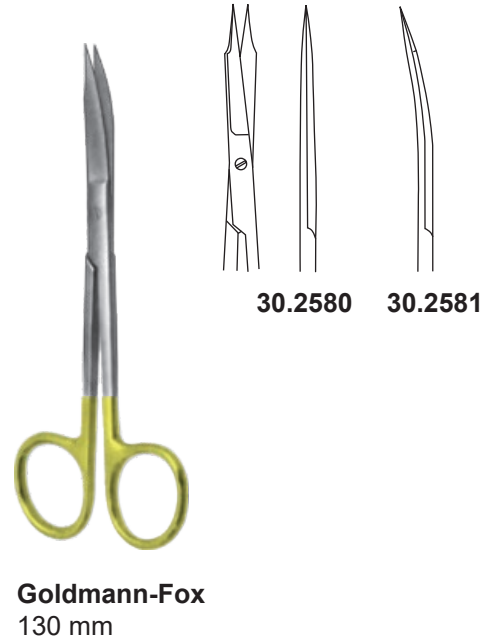
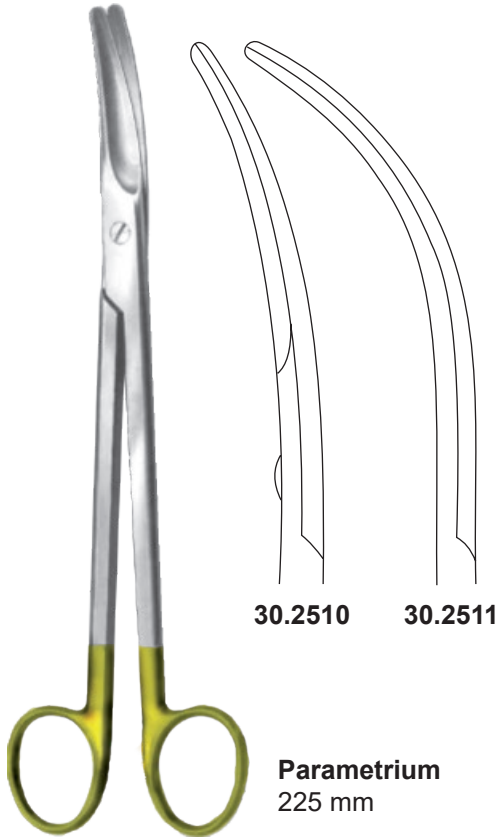

Sims



jedno ostrze tnące, drugie mikro-ząbkowane • with knife edge and micro-serrated edge • с одним лезвием режущим, другим микрозубчатым



Mayo

30.2532	145 mm	30.2534
30.2533	170 mm	30.2535
30.2533.230	230 mm	30.2535.230

Mayo-Stille

30.2536	150 mm	30.2538
30.2537	170 mm	30.2539

Mayo-Lexer

30.2540	160 mm	30.2541
----------------	--------	----------------

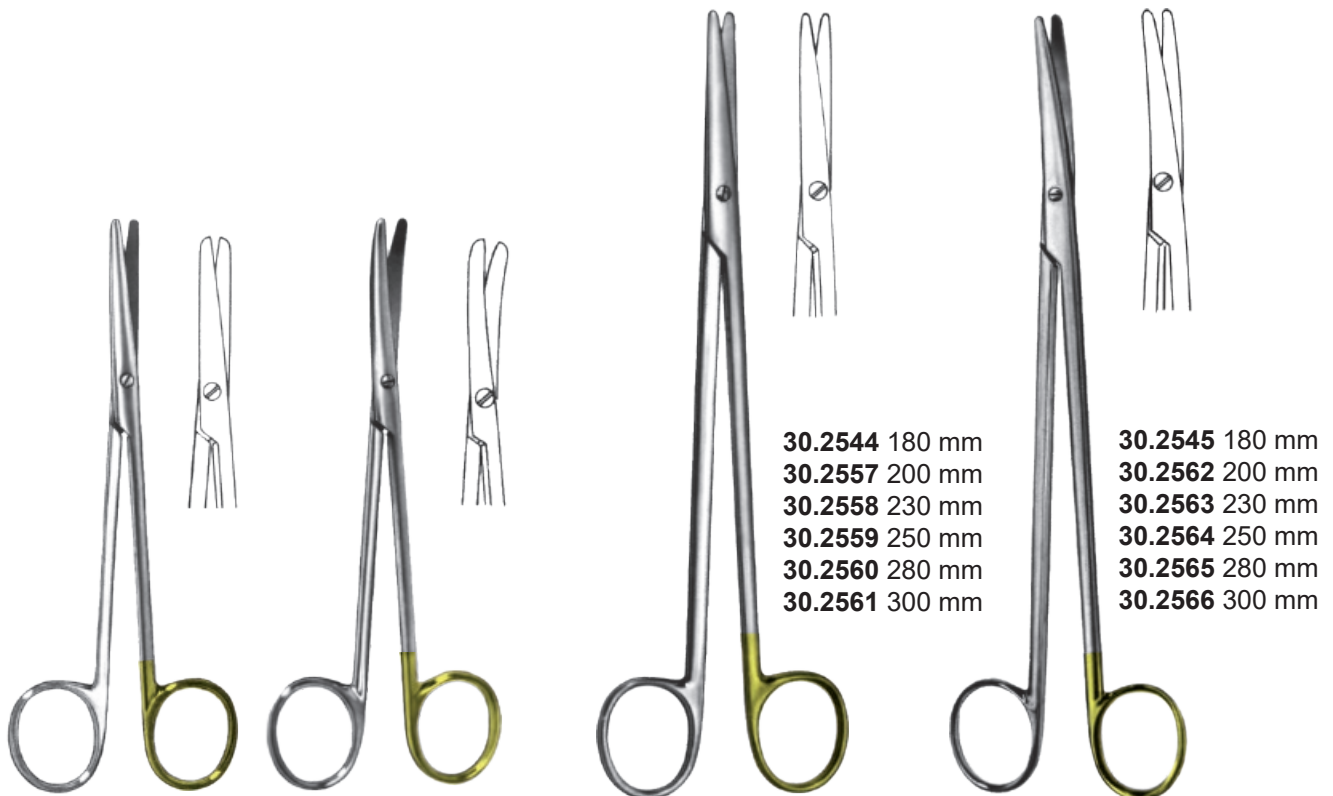

Metzenbaum

30.2542	145 mm	30.2543
----------------	--------	----------------

Metzenbaum

30.2544	180 mm	30.2545	180 mm
30.2557	200 mm	30.2562	200 mm
30.2558	230 mm	30.2563	230 mm
30.2559	250 mm	30.2564	250 mm
30.2560	280 mm	30.2565	280 mm
30.2561	300 mm	30.2566	300 mm

jedno ostrze tnące, drugie mikro-ząbkowane • with knife edge and micro-serrated edge • с одним лезвием режущим, другим микрозубчатым



Metzenbaum Fino
 30.2546 145 mm 30.2547

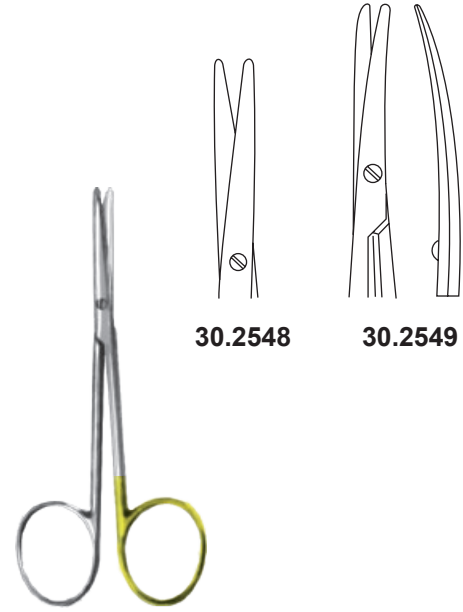

Metzenbaum Strabismus
 30.2548 30.2549
 115 mm



Lister
 30.2550 140 mm
 30.2551 180 mm
 30.2552 200 mm



Iris
 30.2553 30.2554
 115 mm

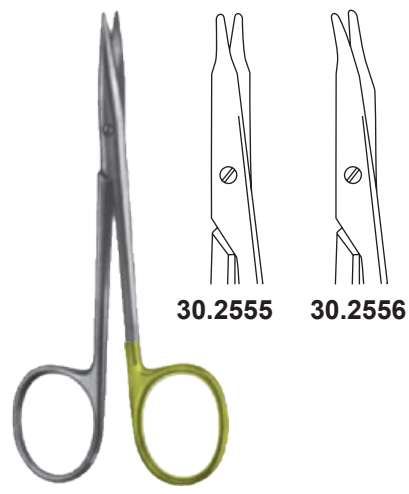

Stevens
 30.2555 30.2556
 110 mm



La Grange
 30.2567 105 mm
 30.2568 160 mm

anatomiczne • anatomical • анатомические

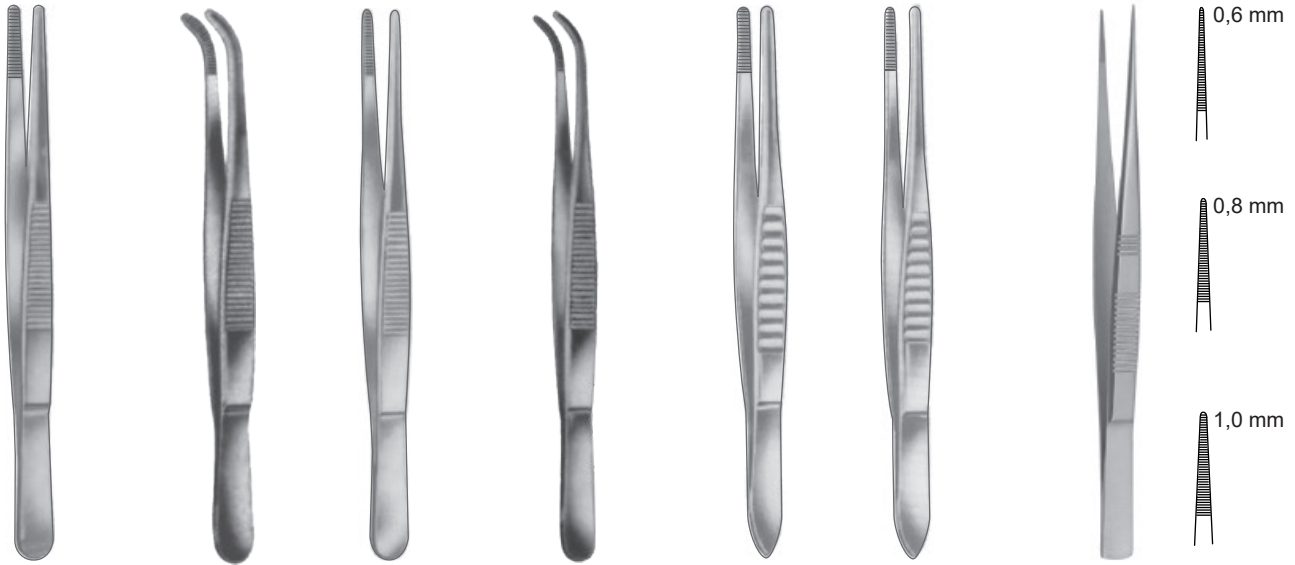

Standard

- 30.3300 105 mm
- 30.3301 115 mm
- 30.3302 130 mm
- 30.3303 145 mm
- 30.3304 160 mm
- 30.3305 180 mm
- 30.3306 200 mm
- 30.3307 250 mm
- 30.3308 300 mm

Standard

- 30.3318 115 mm
 - 30.3319 130 mm
 - 30.3320 145 mm
 - 30.3321 160 mm
 - 30.3322 180 mm
 - 30.3323 200 mm
 - 30.3324 250 mm
 - 30.3325 300 mm
- wąskie • narrow • узкие

Standard mod. USA

- 30.3334 120 mm
 - 30.3335 130 mm
 - 30.3336 145 mm
 - 30.3337 155 mm
 - 30.3338 180 mm
 - 30.3339 210 mm
 - 30.3340 250 mm
 - 30.3341 310 mm
- ▲ wąskie
narrow
узкие

- 30.3299.001 0,6 mm
 - 30.3299.002 0,8 mm
 - 30.3299.003 1,0 mm
- 155 mm

delikatne
slender
деликатные
▼

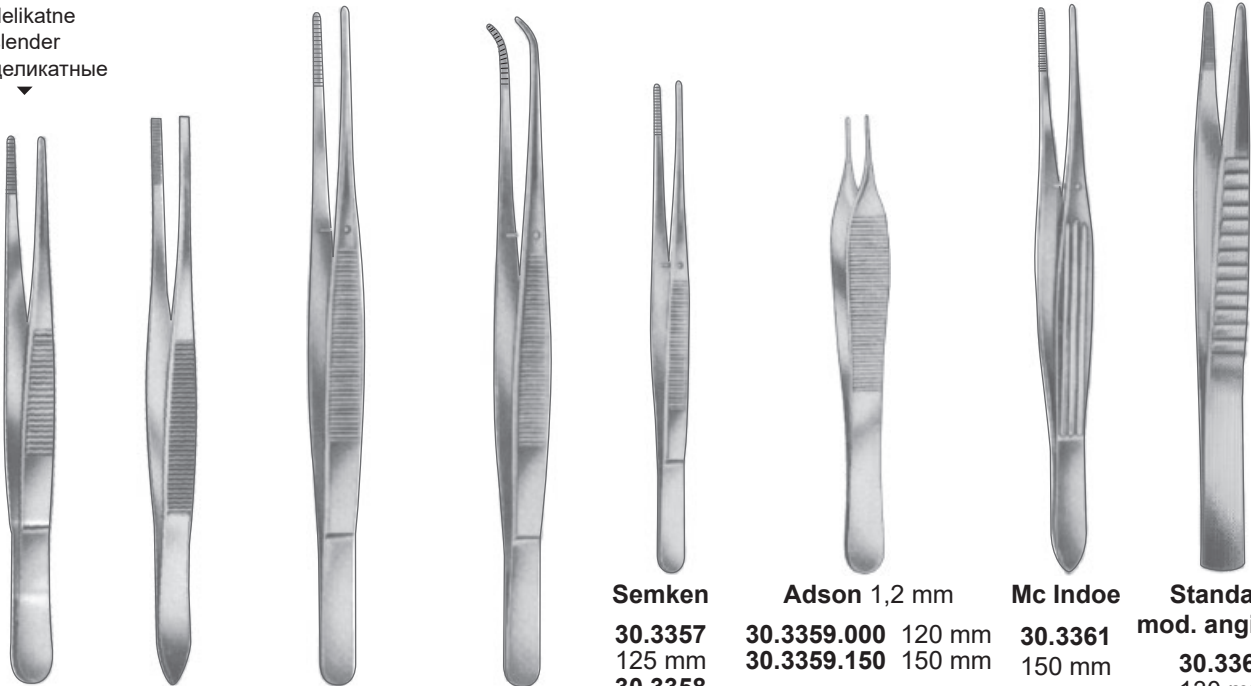

Standard

- 30.3346 130 mm
- 30.3347 150 mm
- 30.3348 170 mm

Potts-Smith

- 30.3351 180 mm
- 30.3352 210 mm
- 30.3353 250 mm
- 30.3354
- 30.3355
- 30.3356

Semken

- 30.3357 125 mm
- 30.3358 150 mm

Adson 1,2 mm

- 30.3359.000 120 mm
- 30.3359.150 150 mm
- Adson 0,8 mm mikro
- 30.3360.000 120 mm
- 30.3360.150 150 mm

Mc Indoe

- 30.3361 150 mm

Standard mod. angielski

- 30.3362 130 mm
- 30.3363 145 mm
- 30.3364 155 mm

anatomiczne • anatomical • анатомические



Taylor
30.3365 175 mm 30.3366



Taylor
30.3367 175 mm 30.3368



Gerald
30.3369 180 mm
prosta • straight • прямая

30.3370 180 mm
odgięta • curved • изогнутая



Waugh
30.3371 150 mm
30.3372 200 mm



Cushing
30.3373 175 mm 30.3374



30.3375 30.3376 30.3377
delikatne • slender • деликатные
105 mm



Brophy
30.3378 200 mm 30.3379





Standard		Standard		Standard		Standard mod. USA	
1:2	2:3	3:4	4:5	1:2		1:2	2:3
30.3380 105 mm		30.3397 130 mm	30.3400	30.3403 130 mm		30.3407 120 mm	30.3415
30.3381 115 mm	30.3389	30.3398 145 mm	30.3401	30.3404 145 mm		30.3408 130 mm	30.3416
30.3382 130 mm	30.3390	30.3399 160 mm	30.3402	30.3405 160 mm		30.3409 145 mm	30.3417
30.3383 145 mm	30.3391			30.3406 200 mm		30.3410 155 mm	30.3418
30.3384 160 mm	30.3392					30.3411 180 mm	30.3419
30.3385 180 mm	30.3393					30.3412 210 mm	30.3420
30.3386 200 mm	30.3394					30.3413 250 mm	30.3421
30.3387 250 mm	30.3395					30.3414 310 mm	30.3422
30.3388 300 mm	30.3396						

↑
wąska
narrow
узкие

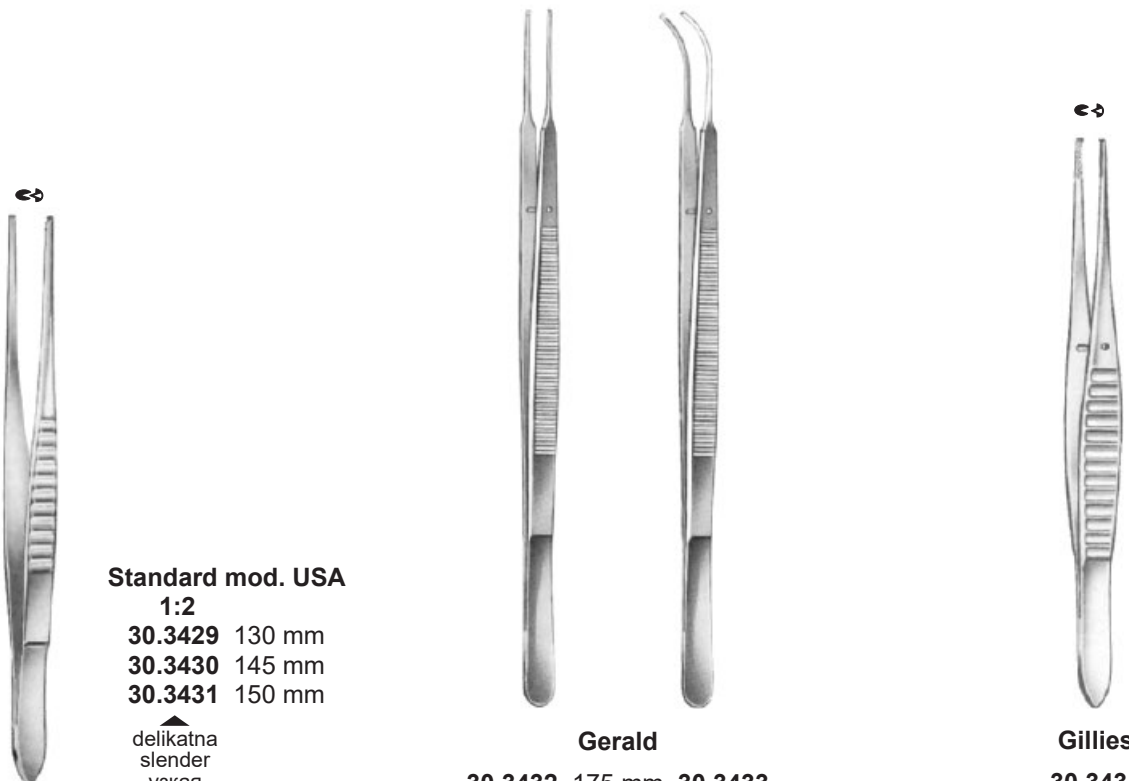

Standard mod. USA
1:2
30.3429 130 mm
30.3430 145 mm
30.3431 150 mm
↑
delikatna
slender
узкая

Gerald
30.3432 175 mm **30.3433**

Gillies
30.3434
150 mm



Semken

30.3435 125 mm
30.3436 150 mm



Adson

1,2 mm
30.3437 120 mm
30.3438 150 mm



Waugh

30.3441 150 mm
30.3442 200 mm



Adlerkreutz

2:3
30.3443 150 mm
30.3444 200 mm
30.3445 250 mm



Adson-Brown

30.3449.000 120 mm, 9X9
30.3449.007 120 mm, 7x7

9x9
7x7



Tayler

30.3450 175 mm 30.3451



Brophy

30.3452 200 mm 30.3453



Cushing

30.3454 175 mm 30.3455



Tayler

30.3456 175 mm 30.3457



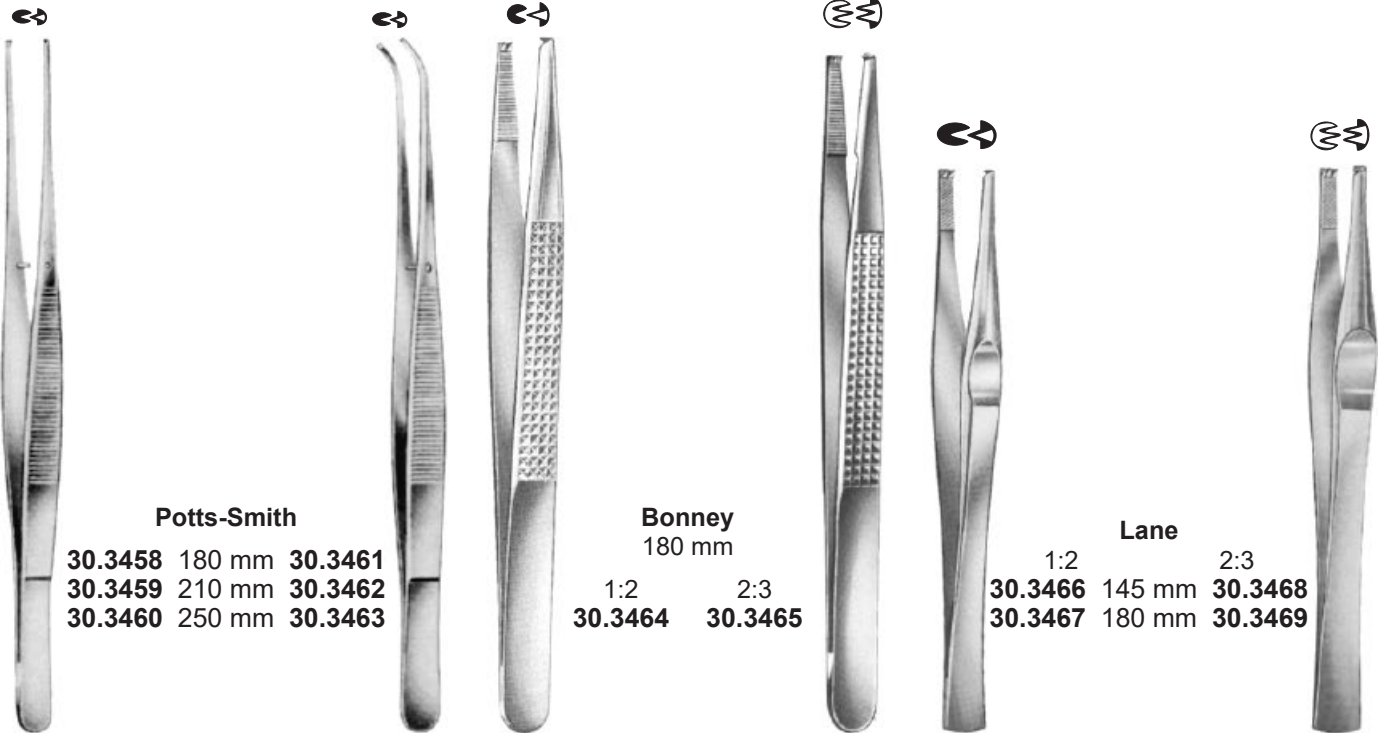

Potts-Smith
30.3458 180 mm 30.3461
30.3459 210 mm 30.3462
30.3460 250 mm 30.3463

Bonney
180 mm
1:2 2:3
30.3464 30.3465

Lane
1:2 2:3
30.3466 145 mm 30.3468
30.3467 180 mm 30.3469

plucne chwytające • lung grasping • для легких

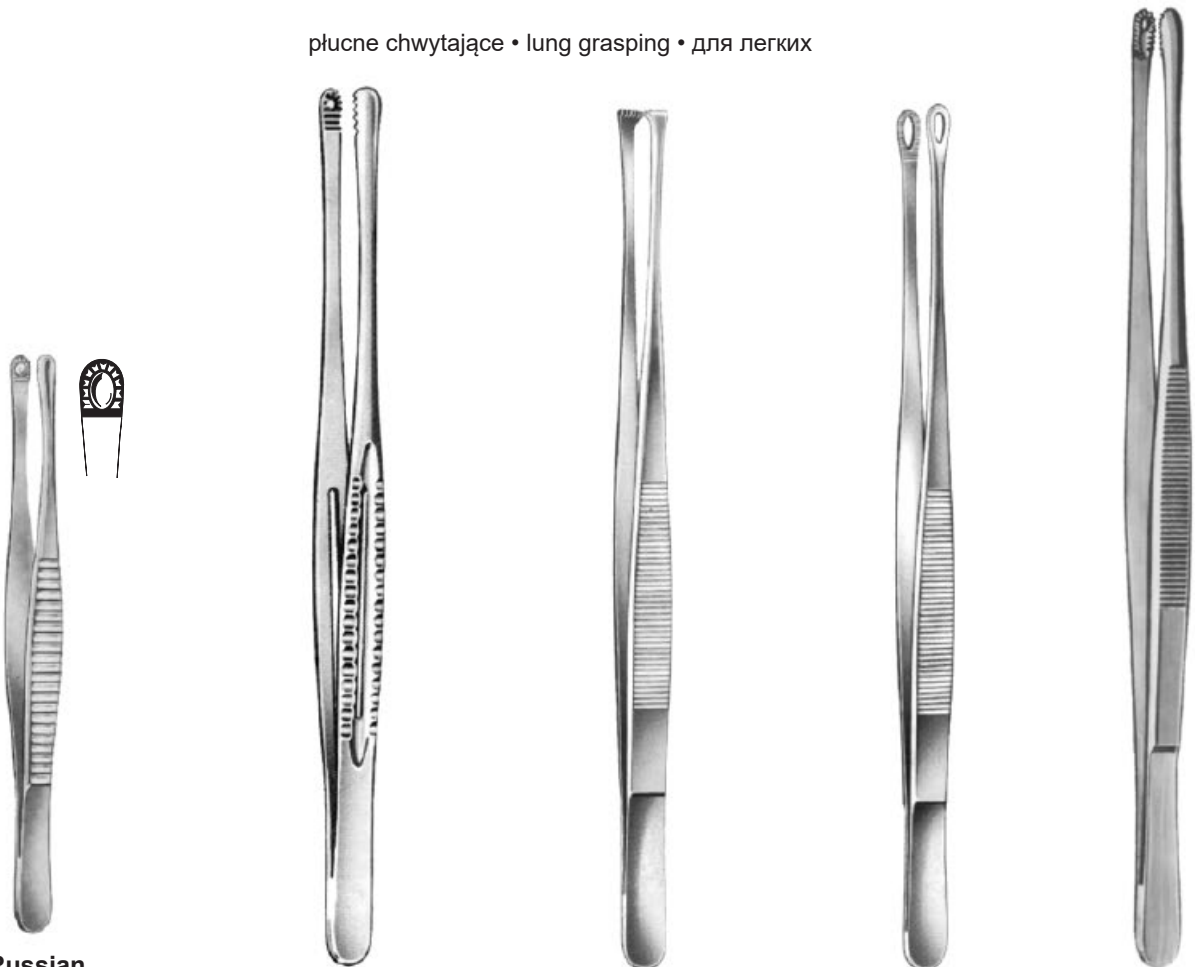

Russian
30.3470 150 mm
30.3471 200 mm
30.3472 250 mm

Mayo-Russian
30.3473
230 mm

Nelson
30.3474.180 180 mm
30.3474.000 230 mm

Singley-Tut
30.3475
230 mm

Davis
30.3476
250 mm

delikatne • slender • деликатные



30.3480
105 mm



30.3481
105 mm



30.3482
105 mm

atraumatyczne • atraumatic • хирургические



De Baky



1,5 mm

30.3483
30.3484
30.3485
30.3486



2,0 mm

30.3487
30.3488
30.3489
30.3490



2,7 mm

30.3491
30.3492
30.3493
30.3494



3,5 mm

30.3495
30.3496
30.3497
30.3498

160 mm
200 mm
240 mm
300 mm



De Baky

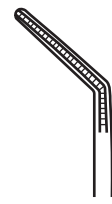

2,0 mm

30.3499
30.3500
30.3501
30.3502

pincety ENT • ENT forceps • ENT пинцеты



Lucae 1 x 2
30.3504
140 mm



Lucae
30.3505
140 mm



Troeltsch (Wilde)
30.3524 110 mm
30.3525 120 mm
30.3526 150 mm
30.3527 180 mm



Troeltsch (Wilde)
1 x 2
30.3528 120 mm
30.3529 150 mm



Jansen
30.3530 160 mm
30.3531 180 mm
Grünwald-Jansen
30.3532 200 mm



Cottle
30.3533
140 mm

do guzków • tumor forceps • хирургические



Yasargil
220 mm



30.3583
3 mm



30.3584
5 mm

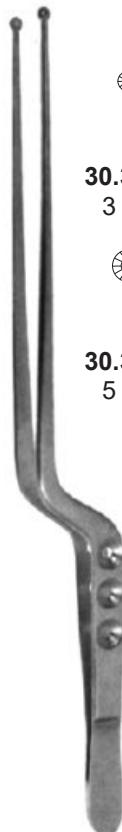

Yasargil
220 mm



30.3585
3 mm



30.3586
5 mm



Yasargil
220 mm



30.3587
3 mm



30.3588
5 mm



30.3514



30.3517



30.3518



30.3519



30.3520



30.3521



30.3522



30.3523



gładka
smooth
гладкая

30.3534	80 mm	30.3539
30.3535	90 mm	30.3540
30.3536	105 mm	30.3541
30.3537	115 mm	30.3542
30.3538	125 mm	30.3543



ząbkowana
serrated
зубчатая

30.3544	80 mm	30.3549
30.3545	90 mm	30.3550
30.3546	105 mm	30.3551
30.3547	115 mm	30.3552
30.3548	125 mm	30.3553



gładka
smooth
гладкая

30.3554	80 mm	30.3559
30.3555	90 mm	30.3560
30.3556	105 mm	30.3561
30.3557	115 mm	30.3562
30.3558	125 mm	30.3563



ząbkowana
serrated
зубчатая

30.3564	80 mm	30.3569
30.3565	90 mm	30.3570
30.3566	105 mm	30.3571
30.3567	115 mm	30.3572
30.3568	125 mm	30.3573



Feilchenfeld

30.3574	75 mm
30.3575	90 mm
30.3576	115 mm



Hunter

30.3577	105 mm
----------------	--------



Hunter

30.3578	105 mm
----------------	--------



Walter-Carmalt

30.3579	105 mm
----------------	--------



Walter-Carmalt

30.3580	105 mm
----------------	--------

laboratoryjne • cover glass forceps • лабораторные



Kuehne
30.3594
105 mm



Kuehne
30.3595
105 mm



Kuehne
30.3596
105 mm



30.3597
105 mm

inne • others • другие

mikroskopowe
microscope forceps
микроскопические



Beer
30.3589 80 mm
30.3590 90 mm



Littauer
30.3591
85 mm



Douglas
30.3592
90 mm



Douglas
30.3593
90 mm



30.3581
tępa
blunt
тупая
100 mm



30.3582
ostra
sharp
острая
100 mm

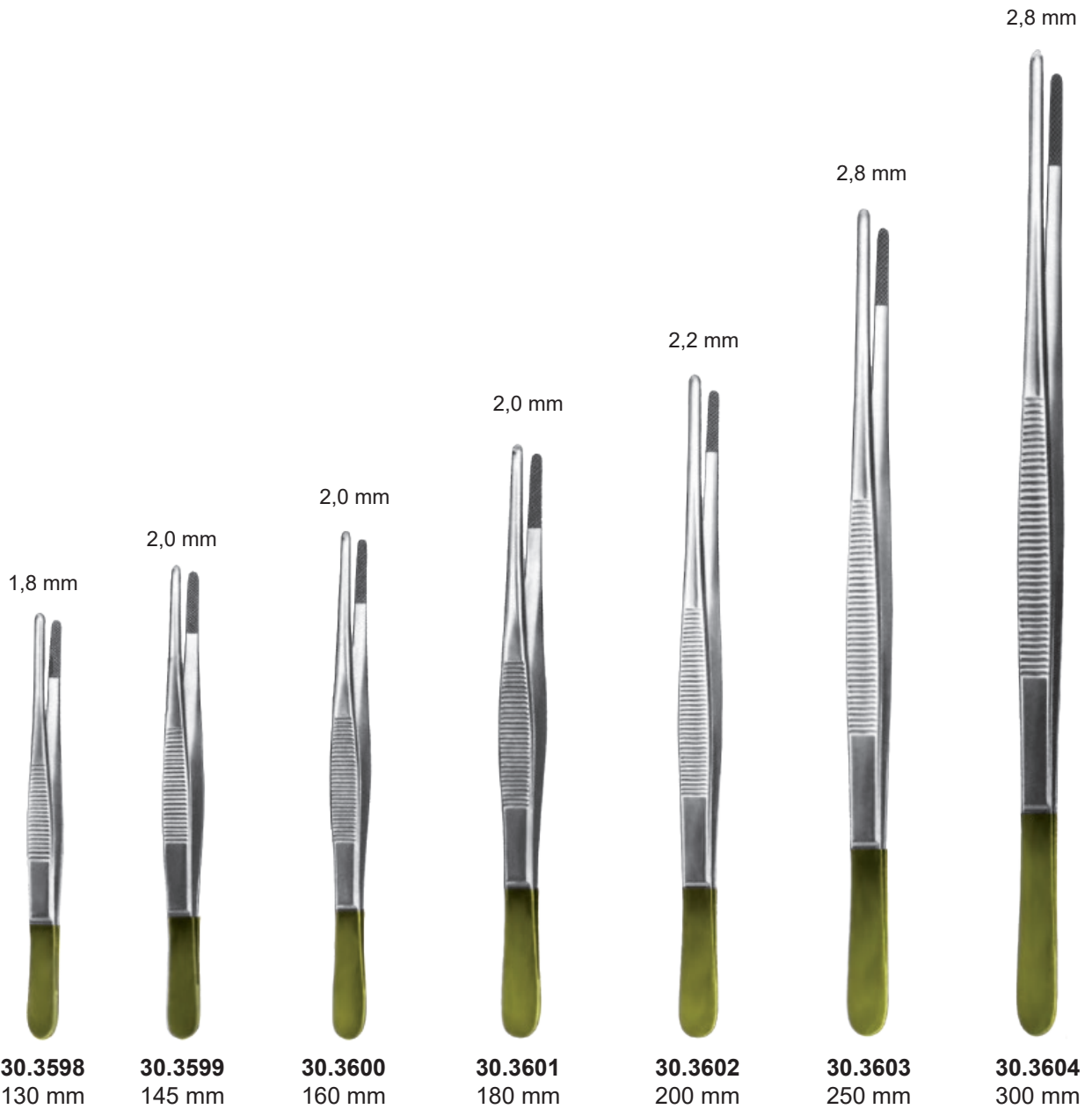

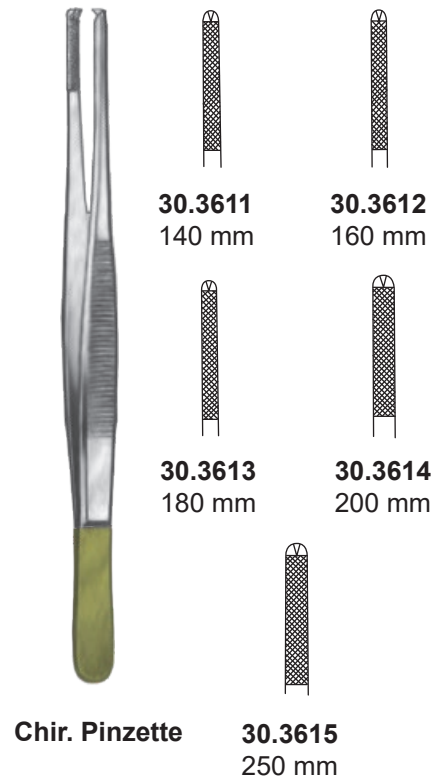
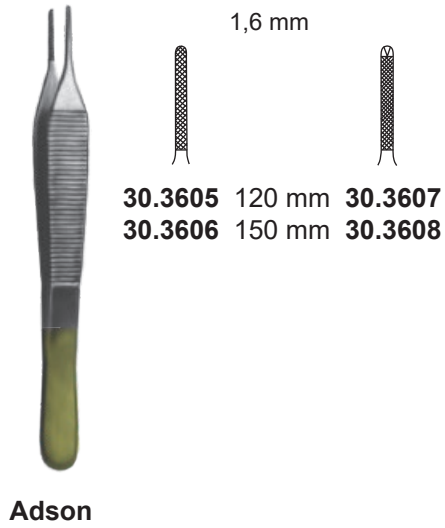



Halsted-Mosquito

30.0080 125 mm 30.0083
30.0081 140 mm 30.0084
30.0082 125 mm 30.0085
mikro • micro • микро

Halsted-Mosquito

30.0086 125 mm 30.0089
30.0087 140 mm 30.0090
30.0088 125 mm 30.0091
mikro • micro • микро

Halsted-Mosquito

30.0083.100
125mm



Hartmann

30.0092 100 mm 30.0094
mikro • micro • микро
30.0093 100 mm 30.0095

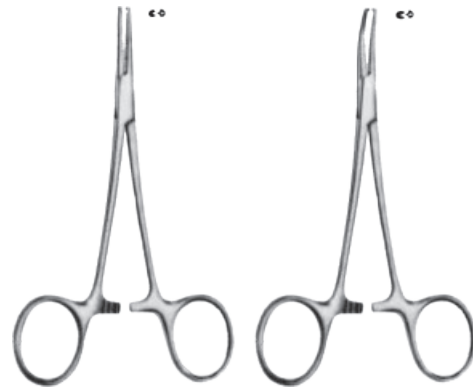

Hartmann

30.0092.100 100mm 30.0094.100
mikro • micro • микро

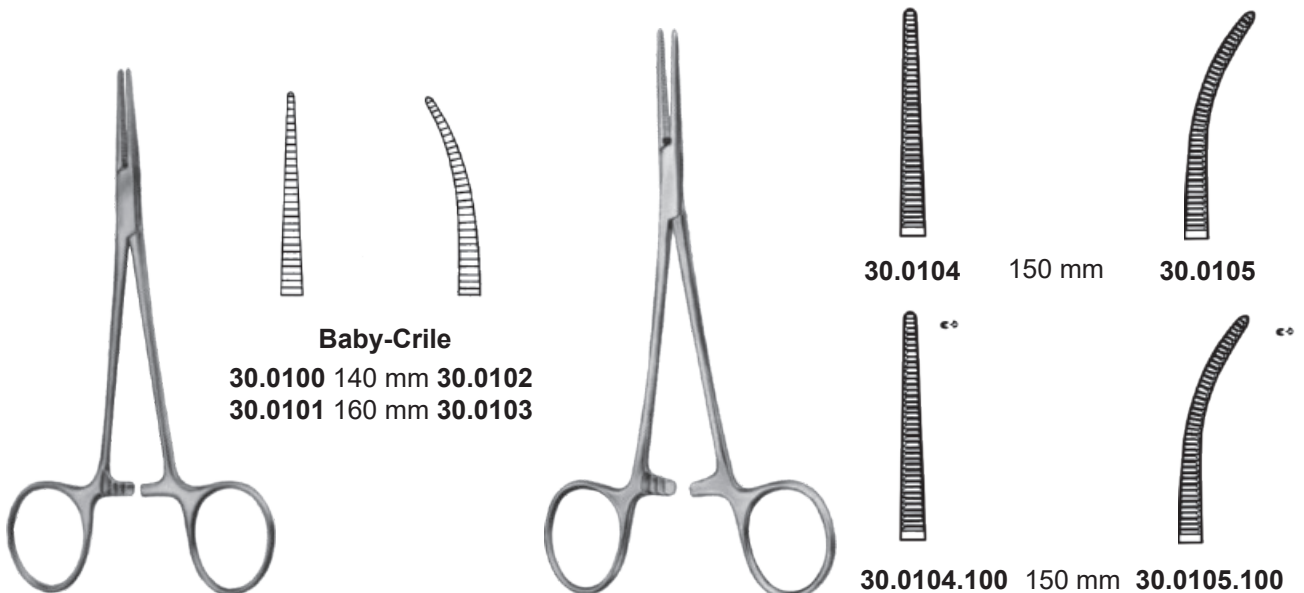

Baby-Crile

30.0100 140 mm 30.0102
30.0101 160 mm 30.0103

Leriche

30.0104 150 mm 30.0105
30.0104.100 150 mm 30.0105.100

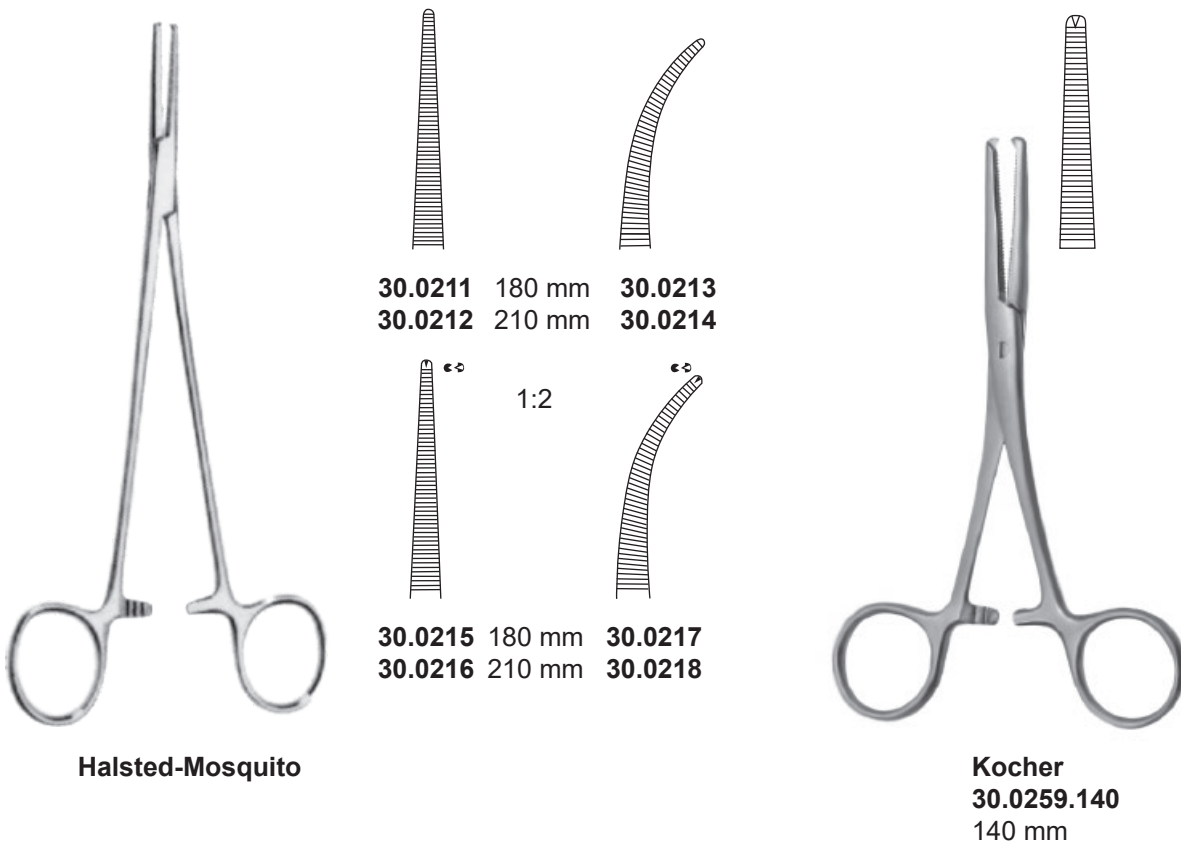
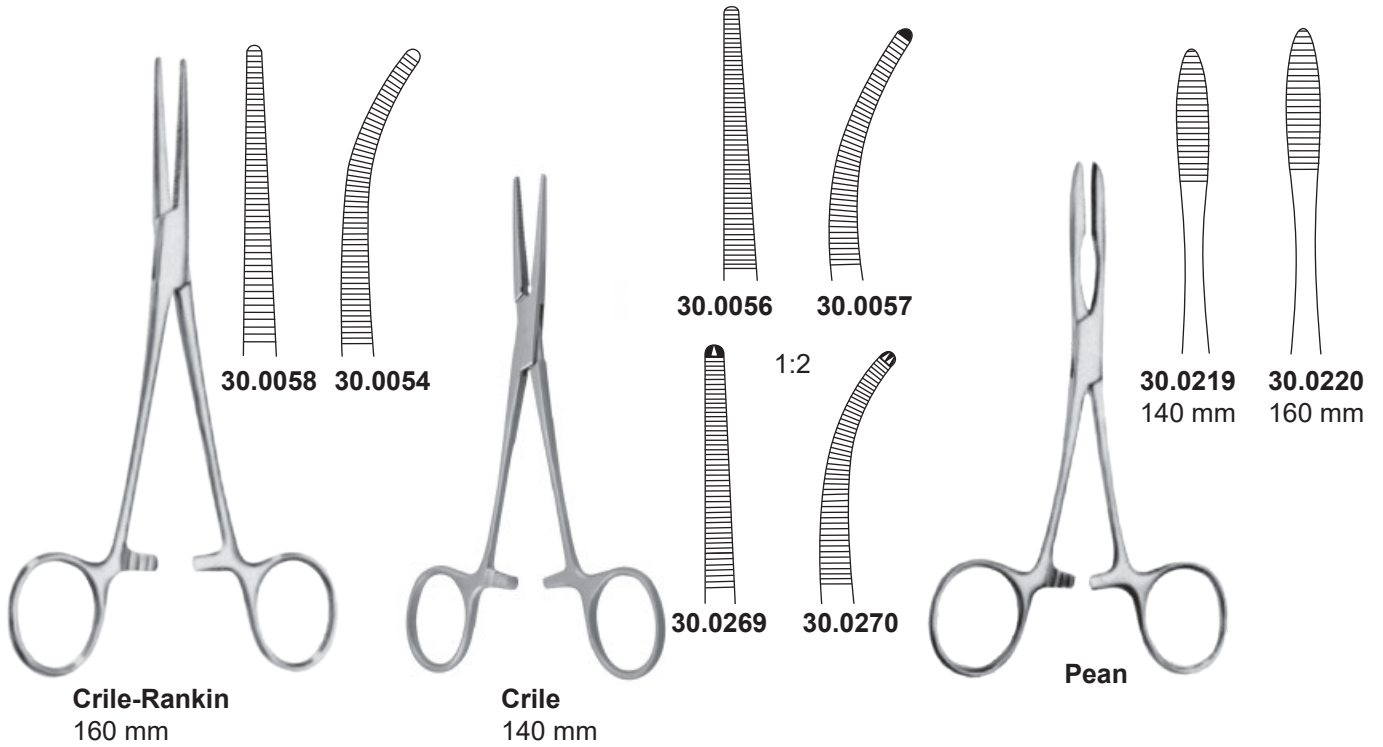



30.0221.130 130 mm
30.0221.000 140 mm
proste
straight
прямой

30.0222.130 130 mm
30.0222.000 140 mm
odgięte
curved
изогнутый

Pean
delikatne • fine • тонкие

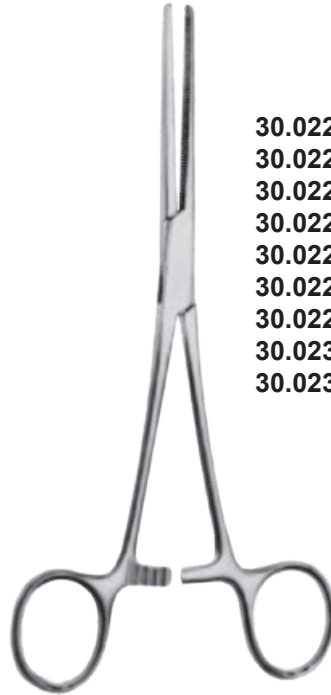

30.0223 130 mm **30.0232**
30.0224 140 mm **30.0233**
30.0225 160 mm **30.0234**
30.0226 180 mm **30.0235**
30.0227 200 mm **30.0236**
30.0228 220 mm **30.0237**
30.0229 240 mm **30.0238**
30.0230 260 mm **30.0239**
30.0231 300 mm **30.0240**

Pean (Rochester)

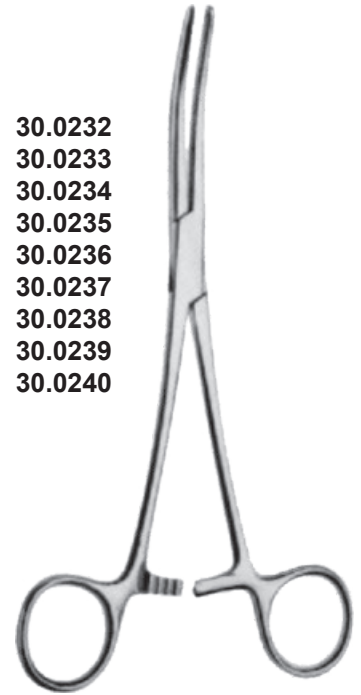

Pean (Rochester)

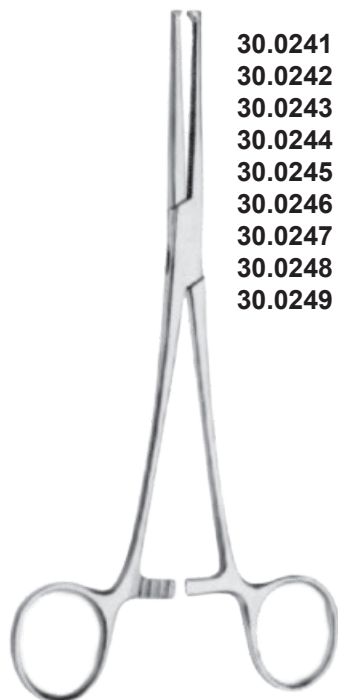

30.0241 130 mm **30.0250**
30.0242 140 mm **30.0251**
30.0243 160 mm **30.0252**
30.0244 180 mm **30.0253**
30.0245 200 mm **30.0254**
30.0246 220 mm **30.0255**
30.0247 240 mm **30.0256**
30.0248 260 mm **30.0257**
30.0249 300 mm **30.0258**

Kocher (Ochsner)

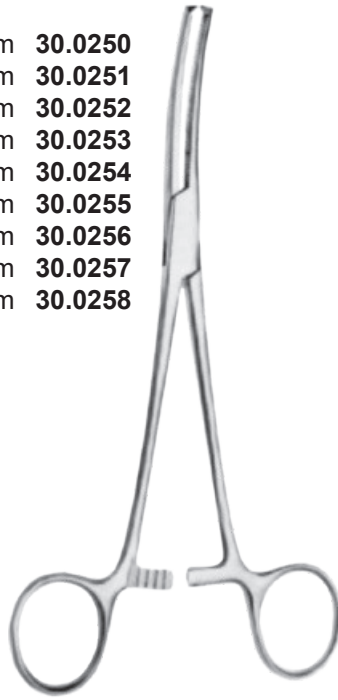

Kocher (Ochsner)



Kocher 140 mm
delikatne • slender • тонкие

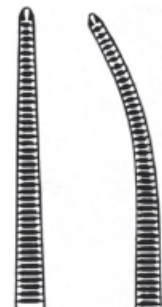

30.0259.000 **30.0260.000**
140 mm
30.0259.160 **30.0260.160**
160 mm



Rochester-Carmalt

30.0261 160 mm 30.0263
30.0262 200 mm 30.0264



Kelly
140 mm

30.0265

30.0266

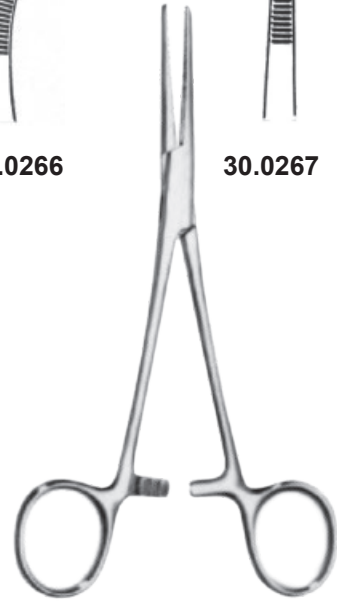

Kelly-Rankin
160 mm

30.0267

30.0268



Providence Hospital
140 mm

30.0271

30.0272



Lovlace
30.0273
155 mm

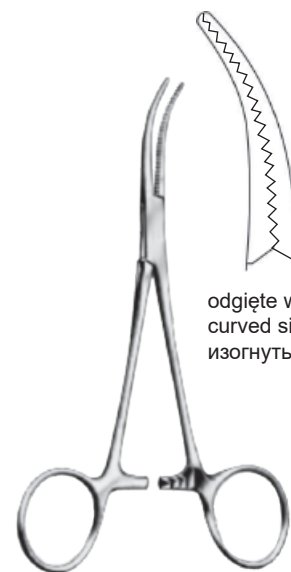

Dandy
30.0274
140 mm

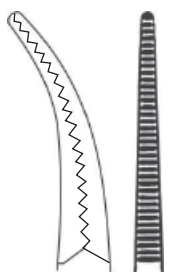

odgięte w bok
curved sideways
изогнутые на сторону



Adson
185 mm

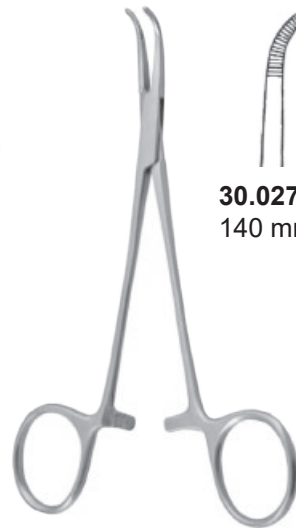
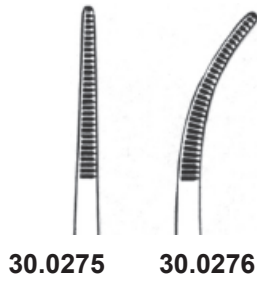

Baby-Adson

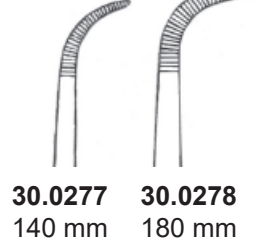

Pennington
30.0279 155 mm
30.2130 200 mm



Spencer-Wells

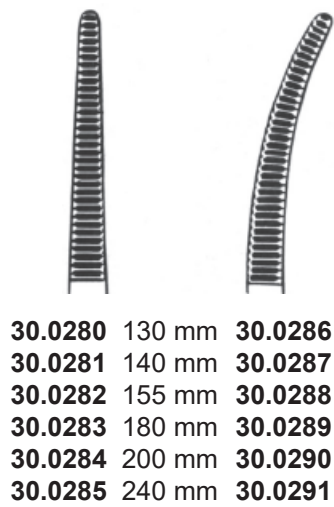

30.0280	130 mm	30.0286
30.0281	140 mm	30.0287
30.0282	155 mm	30.0288
30.0283	180 mm	30.0289
30.0284	200 mm	30.0290
30.0285	240 mm	30.0291



Heiss 200 mm

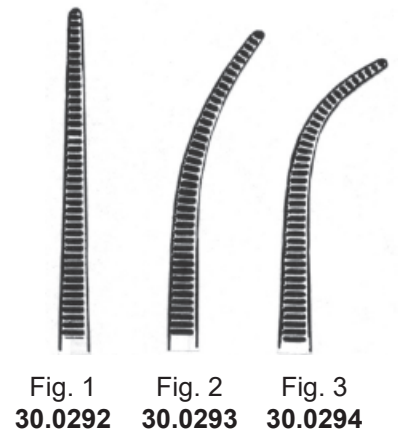

Fig. 1	Fig. 2	Fig. 3
30.0292	30.0293	30.0294



Roberts
220 mm



30.1900



30.1901



Zenker
295 mm

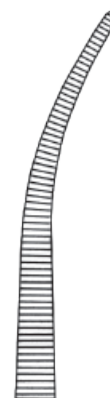

30.1902

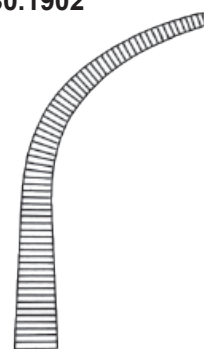

30.1903

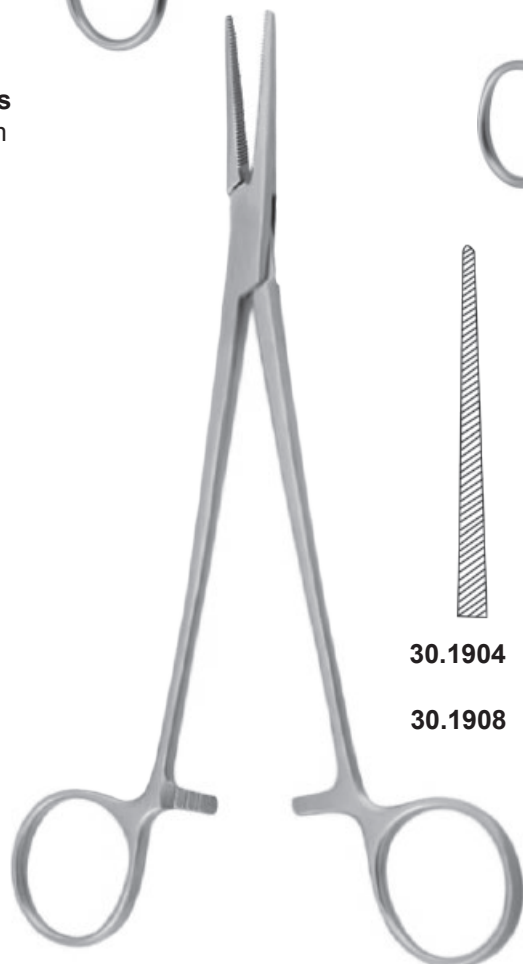

Bengolea



30.1904



30.1905



30.1906



30.1907

1:2

200 mm

30.1908

30.1909

30.1910

30.1911

260 mm



Mini-Gemini

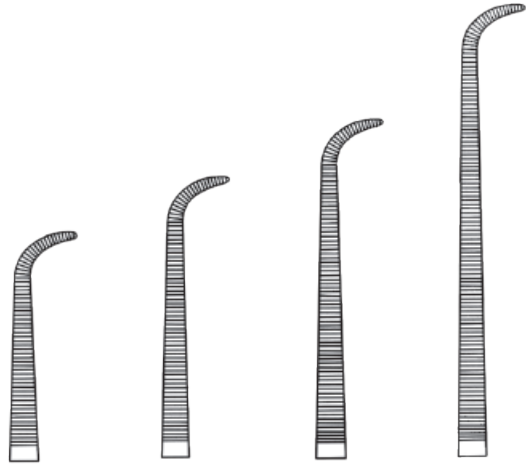

- 30.1912**
180 mm
- 30.1913**
220 mm
- 30.1914**
250 mm
- 30.1915**
280 mm



Gemini

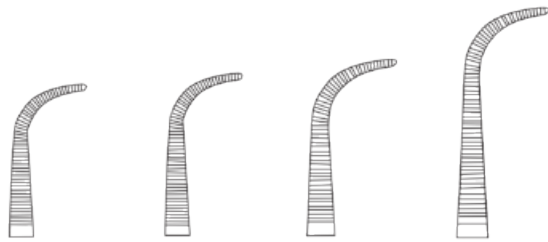

- 30.1916**
130 mm
- 30.1917**
140 mm
- 30.1918**
160 mm
- 30.1919**
180 mm

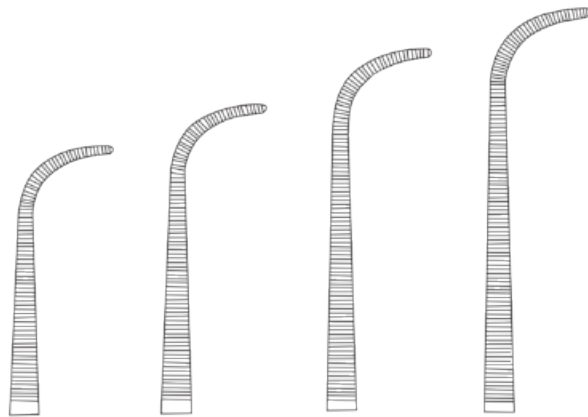

- 30.1920**
200 mm
- 30.1921**
230 mm
- 30.1922**
250 mm
- 30.1923**
280 mm



Kantrowitz

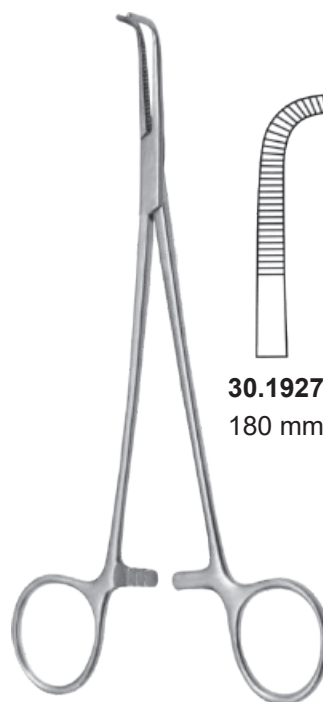
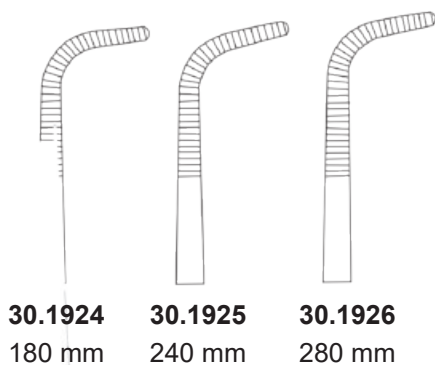

Meekers

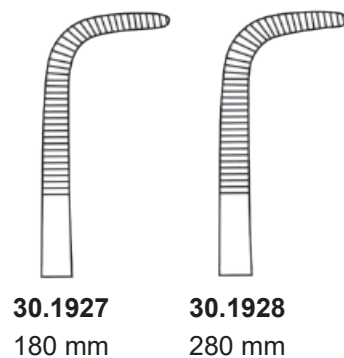

Overholt

delikatne • slender • тонкие

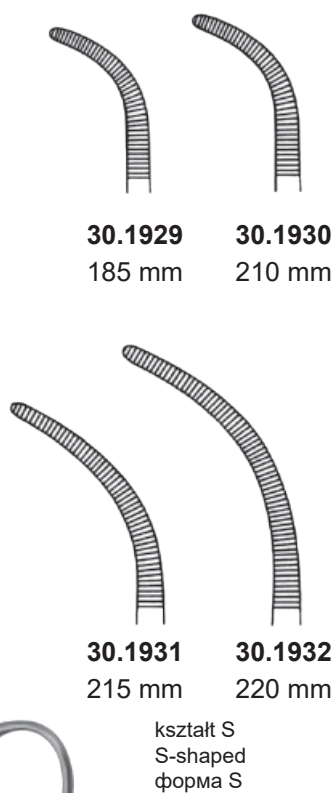

Stille

30.1933 240 mm



Green

30.1934 160 mm



**Overholt-
Geissendoerfer**



Fig. 1
30.0295
195 mm

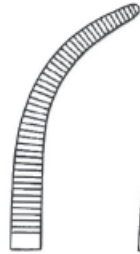

Fig. 2
30.0296
210 mm



Fig. 3
30.0297
220 mm

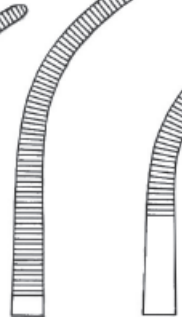

Fig. 4
30.0298
225 mm

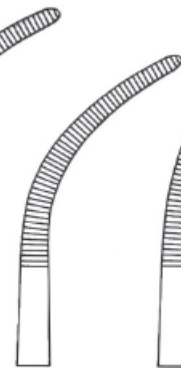

Fig. 5
30.0299
215 mm

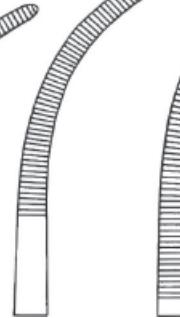

Fig. 6
30.2000
225 mm

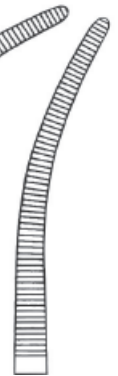

Fig. 7
30.2001
225 mm

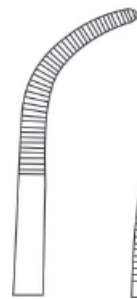

Fig. 1
30.2002
260 mm



Fig. 2
30.2003
270 mm



Fig. 3
30.2004
275 mm

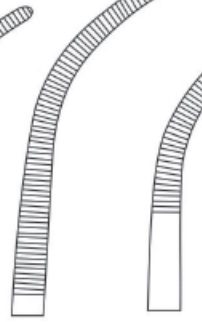

Fig. 4
30.2005
275 mm

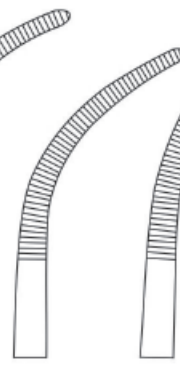

Fig. 5
30.2006
275 mm

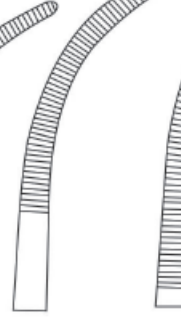

Fig. 6
30.2007
280 mm

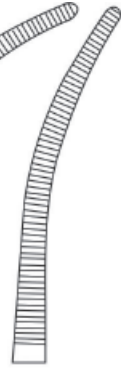

Fig. 7
30.2008
275 mm



30.2009

30.2010

30.2011

30.2012

Rumel
230 mm

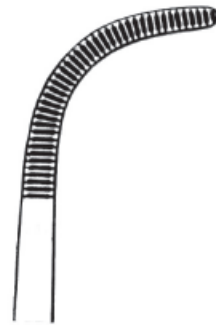

**30.2013
Crafoord**
240 mm





Mixer-Baby
30.2014 140 mm



30.2015 155 mm
30.2016 190 mm

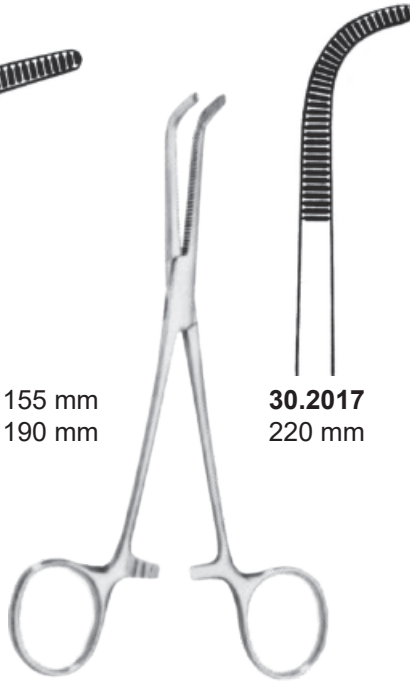

30.2017
220 mm

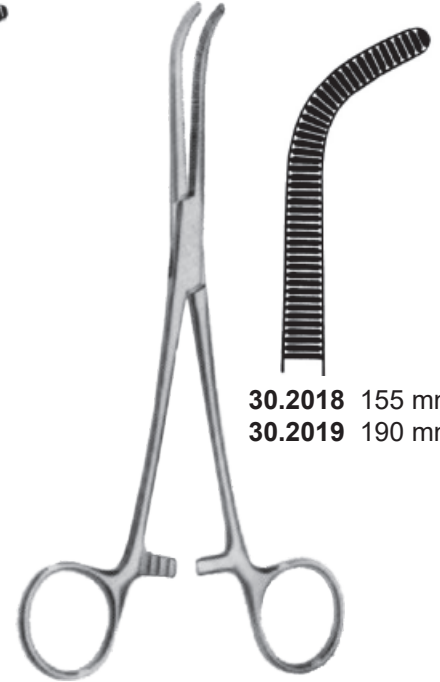

30.2018 155 mm
30.2019 190 mm

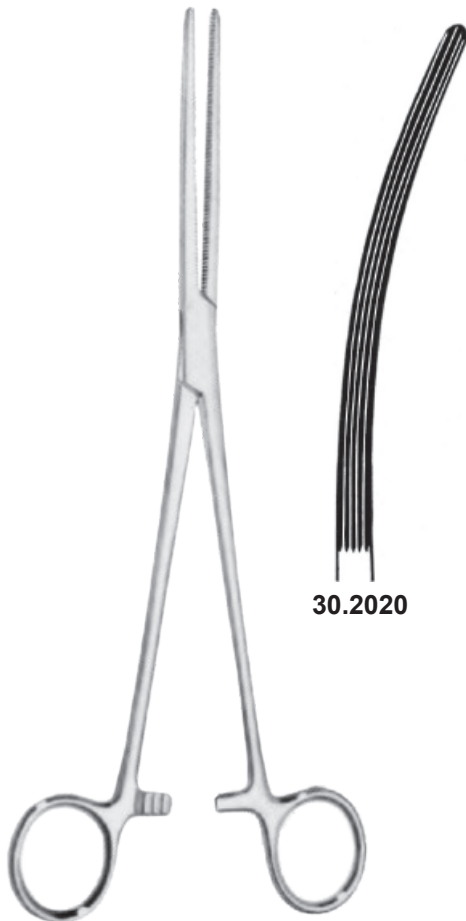

Crafoord-Sellers 240 mm

30.2020

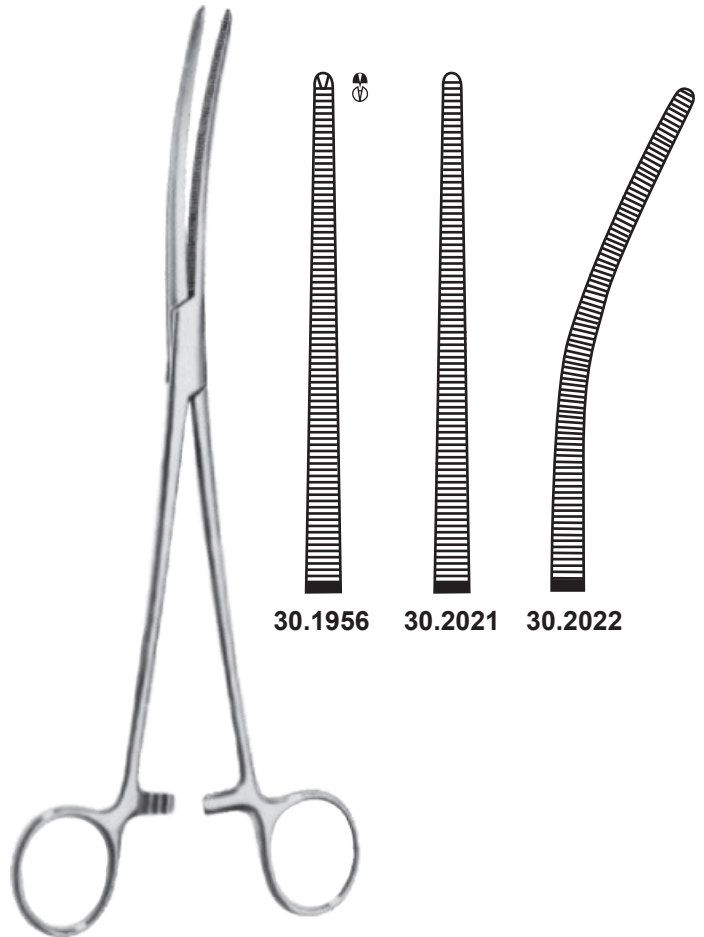

Sarot 240 mm

30.1956

30.2021

30.2022



30.2024

30.2023

Negus
190 mm



Johns Hopkins
30.2025
200 mm



Lower
30.2026
180 mm

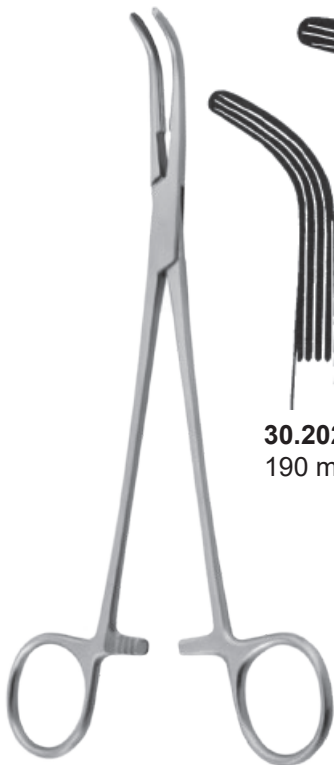

30.2027
190 mm

30.2028
230 mm

Lahey



30.2029
220 mm

30.2030
250 mm

30.2031
280 mm

Mixer



30.2032 220 mm
30.2033 230 mm

Gray



30.2036 **30.2037**
200 mm

Faure

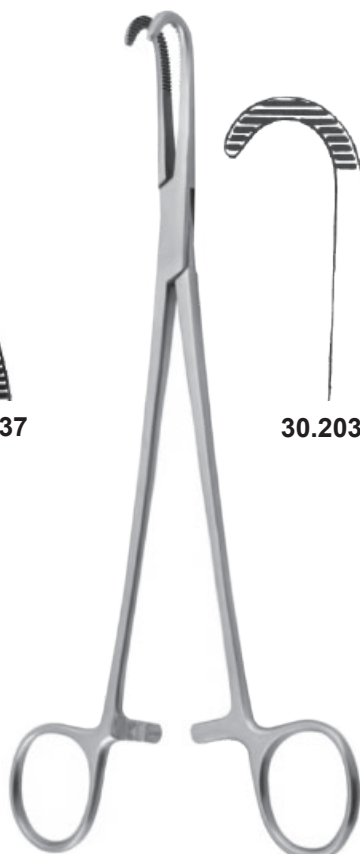

30.2039

Desjardins 210 mm

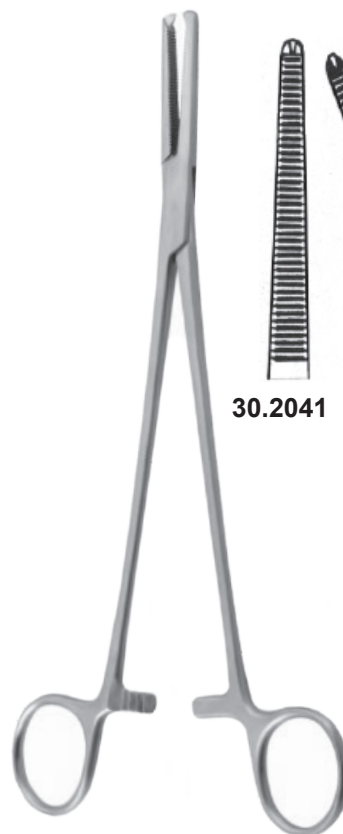

30.2041 **30.2042**

Phaneuf 210 mm



Mayo-Guyon
30.2043
230 mm



Heaney-Ballentine
30.2044 30.2045
210 mm



Heaney
30.2046 190 mm 30.2049
30.2047 210 mm 30.2050
30.2048 230 mm 30.2051



Mikulicz
30.2052.001
180 mm

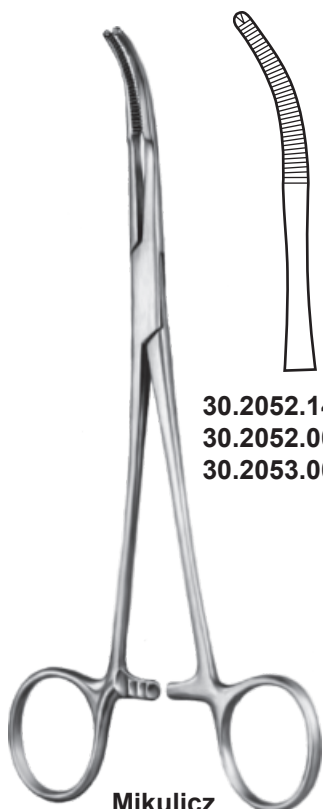

30.2052.140 140 mm
30.2052.000 180 mm
30.2053.000 200 mm 30.2054

Mikulicz

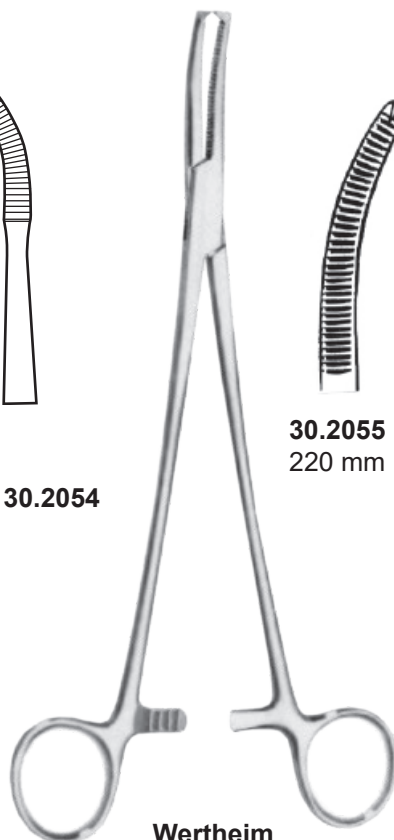

30.2055
220 mm

Wertheim

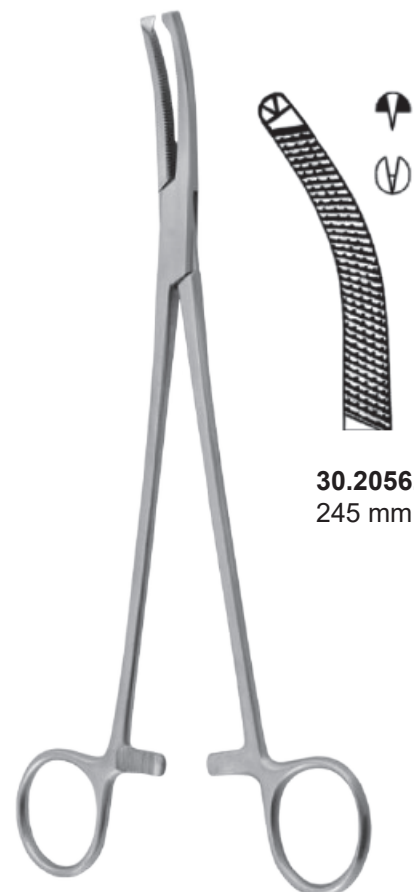

30.2056.100
245 mm

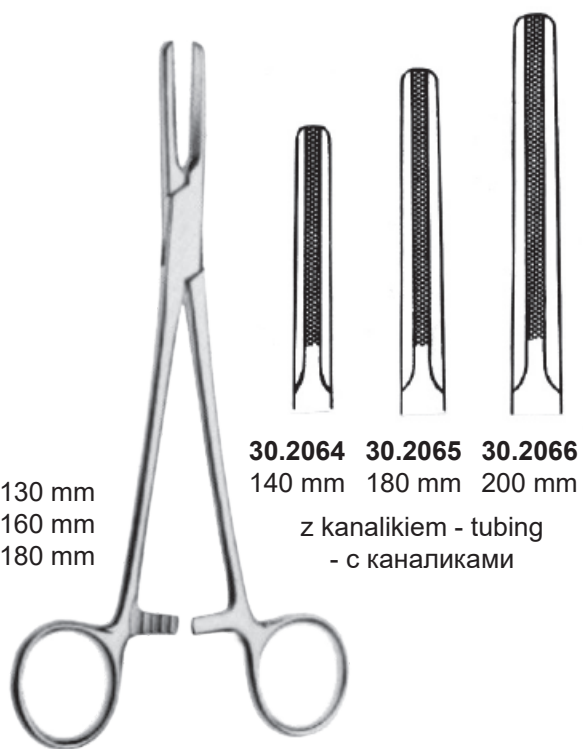
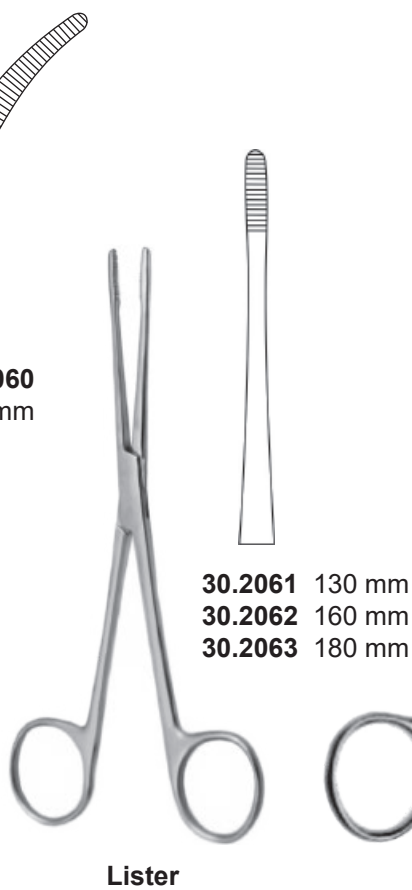
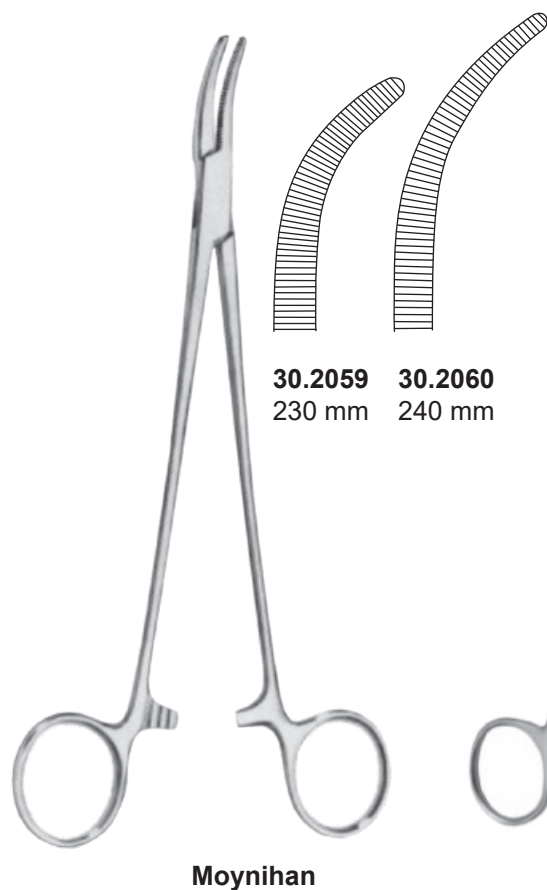
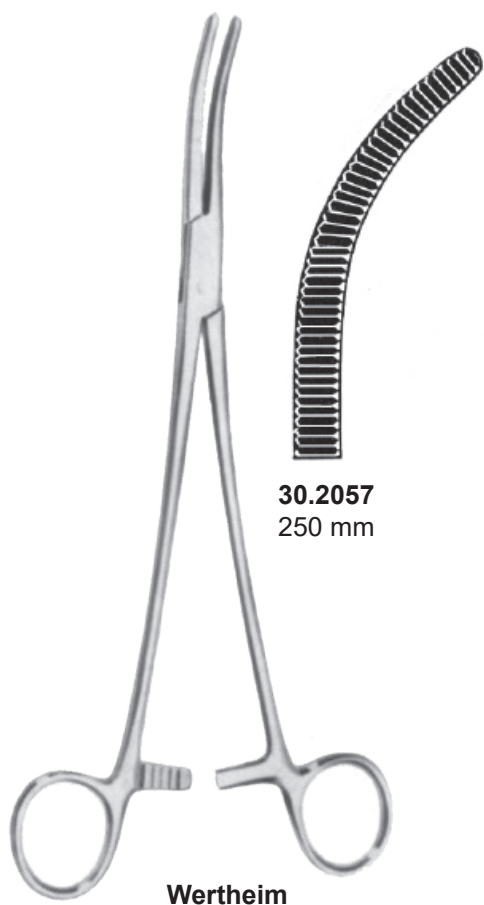



Lane
30.2067 200 mm



Roeder
30.2068 130 mm
30.2069 150 mm



Backhaus
30.2070 90 mm
30.2071 110 mm
30.2072 130 mm
30.2073 150 mm



Lorna
30.2074 100 mm
30.2075 130 mm

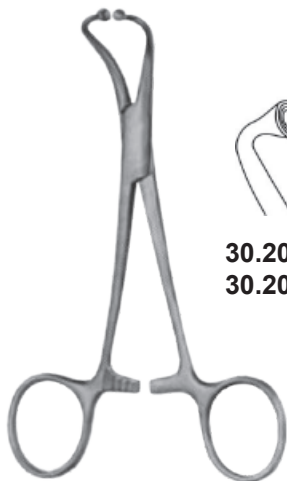

30.2076 110 mm
30.2077 130 mm



30.2078 110 mm
30.2079 130 mm



Doyen
30.2080 180 mm



Jones
30.2082 90 mm

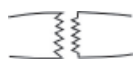

Ombredanne
30.2083 135 mm



30.2089.000
30.2089.250

Gross
200mm
250mm



30.2090.000
30.2090.250

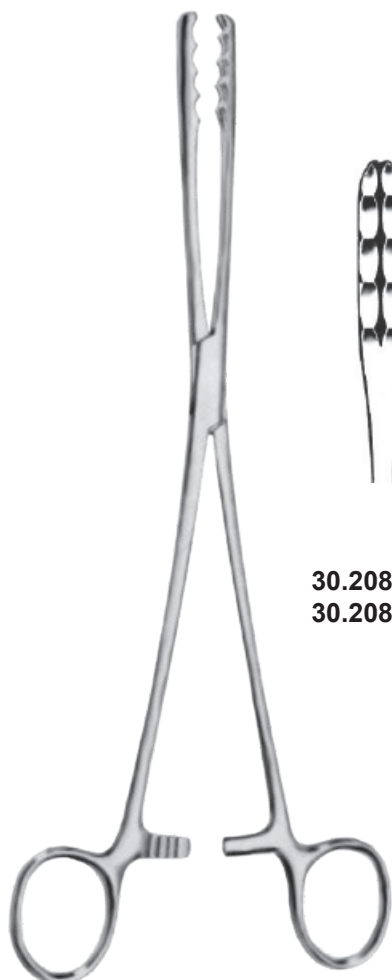

30.2084 200 mm
30.2085 250 mm

Ulrich

30.2086 200 mm
30.2087 250 mm

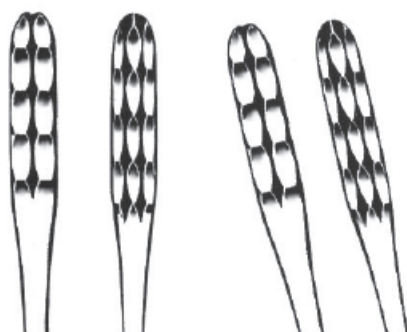

Pears
30.2088 145 mm



Thomas
30.2091 100 mm
30.2092 130 mm

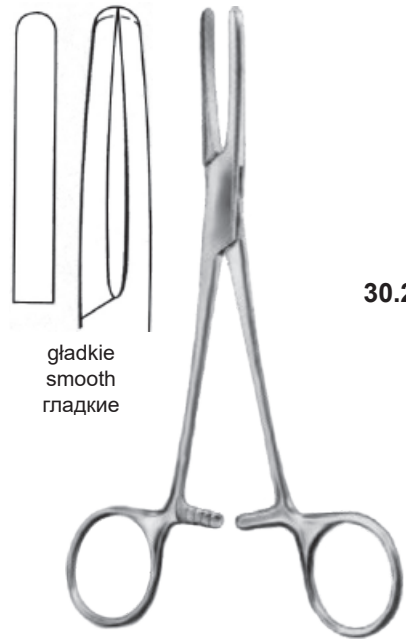

gładkie
smooth
гладкие

Presbyterian
30.2093 160 mm

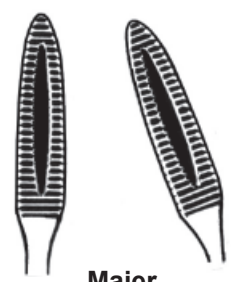

Maier

30.2094 220 mm 30.2096
30.2095 250 mm 30.2097
30.2095.270 270 mm 30.2097.270



Collin
30.2098 250 mm

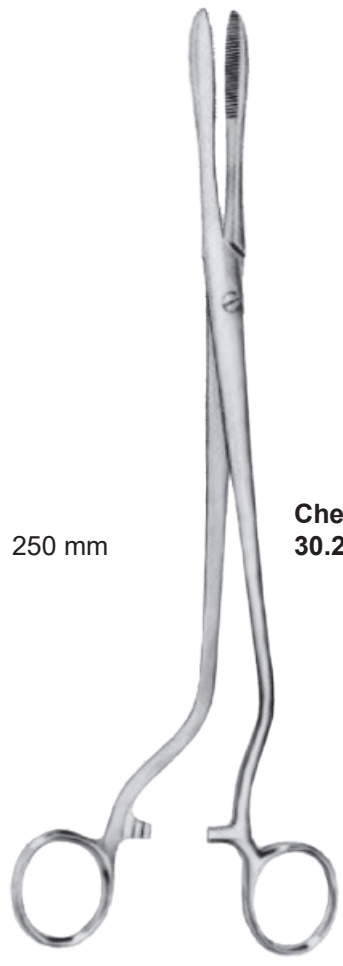

Cheron
30.2099 250 mm

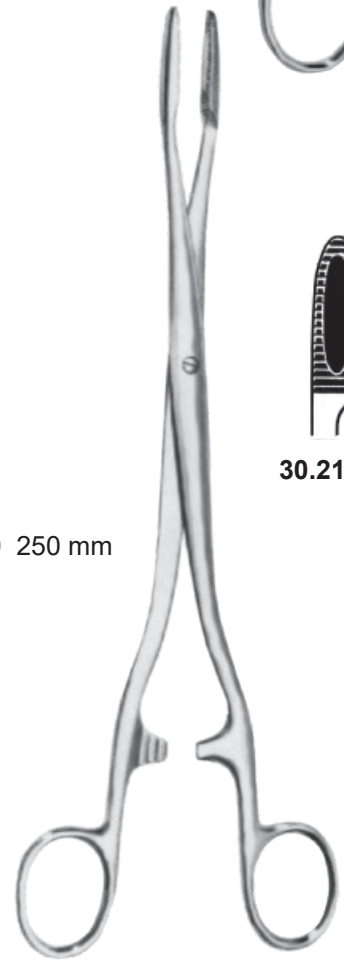

30.2100 30.2101
Duplay
250 mm

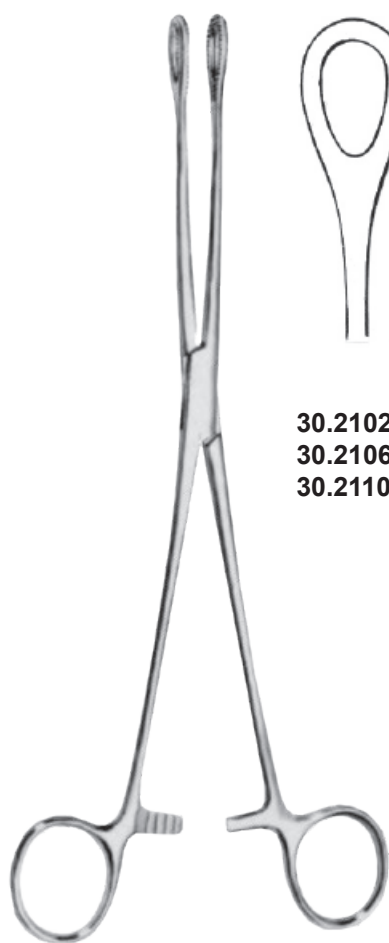

30.2102
30.2106
30.2110

30.2103
30.2107
30.2111

Foerster
180 mm
200 mm
250 mm

30.2104
30.2108
30.2112

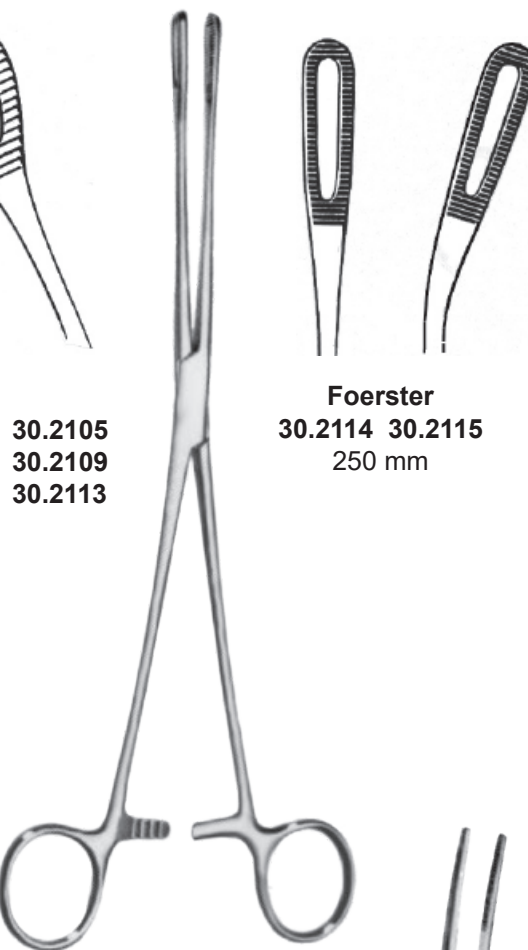

Foerster
30.2114 30.2115
250 mm

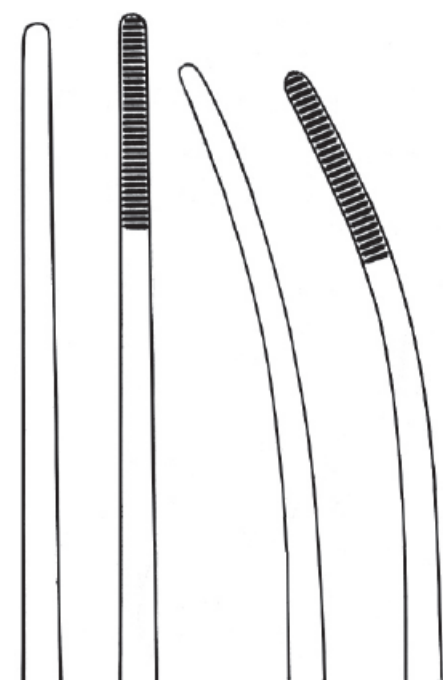

30.2116 30.2117 30.2118 30.2119

Bozemann 260 mm



**Bozemann
-Douglas**
30.2120
260 mm

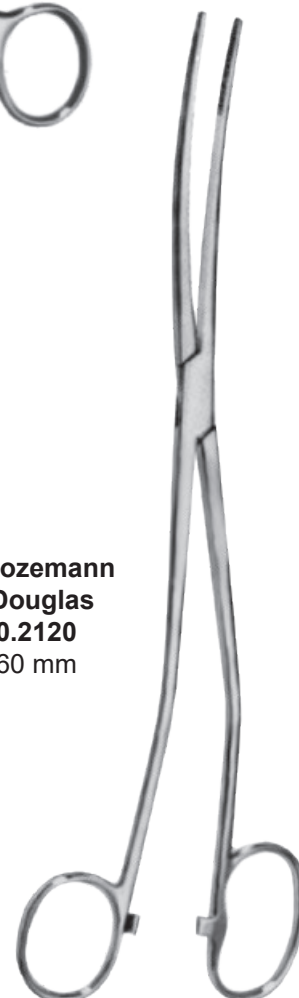



Pelkmann
30.1935
250 mm

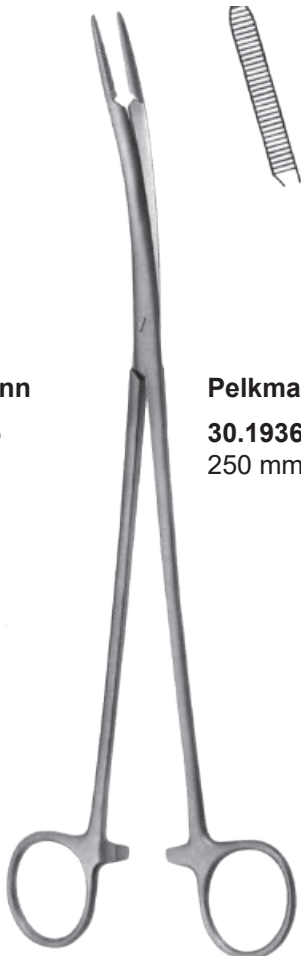

Pelkmann
30.1936
250 mm

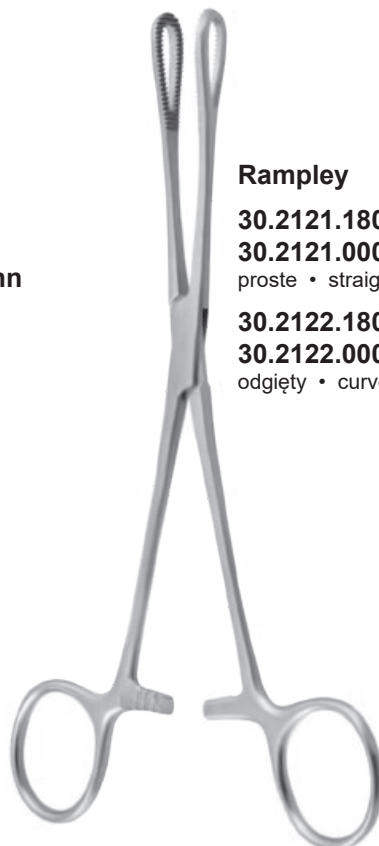

Rampley

30.2121.180 180 mm

30.2121.000 250 mm

proste • straight • прямые

30.2122.180 180 mm

30.2122.000 250 mm

odgięty • curved • изогнутые

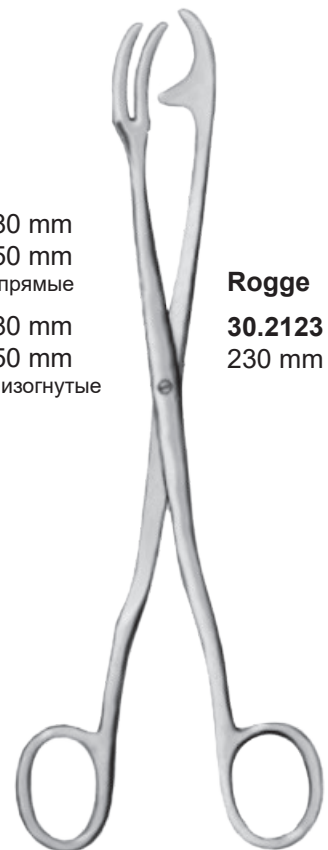

Rogge
30.2123
230 mm

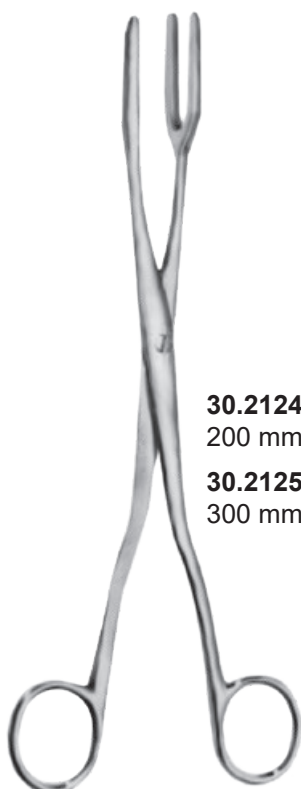

30.2124
200 mm

30.2125
300 mm



Davis

30.2127 160 mm

30.2128 200 mm

30.2129 240 mm



Pennington

30.2130.150 150 mm

30.2130.000 200 mm

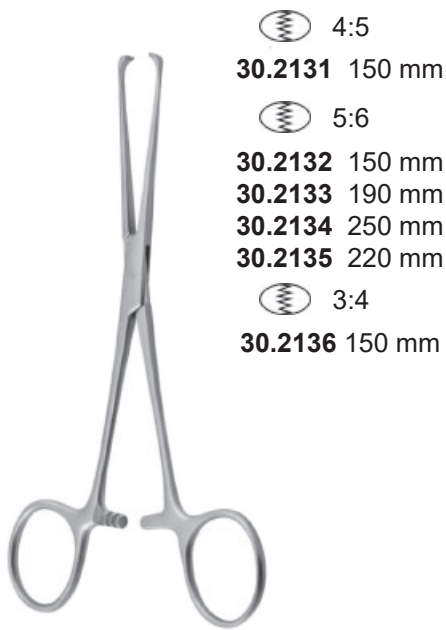

Allis



Allis-Baby



Allis-Adair



Judd-Allis
30.2140 150 mm
30.2141 190 mm



Boys-Allis
30.2142 150 mm



Thoms-Allis
30.2143 200 mm



Lockwood-Allis
30.2144 160 mm
30.2145 200 mm

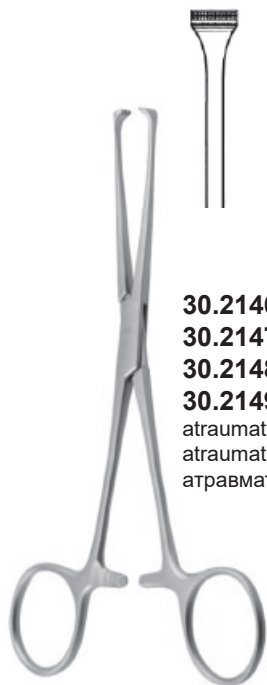

30.2146 155 mm
30.2147 200 mm
30.2148 220 mm
30.2149 250 mm
 atraumatyczne
 atraumatic
 атравматические

Allis

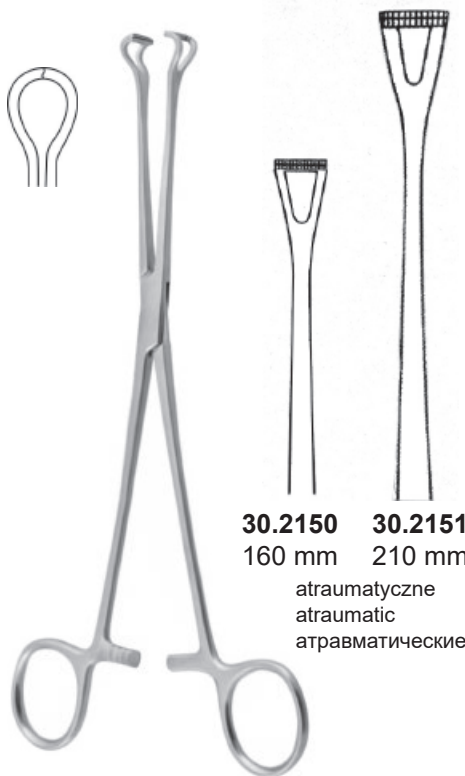

30.2150 160 mm
30.2151 210 mm
 atraumatyczne
 atraumatic
 атравматические

Babcock



30.2152 140 mm
30.2153 160 mm
30.2154 180 mm
30.2155 200 mm
30.2156 240 mm

Babcock



30.2158 150 mm
30.2159 210 mm
30.2160 290 mm
30.2161 350 mm
 bez trzpienia
 without pin
 без стержня

30.2162
30.2163
30.2164
30.2165
 z trzpieniem
 with pin
 со стержне

Payr



Benson
30.2157 155 mm



Williams
30.2166.016 160 mm

z utwardzoną wkładką • with T/C jaws • с усиленными губками



Babcock
30.2167 160 mm
30.2168 200 mm



Allis
30.2169 160 mm
30.2170 190 mm

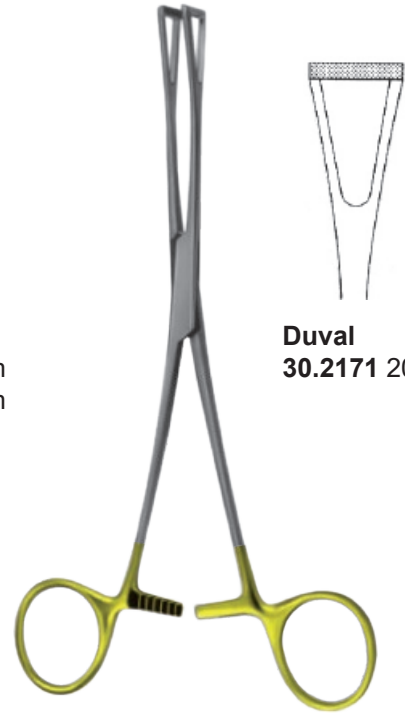

Duval
30.2171 200 mm



Mayo-Robson



30.2172 210 mm 30.2175
30.2173 230 mm 30.2176
30.2174 250 mm 30.2177



Doyen

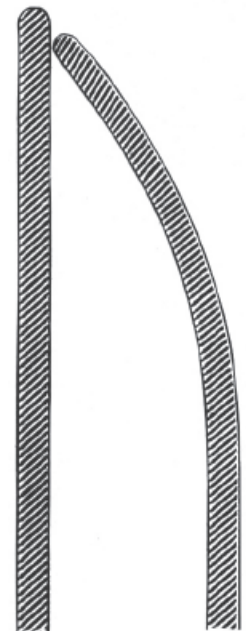

30.2178 170 mm 30.2181
30.2179 210 mm 30.2182
30.2180 230 mm 30.2183

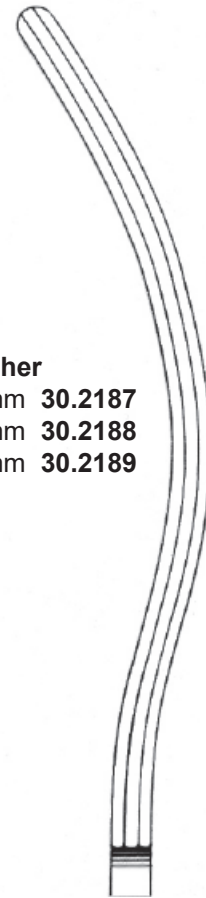

Kocher

- | | | |
|----------------|--------|----------------|
| 30.2184 | 220 mm | 30.2187 |
| 30.2185 | 250 mm | 30.2188 |
| 30.2186 | 280 mm | 30.2189 |

atraumatyczne • atraumatic • атравматические

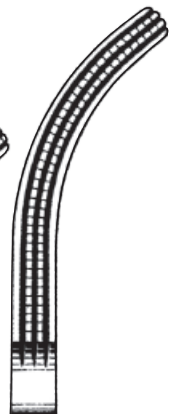
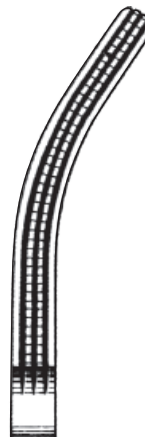
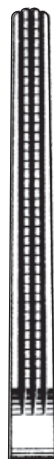

Rogers

- | | |
|----------------|--------|
| 30.1947 | 220 mm |
| 30.1948 | 255 mm |

- | | |
|----------------|--------|
| 30.1949 | 215 mm |
| 30.1950 | 250 mm |

- | | |
|----------------|--------|
| 30.1951 | 210mm |
| 30.1952 | 245 mm |

atraumatyczne • atraumatic • атравматические



30.0079.025 25cm



30.0079.026 26cm

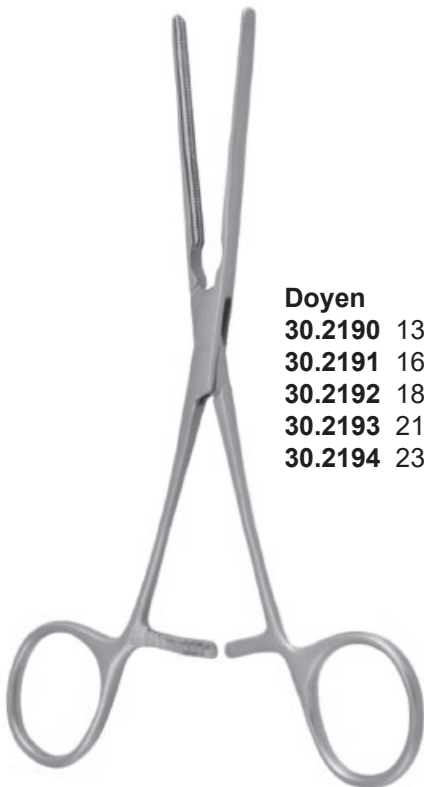

Doyen
30.2190 130 mm
30.2191 160 mm
30.2192 180 mm
30.2193 210 mm
30.2194 230 mm

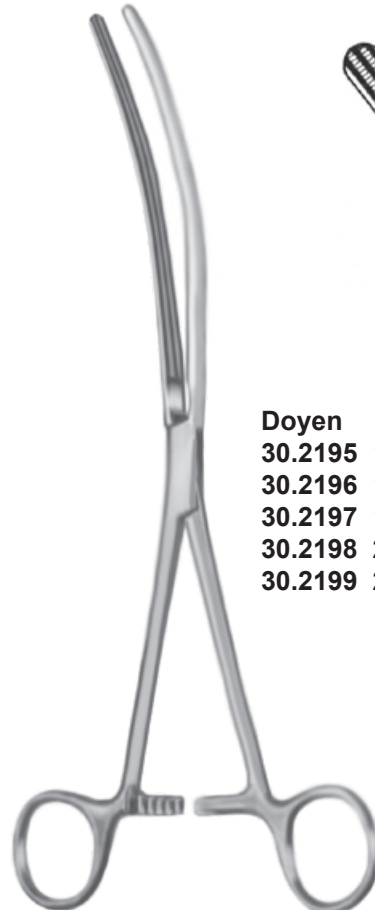

Doyen
30.2195 130 mm
30.2196 160 mm
30.2197 180 mm
30.2198 210 mm
30.2199 230 mm

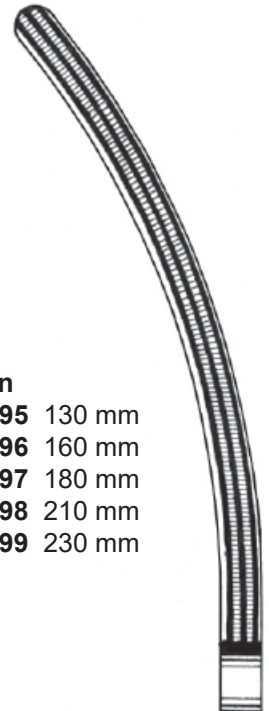

atraumatyczne - atraumatic- атравматические

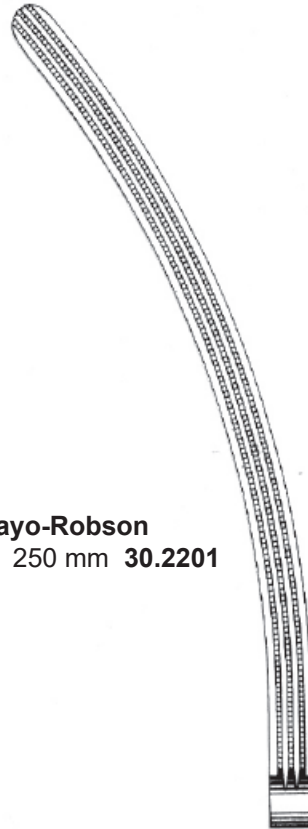

Mayo-Robson
 30.2200 250 mm 30.2201

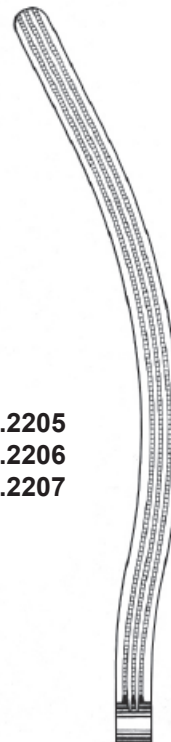
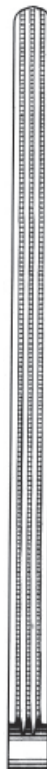

Kocher
 30.2202 220 mm 30.2205
 30.2203 250 mm 30.2206
 30.2204 280 mm 30.2207

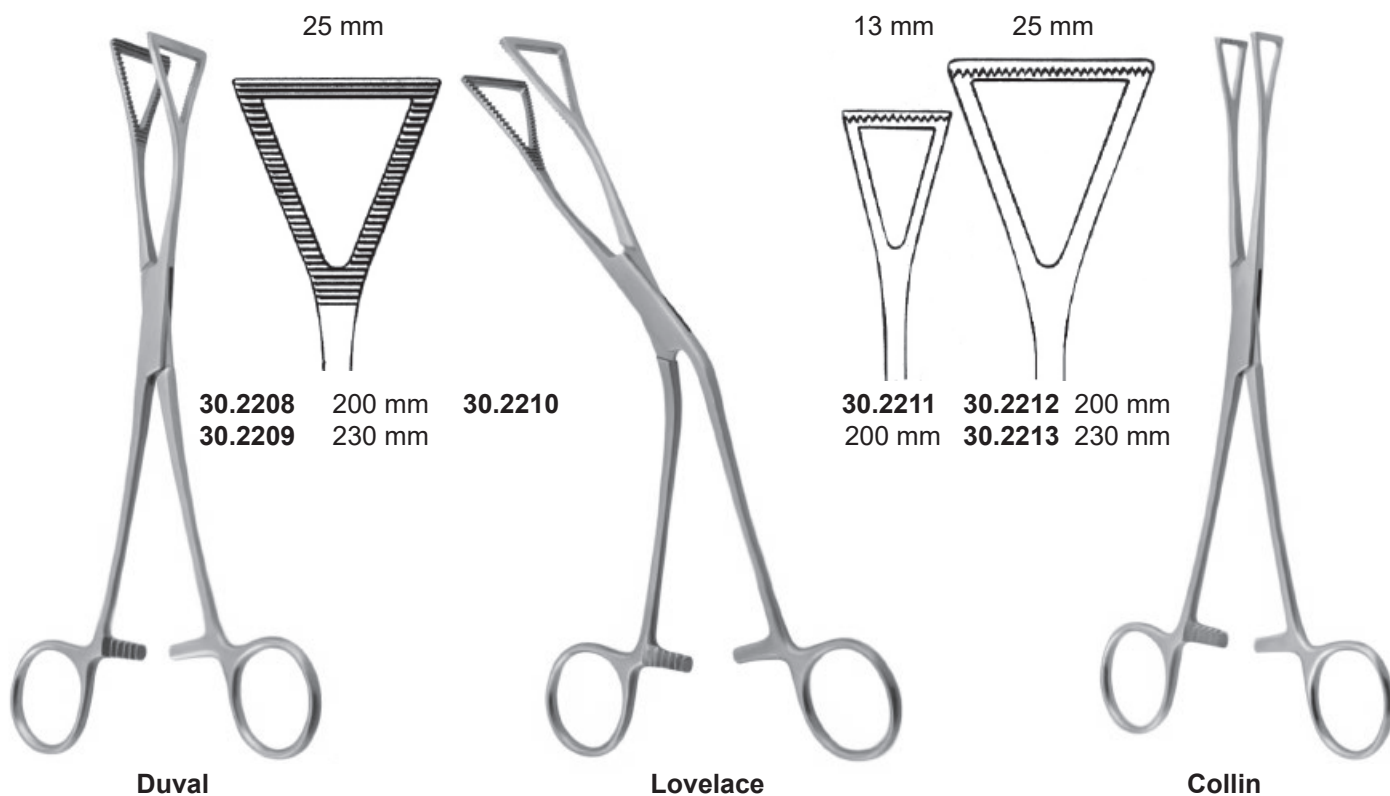

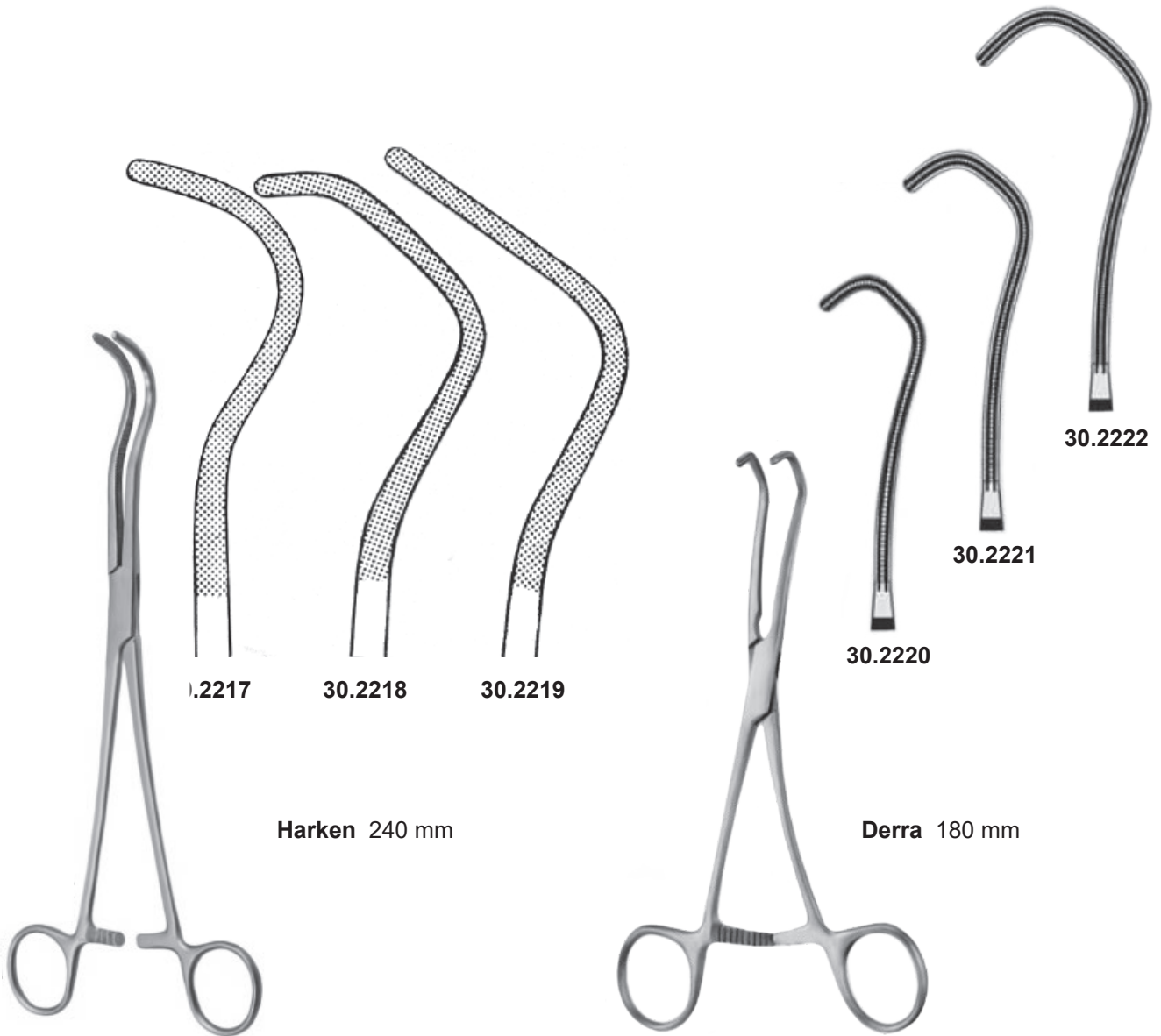

Harken 240 mm

Derra 180 mm



Trousseau
30.2223 140 mm



Laborde
30.2224 140 mm



Satinsky 265 mm

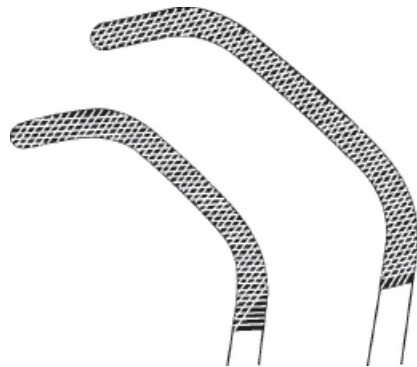

**Fig. 1
30.2225**

**Fig. 2
30.2226**



Satinsky 265 mm

**Fig. 1
30.2227**

**Fig. 2
30.2228**

kształt S
S-shaped
форма S



**Baby-Satinsky
30.2229 150 mm**



Schröder
30.2512
proste
straight
прямые

30.2513
odgięte do przodu
curved forwards
изогнутые вперёд
240 mm

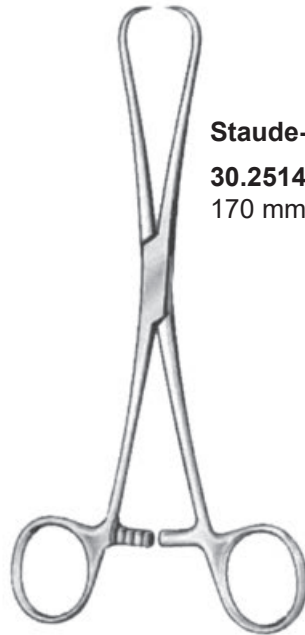

Staude-Moore
30.2514
170 mm



Czerny
30.2515
200 mm

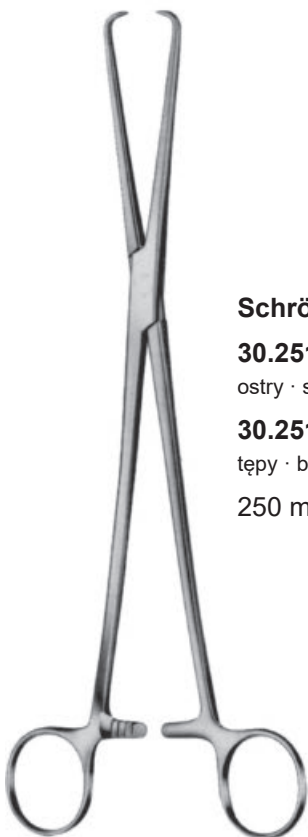

Schröder-Brown
30.2516
ostrzy · sharp · острый
30.2517
tępy · blunt · тупый
250 mm



Brown
30.2518
250 mm



Teale
30.2519
230 mm

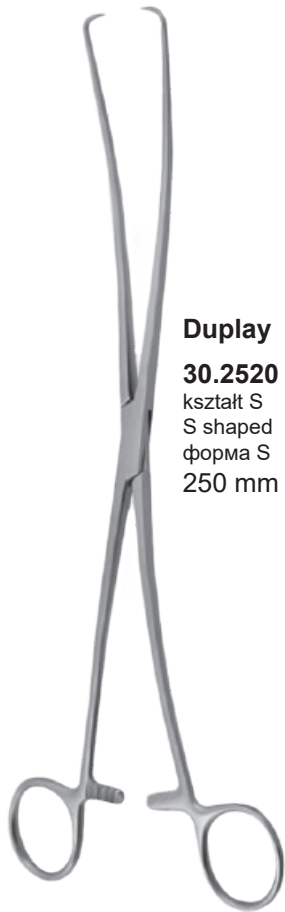

Duplay
30.2520
kształt S
S shaped
форма S
250 mm



Skene
30.2521
240 mm



Jacobs
30.2522
proste • straight • прамые
30.2523
odgięte do przodu
curved forwards
изогнутые вперед
30.2524
odgięte w bok
curved sideways
изогнутые на бок
210 mm

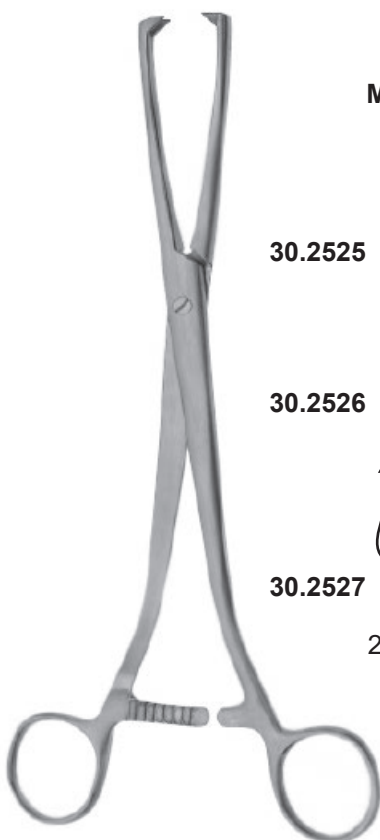

Museux



30.2525 6 mm **30.2528**



6 mm



30.2526 8 mm **30.2529**



8 mm



30.2527 10 mm **30.2530**



10 mm

240 mm

odgięte w bok
curved sideways
изогнутые на бок



Pozzi
30.2590.180
180 mm
30.2590.250
250 mm



De Bakey
190 mm

30.2230
ø 0,5 mm

30.2231
ø 1,0 mm

30.2232
ø 1,5 mm

30.2233
ø 2,0 mm

30.2234
ø 2,5 mm

30.2235
ø 3,0 mm

30.2236
ø 3,5 mm

30.2237
ø 4,0 mm

30.2238
ø 4,5 mm

30.2239
ø 5,0 mm

30.2240
ø 7,0 mm

30.2241
ø 9,0 mm



Nabatoff
30.2242

135x100x25 mm
 Komplet nie zawiera końcówki Ø15 mm
 Set does not include the olive of Ø15 mm
 Набор не включает оливы Ø15 мм

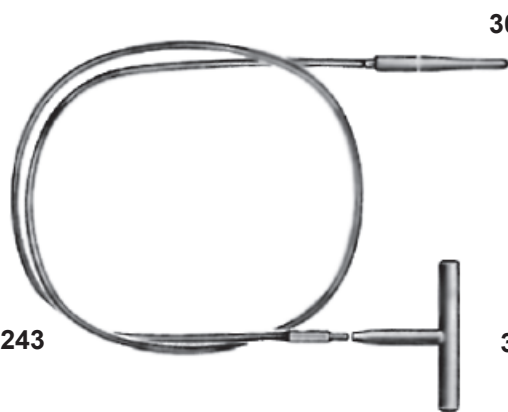

30.2243

30.2245

30.2244

30.2246
Metalowa kasetka
Metal case
Только кассета



30.2247
ø 3,0 mm



30.2248
ø 6,0 mm



30.2249
ø 9,0 mm



30.2250
ø 12,0 mm



30.2251
ø 15,0 mm



30.3510.000 140 mm



30.3510.115 115 mm
30.3510.130 130 mm
30.3510.145 145 mm
30.3510.160 160 mm
30.3510.180 180 mm
30.3510.200 200 mm



30.3511.115 115 mm
30.3511.130 130 mm
30.3511.145 145 mm
30.3511.160 160 mm
30.3511.180 180 mm



30.3512.160 160 mm



30.3512.200 200 mm



30.2252
230 mm

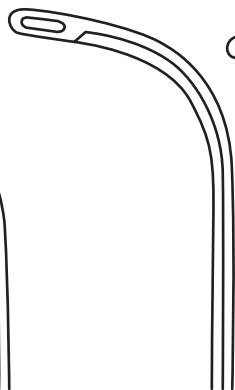

30.2253
220 mm

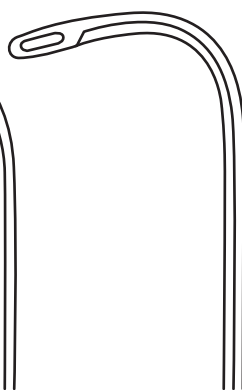

30.2254
220 mm

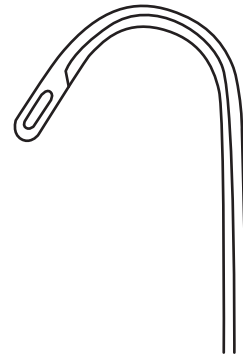

30.2255
220 mm

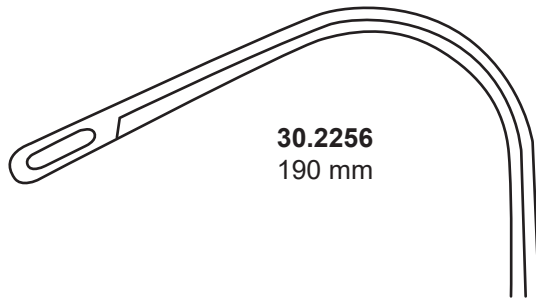

30.2256
190 mm

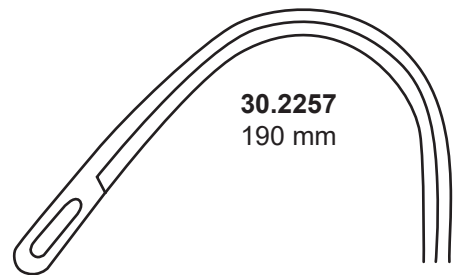

30.2257
190 mm



30.2258



30.2259

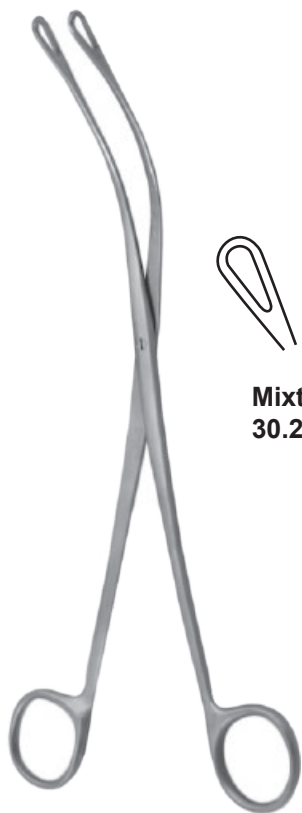

Mixer
30.2261 220 mm

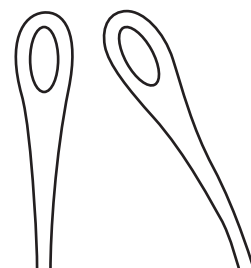

Blake 200 mm
30.2262 30.2263

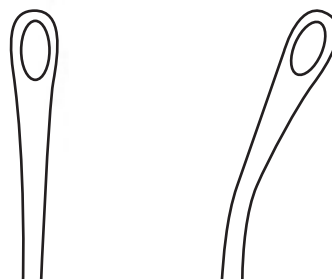

Mayo-Blake 200 mm
30.2264 30.2265



30.2266
 Ø 4 mm

Mayo 320 mm
 giętka
 malleable
 пружинчатая



30.2267 4 mm
30.2268 5 mm
30.2269 6 mm

Desjardins 280 mm
 elastyczna
 flexible
 эластичная

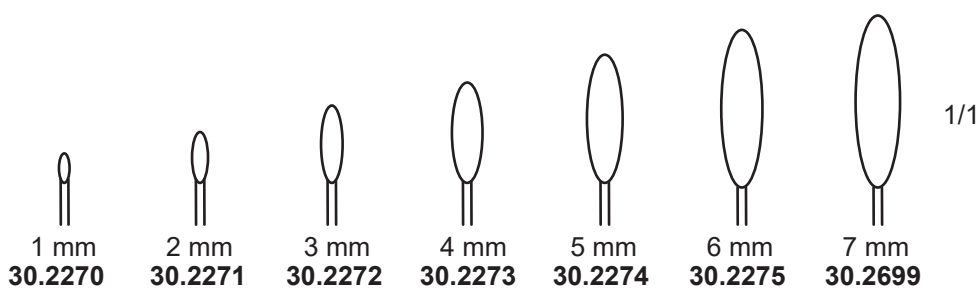

1/1

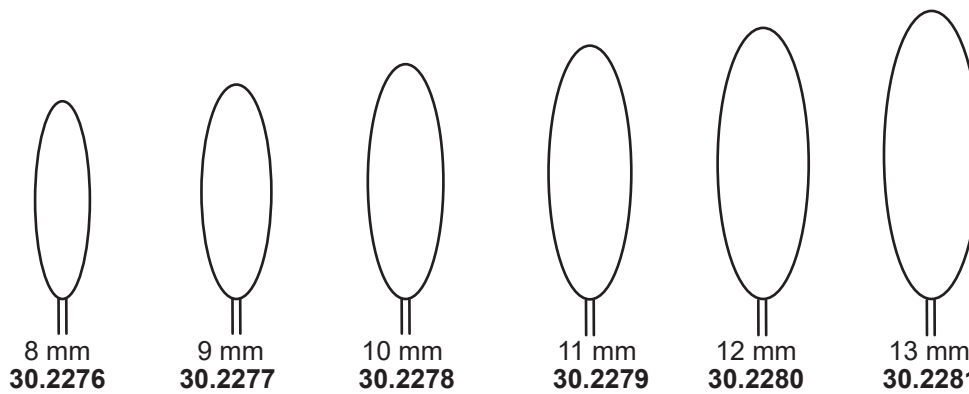

1/1

Bakes
 300 mm



30.2282
2,5 mm



30.2283
3,2 mm



30.2284
3,6 mm



30.2285
5,5 mm



30.2286
6,7 mm



30.2287
8 mm



30.2288
11 mm



30.2289
15 mm



Luer-Koerte
320 mm

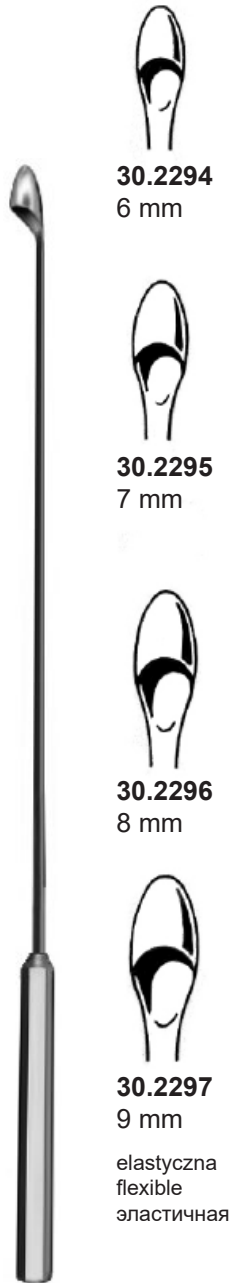

Desjardins
300 mm

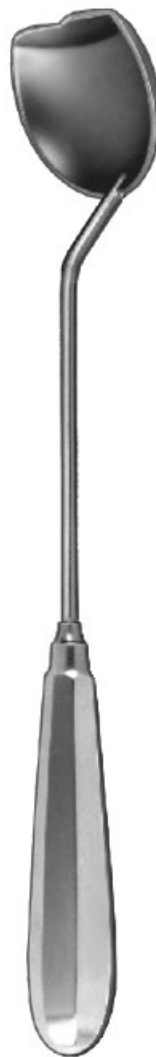

Moore
30.2298
280 mm



Mayo
30.2299
280 mm



Rochester
30.1937
 230 mm



Best
30.1938
 230 mm



Bevan
30.1939
 210 mm





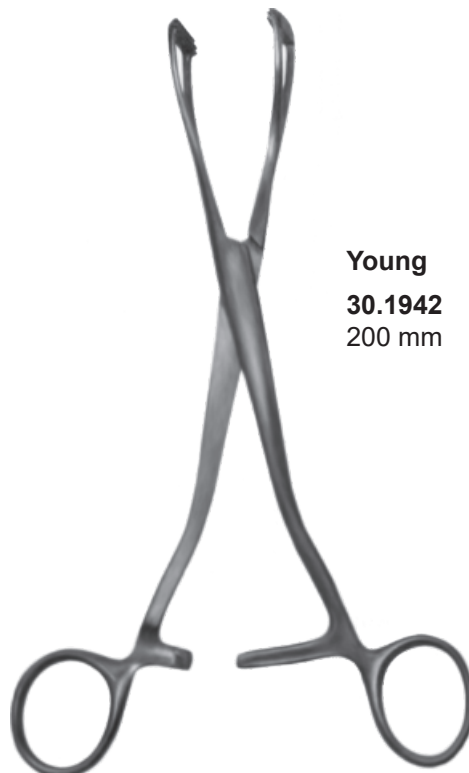

Lewkowitz
30.1940 245 mm **30.1941**

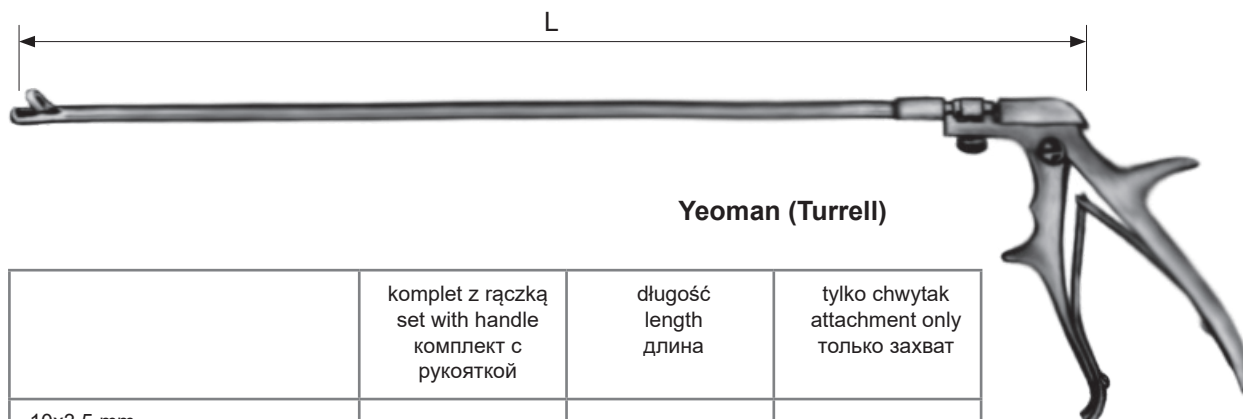

Young
30.1942
 200 mm



Yeoman (Turrell)

	komplet z rączką set with handle комплект с рукояткой	długość length длина	tylko chwytak attachment only только захват
10x3,5 mm 	30.2923 30.2924	330 mm 400 mm	30.2931 30.2932
10x3,5 mm 	30.2925 30.2926	330 mm 400 mm	30.2933 30.2934
10x3,5 mm 	30.2927 30.2928	330 mm 400 mm	30.2935 30.2936
10x3,5 mm 	30.2929 30.2930	330 mm 400 mm	30.2937 30.2938



Universal
30.3112



Yeoman
30.3113



Walton
30.3114

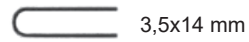
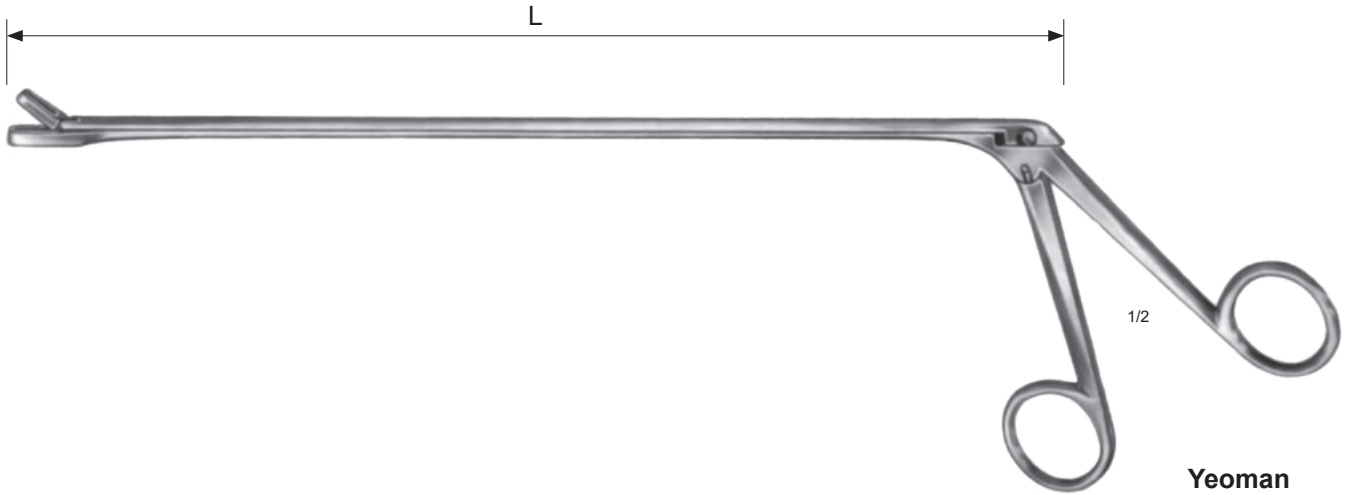

L= 280 mm **30.3118**
 L= 350 mm **30.3119**
 L= 420 mm **30.3120**

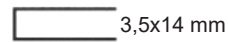
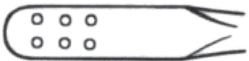

L= 280 mm **30.3124**
 L= 350 mm **30.3125**
 L= 420 mm **30.3126**



hemoroidalne • haemorrhoidal • геморроидальные



McGivney
30.1943
190 mm



McGivney
30.1944
190 mm



Laufe
30.1945
200 mm



Pratt
30.1946
150 mm

do wprowadzania cewników • catheter • для поставки катетеров



Magill-Baby
30.1953
150 mm
dla dzieci
for children
для детей



Magill
30.1954
200 mm
dla dzieci
for children
для детей



Magill
30.1955
250 mm
dla dorosłych
for adults
для взрослых



Michel
30.4230
125 mm



Collin
30.4231
135 mm



Michel
30.4233
120 mm



Michel
30.4234
120 mm



Hagenbarth
30.4235
125 mm



Wachenfeldt
30.4236
125 mm



30.1421 30.1422 30.1423

Krayenbühl

30.1420
185 mm



90°

30.1424
185 mm



90°

Fisch

30.1425
185 mm



Dandy

30.1426
200 mm



Smithwick

30.1427 170 mm
30.1428 210 mm



ostry
sharp
острый

Sachs

30.1429
185 mm



ostry
sharp
острый

Toennis

30.1430
150 mm



Graham
30.1431
165 mm



Adson
30.1432
200 mm



Adson
30.1433
200 mm

13x6 mm



Schoenborn
30.1434
210 mm



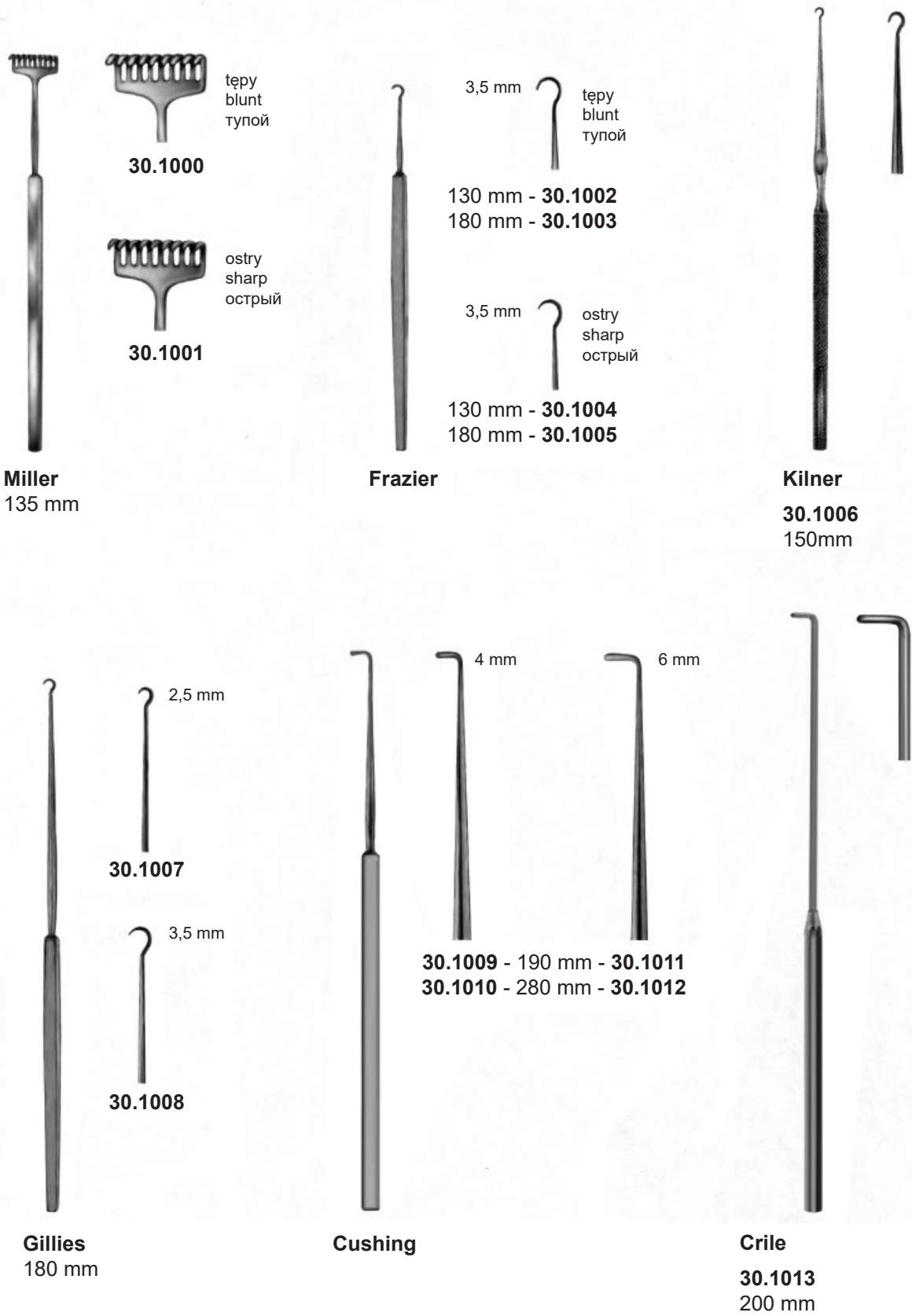

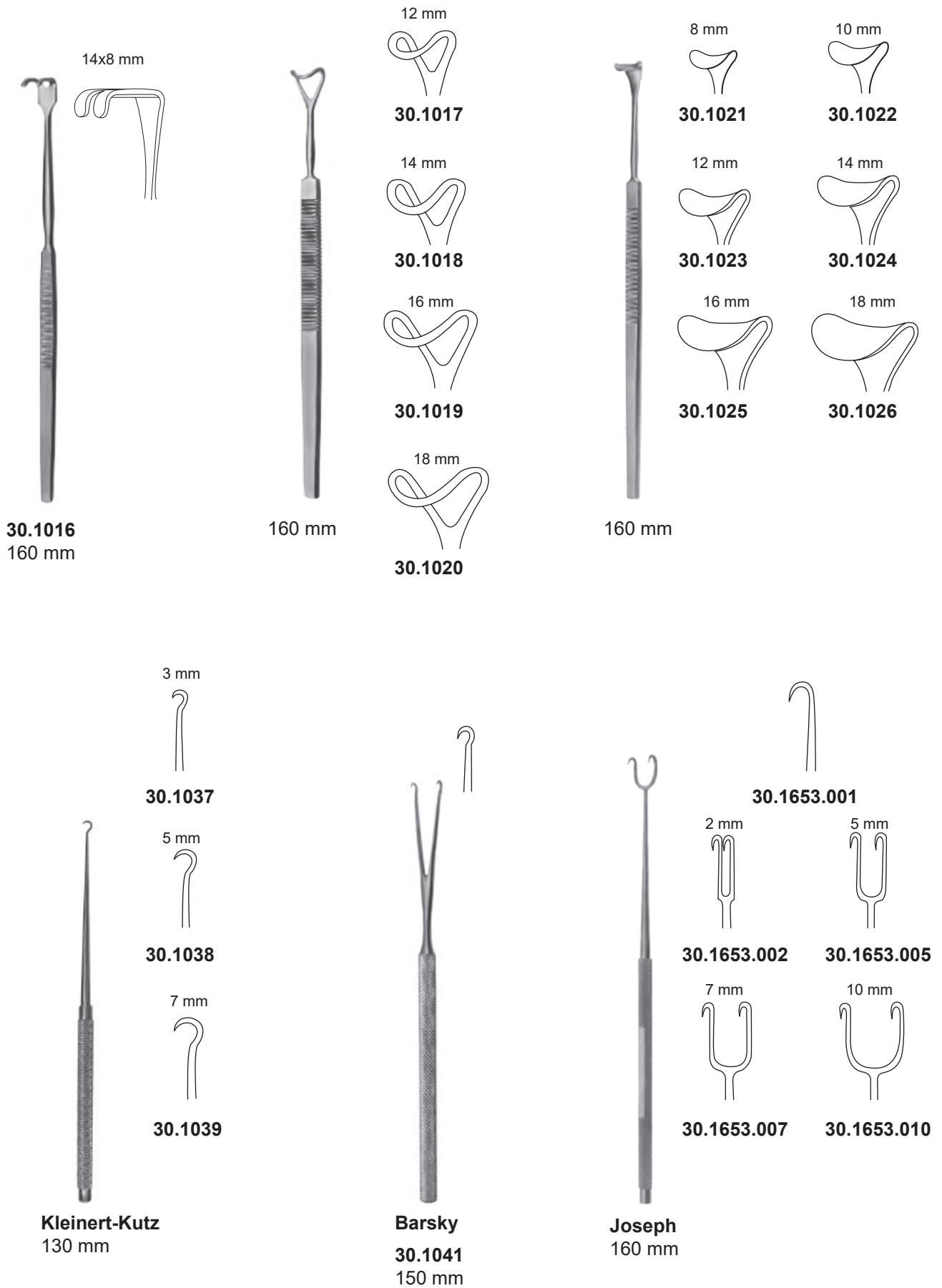

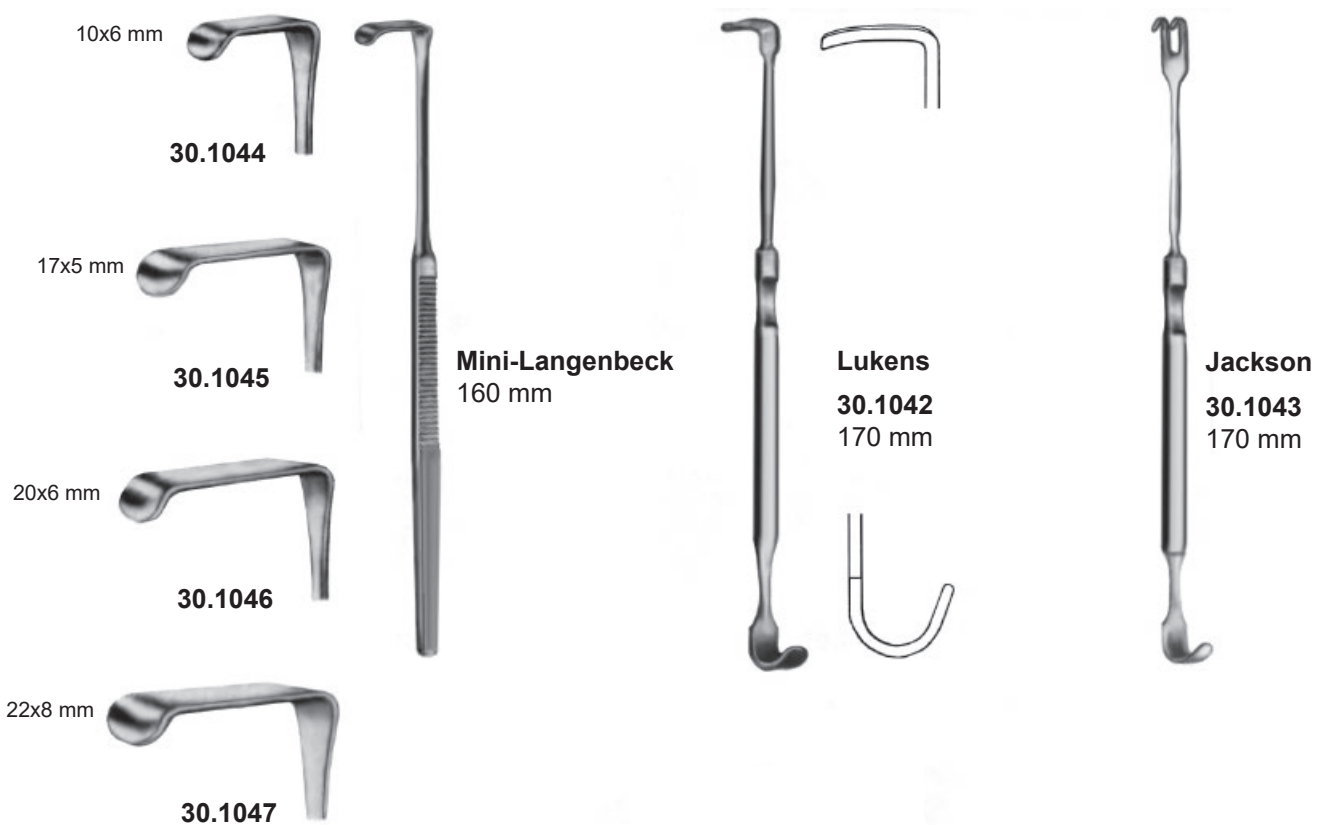
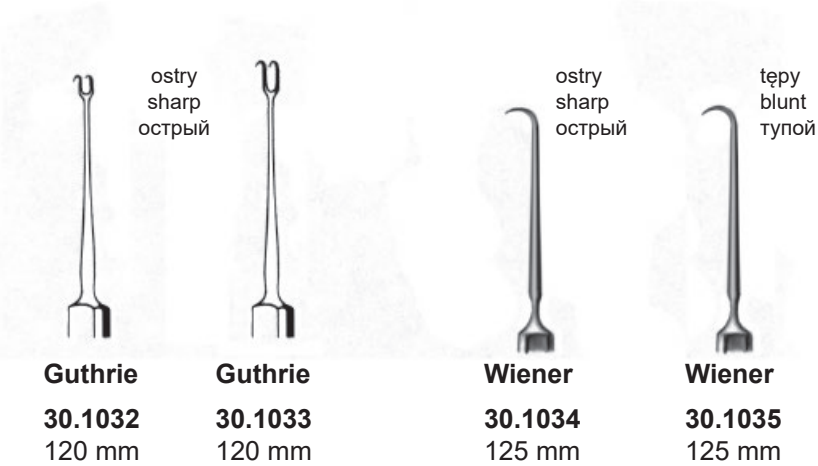
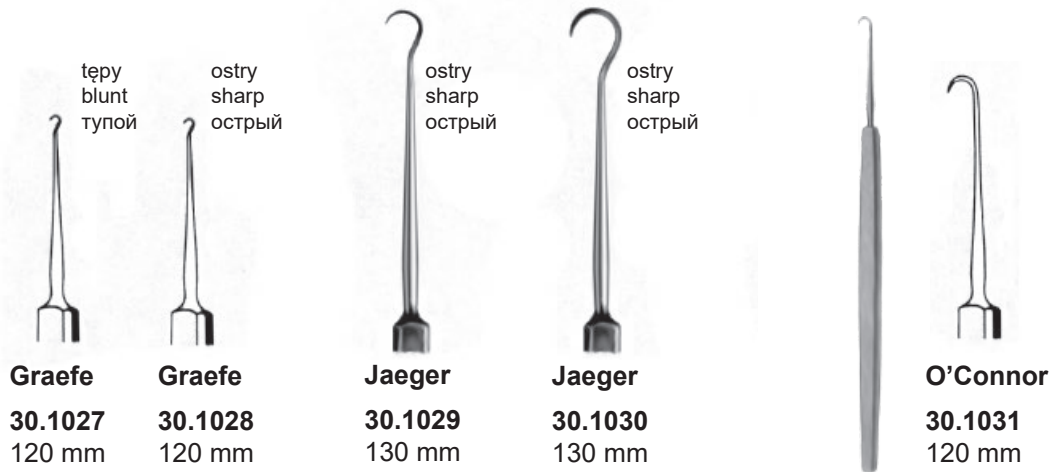



160 mm

tępy
blunt
тупой



30.1048



30.1049



30.1050



30.1051

ostry
sharp
острый



30.1052



30.1053



30.1054



30.1055



30.1056



30.1057



30.1058



30.1059

tępy
blunt
тупой



30.1060



30.1061



30.1062



30.1063

ostry
sharp
острый



160 mm



160 mm

tępy
blunt
тупой



30.1064



30.1065



30.1066



30.1067

giętki
flexible
гибкий

ostry
sharp
острый



30.1068



30.1069



30.1070



30.1071

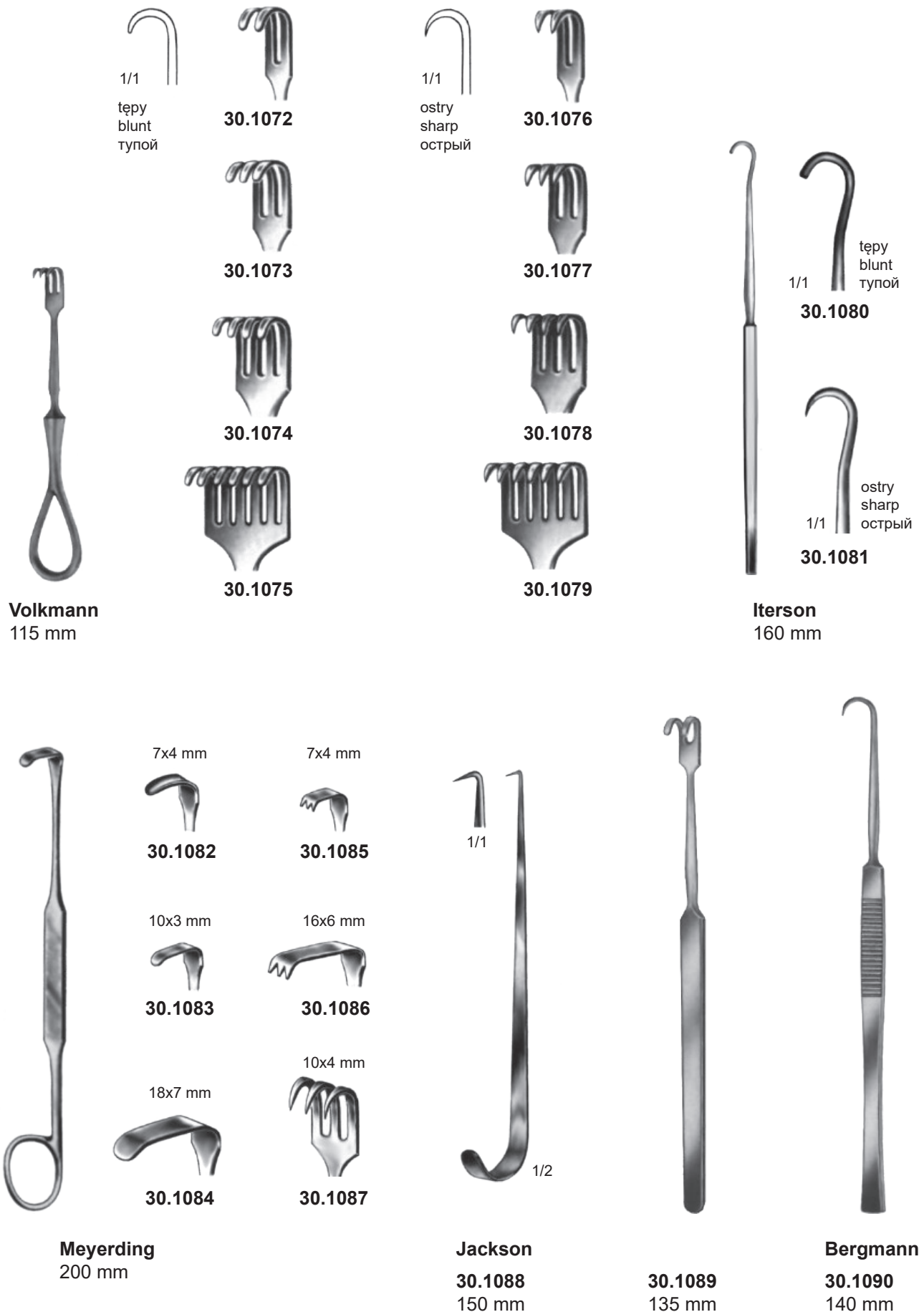



- 30.1091 8 mm
- 30.1092 11 mm
- 30.1093 15 mm
- 30.1094 17 mm
- 30.1095 20 mm
- 30.1096 23 mm

Gil-Vernet
240 mm



- 30.1097 10 mm
- 30.1098 15 mm
- 30.1099 20 mm
- 30.1100 30 mm
- 30.1101 40 mm
- 30.1102 50 mm

Love (Morse)
250 mm



12x14 mm

Little
30.1103
200 mm



Cushing
200 mm

8 mm



30.1104

10 mm



30.1105

12 mm



30.1106

14 mm



30.1107

16 mm



30.1108

18 mm



30.1109



Cushing
240 mm

8 mm



30.1110

10 mm



30.1111

12 mm



30.1112

14 mm



30.1113

16 mm



30.1114

18 mm



30.1115

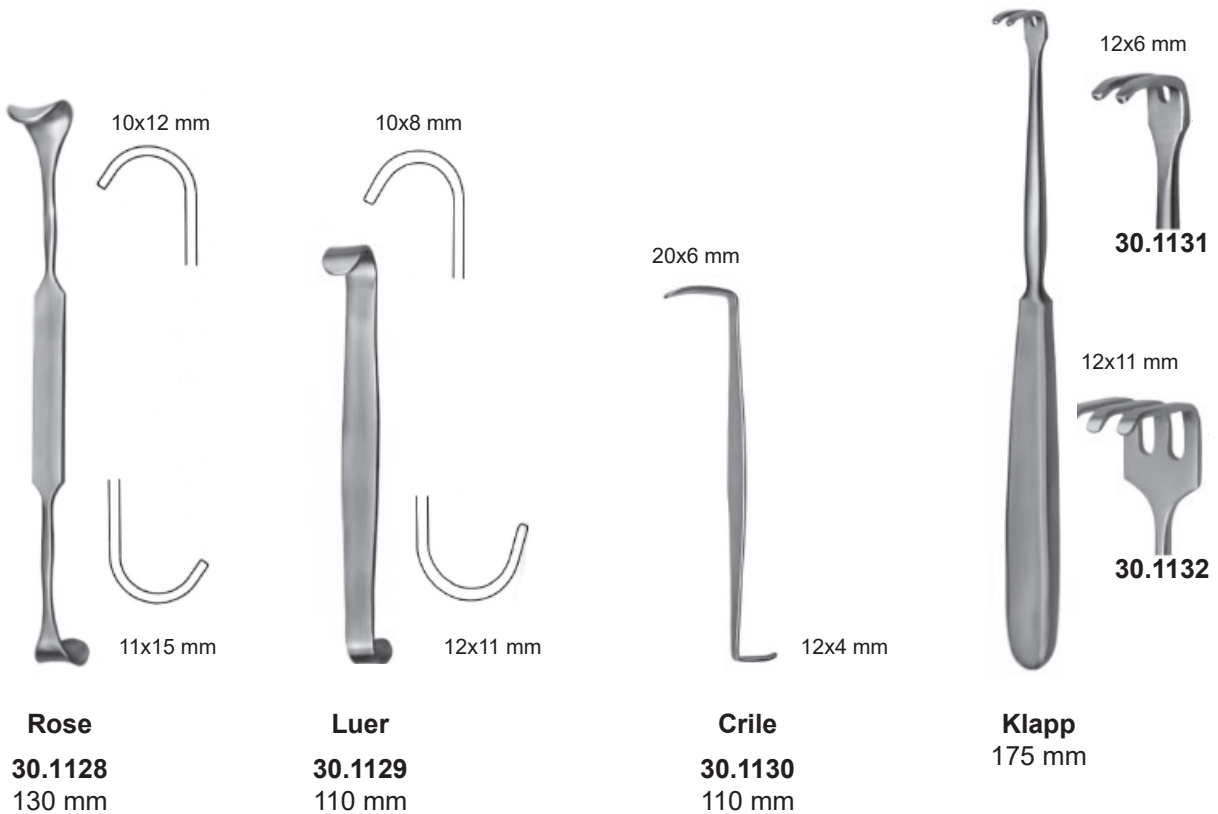
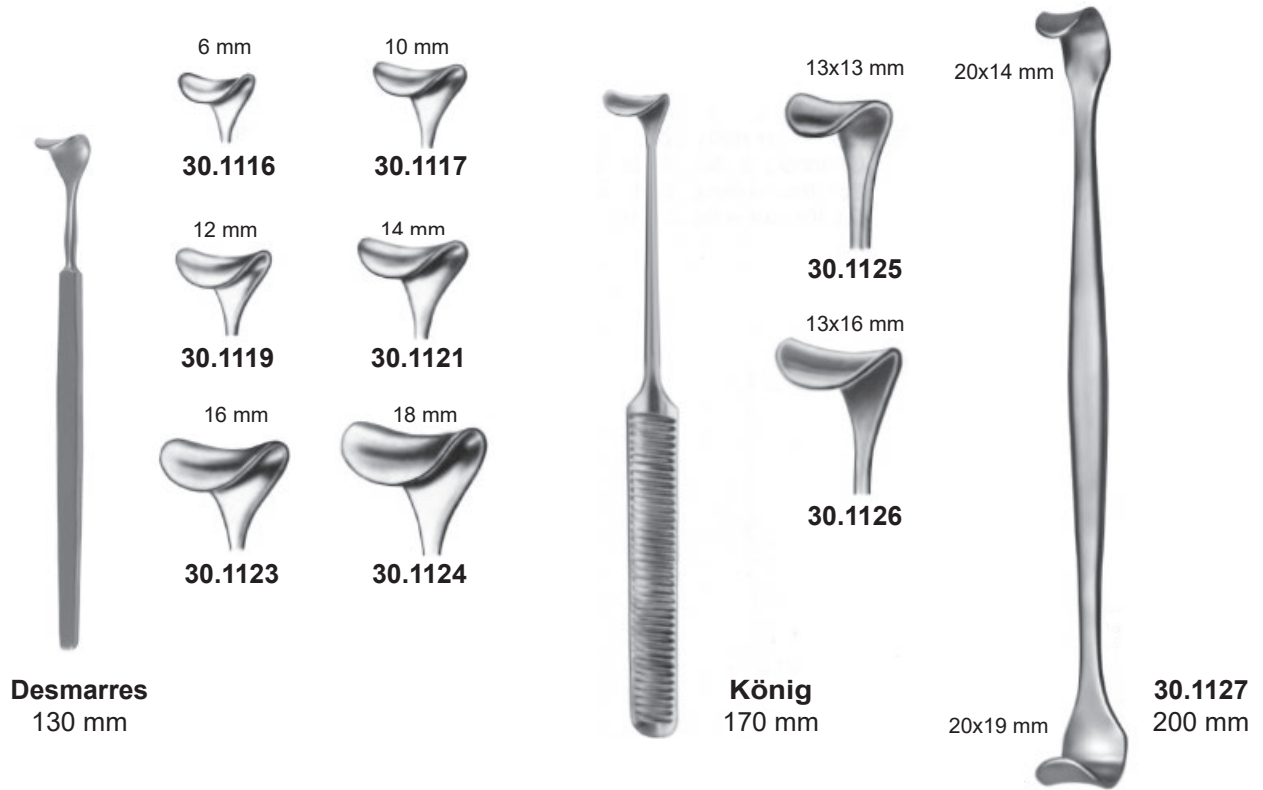

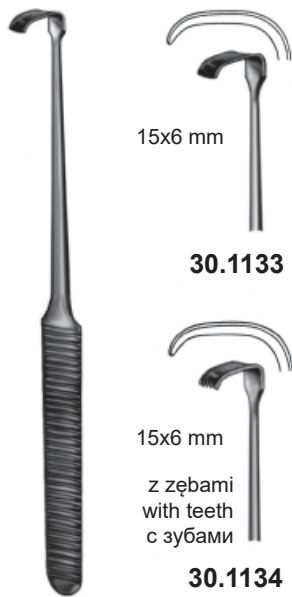

Strandell-Stille
190 mm



Cushing
30.1135
200 mm

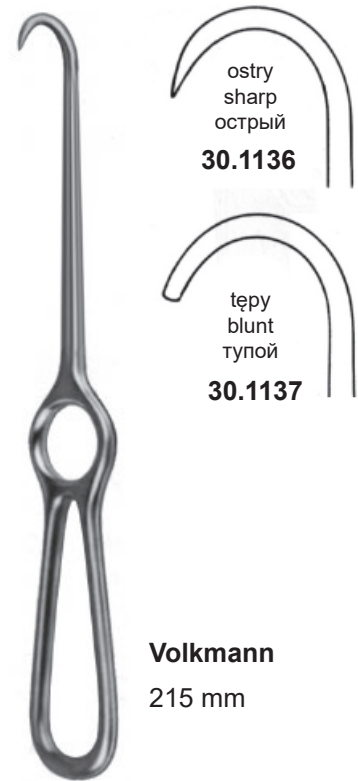

Volkmann
215 mm

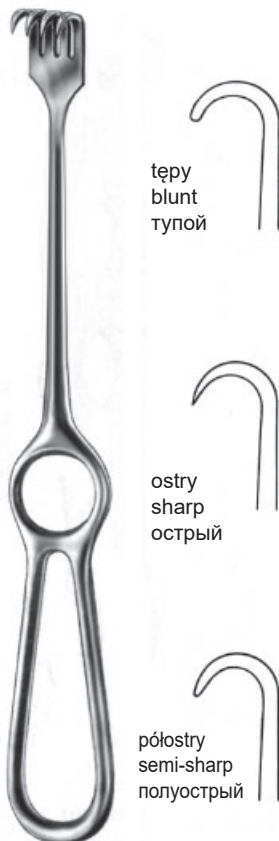

Volkmann
215 mm

8x9 mm



30.1138

13x9 mm



30.1139

19x9 mm



30.1140

29x9 mm



30.1141

40x9 mm



30.1142

tępy
blunt
тупой

8x9 mm



30.1143

13x9 mm



30.1144

19x9 mm



30.1145

29x9 mm



30.1146

40x9 mm



30.1147

ostry
sharp
острый

8x9 mm



30.1148

13x9 mm



30.1149

19x9 mm



30.1150

29x9 mm



30.1151

40x9 mm



30.1152

półostry
semi-sharp
полустрый

Volkman 230 mm



Kocher 220 mm

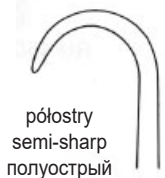
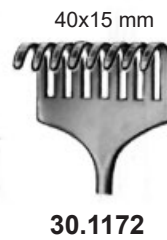
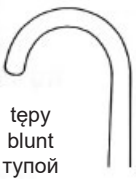



tępy
blunt
тупой



Kocher
30.1167
215 mm



ostrzy
sharp
острый



Kocher
30.1173
215 mm



ostrzy
sharp
острый



Kocher
30.1180
215 mm



tępy
blunt
тупой



Kocher
30.1181
215 mm

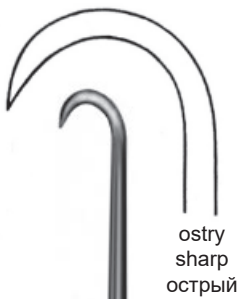

ostrzy
sharp
острый



30.1182
245 mm

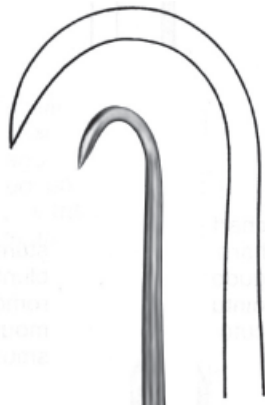

ostrzy
sharp
острый



Volkman
30.1183
215 mm



tępy
blunt
тупой



Volkman
30.1184
215 mm



40.7216
230 mm

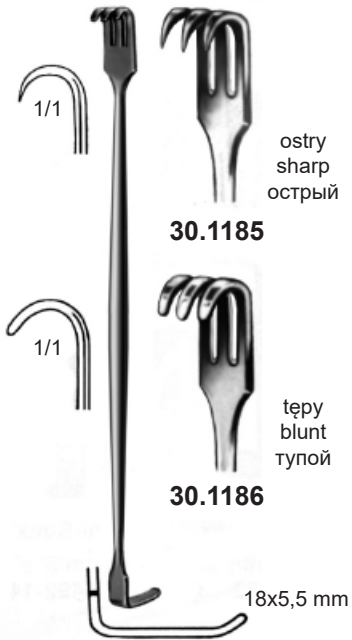

Senn-Miller
160 mm

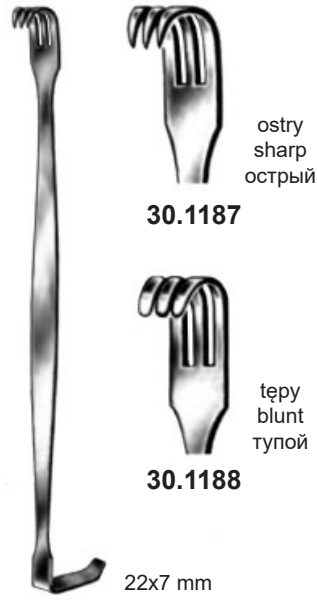

Baby-Senn-Miller
160 mm



Senn-Green
160 mm



Ragnell-Davis
30.1191
140 mm



Langenbeck-Green
160 mm

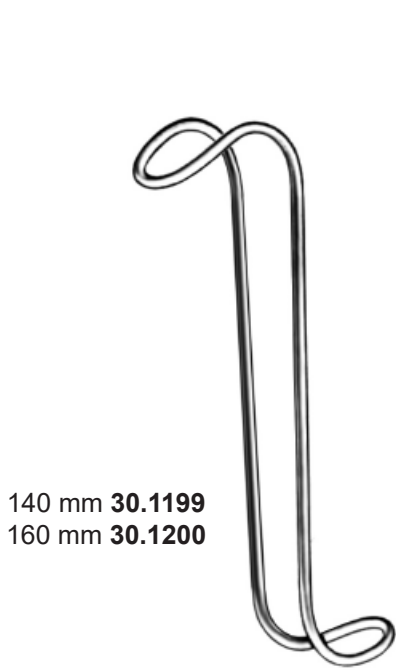

140 mm **30.1199**
160 mm **30.1200**

Collin- Hartmann
Komplet • Set • Набор **30.1198**



33x29 mm
29x26 mm
24x20 mm

1. 140 mm **30.1202**
2. 150 mm **30.1203**
3. 170 mm **30.1204**

30x28 mm
36x36 mm
38x43 mm

Roux
Komplet • Set • Набор **30.1201**

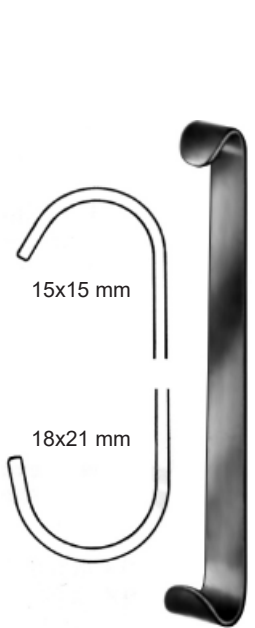

15x15 mm
18x21 mm

Baby-Roux
30.1205
130 mm



Mini-Roux
30.1206
140 mm



37x40 mm
30x31 mm

Goelet
30.1207
190 mm

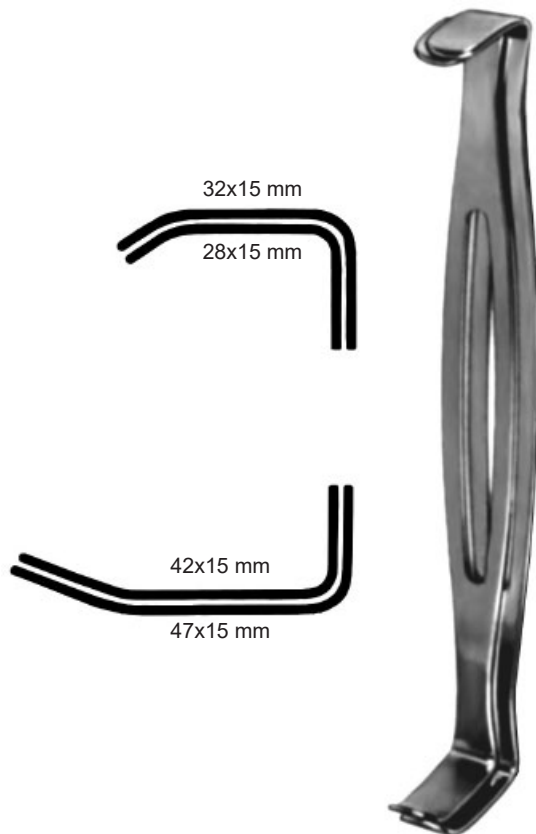

Parker-Langenbeck (US-Army)
30.1208
Komplet • Set • Набор 210 mm

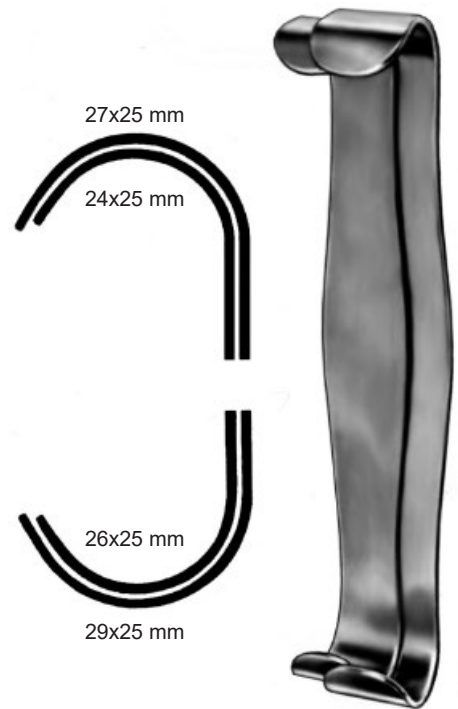

Parker
30.1209
Komplet • Set • Набор 180 mm



Parker
30.1210
Komplet • Set • Набор 135 mm



Parker-Mott
30.1211
Komplet • Set • Набор 160 mm

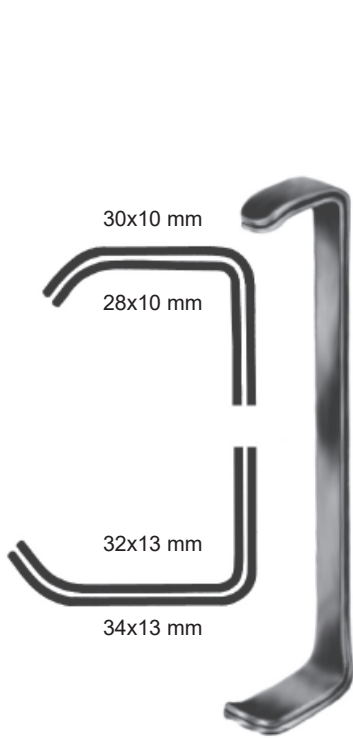

Farabeuf 30.1212
Komplet • Set • Набор
120 mm

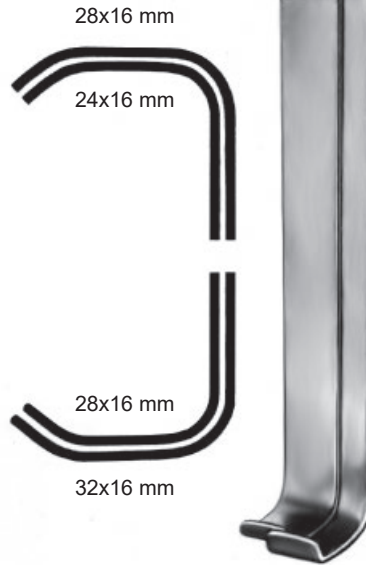

Farabeuf 30.1213
Komplet • Set • Набор
150 mm



30.1214
175 mm

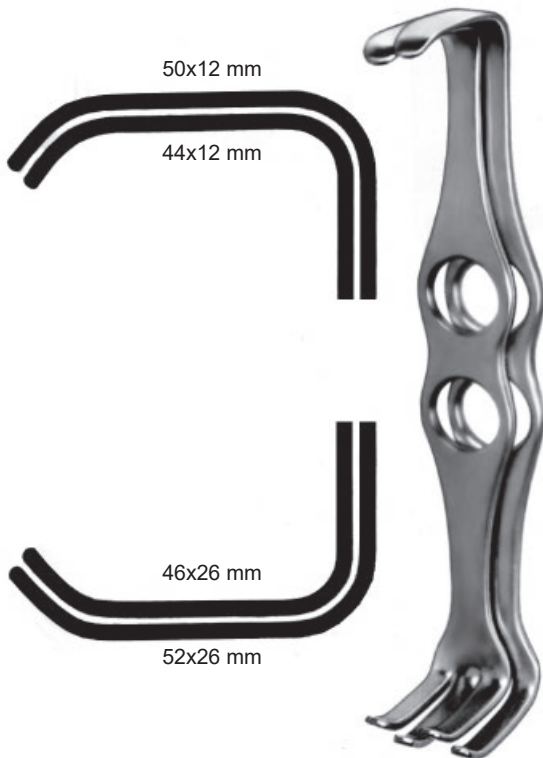

Mathieu 30.1215
Komplet • Set • Набор
200 mm

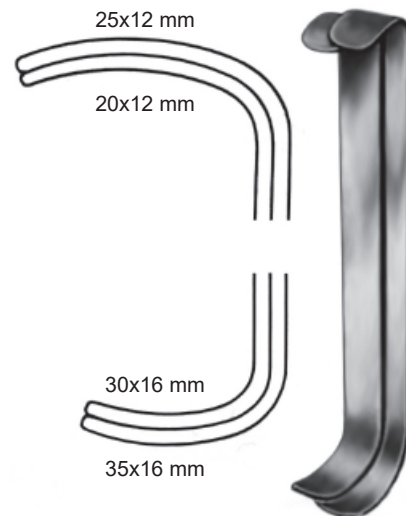

Collin 30.1216
Komplet • Set • Набор
150 mm



тупу
blunt
тупой



30.1217



30.1218



30.1219



30.1220

ostrý
sharp
острый



30.1221



30.1222



30.1223



30.1224

Murphy
195 mm



36x30 mm

30.1226



36x60 mm

Ollier
30.1227
225 mm



26x40 mm

30.1228



ostrý
sharp
острый

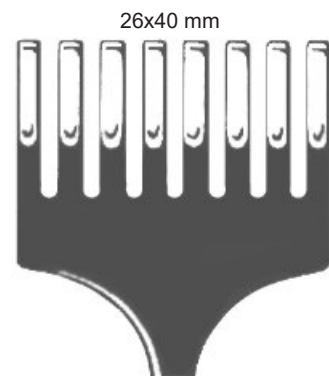

26x40 mm

30.1229

тупу
blunt
тупой

Körte
235 mm

40x40 mm



30.1234

45x50 mm



30.1235

50x60 mm



30.1236

70x70 mm



30.1237

25x40 mm



Israel
250 mm

46x55 mm



Körte
30.1239
230 mm

33x20 mm



Wassmund
30.1238
205 mm



Körte-Wagner
30.1240
280 mm

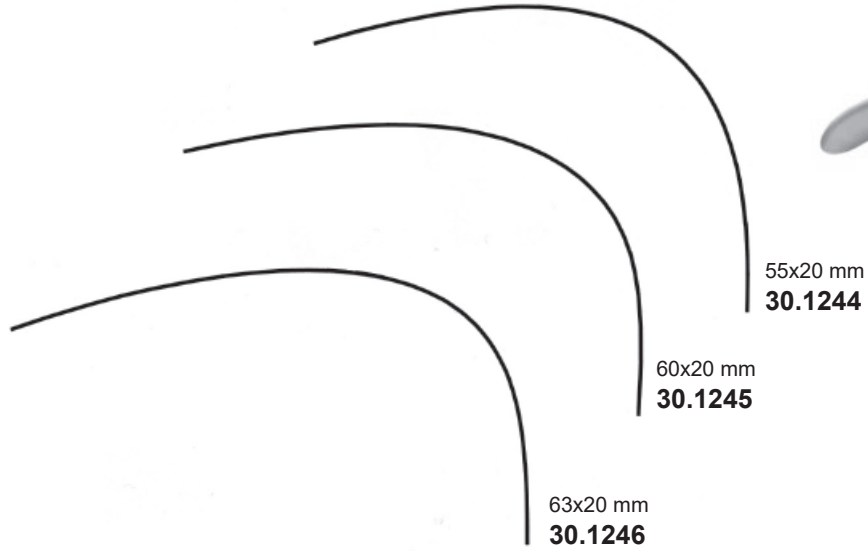

Langenbeck
210 mm

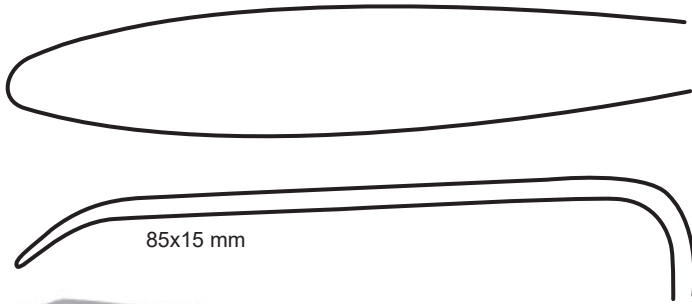

Langenbeck
30.1243
225 mm

30x11 mm
30.1247

30x14 mm
30.1248

30x16 mm
30.1249

40x11 mm
30.1250



Langenbeck
220 mm

30x11 mm
30.1251

30x14 mm
30.1252

33x14 mm
30.1253

30x16 mm
30.1254

40x11 mm
30.1255

42x13 mm
30.1256

50x11 mm
30.1257



Langenbeck
210 mm

35x7 mm
30.1258

35x10 mm
30.1259

35x15 mm
30.1260

60x20 mm
30.1261



Langenbeck
210 mm

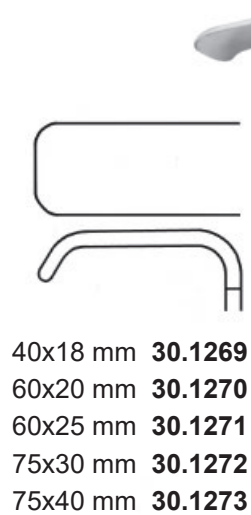
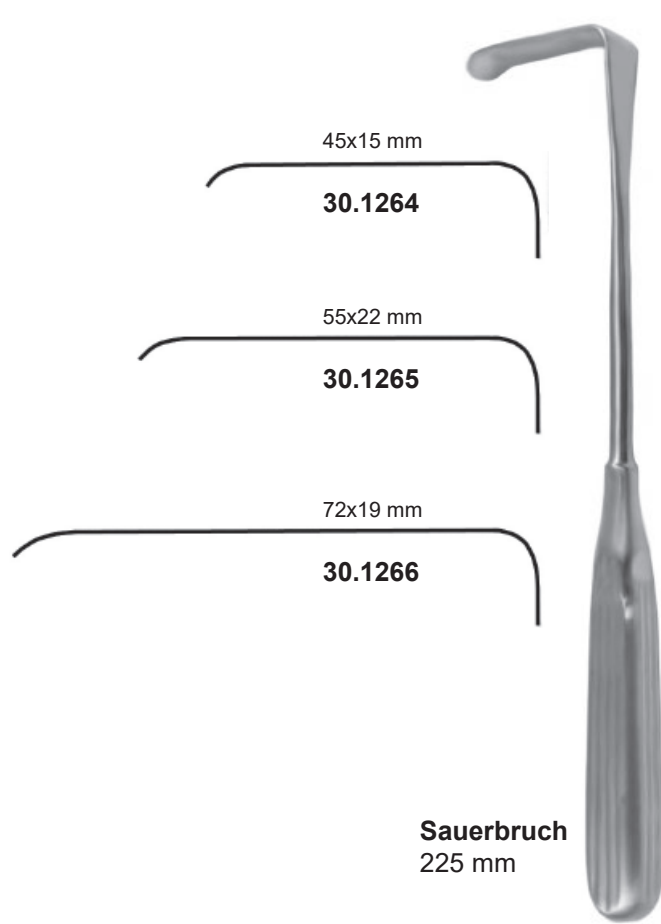

Kocher
215 mm

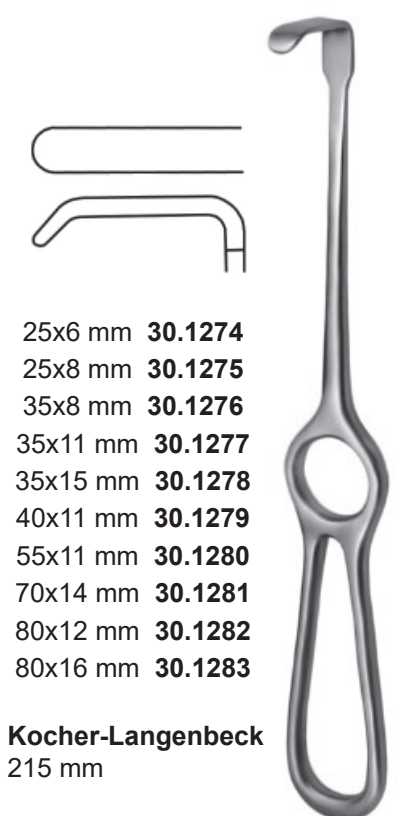

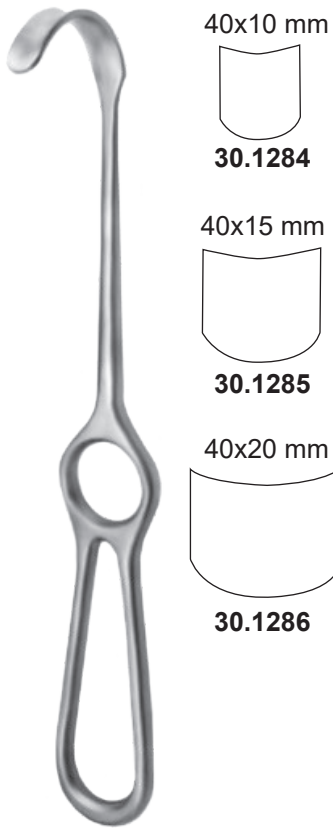

40x10 mm



30.1284

40x15 mm

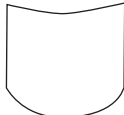

30.1285

40x20 mm

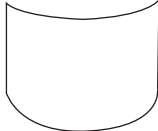

30.1286

Kocher
220 mm

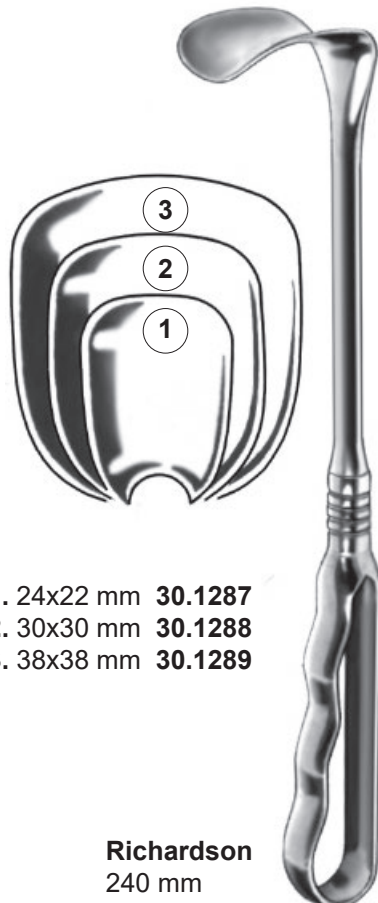

- 1. 24x22 mm **30.1287**
- 2. 30x30 mm **30.1288**
- 3. 38x38 mm **30.1289**

Richardson
240 mm



48x21 mm

Richardson
30.1290
240 mm



65x50 mm

Kelly
30.1291
260 mm

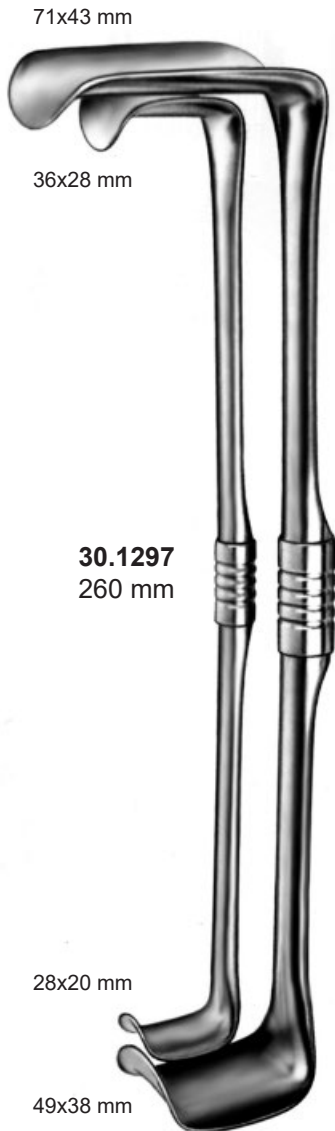
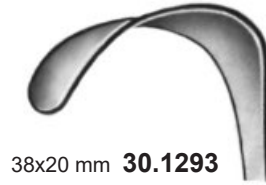

Richardson-Eastman
Komplet • Set • Набор
30.1296



Caspar
30.1299
215 mm

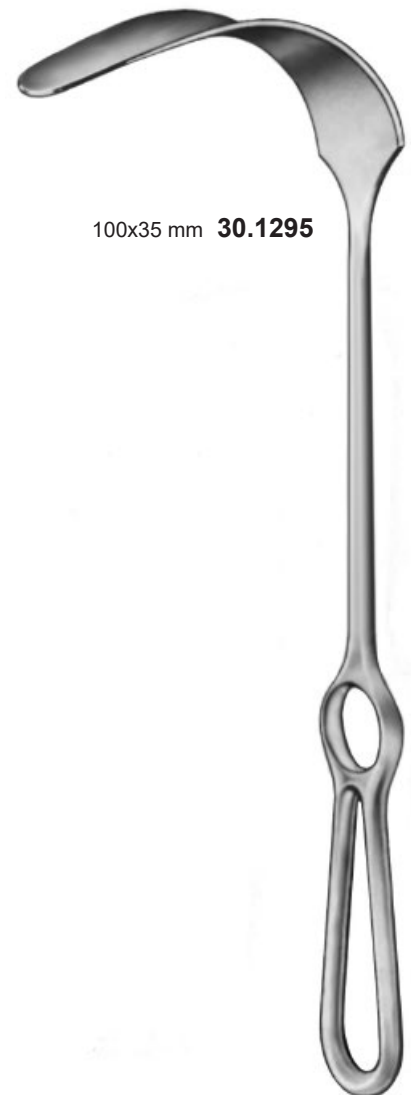

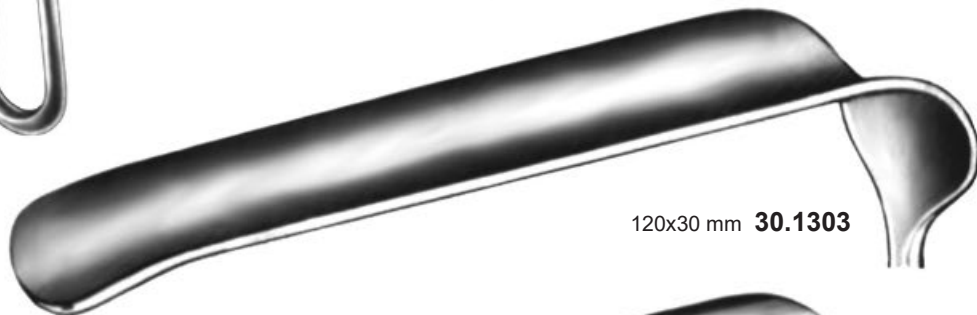
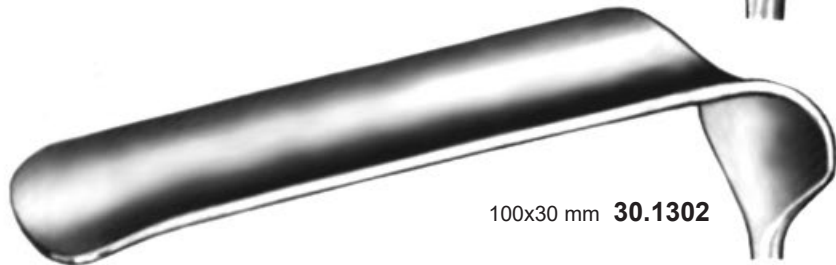
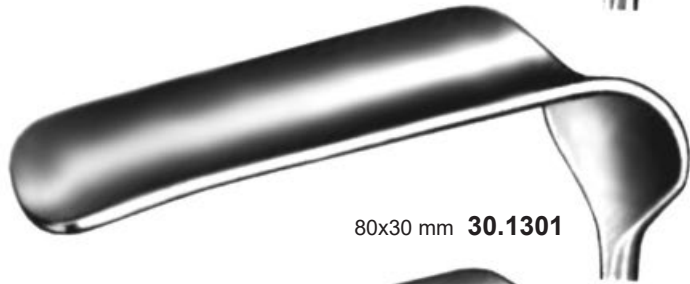



St. Marks

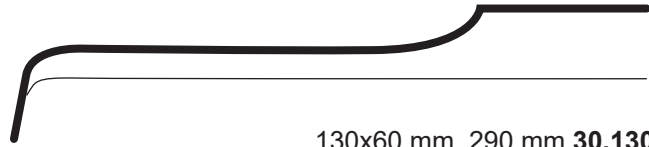

130x60 mm, 290 mm **30.1306**
180x60 mm, 325 mm **30.1307**



180x60 mm, 330 mm **30.1308**

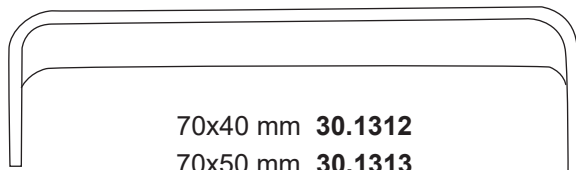

70x40 mm **30.1312**
70x50 mm **30.1313**
70x65 mm **30.1314**

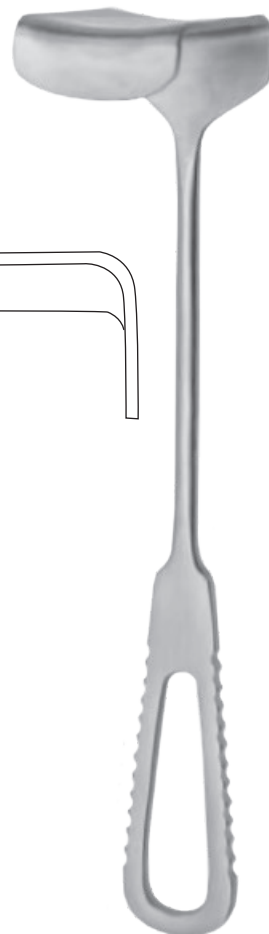

Morris
210 mm



Middeldorpf
275 mm



45x45 mm **30.1315**



45x50 mm **30.1316**



55x70 mm **30.1317**



Middeldorpf



14x17 mm
30.1321
215 mm



20x22 mm
30.1322
220 mm



26x30 mm
30.1323
235 mm

40x5 mm



Blount
30.1324
175 mm

51x19 mm



Richardson
30.1329
235 mm



Richardson
240 mm



25x19 mm
30.1330

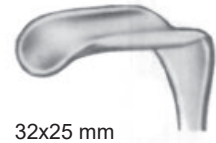

32x25 mm
30.1331



38x38 mm
30.1332



64x51 mm
30.1334

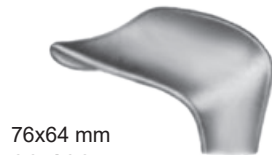

76x64 mm
30.1335



89x76 mm
30.1336



51x38 mm
30.1015

Kelly
250 mm

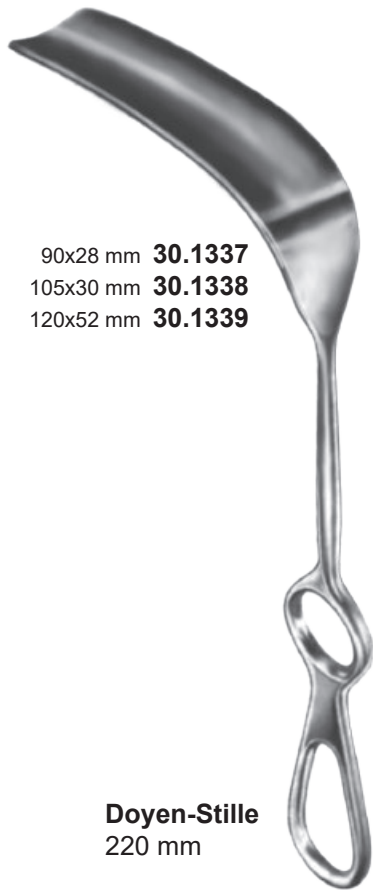

90x28 mm **30.1337**
105x30 mm **30.1338**
120x52 mm **30.1339**

Doyen-Stille
220 mm

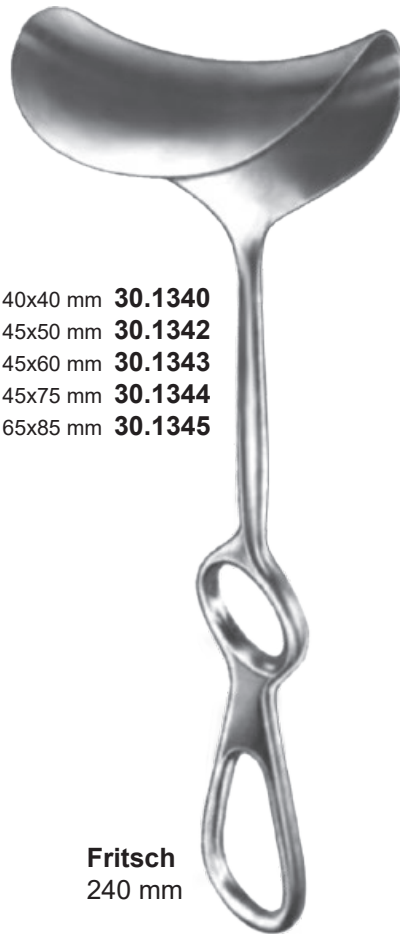

40x40 mm **30.1340**
45x50 mm **30.1342**
45x60 mm **30.1343**
45x75 mm **30.1344**
65x85 mm **30.1345**

Fritsch
240 mm

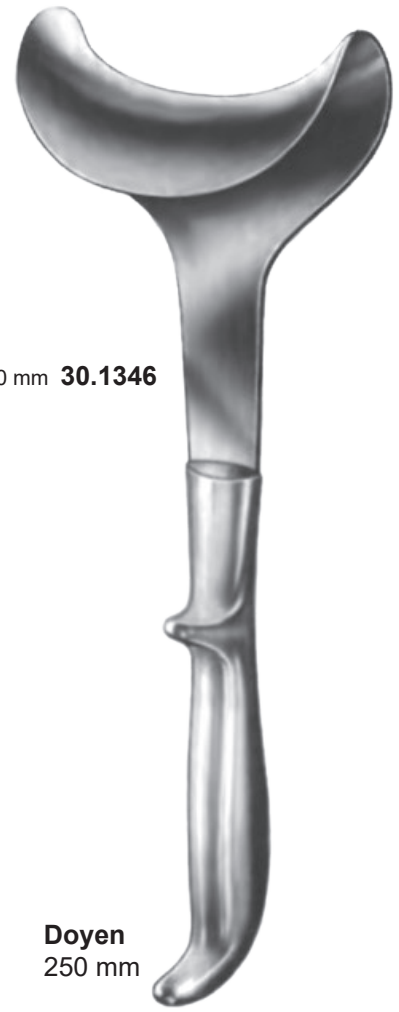

53x80 mm **30.1346**

Doyen
250 mm



64x60 mm **30.1348**

Tuffier
230 mm

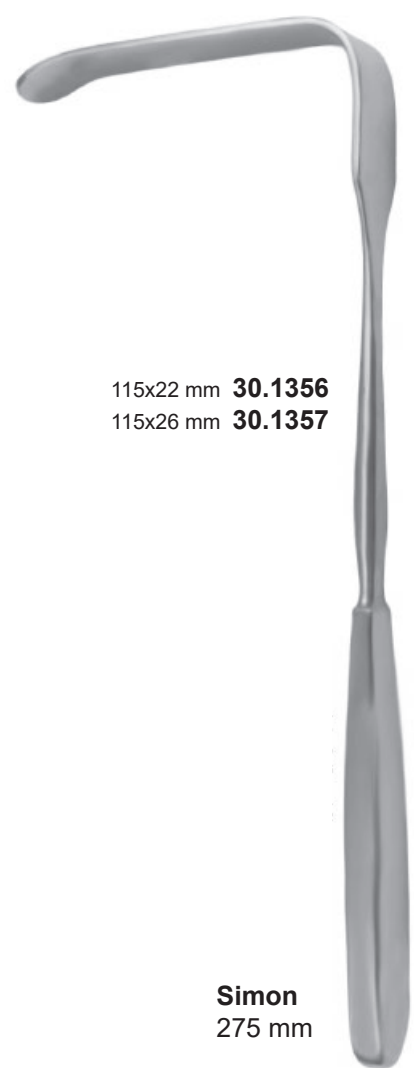

95x20 mm



Modell Tübingen

30.1358
265 mm

105x27 mm

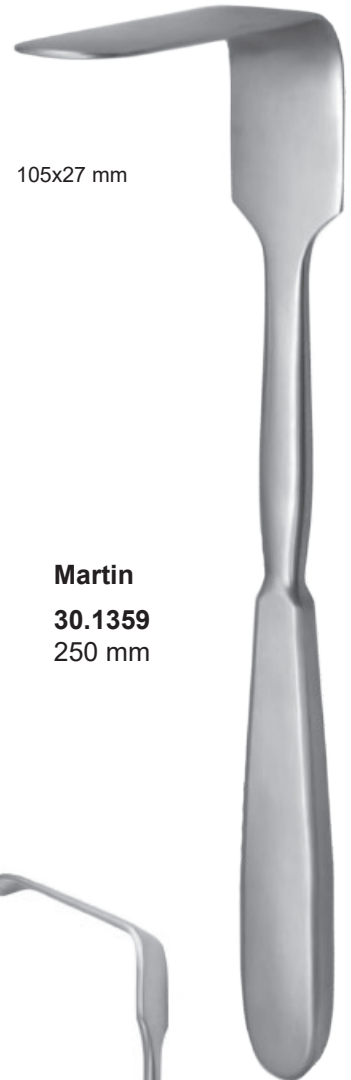

Martin

30.1359
250 mm

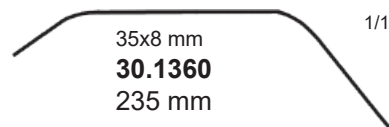

35x8 mm
30.1360
235 mm

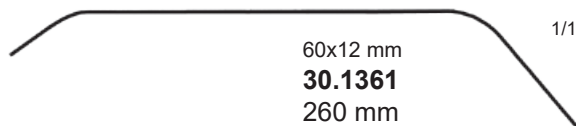

60x12 mm
30.1361
260 mm

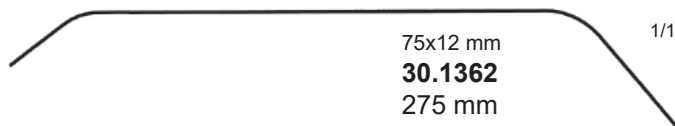

75x12 mm
30.1362
275 mm



120x12 mm
30.1363
290 mm



Zenker

180x30 mm **30.1364**

160x30 mm **30.1365**

140x30 mm **30.1366**

130x30 mm **30.1367**

120x25 mm **30.1368**

100x25 mm **30.1369**

80x20 mm **30.1370**



Brunner
250 mm

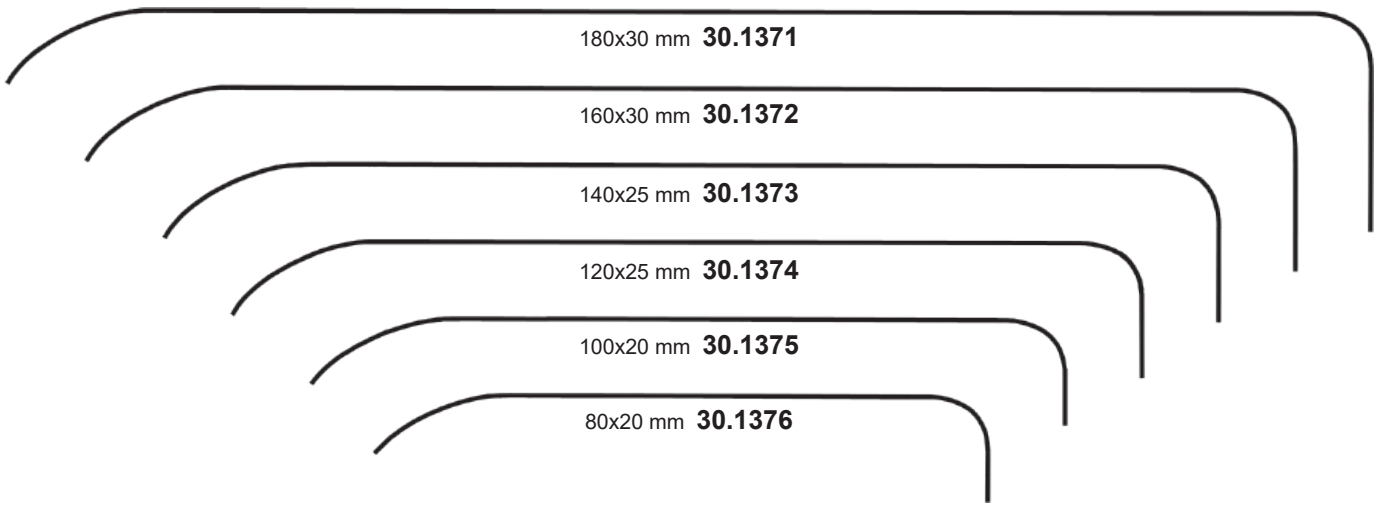

Brunner
250 mm



Deaver
30.1377
180 mm

Deaver
30.1378
215 mm

Deaver
30.1379
230 mm

Deaver
30.1380
300 mm

Deaver
30.1381
330 mm

Deaver
30.1382
360 mm

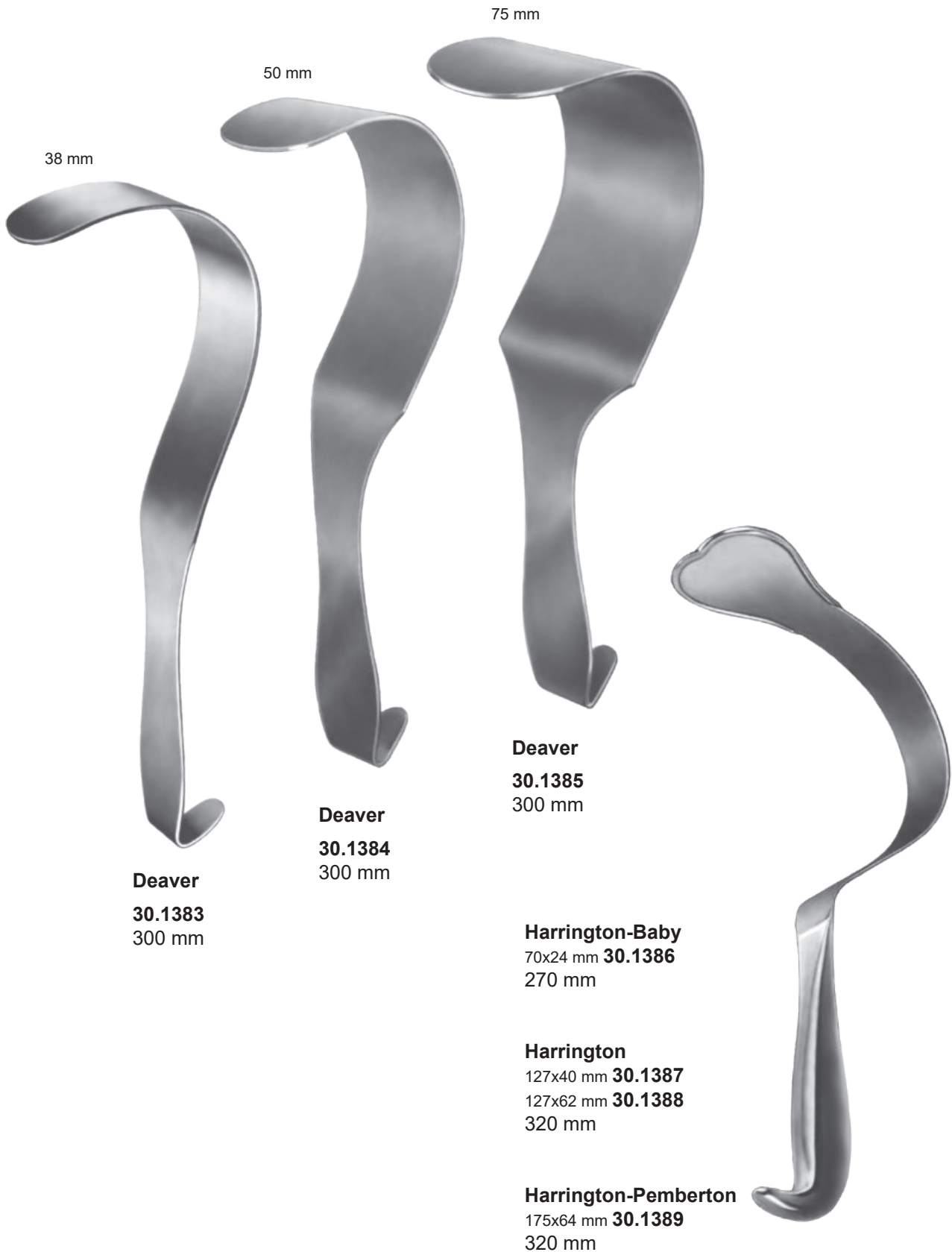

38 mm

50 mm

75 mm

Deaver
30.1383
300 mm

Deaver
30.1384
300 mm

Deaver
30.1385
300 mm

Harrington-Baby
70x24 mm **30.1386**
270 mm

Harrington
127x40 mm **30.1387**
127x62 mm **30.1388**
320 mm

Harrington-Pemberton
175x64 mm **30.1389**
320 mm



85x35 mm **30.1390**
120x50 mm **30.1391**
155x50 mm **30.1392**

Mikulicz
260 mm

90x50mm **30.1393**

Mikulicz
260 mm

160x38mm **30.1394**
160x57mm **30.1395**
190x38mm **30.1396**
190x57mm **30.1397**

Kelly
270 mm



115x65 mm **30.1402**



115x38 mm **30.1403**



82x22 mm **30.1404**

Coryllos
240 mm



125x37 mm

1/1



45x25 mm
30.1409

73x28 mm
30.1410

82x28 mm
30.1411

Heaney
270 mm

Sauerbruch
30.1405
250 mm



75x50 mm

Davidson
30.1412
160 mm



Cooley
30.1414
215 mm



75x90 mm

Davidson
30.1413
160 mm

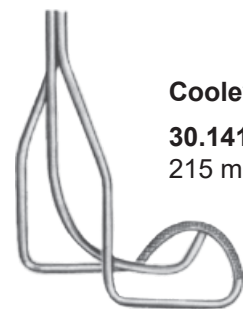

Cooley
30.1415
215 mm

ząbkowany
serrated
зубчатый

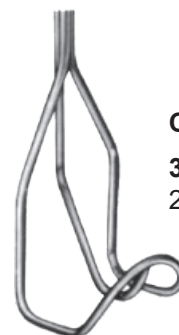

Cooley
30.1416
230 mm

90x50 mm **30.1417**



75x25 mm **30.1418**



50x16 mm **30.1419**



Meyerding
225 mm

elastyczne • flexible • эластичный



330 mm 30 mm **30.1533**
 330 mm 40 mm **30.1534**
 330 mm 50 mm **30.1535**

elastyczne • flexible • эластичный



Tuffier 200 mm 17x25 mm **30.1536**

elastyczne • flexible • эластичный



200 mm	6mm	30.1537	200 mm	17mm	30.1540
200 mm	9mm	30.1538	200 mm	20mm	30.1541
200 mm	12mm	30.1539	200 mm	25mm	30.1542

elastyczne • flexible • эластичный



Haberer 280 mm 25x30 mm **30.1543**
 300 mm 37x45 mm **30.1544**



Reverdin 285 mm 65x45 mm **30.1545**

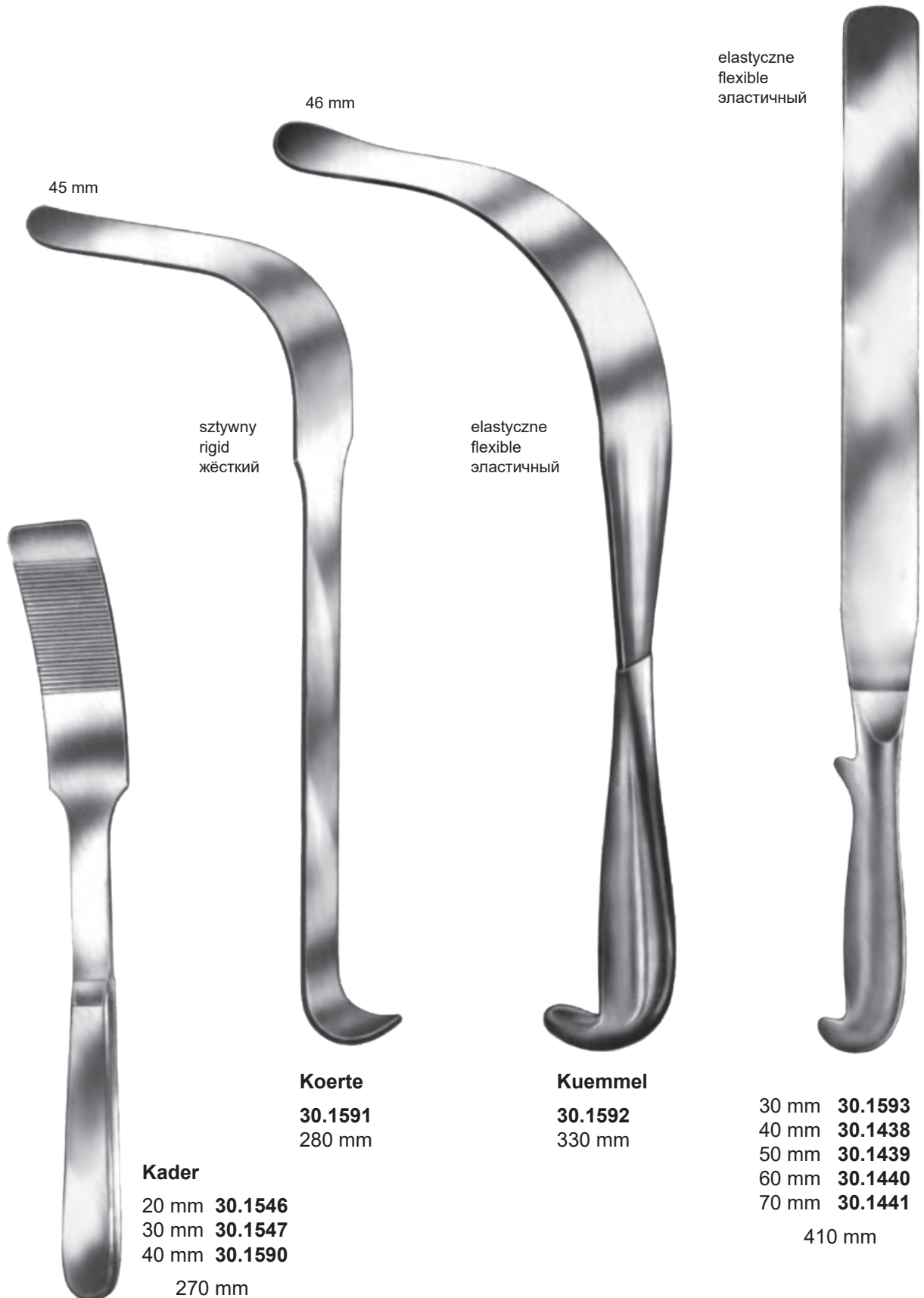



30.1442
ostry
sharp
острый

30.1443
tępy
blunt
тупой

Finsen
50 mm



30.1444
ostry
sharp
острый

30.1445
tępy
blunt
тупой

Finsen
70 mm



30.1446
ostry
sharp
острый

30.1447
tępy
blunt
тупой



Alm

ostry sharp острый	tępy blunt тупой
--------------------------	------------------------

70 mm	30.1450	30.1452
100 mm	30.1451	30.1453



30.1454
ostry
sharp
острый

30.1455
tępy
blunt
тупой

Holtzheimer
100 mm

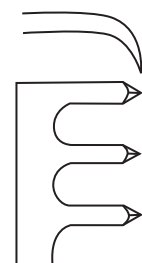

30.1457
ostry
sharp
острый

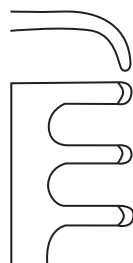

30.1456
tępy
blunt
тупой

Jansen
100 mm

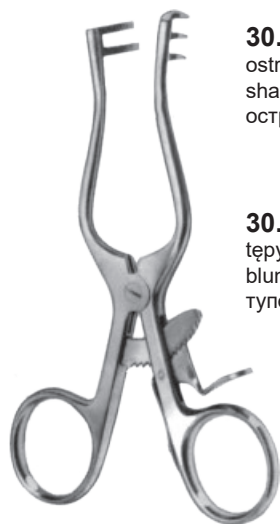

30.1458
ostry
sharp
острый

30.1459
tępy
blunt
тупой

Weitlaner-Loktite
105 mm



	ostry sharp острый	tępy blunt тупой
130 mm	30.1460	30.1461
165 mm	30.1462	30.1463
200 mm	30.1464	30.1465

Weitlaner-Loktite



30.1466
ostry
sharp
острый

30.1467
tępy
blunt
тупой

Weitlaner-Wullstein
130 mm

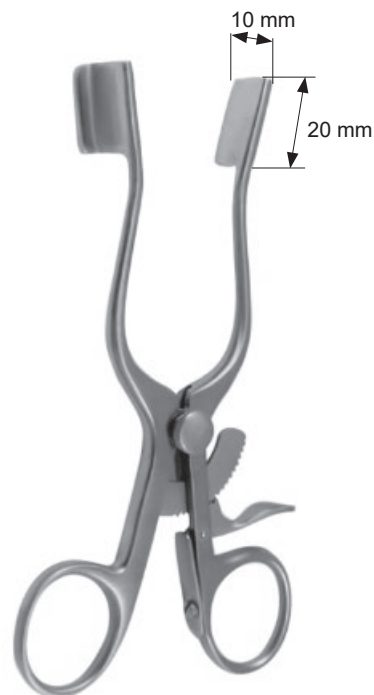

Weitlaner-Baby

30.1468
130 mm



30.1469
ostry
sharp
острый

30.1470
tępy
blunt
тупой

Scalp Contour
140mm



	ostry sharp острый	tępy blunt тупой
130 mm	30.1471	30.1472
165 mm	30.1473	30.1474
200 mm	30.1475	30.1476
250 mm	30.1477	30.1478

Cone

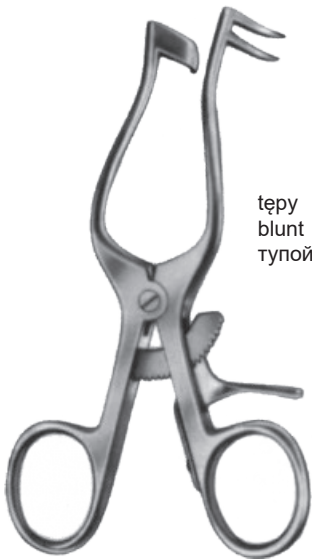

tępy
blunt
тупой

Plester
30.1479
110mm

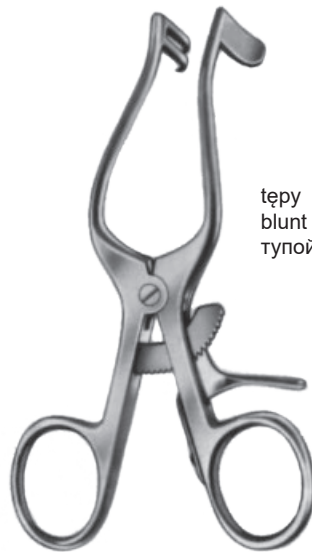

tępy
blunt
тупой

Plester
30.1548
110mm



30.1480
ostry
sharp
острый

30.1481
tępy
blunt
тупой

Plester
130mm



Milligan
130 mm

30.1482.000

tępy
blunt
тупой

30.1482.100

ostry
sharp
острый



Tübinger Modell

30.1483
165 mm



Mollison
30.1484
155 mm



Adson-Baby
160 mm

30.1485

tępy
blunt
тупой

30.1486

ostry
sharp
острый



Beckmann
310 mm

30.1487
ostry
sharp
острый

30.1488
tępy
blunt
тупой

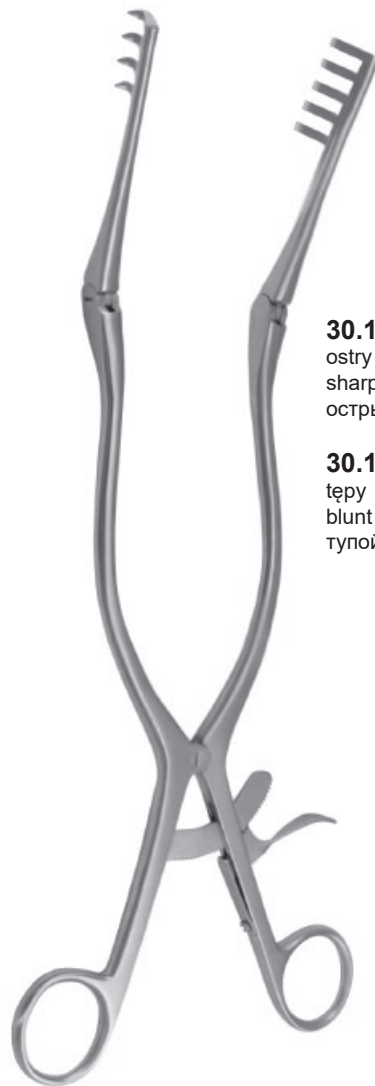

Adson
320 mm

30.1489
ostry
sharp
острый

30.1490
tępy
blunt
тупой

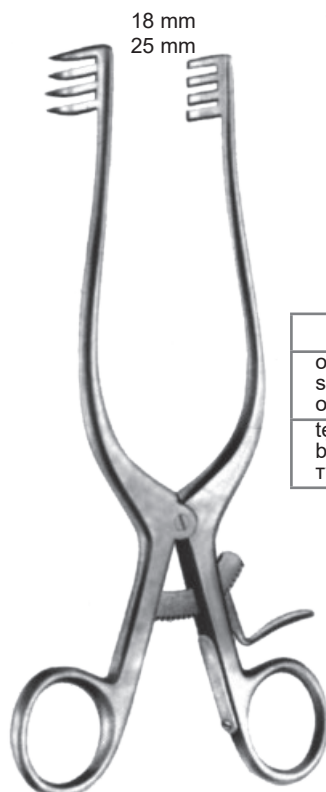

Adson
200 mm

18 mm
25 mm

	18 mm	25 mm
ostry sharp острый	30.1491	30.1491.025
tępy blunt тупой	30.1492	30.1492.025

25 mm
35 mm



Adson
265 mm

	25 mm	35 mm
ostry sharp острый	30.1493	30.1493.035
tępy blunt тупой	30.1494	30.1494.035

ramię lewe 35 mm, prawe 18 mm left arm 35 mm, right arm 18 mm	30.1495.100
--	--------------------

ramię lewe 18 mm, prawe 35 mm left arm 18 mm, right arm 35 mm	30.1495.200
--	--------------------

	35 mm
ostry sharp острый	30.1495
tępy blunt тупой	30.1496

35 mm



Adson
265 mm

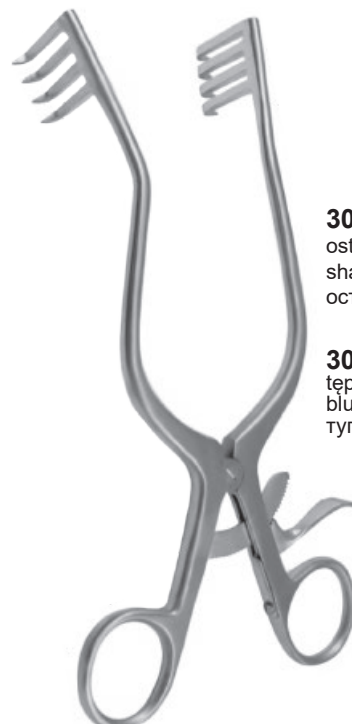

Anderson-Adson
195 mm

30.1497.000
ostry
sharp
острый

30.1497.100
tępy
blunt
тупой

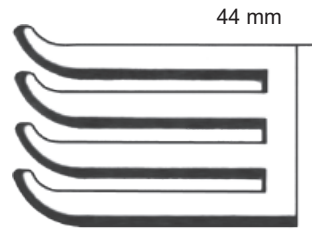

44 mm

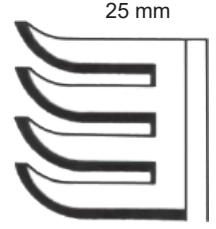

25 mm

30.1499

ostry
sharp
острый

30.1500

tępy
blunt
тупой

30.1501

ostry
sharp
острый

30.1502

tępy
blunt
тупой



Harvey-Jackson

40.6792
280 mm

ostry
sharp
острый

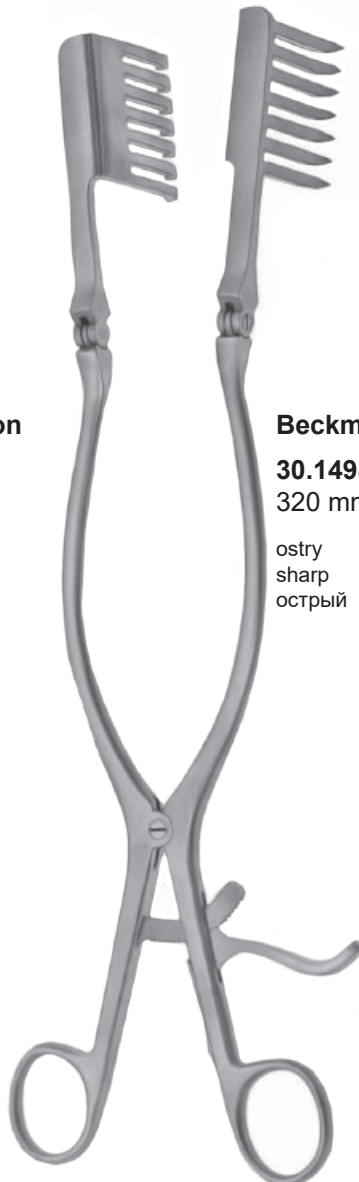

Beckmann-Eaton

30.1498
320 mm

ostry
sharp
острый

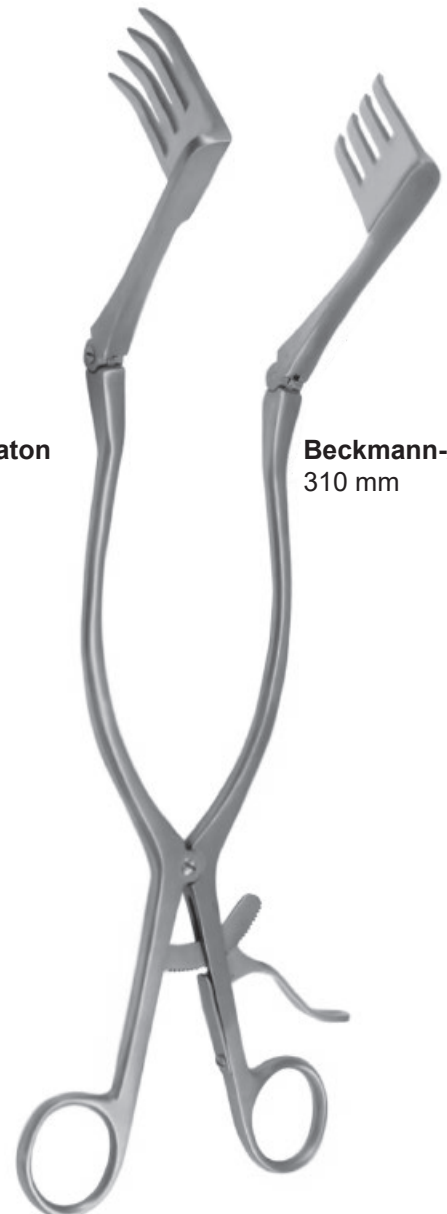

Beckmann-Adson

310 mm

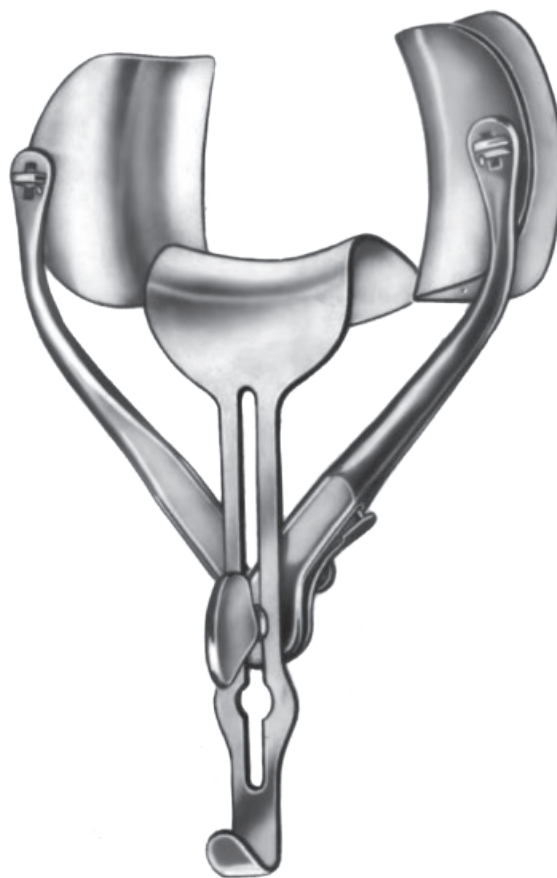

Ricard	Rozchylenie Spread Раскрытие	Łyżki boczne Lateral blades Боковые ложки	Łyżka środkowa Center blade Серединная ложка
30.1503	280 mm	72x85 mm	80x90 mm
30.1504	300 mm	60x80 mm	55x70 mm



Holzbach	Łyżki boczne Lateral blades Боковые ложки	Łyżka środkowa Center blade Серединная ложка
30.1507	62x80 mm	80x80 mm

Łyżki wymienne
Exchangeable blades
Заменяемые ложки



18x40 mm - **30.1511**
27x40 mm - **30.1512**
38x60 mm - **30.1513**
40x80 mm - **30.1514**
45x80 mm - **30.1515**
60x80 mm - **30.1516**



Collin-Ioktite
260 mm

	Rozchylenie Spread Раскрытие	Łyżki boczne Lateral blades Боковые ложки	Łyżka środkowa Center blade Серединная ложка
30.1508	160 mm	60x80 mm	60x75 mm

Collin-Ioktite

260 mm

	Rozchylenie Spread Раскрытие	Łyżki boczne Lateral blades Боковые ложки	Łyżka środkowa Center blade Серединная ложка
30.1509	100 mm	38x60 mm	38x55 mm
30.1510	100 mm	38x80 mm	50x75 mm



Komplet z 2 parami łyżek
 Set with 2 pairs of blades
 Комплект с двумя парами ложек

Baby-Collin	Rozchylenie Spread Раскрытие	Łyżki boczne Lateral blades Боковые ложки
200 mm		
30.1517	80 mm	27x40 mm 18x40 mm



Collin	Rozchylenie Spread Раскрытие	Łyżki boczne Lateral blades Боковые ложки
240 mm		
30.1518	100 mm	38x60 mm



DeBakey

30.1519 100 mm
30.1520 145 mm



Gelpi-Loktite

30.1521 90 mm
30.1522 115 mm



Gelpi-Loktite

30.1523 140 mm
30.1524 180 mm



Gelpi-Loktite

30.1525
180 mm



Rigby
30.1526
 180 mm

Rozchylenie
 Spread
 Раскрытие
 100 mm

Łyżki boczne
 Lateral blades
 Боковые ложки
 70x16 mm



Meyerding
 190 mm

Łyżki boczne
 Lateral blades
 Боковые ложки

30.1527 25x30 mm
30.1528 25x55 mm
30.1529 25x60 mm
30.1530 20x60 mm

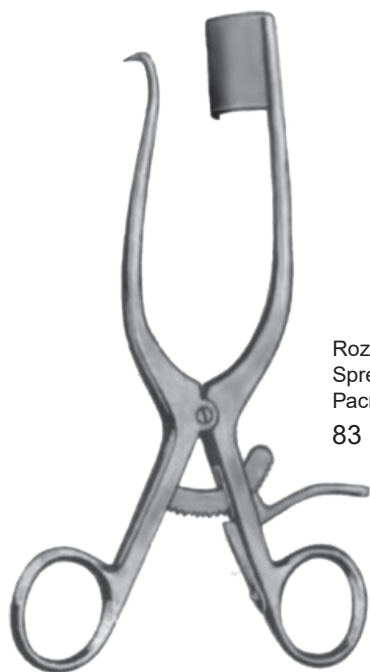

Markham-Meyerding
30.1531
 180 mm

Rozchylenie
 Spread
 Раскрытие
 83 mm

Łyżka prawa
 Right blade
 Ложка правая
 45x25 mm

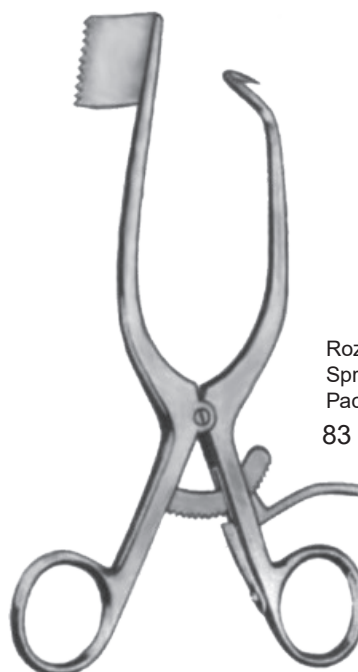

Markham-Meyerding
30.1532
 180 mm

Rozchylenie
 Spread
 Раскрытие
 83 mm

Łyżka lewa
 Left blade
 Ложка левая
 45x25 mm



Gosset
Rozchylenie
Spread
Раскрытие
30.1550
100 mm
Łyżki boczne
Lateral blades
Боковые ложки
30x40 mm



Gosset
Rozchylenie
Spread
Раскрытие
30.1551
100 mm
Łyżki boczne
Lateral blades
Боковые ложки
30x40 mm



Gosset
Rozchylenie
Spread
Раскрытие
30.1552
160 mm
Łyżki boczne
Lateral blades
Боковые ложки
35x63 mm
Łyżka środkowa
Center blade
Серединная ложка
56x60 mm

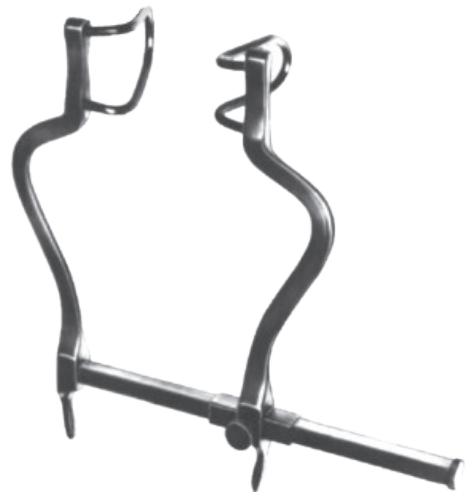

Gosset
Rozchylenie
Spread
Раскрытие
30.1553
140 mm
Łyżki boczne
Lateral blades
Боковые ложки
35x63 mm

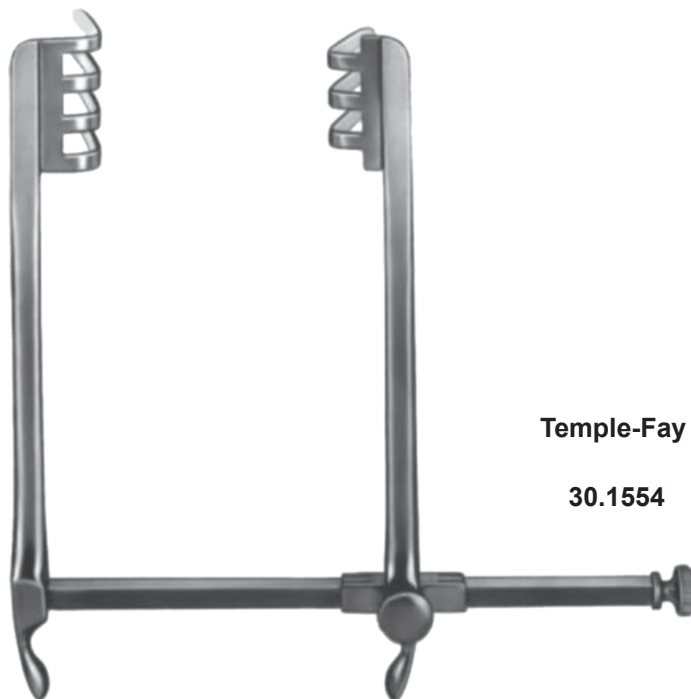

Temple-Fay

Rozchylenie
Spread
Раскрытие

30.1554

120 mm

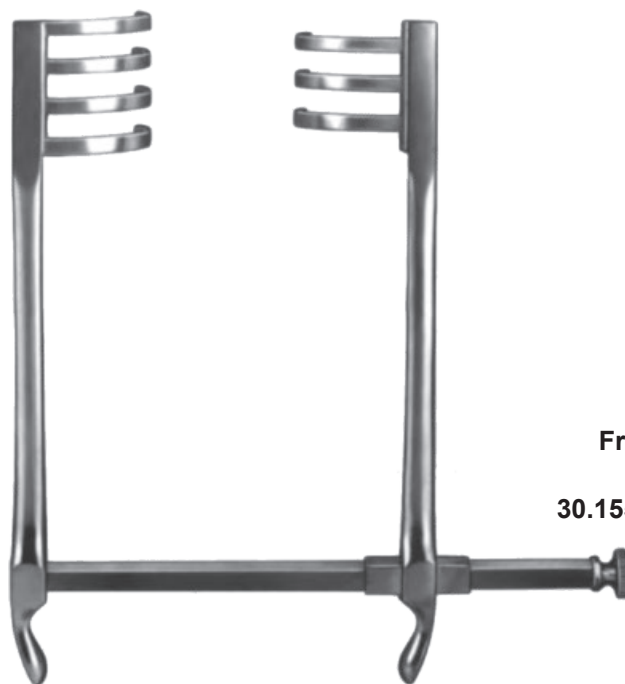

Frazier

Rozchylenie
Spread
Раскрытие

30.1555

85 mm



Balfour-Baby

Rozchylenie	Łyżki boczne	Łyżka środkowa
Spread	Lateral blades	Center blade
Раскрытие	Боковые ложки	Серединная ложка

30.1556	90 mm	26x38 mm	25x23 mm
----------------	-------	----------	----------



Balfour

Rozchylenie	Łyżki boczne	Łyżka środkowa
Spread	Lateral blades	Center blade
Раскрытие	Боковые ложки	Серединная ложка

30.1557	180 mm	35x70 mm	45x80 mm
----------------	--------	----------	----------

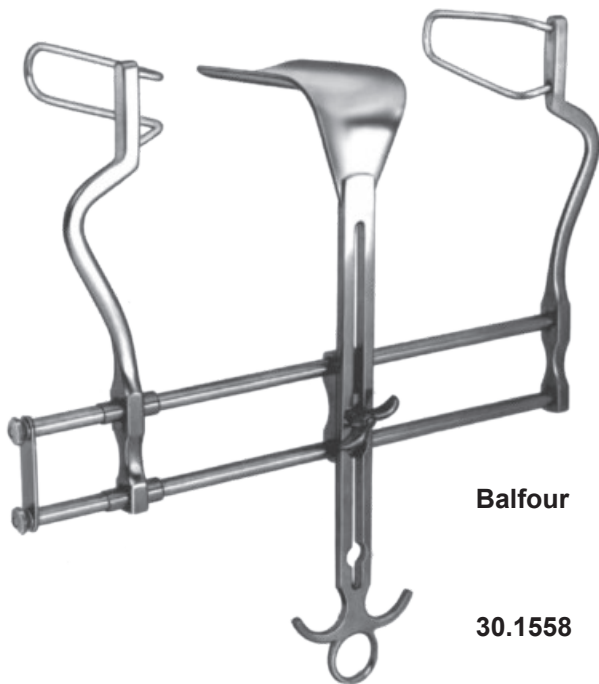

Balfour

Rozchylenie	Łyżki boczne	Łyżka środkowa
Spread	Lateral blades	Center blade
Раскрытие	Боковые ложки	Серединная ложка

30.1558	200 mm	35x100 mm	60x100 mm
----------------	--------	-----------	-----------



Balfour

30.1559

Rozchylenie
Spread
Раскрытие

250 mm

Łyżki boczne
Lateral blades
Боковые ложки

35x100 mm

Łyżka środkowa
Center blade
Серединная ложка

70x85 mm

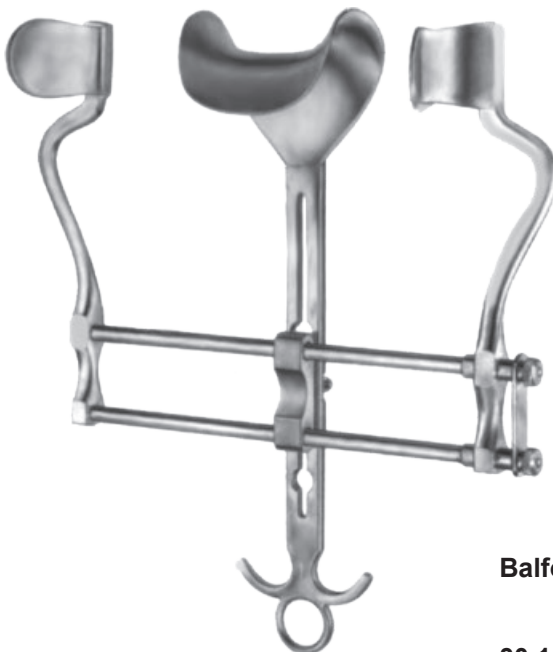

Balfour

30.1560

Rozchylenie
Spread
Раскрытие

180 mm

Łyżki boczne
Lateral blades
Боковые ложки

35x70 mm

Łyżka środkowa
Center blade
Серединная ложка

45x80 mm

Balfour

30.1561

30.1562

30.1563

Łyżka środkowa
Center blade
Серединная ложка

45x80 mm

70x85 mm

100x60 mm

300x300 mm

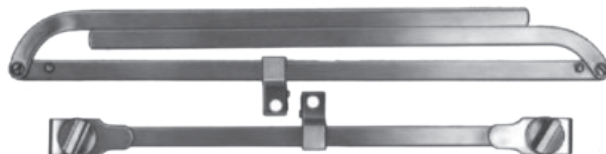

30.1564
 Składana rama
 Folding frame
 Складная рама

Нак
 Hook **30.1565**
 Ложка 38x60 mm

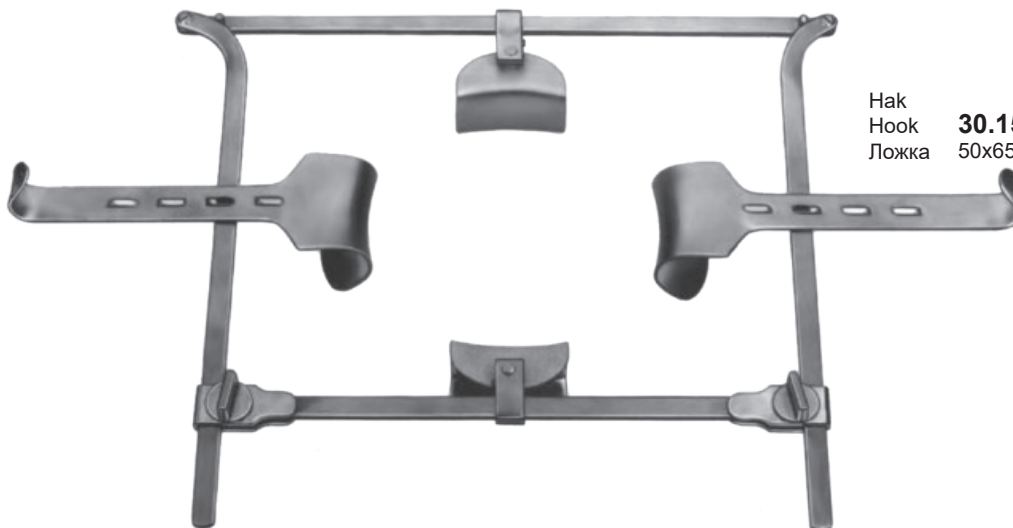

Нак
 Hook **30.1566**
 Ложка 50x65 mm

Нак
 Hook **30.1567**
 Ложка 45x80 mm



30.1568
 60x85 mm

Franz	30.1569	komplet z 4 hakami set with 4 hooks набор с 4 ложками	2x 50x65 mm 2x 38x60 mm
	30.1570	komplet z 8 hakami set with 8 hooks набор с 8 ложками	2x 50x65 mm 2x 38x60 mm 2x 45x80 mm 2x 60x85 mm

240x240 mm



30.1571
Sztwna rama
Fixed frame
Жёсткая рама

Kirschner

- 30.1572** 40x55 mm
- 30.1573** 50x65 mm
- 30.1574** 60x85 mm
- 30.1575** 78x65 mm
- 30.1576** 80x90 mm

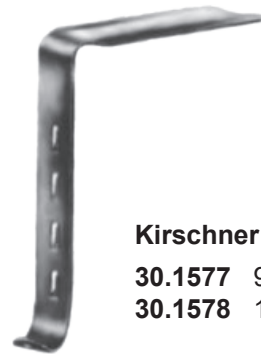

Kirschner

- 30.1577** 98x50 mm
- 30.1578** 105x35 mm



Kirschner	30.1579	komplet z 4 hakami set with 4 hooks набор с 4 ложками	2x 40x55 mm 2x 50x65 mm
------------------	----------------	---	----------------------------

175x150 mm

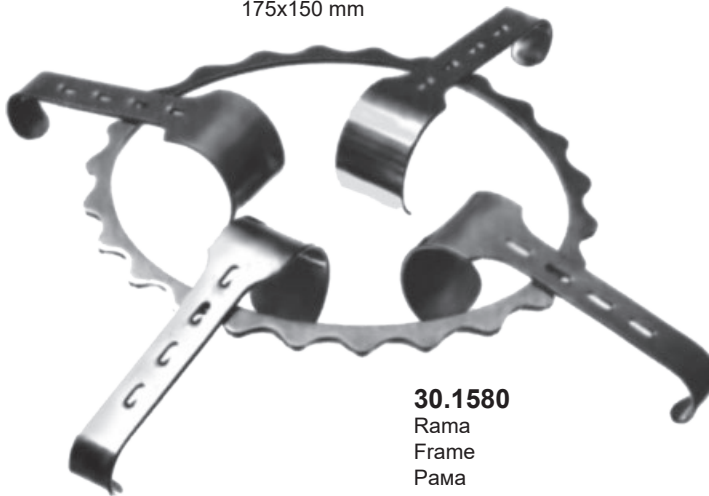

30.1580
Rama
Frame
Рама

Denis-Browne

Hak
Hook
Ложка

- 30.1581** 20x30 mm
- 30.1582** 20x40 mm
- 30.1583** 40x30 mm
- 30.1584** 40x40 mm

Denis-Browne	30.1585	komplet z 4 hakami complete with 4 hooks набор с 4 ложками	2x 40x30 mm 2x 40x40 mm
---------------------	----------------	--	----------------------------



Нак
 Hook
 Ложка
30.1587
 80x45 mm



Нак
 Hook
 Ложка
30.1588
 110x70 mm



30.1586
 Rama
 Frame
 Рама



O'Sullivan-O'Connor	30.1589	komplet z 3 hakami set with 3 hooks набор с 3 ложками	2x 80x45 mm 1x 110x70 mm
---------------------	----------------	---	-----------------------------

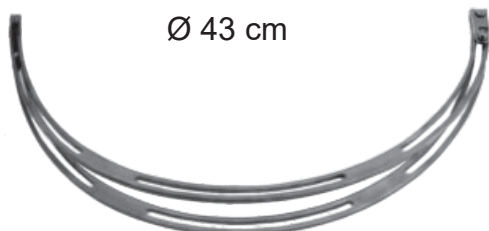

Ø 43 cm

30.1600.100

tylko rama • frame only • только рама

30.1600.001

śruba • screw • винт

30.1600.002

nakrętka • nut • гайка



Derom-Vandamme

30.1600.000

komplet • set • комплект

1x **30.1600.100**

12x **30.1600.001**

12x **30.1600.002**

3x **30.1600.200**

2x **30.1600.300**

2x **30.1600.400**

2x **30.1600.500**



30.1600.200

90x50 mm



30.1600.300

50x60 mm



30.1600.400

60x95 mm



30.1600.500

60x60 mm

CHM[®]

KLESZCZYKI DO UCHA EAR FORCEPS ЗАЖИМЫ ДЛЯ УХА.....	163
KLESZCZYKI DO NOSA NASAL CUTTING FORCEPS НОСОБЫЕ ЗАЖИМЫ.....	167
POZOSTAŁE KLESZCZYKI ENT OTHER ENT FORCEPS ДРУГИЕ ЗАЖИМЫ ДЛЯ ENT.....	175



CHM[®]



prosty • straight • прямой
80.0200



zakrzywiony w lewo • curved left • влево
80.0201



zakrzywiony w prawo • curved right • вправо
80.0202



zakrzywiony do góry • curved upwards • вверх
80.0203

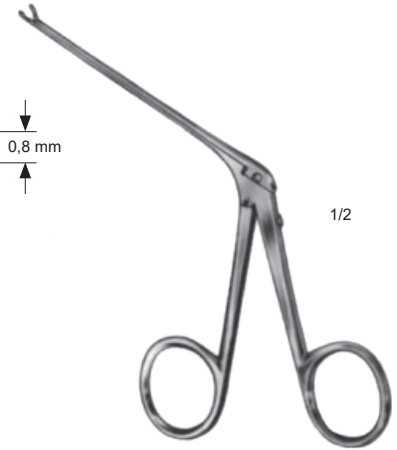
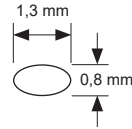

1/2

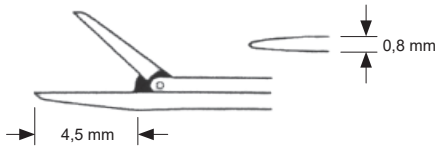

Mittelfein
L= 75 mm
80.0204

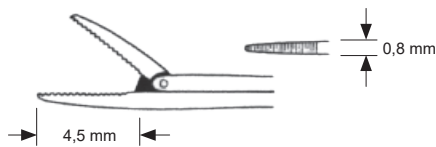

Mittelfein
L= 75 mm
80.0205

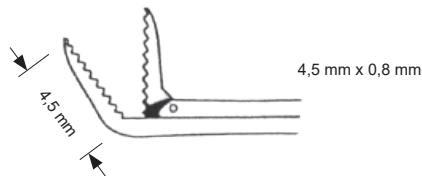

Mittelfein
L= 75 mm
80.0206

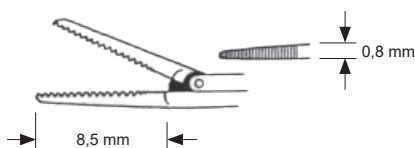

Bellucci
L= 80 mm
80.0207

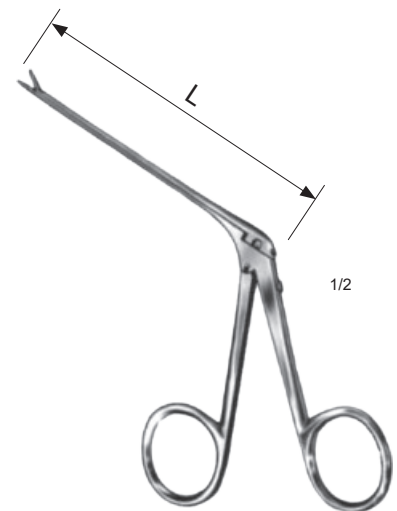

1/2

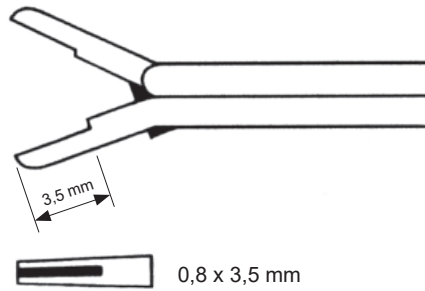

80.0208

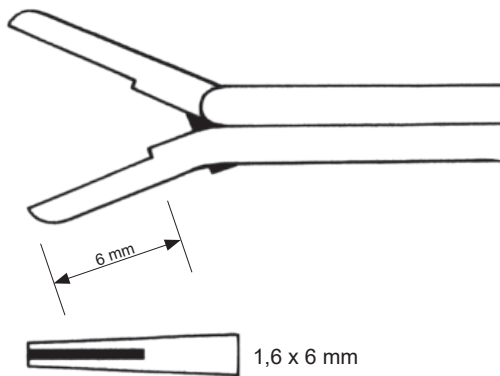

80.0209

zakrzywiony w prawo • curved rightwards • изогнутый вправо



80.0210

zakrzywiony w lewo • curved leftwards • изогнутый влево



80.0211



Mc Gee



Juers

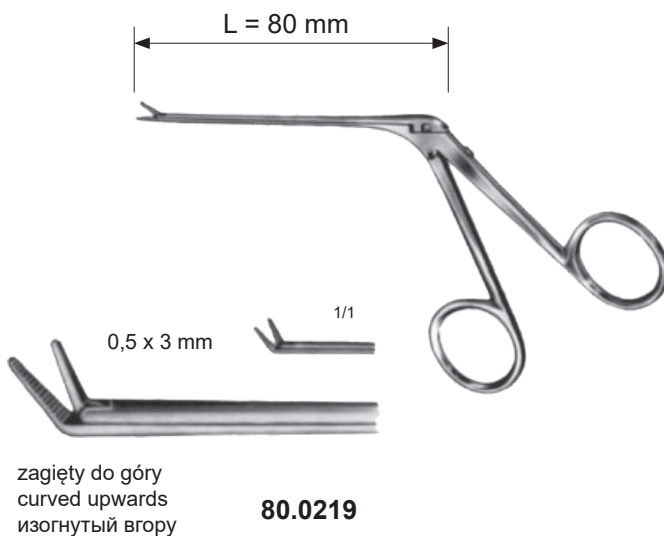
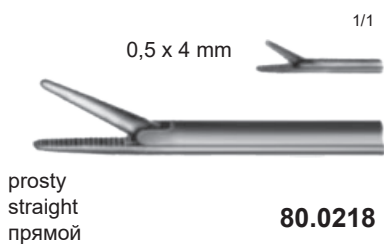
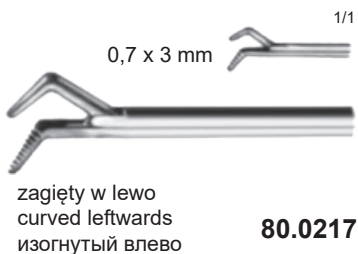
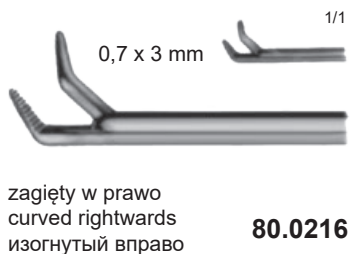
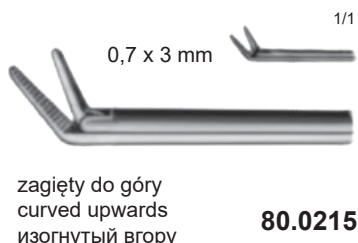
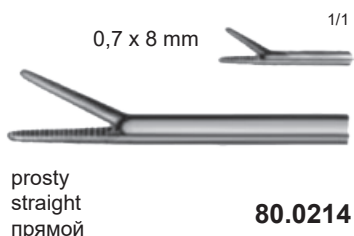
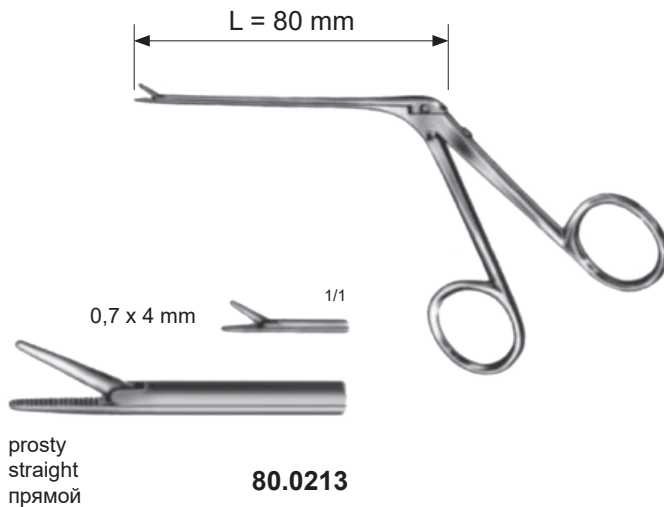
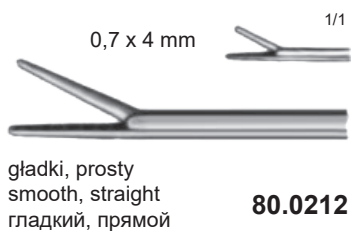

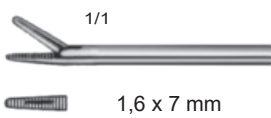
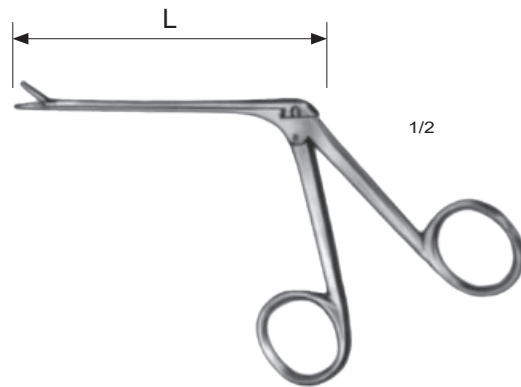

Hartmann
 L= 80 mm **80.0220**
 L= 140 mm **80.0221**
 L= 160 mm **80.0222**

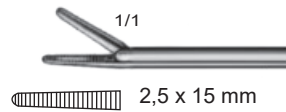

Hartmann-Noyes
 L= 90 mm **80.0237**

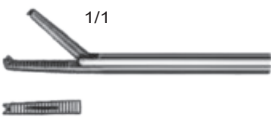

Hartmann
 L= 85 mm **80.0223**
 L= 140 mm **80.0224**

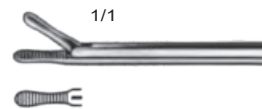

Duckbill
 L= 85 mm **80.0238**

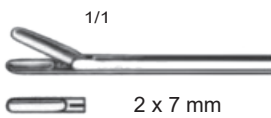

Hartmann
 L= 80 mm **80.0225**

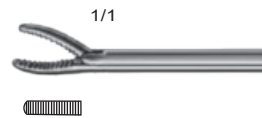

Weingärtner
 L= 85 mm **80.0239**

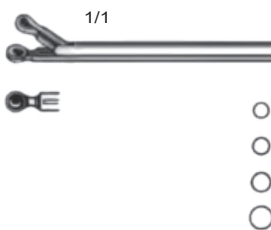

Hartmann
 L= 80 mm
 2,0 mm **80.0227**
 2,2 mm **80.0228**
 2,5 mm **80.0229**
 3,0 mm **80.0230**

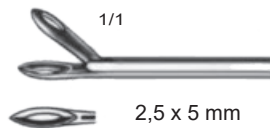

Strümpel
 L= 85 mm **80.0240**





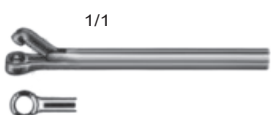

Hartmann
 L= 80 mm
 2,0 mm **80.0231**
 2,5 mm **80.0232**
 3,0 mm **80.0233**

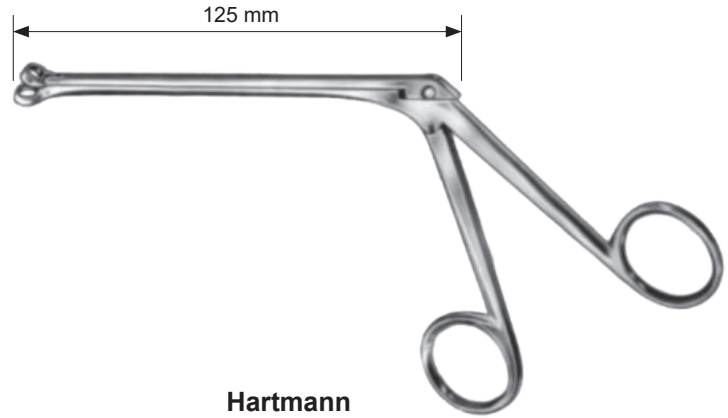

Hartmann-Hoffmann
 L= 85 mm **80.0234**



-  5 mm **80.0241**
-  7 mm **80.0242**
-  9 mm **80.0243**
-  11 mm **80.0244**



Grünwald

 **80.0245**

 **80.0246**

 **80.0247**



Grünwald

 **80.0248**



Myles

 **80.0252**

 **80.0253**

 **80.0254**

 **80.0255**



Schmeden

 **80.0249**

 **80.0250**

 **80.0251**





Struycken

 **80.0256**

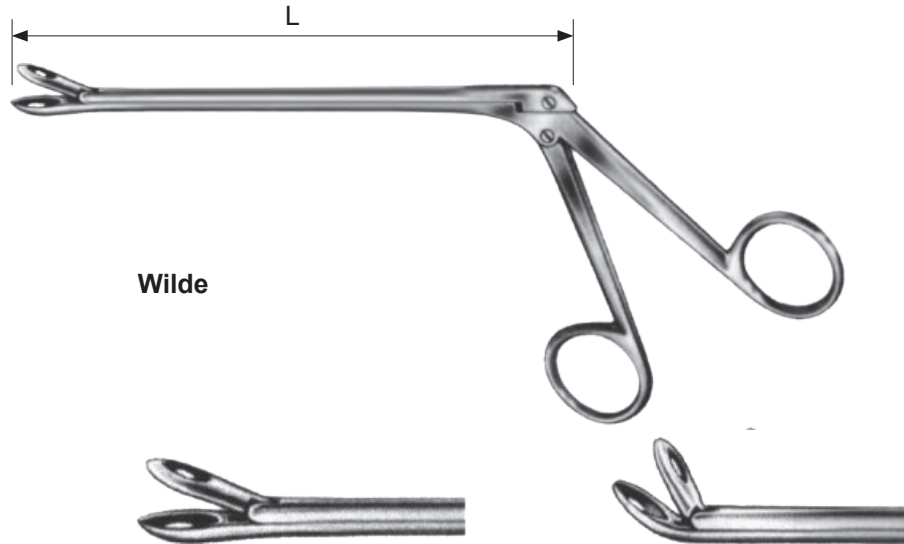
 **80.0257**

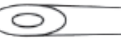

Wilde

		L = 130 mm	L = 170 mm	L = 130 mm	L = 170 mm	
1/1		3 x 8 mm	80.0258	80.0261	80.0264	80.0267
		4 x 10 mm	80.0259	80.0262	80.0265	80.0268
		5 x 12 mm	80.0260	80.0263	80.0266	80.0269



Watson-Williams
80.0270 L= 125 mm



Watson-Williams
80.0271 L= 125 mm



Watson-Williams
80.0272 L= 125 mm

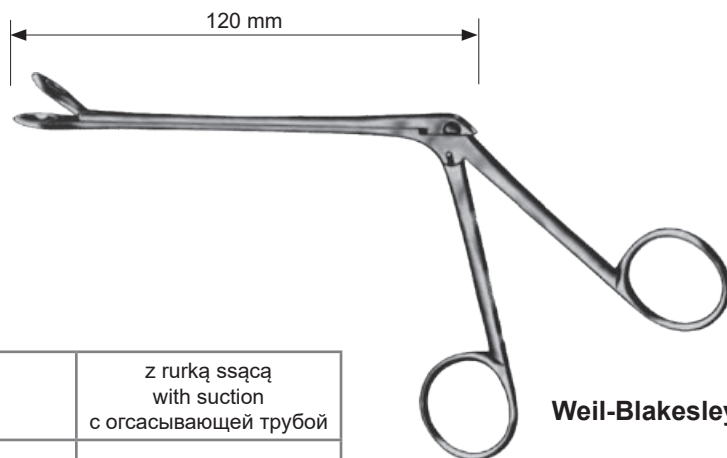

Weil-Blakesley

Prosty • Stright • Прямой

			standard	z rurką ssącą with suction с огсасывающей трубой
1/1		2,5 mm	80.0273	80.0288
		3,6 mm	80.0274	80.0289
		4,8 mm	80.0275	
		5,3 mm	80.0276	
		6,3 mm	80.0277	



Zakrzywiony 45° do góry • 45° curved upwards • Изогнутый 45° вверх

			standard	z rurką ssącą with suction с огсасывающей трубой
1/1		2,5 mm	80.0278	80.0293
		3,6 mm	80.0279	80.0294
		4,8 mm	80.0280	
		5,3 mm	80.0281	
		6,3 mm	80.0282	



Zakrzywiony 90° do góry • 90° curved upwards • Изогнутый 90° вверх

			standard
1/1		2,5 mm	80.0283
		3,6 mm	80.0284
		4,8 mm	80.0285
		5,3 mm	80.0286
		6,3 mm	80.0287



Takahashi

Prosty • Stright • Прямой



		standard	z rurką ssącą with suction с огсасывающей трубой
Fig. 1	2,5 mm	80.0303	80.0307
Fig. 2	4,0 mm	80.0304	80.0308



Zakrzywiony 45° do góry • 45° curved upwards • Изогнутый 45° вверх



		standard	z rurką ssącą with suction с огсасывающей трубой
Fig. 1	2,5 mm	80.0305	80.0309
Fig. 2	4,0 mm	80.0306	80.0310

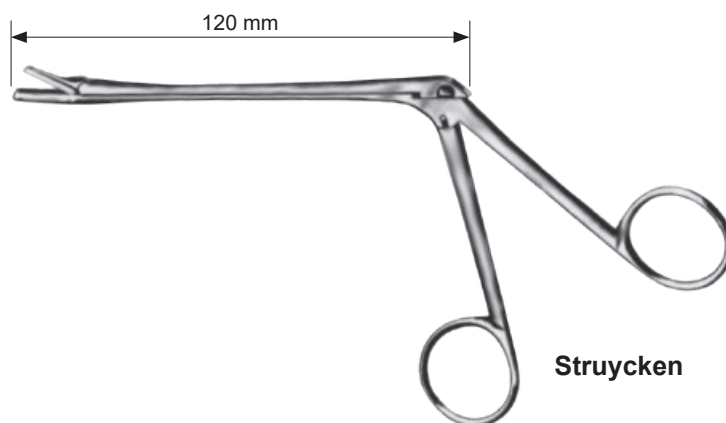
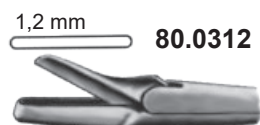
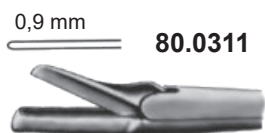

Struycken

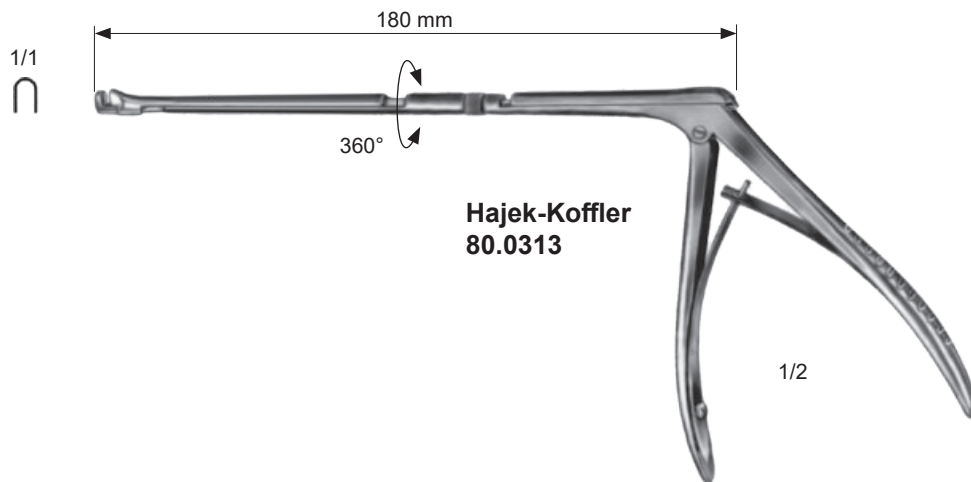

1/1



Fig. 1
80.0314



Fig. 2
80.0315



Fig. 3
80.0316



Fig. 4
80.0317

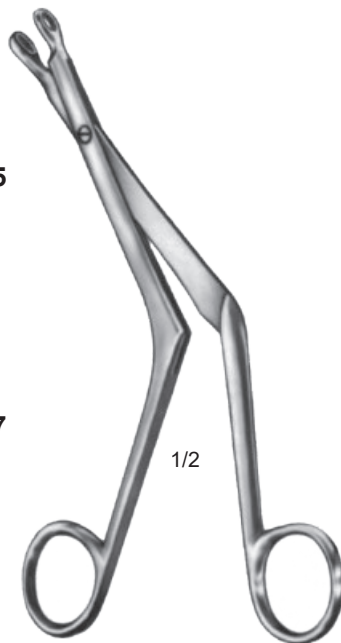

Bruning

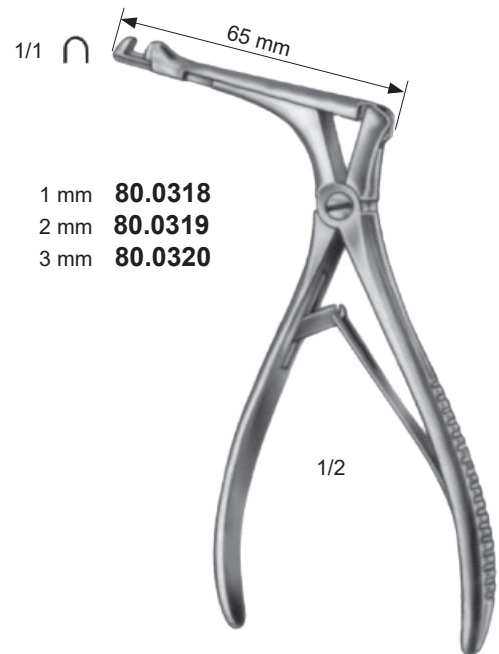

Citelly

- 1 mm **80.0318**
- 2 mm **80.0319**
- 3 mm **80.0320**



tnący górą
 cutting with the top part
 режет верхом



80.0321



tnący dołem
 cutting with the bottom part
 режет низом







80.0322

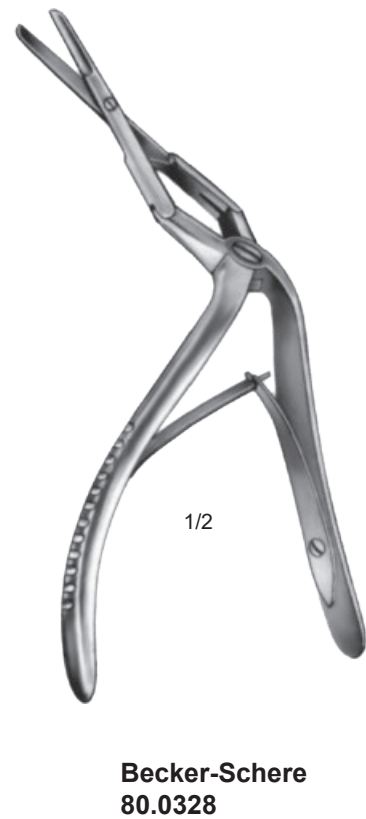
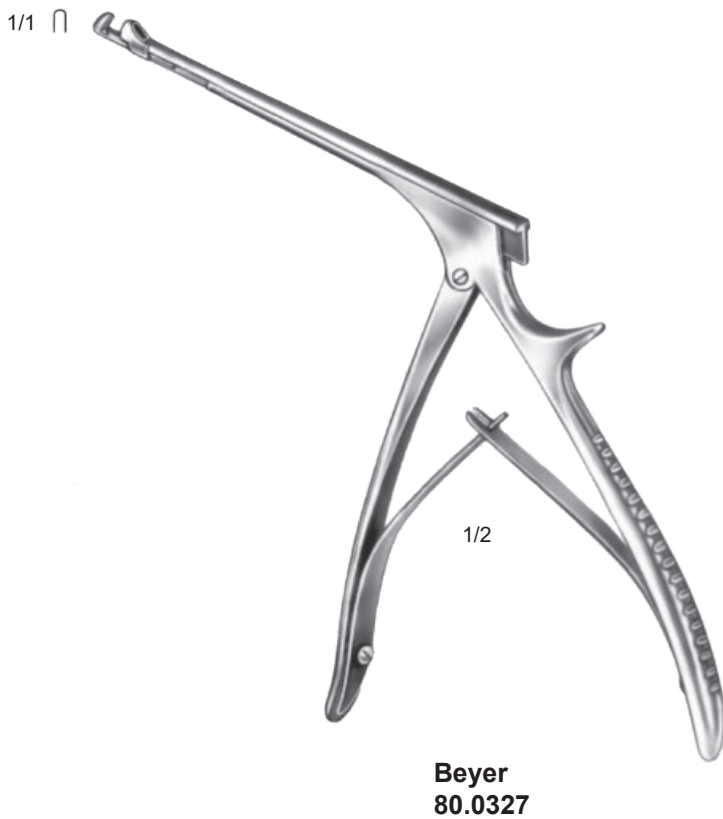
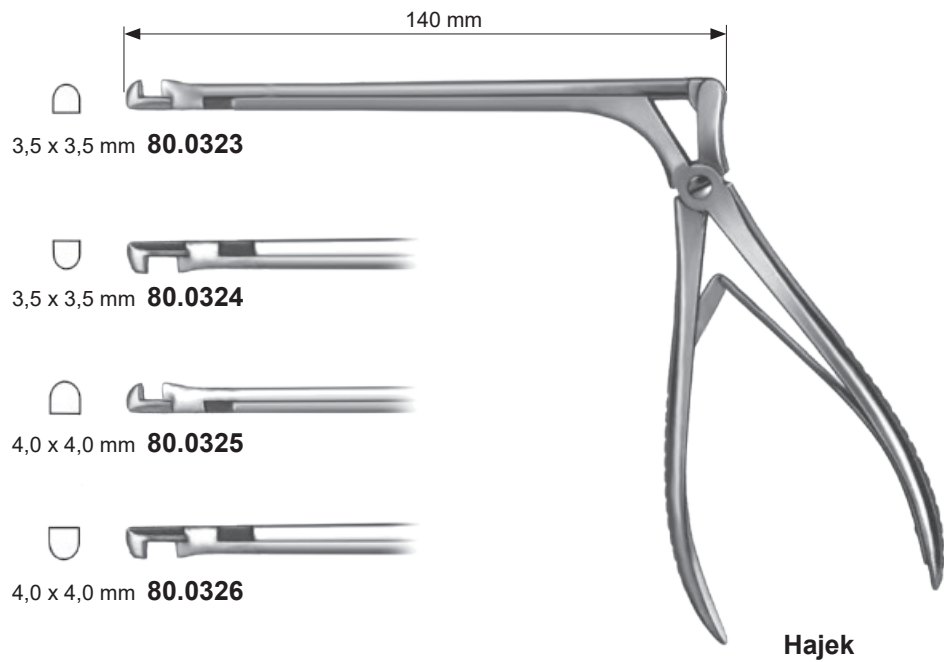

Ferris-Smith



-  3 x 3 mm **80.0329**
-  4 x 4 mm **80.0330**
-  5 x 5 mm **80.0331**
-  6 x 6 mm **80.0332**

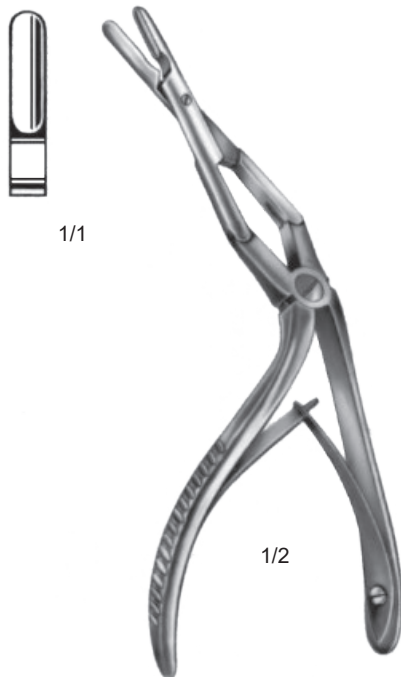

Middleton- Jansen
80.0333
 190 mm

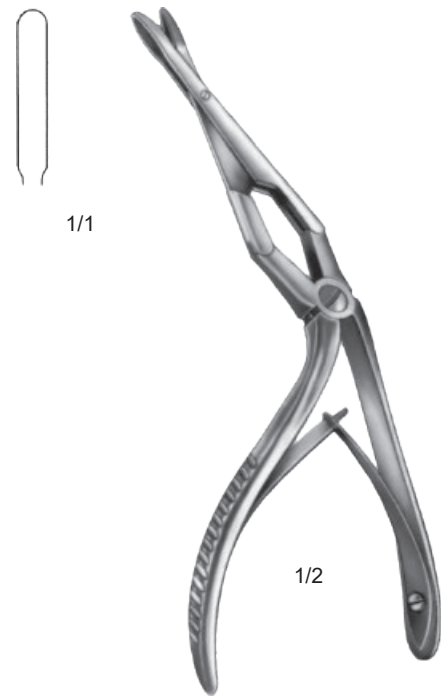

Middleton- Jansen
80.0334
 190 mm

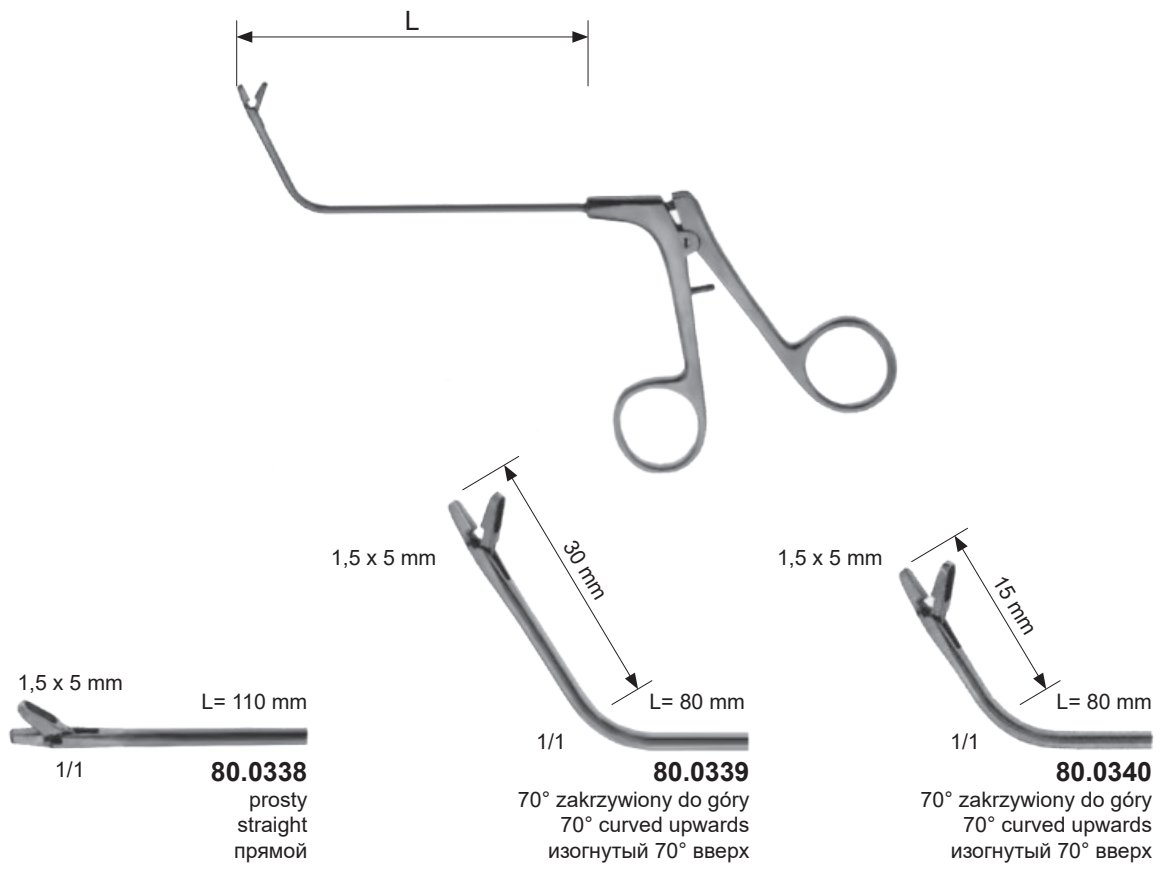
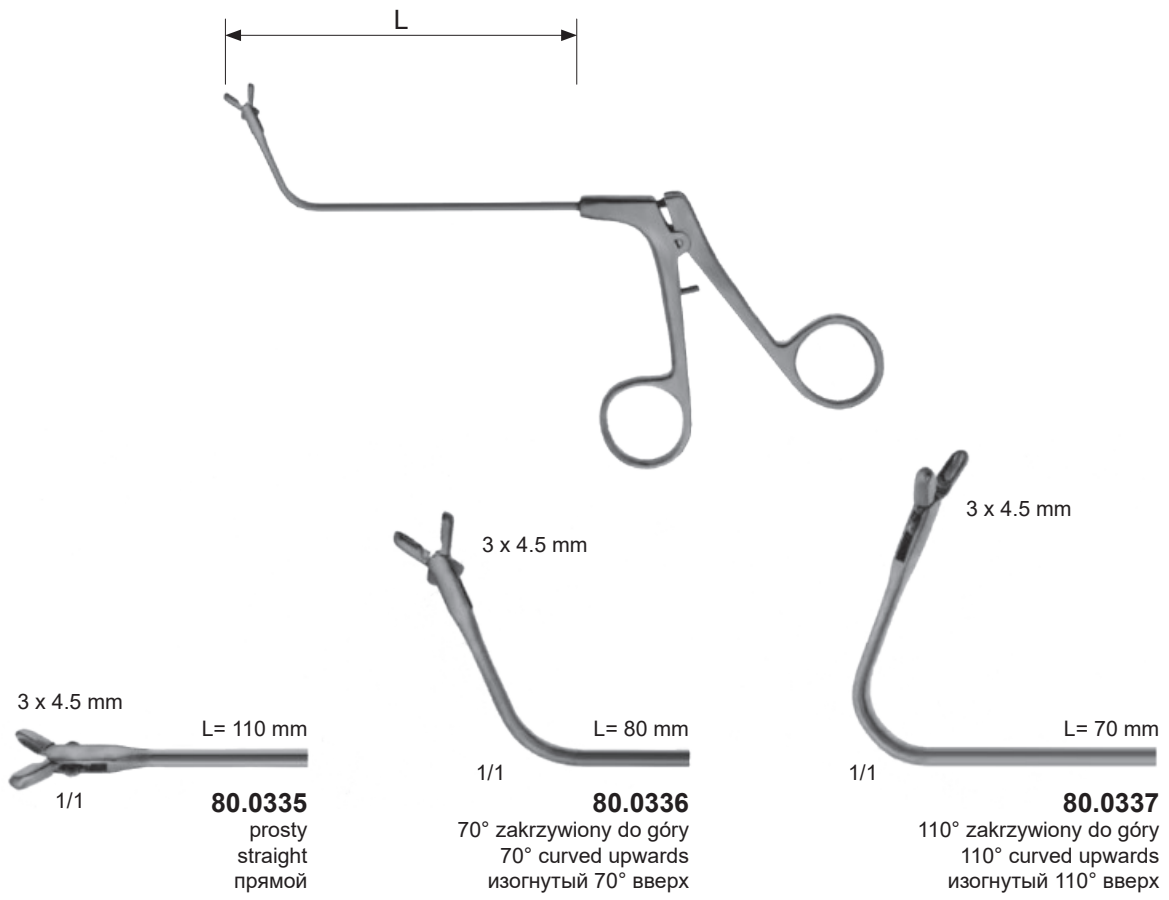



Kevorkian 80.0342



Tischler 80.0343



80.0344



80.0345



Ø4 mm 80.0346



1/2

**Huber
80.0341**



Bruenings

prosty
straight
прямой

L (mm)	prosty straight прямой
200	80.0350
300	80.0351
400	80.0352

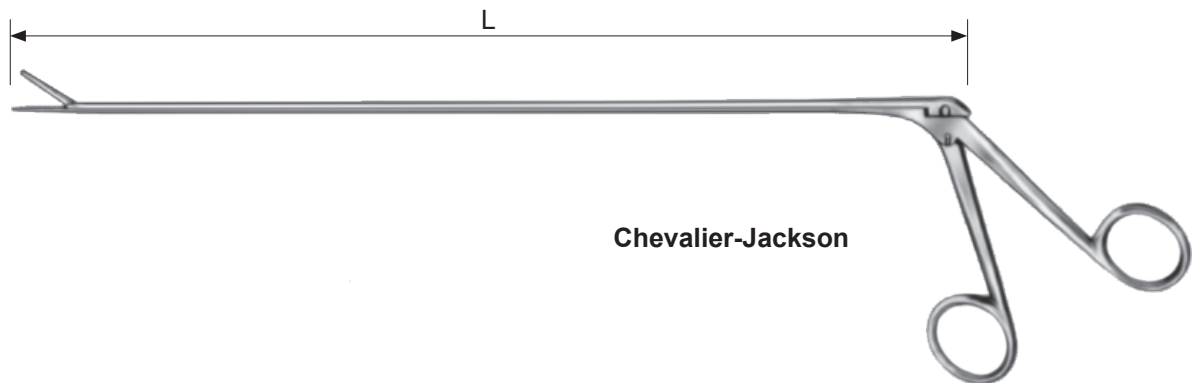

Chevalier-Jackson



L (mm)
300 **80.0362**
400 **80.0363**
500 **80.0364**
600 **80.0365**



L (mm)
300 **80.0366**
400 **80.0367**
500 **80.0368**
600 **80.0369**



L (mm)
300 **80.0370**
400 **80.0371**
500 **80.0372**
600 **80.0373**



L (mm)
300 **80.0374**
400 **80.0375**
500 **80.0376**
600 **80.0377**



L (mm)
300 **80.0382**
400 **80.0383**
500 **80.0384**
600 **80.0385**



L (mm) Ø4 mm
300 **80.0390**
400 **80.0391**
500 **80.0392**
600 **80.0393**



L (mm) Ø4 mm
300 **80.0402**
400 **80.0403**
500 **80.0404**
600 **80.0405**

Kleszczyki krtaniowe do polipów • Laryngeal - Polypus forceps • Зажимы полипные для ларингологии

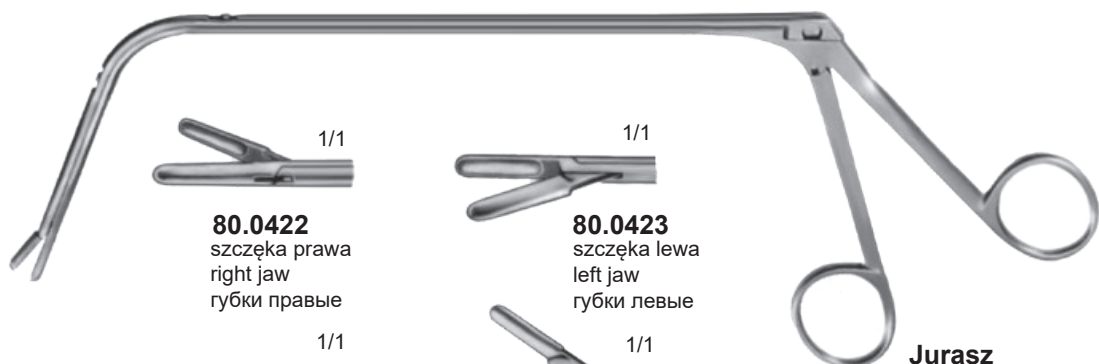

Jurasz





1/1
80.0422
szczeka prawa
right jaw
губки правые

1/1
80.0423
szczeka lewa
left jaw
губки левые

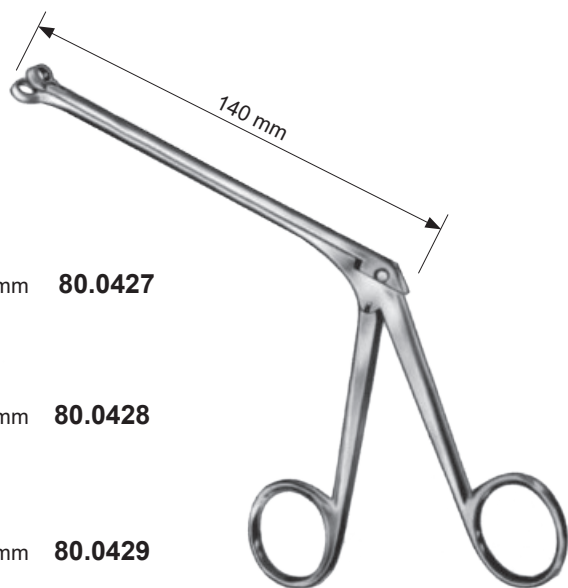
1/1
80.0424
szczeka do dołu
down jaw
губки нижние

1/1
80.0425
szczeka do góry
up jaw
губки верхние







-  1/1 Ø 5 mm **80.0427**
-  1/1 Ø 7 mm **80.0428**
-  1/1 Ø 9 mm **80.0429**
-  1/1 Ø 11 mm **80.0430**

Hartmann



Schmeden

-  1/1 **80.0431** 11 mm
-  1/1 **80.0432** 12 mm
-  1/1 **80.0433** 13 mm

-  1/1 Ø 13 mm **80.0434**

-  1/1 Ø 15 mm **80.0435**

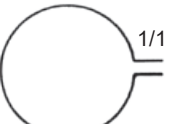
-  1/1 Ø 17 mm **80.0436**

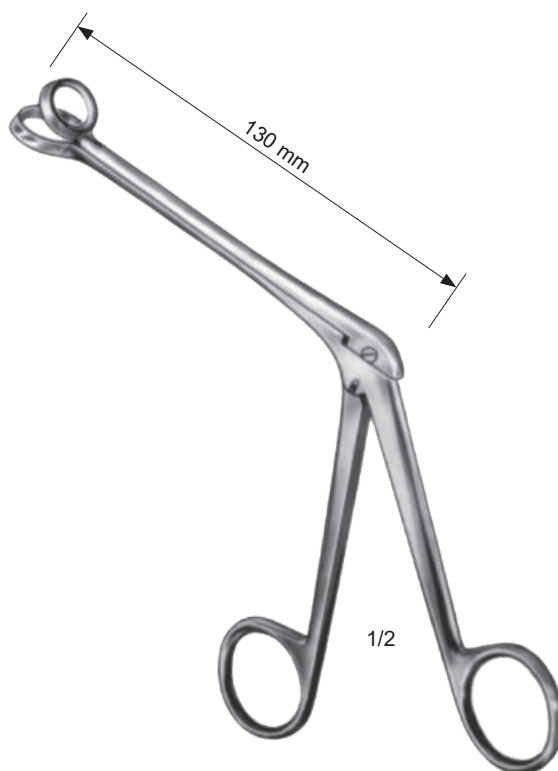

Hartmann

CHM[®]

KLESZCZYKI GINEKOLOGICZNE GYNECOLOGICAL FORCEPS ЗАЖИМЫ ГИНЕКОЛОГИЧЕСКИЕ.....	181
WZIERNIKI GINEKOLOGICZNE VAGINAL SPECULAS ЗЕРКАЛА ГИНЕКОЛОГИЧЕСКИЕ.....	190
ROZSZERZACZE HEGAR HEGAR RETRACTORS РАСШИРИТЕЛИ HEGAR.....	199
SONDY / ŁYŻECZKI GINEKOLOGICZNE UTERINE SOUNDS / CURETTES ЗОНДЫ / ЛОЖКИ ДЛЯ МАТКИ.....	202
KLESZCZE AKUSZERSKIE OBSTETRICAL FORCEPS ЗАЖИМЫ АКУШЕРСКИЕ.....	209
POZOSTAŁE KLESZCZYKI GINEKOLOGICZNE OTHER GYNECOLOGICAL FORCEPS ДРУГИЕ ЗАЖИМЫ ГИНЕКОЛОГИЧЕСКИЕ.....	211



CHM[®]

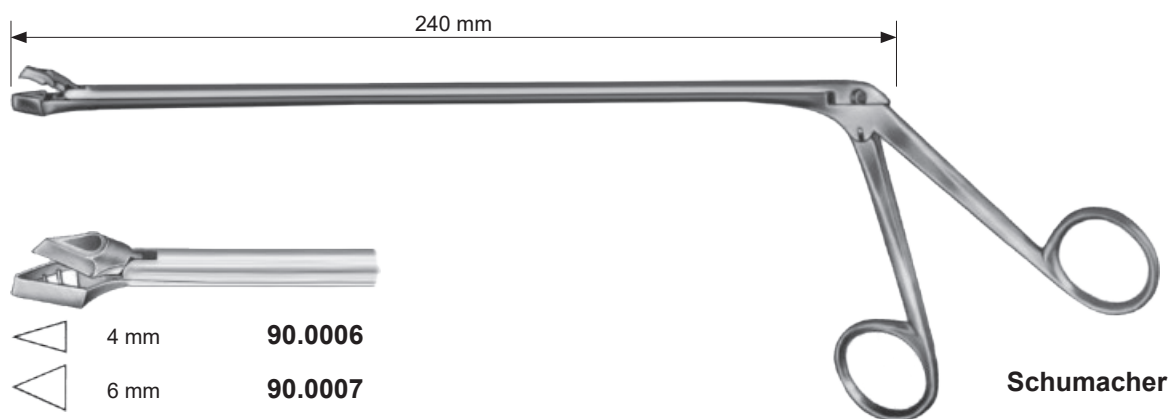
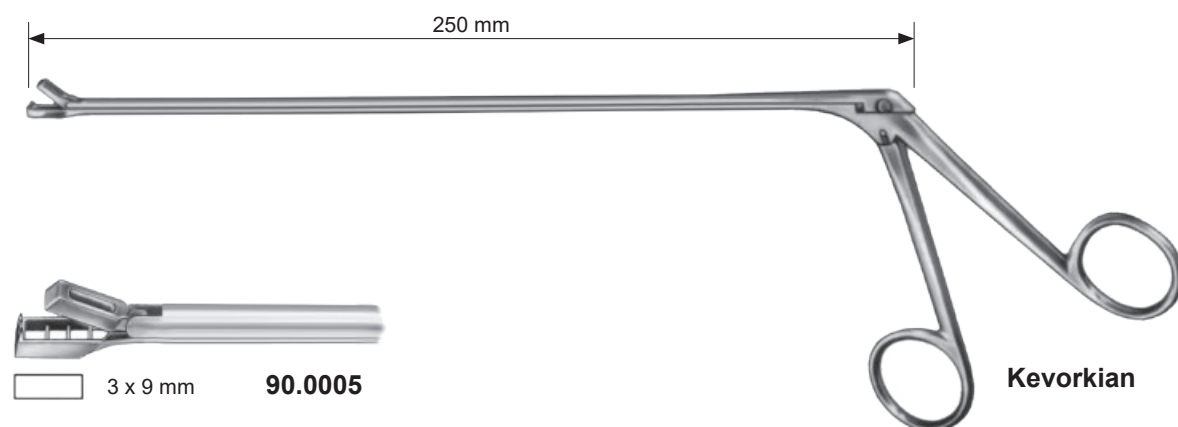
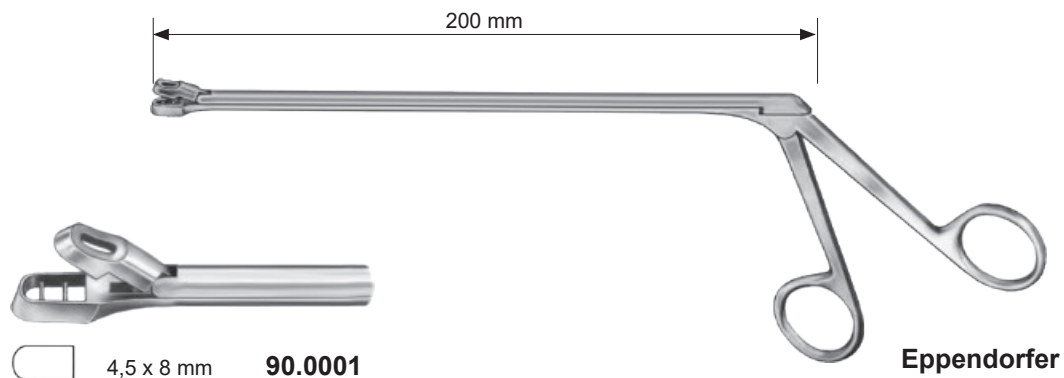

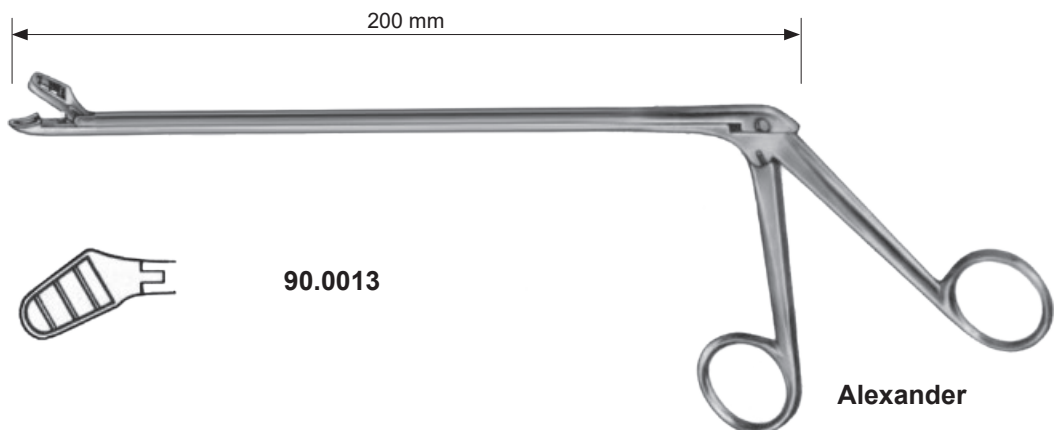
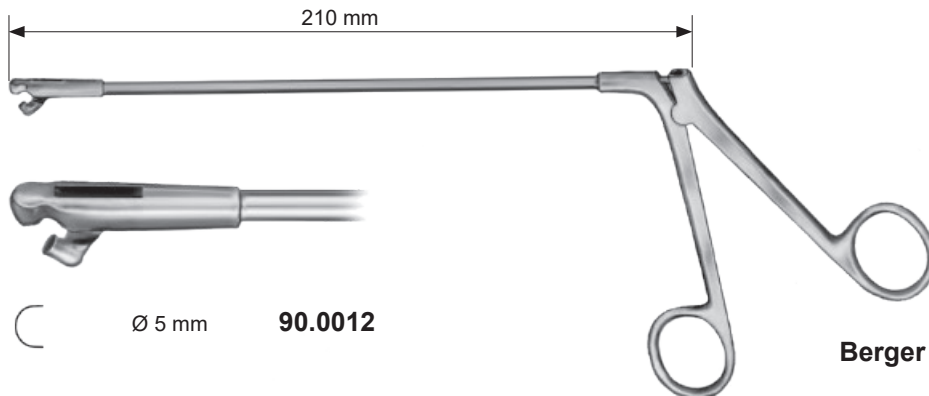
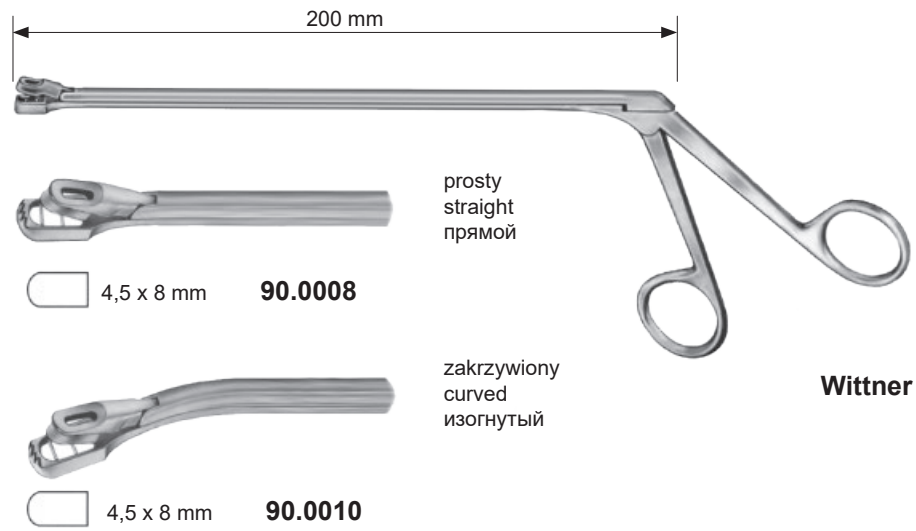



Tischler
90.0014
270 mm



 4 mm **90.0015**

 6 mm **90.0016**

Schumacher
280 mm



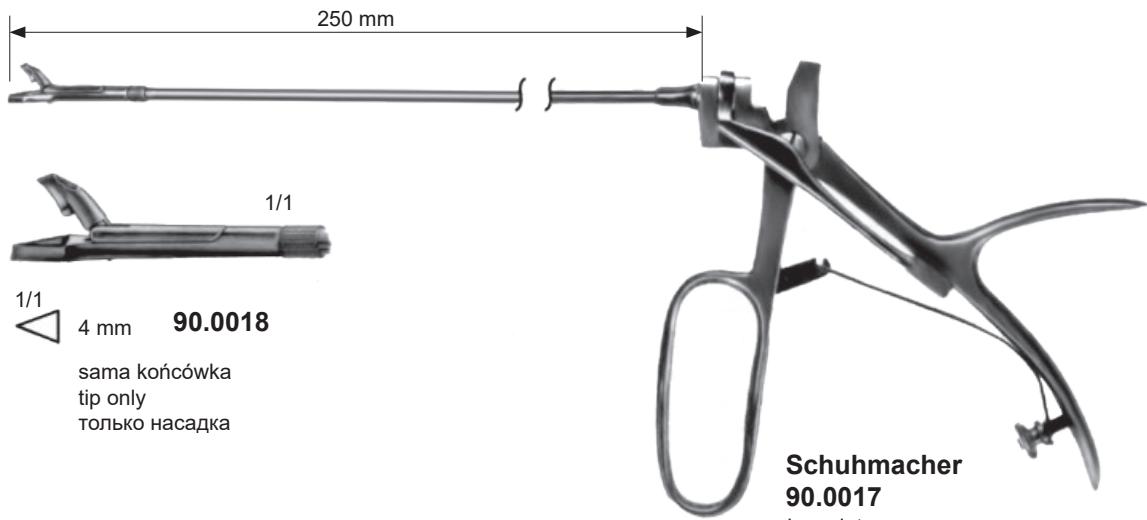

1/1
4 mm **90.0018**

sama końcówka
tip only
только насадка

Schuhmacher
90.0017
komplet
set
комплект

1/1



Schubert
90.0019
260 mm

1/1



Schubert
90.0020
210 mm
90.0021
290 mm



1/1

Van Doren

90.0022
240 mm



1/1

90.0023

1/1



1/1



Van Doren
90.0024
260 mm

1/1



1/1



Van Doren
90.0025
280 mm



Faure
230 mm
90.0026



Thoms-Gaylor
240 mm
90.0027



Gellhorn
230 mm
90.0028

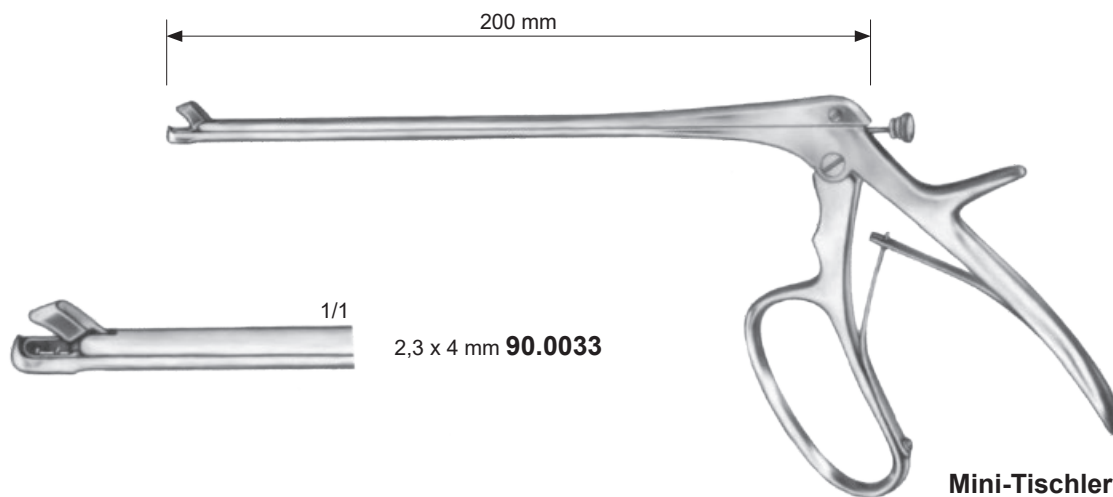
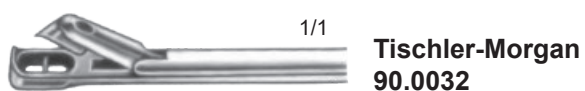
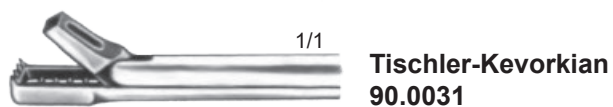
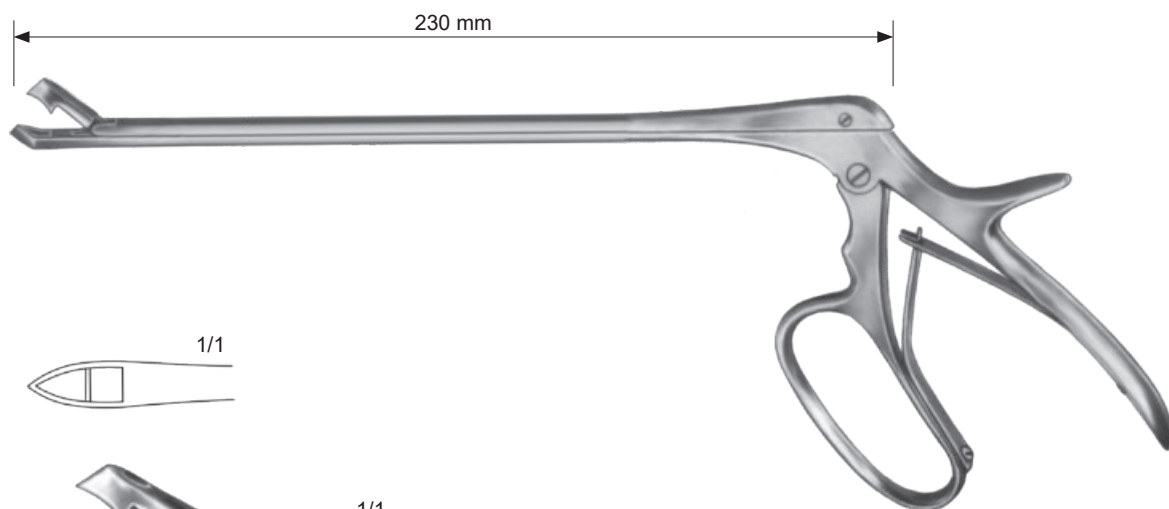

2,3 x 4 mm **90.0033**

Mini-Tischler

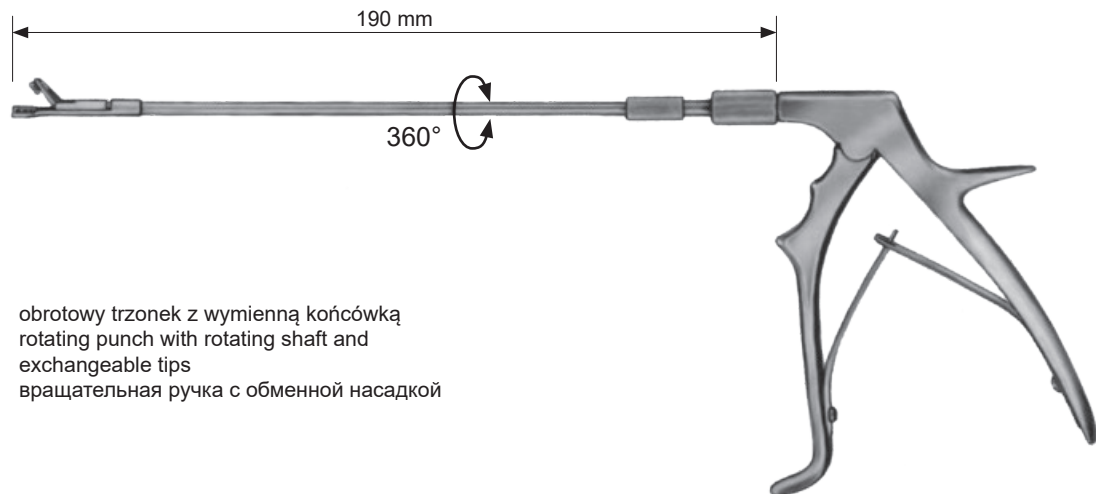

obrotowy trzonek z wymienną końcówką
rotating punch with rotating shaft and
exchangeable tips
вращательная ручка с обменной насадкой

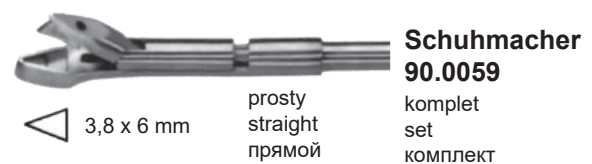
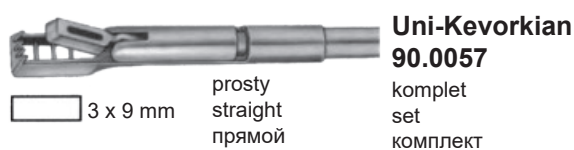
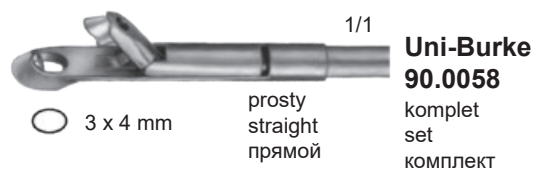
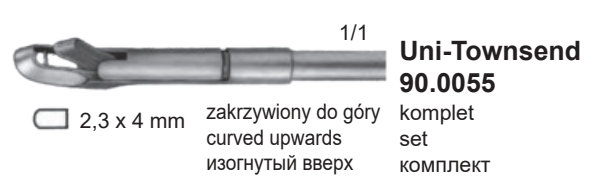
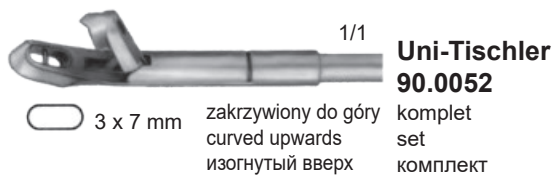
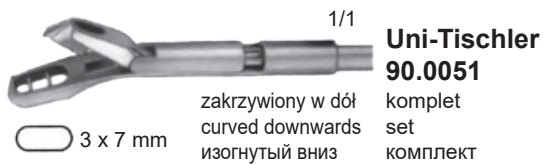



**Uni-Griff
90.0060**



**Uni-Griff
90.0061**

sama końcówka z rurką • only tip with tube • только насадка с трубкой

- | | | |
|------------|--|------------------------------|
| 3 x 7 mm | | Uni-Tischler 90.0062 |
| 3 x 7 mm | | Uni-Tischler 90.0063 |
| 3 x 7 mm | | Uni-Tischler 90.0064 |
| 2,3 x 4 mm | | Uni-Townsend 90.0065 |
| 2,3 x 4 mm | | Uni-Townsend 90.0066 |
| 2,3 x 4 mm | | Uni-Townsend 90.0067 |
| 3 x 5 mm | | Uni-Oval 90.0068 |
| 3 x 9 mm | | Uni-Kevorkian 90.0069 |
| 3 x 4 mm | | Uni-Burke 90.0070 |
| 3,8 x 6 mm | | Schuhmacher 90.0071 |

Kristeller

wziernik • specula • зеркало

90.0100 70x27 mm

90.0101 80x30 mm

90.0102 90x36 mm

hak • retractor • хак

90.0103 75x23 mm

90.0104 85x26 mm

90.0105 100x32 mm

komplet • set • комплект

90.0106 Fig. 1

90.0107 Fig. 2

90.0108 Fig. 3

krótki model

short model

короткий вариант



Kristeller

wziernik • specula • зеркало

90.0109 105x18 mm

90.0110 105x21 mm

hak • retractor • хак

90.0111 110x14 mm

90.0112 110x17 mm

komplet • set • комплект

90.0113 Fig. 00

90.0114 Fig. 0

stożkowy kształt łyżki i haka
with conically shaped blades
с конической формой лезвий



Kristeller

wziernik • specula • зеркало

90.0117.001 105x26 mm

90.0118.001 105x28 mm

90.0119.001 105x33 mm

hak • retractor • хак

90.0117.002 115x22 mm

90.0118.002 115x24 mm

90.0119.002 115x29 mm

komplet • set • комплект

90.0117.000 Fig. 1

90.0118.000 Fig. 2

90.0119.000 Fig. 3

długi model

long model

длинный вариант

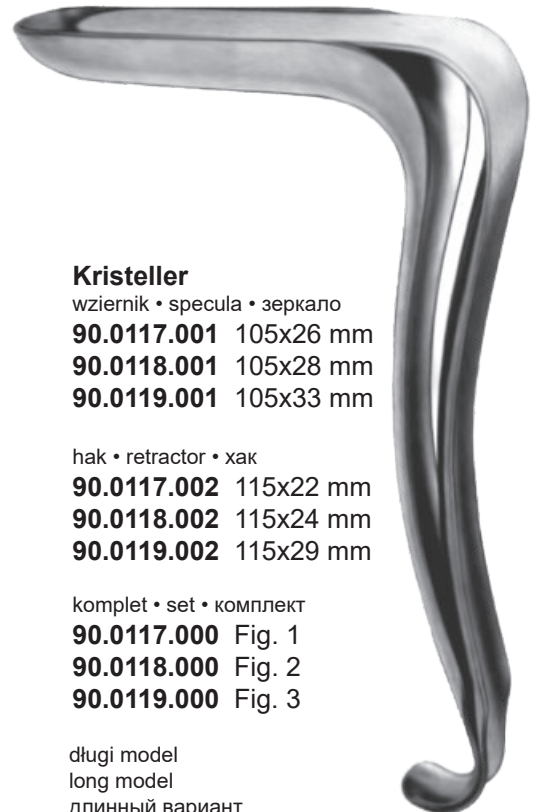

Kristeller

komplet • set • комплект

90.0122 70x15 mm

dla dzieci
for children
для детей



Kallmorgen

komplet • set • комплект

90.0123 70x40 mm

90.0124 90x40 mm

wziernik • specula • зеркало

90.0125 70x40 mm

90.0126 90x40 mm

hak • retractor • хак

90.0127 70x33 mm

90.0128 90x33 mm

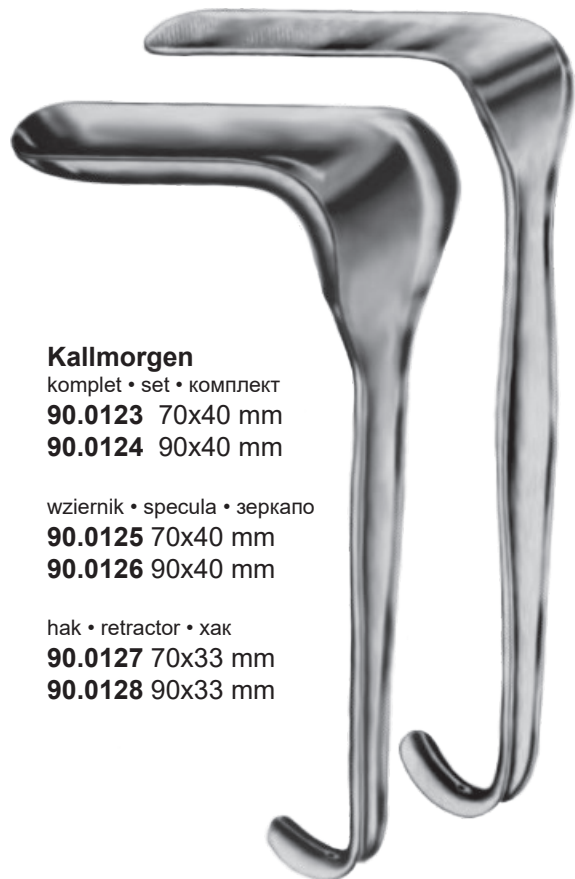



podwójny
double
двойной

Sims

90.0129 25x30 mm

90.0130 30x35 mm

90.0131 35x40 mm



Semm

90.0132 95x14/18 mm

90.0133 100x20/25 mm

90.0134 105x27/35 mm



Doyen 70x30 mm

90.0135

240 mm

Breisky

290 mm

90.0136 100x20 mm

90.0137 100x25 mm

90.0138 100x30 mm

90.0139 100x35 mm

90.0140 100x40 mm

320 mm

90.0141 130x20 mm

90.0142 130x25 mm

90.0143 130x30 mm

90.0144 130x35 mm

90.0145 130x40 mm

350 mm

90.0146 155x40 mm



lekko wklęsły
slightly concave
слегка вогнутый

Doyen

90.0147 60x35 mm
90.0148 90x35 mm
90.0149 120x35 mm
90.0150 160x35 mm

90.0151 60x45 mm
90.0152 90x45 mm
90.0153 120x45 mm
90.0154 160x45 mm

90.0155 60x60 mm
90.0156 90x60 mm
90.0157 120x60 mm
90.0158 160x60 mm

wziernik • specula • зеркало
90.0159 95x17 - 30 mm



hak • retractor • хак
90.0160 95x17 - 20 mm



Mathieu 210 mm



Grave

90.0161 85x33 mm

90.0162 95x33 mm

90.0163 105x33 mm

dla dziewic
for virgins
для девственных



Cusco

90.0164 85x17 mm



Cusco

90.0165 90x23/25 mm

90.0166 100x25/27 mm

90.0167 110x27/30 mm



Cusco

90.0168 75x32 mm

90.0169 85x35 mm

90.0170 100x35 mm

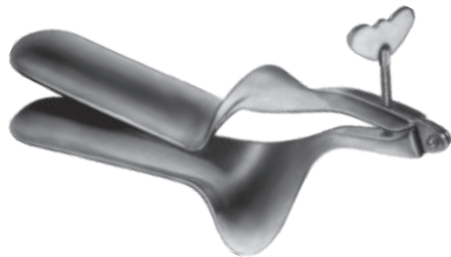

Collin
90.0171 90x29 mm
90.0172 95x35 mm
90.0173 110x40 mm



Pederson
90.0174 75x13 mm
90.0175 100x22 mm
90.0176 120x25 mm



Seyffert 230 mm
90.0177 100x17 mm
90.0178 110x33 mm



Auvard 75x38 mm

90.0179

z odłączanym ciężarkiem
with detachable weight
с отделмой гирей

90.0180

z ciężarkiem
with fixed weight
с установленной гирей



90.0184 Scherbak

zestaw składający się z ciężarka (90.0181),
uchwyty i 5 końcówek
set consisting of weight (90.0181),
handle and 5 blades
комплект состоящий с гири (90.0181),
ручки и 5 лезвий

90.0183

uchwyty
handle
ручка

90.0181 400g

90.0182 800g

ciężarek
weight
гиря



90.0185 80x30 mm

90.0186 85x35 mm

90.0187 90x40 mm



90.0188 55x40/60 mm

90.0189 70x45/70 mm

izolowane , stosowane w lasero- i elektrochirurgii • insulated , used in Laser- and Electrosurgery • изолированные , использованные в лазер- и электрохирургии



Grave

- 90.0190** 75x20 mm
- 90.0191** 95x35 mm
- 90.0192** 115x35 mm

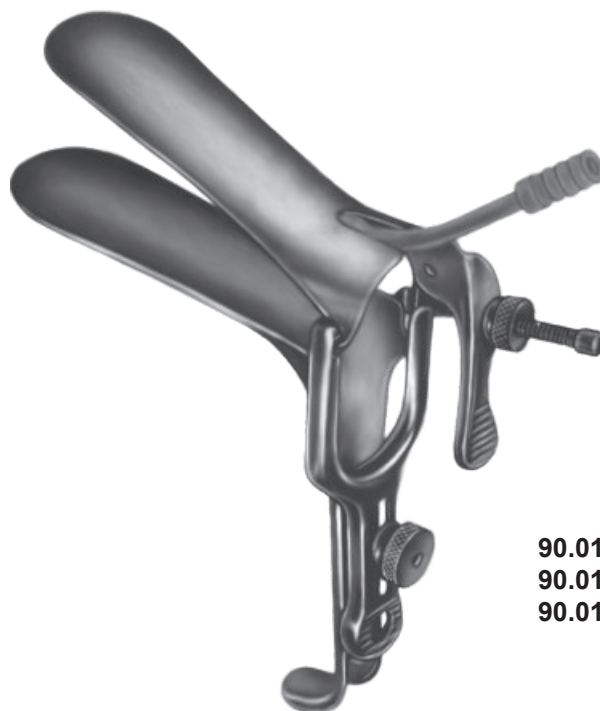

Peterson

- 90.0193** 75x13 mm
- 90.0194** 100x22 mm
- 90.0195** 120x25 mm

haki poprzeczne • lateral retractors • хаки боковые



Lateral Retraktor
2x45° zakrzywiony
2x45° curved
2x45° изогнутый

90.0196
90.0197*)



Lateral Retraktor
2x45° zakrzywiony
2x45° curved
2x45° изогнутый

90.0198
90.0199*)



Hak poprzeczny ułatwia dostęp i obejrzenie szyjki macicy podczas zabiegu

The Lateral Vaginal Retractor improves access and viewing of the cervix during a procedure.

Хак боковой облегчает осмотреть шейку матки во время операции

*) izolowane- stosowane w lasero- i elektrochirurgii • used in Laser- and Electrosurgery • использованные в лазер- и электрохирургии



Kogan
280 mm
z zapadką
with ratchet
с замком



4 x 23 mm 6 x 23 mm
90.0200 **90.0202**
90.0201*) **90.0203*)**



3 x 23 mm
90.0204
90.0205*)



Kogan
90.0206
240 mm
bez zapadki
without ratchet
без замка



6 x 23 mm



Kogan
90.0207
240 mm
z zapadką śrubową
with screw ratchet
с винтовым замком

*) izolowane- stosowane w lasero- i elektrochirurgii • used in Laser- and Electrosurgery • использованные в лазер- и электрохирургии



Hegar

90.0229 1 mm	90.0259 1,5 mm
90.0230 2 mm	90.0260 2,5 mm
90.0231 3 mm	90.0261 3,5 mm
90.0232 4 mm	90.0262 4,5 mm
90.0233 5 mm	90.0263 5,5 mm
90.0234 6 mm	90.0264 6,5 mm
90.0235 7 mm	90.0265 7,5 mm
90.0236 8 mm	90.0266 8,5 mm
90.0237 9 mm	90.0267 9,5 mm
90.0238 10 mm	90.0268 10,5 mm
90.0239 11 mm	90.0269 11,5 mm
90.0240 12 mm	90.0270 12,5 mm
90.0241 13 mm	90.0271 13,5 mm
90.0242 14 mm	90.0272 14,5 mm
90.0243 15 mm	90.0273 15,5 mm
90.0244 16 mm	90.0274 16,5 mm
90.0245 17 mm	90.0275 17,5 mm
90.0246 18 mm	90.0276 18,5 mm
90.0247 19 mm	90.0277 19,5 mm
90.0248 20 mm	90.0278 20,5 mm
90.0249 21 mm	90.0279 21,5 mm
90.0250 22 mm	90.0280 22,5 mm
90.0251 23 mm	90.0281 23,5 mm
90.0252 24 mm	
90.0253 25 mm	
90.0254 26 mm	
90.0255 27 mm	
90.0256 28 mm	
90.0257 29 mm	
90.0258 30 mm	

komplet • set • набор

90.0282 4-17 mm

14 sztuk w komplecie • pieces per set • частей в наборе

90.0283 1-26 mm

26 sztuk w komplecie • pieces per set • частей в наборе

Hegar

- w skórzanym futerale
- in leather pouch
- в кожаном футляре



90.0284 4 - 17 mm

14 sztuk w komplecie • 14 pieces per set • 14 частей в наборе

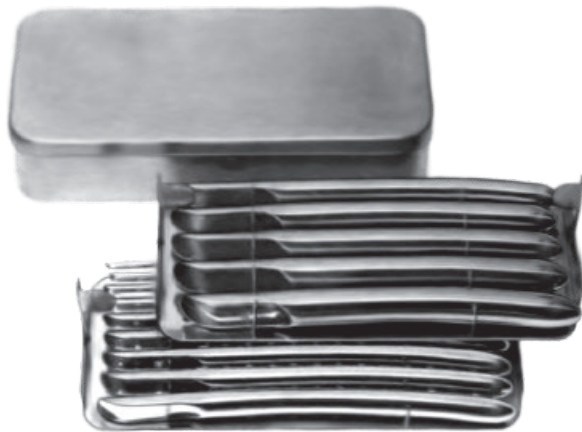

tylko kasetka na:
metal case only, for:
только металлический ящик для:

90.0287 4 - 17 mm

14 sztuk w komplecie • pieces per set • частей в наборе

90.0288 1 - 26 mm

26 sztuk w komplecie • pieces per set • частей в наборе

Hegar

- w metalowej kasetce
- in metal case
- в металлическо ящике

90.0285 4 - 17 mm

14 sztuk w komplecie • 14 pieces per set • 14 частей в наборе

90.0286 1 - 26 mm

26 sztuk w komplecie • 26 pieces per set • 26 частей в наборе



Hegar

- podwójny w metalowej kasetce
- double in metal case
- двойной в металлическом ящике

90.0289 3/4 - 17/18 mm

8 sztuk w komplecie • pieces per set • частей в наборе

90.0290 1/2 - 25/26 mm

13 sztuk w komplecie • pieces per set • частей в наборе

tylko kasetka na:
metal case only, for:

только металлическом ящике для:

90.0291 3/4 - 17/18 mm

8 sztuk w komplecie • pieces per set • частей в наборе

90.0292 1/2 - 25/26 mm

13 sztuk w komplecie • pieces per set • частей в наборе



Hegar

- podwójny w zwijanym brezencie
- double in canvas roll
- двойной в холсте

90.0293 3/4 - 17/18 mm

8 sztuk w komplecie • pieces per set • частей в наборе



Hegar

podwójny • double • двойной

90.0294 1/2 mm

90.0295 3/4 mm

90.0296 5/6 mm

90.0297 7/8 mm

90.0298 9/10 mm

90.0299 11/12 mm

90.0300 13/14 mm

90.0301 15/16 mm

90.0302 17/18 mm

90.0303 19/20 mm

90.0304 21/22 mm

90.0305 23/24 mm

90.0306 25/26 mm

komplet • set • набор

90.0307 3/4 - 17/18 mm

8 sztuk w komplecie • pieces per set • частей в наборе

90.0308 1/2 - 25/26 mm

13 sztuk w komplecie • pieces per set • частей в наборе



Sims 320 mm

90.0316

sztywna, z podziałką w cm
rigid, graduated in cm
твердый, степенный в см

90.0317

giętka, z podziałką w cm
malleable, graduated in cm
пружинчатый, степенный в см



Martin 320 mm

90.0318

giętka, z podziałką w cm
malleable, graduated in cm
пружинчатый, степенный в см



Braun 275 mm

90.0319

depresor ginekologiczny
uterine depressor
депрессор для матки

1 mm

Ø4,5 mm



wąska
narrow
узкая

Kevorkian
90.0320 300 mm



łyżeczka obrotowa
rotating curette
ложка вращательная

Rotokürette
90.0321 300 mm



Novak 230 mm
90.0322 1 mm
90.0323 2 mm
90.0324 3 mm
90.0325 4 mm

Ø4 mm



Randall
90.0326 240 mm



Kevorkian
90.0327 2,5 mm

bez siatki, kanciasta
without basket, angular
без сетки, угловая

Kevorkian-Young
90.0328 2,5 mm

z siatką, kanciasta
with basket, angular
с сеткой, угловая

Kevorkian
90.0329 2,2 mm

z siatką, zaokrąglona
with basket, round
с сеткой, круглая

Kevorkian 300 mm



Mod. Muenchen
 90.0330 270 mm



Novak-Schoeckaert
 90.0331 240 mm



Blake
 90.0332 270 mm



Zwiefel
 90.0333 310 mm

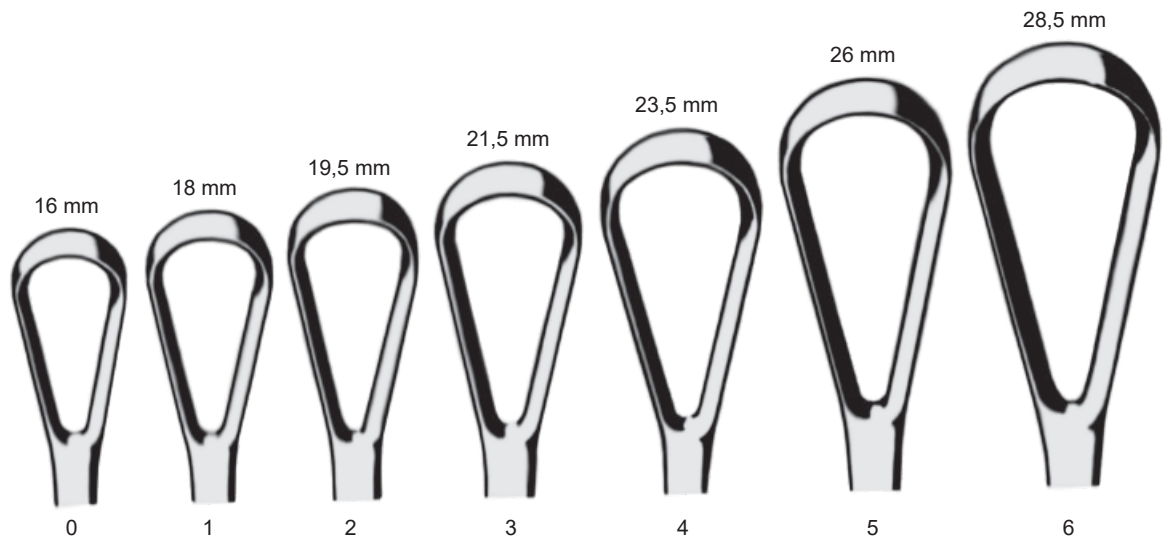

Bumm 280 mm

	ostra, giętka sharp, malleable острая, пружинчатая	tępa, giętka blunt, malleable тупая, пружинчатая
Fig. 0	90.0334	90.0341
Fig. 1	90.0335	90.0342
Fig. 2	90.0336	90.0343
Fig. 3	90.0337	90.0344
Fig. 4	90.0338	90.0345
Fig. 5	90.0339	90.0346
Fig. 6	90.0340	90.0347



Sims 250 mm

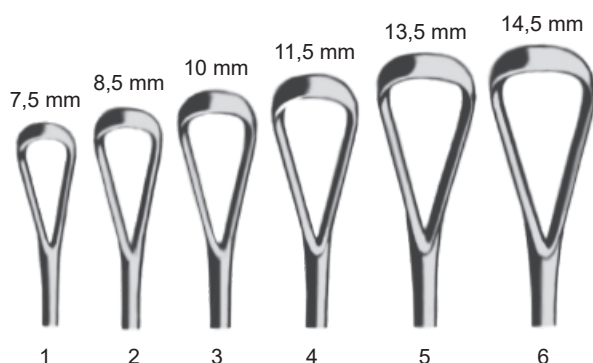

	ostra, giętka sharp, malleable острая, пружинчатая	ostra, sztywna sharp, rigid острая, жёсткая	tępa, giętka blunt, malleable тупая, пружинчатая	tępa, sztywna blunt, rigid тупая, жёсткая
Fig. 1	90.0348	90.0354	90.0360	90.0366
Fig. 2	90.0349	90.0355	90.0361	90.0367
Fig. 3	90.0350	90.0356	90.0362	90.0368
Fig. 4	90.0351	90.0357	90.0363	90.0369
Fig. 5	90.0352	90.0358	90.0364	90.0370
Fig. 6	90.0353	90.0359	90.0365	90.0371

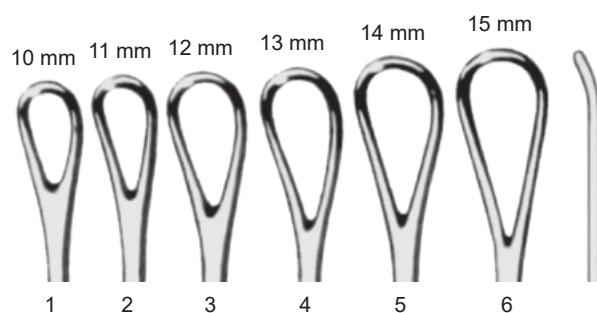

Thomas 280 mm



	tępa, giętka, gładka blunt, malleable, smooth тупая, пружинчатая, гладкая
Fig. 1	90.0372
Fig. 2	90.0373
Fig. 3	90.0374
Fig. 4	90.0375
Fig. 5	90.0376
Fig. 6	90.0377



Recamier
310 mm

		ostra, giętka sharp, malleable острая, пружинчатая	ostra, sztywna sharp, rigid острая, жёсткая	tępa, giętka blunt, malleable тупая, пружинчатая	tępa, sztywna blunt, rigid тупая, жёсткая
Fig. 00	5 mm	90.0378	90.0396	90.0414	90.0432
Fig. 0	6 mm	90.0379	90.0397	90.0415	90.0433
Fig. 1	7 mm	90.0380	90.0398	90.0416	90.0434
Fig. 2	8 mm	90.0381	90.0399	90.0417	90.0435
Fig. 3	9 mm	90.0382	90.0400	90.0418	90.0436
Fig. 4	11 mm	90.0383	90.0401	90.0419	90.0437
Fig. 5	12 mm	90.0384	90.0402	90.0420	90.0438
Fig. 6	14 mm	90.0385	90.0403	90.0421	90.0439
Fig. 7	15 mm	90.0386	90.0404	90.0422	90.0440
Fig. 8	16 mm	90.0387	90.0405	90.0423	90.0441
Fig. 9	19 mm	90.0388	90.0406	90.0424	90.0442
Fig. 10	20 mm	90.0389	90.0407	90.0425	90.0443
Fig. 11	21 mm	90.0390	90.0408	90.0426	90.0444
Fig. 12	23 mm	90.0391	90.0409	90.0427	90.0445
Fig. 13	25 mm	90.0392	90.0410	90.0428	90.0446
Fig. 14	30 mm	90.0393	90.0411	90.0429	90.0447
Fig. 15	35 mm	90.0394	90.0412	90.0430	90.0448
Fig. 16	40 mm	90.0395	90.0413	90.0431	90.0449



16

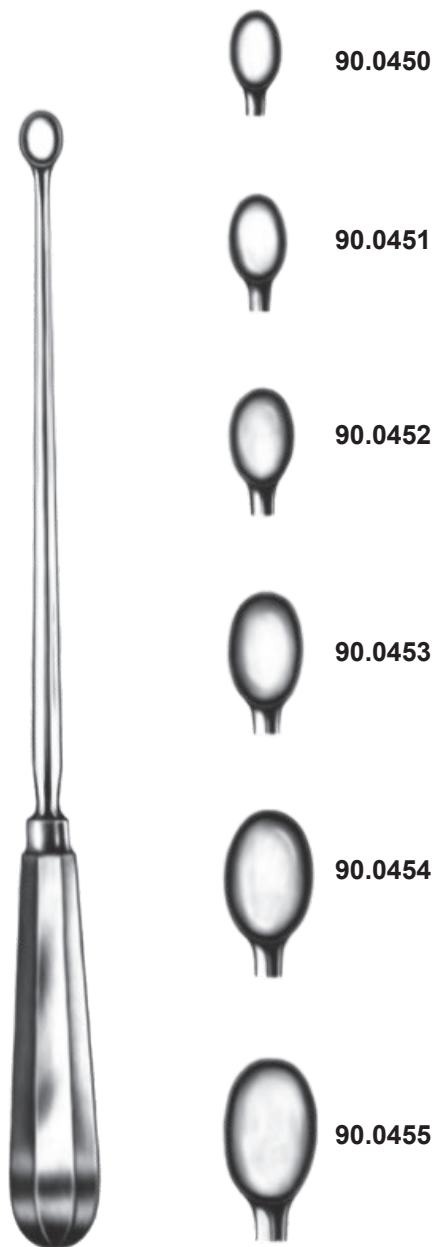

Schroeder 300 mm

ostra, sztywna
sharp, rigid
острая, жёсткая

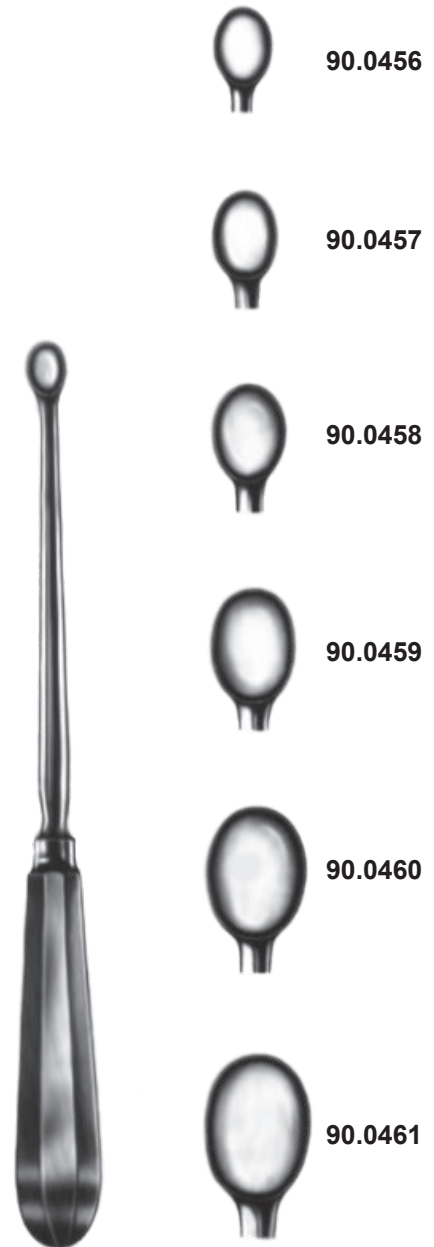

Simon 250 mm

ostra, sztywna
sharp, rigid
острая, жёсткая



Naegele
90.0462 360 mm
90.0463 400 mm



Mc Lean-Tucker
90.0464 390 mm



Elliot
90.0465 380 mm



Simpson-Braun
90.0466 300 mm
90.0467 330 mm
90.0468 360 mm



Simpson-Luikart
90.0469 360 mm



Piper
90.0470 440 mm



Kielland
90.0471 410 mm



Kielland-Luikart
90.0472 410 mm



Martin
90.0473 340 mm



Collin
90.0474 350 mm

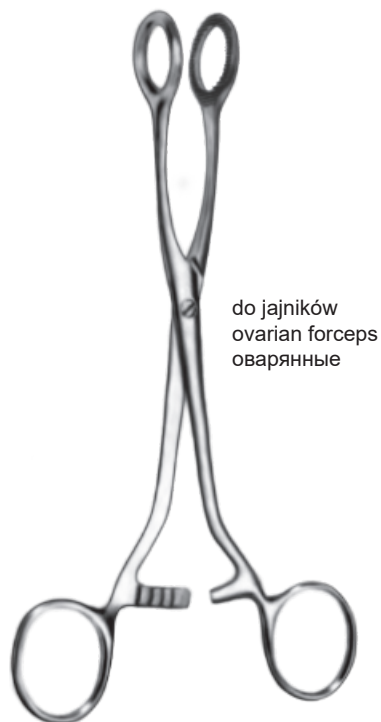

do jajników
ovarian forceps
оварянные

Doyen
90.0475 200 mm



Collin
90.0476 250 mm



Sommer
90.0477 230 mm



Dartigues
90.0478 270 mm



Noto
90.0479 270 mm



Kelly
90.0480 320 mm



Doyen
90.0481 170 mm

śruby do mięśniaków
myoma screws
ВИНТЫ ДЛЯ МИОМЫ



Doyen
90.0482 170 mm



Winter 280 mm

prosty
straight
прямой

90.0483

90.0484

90.0485

zagięty
curved
загнутый

90.0486

90.0487

90.0488

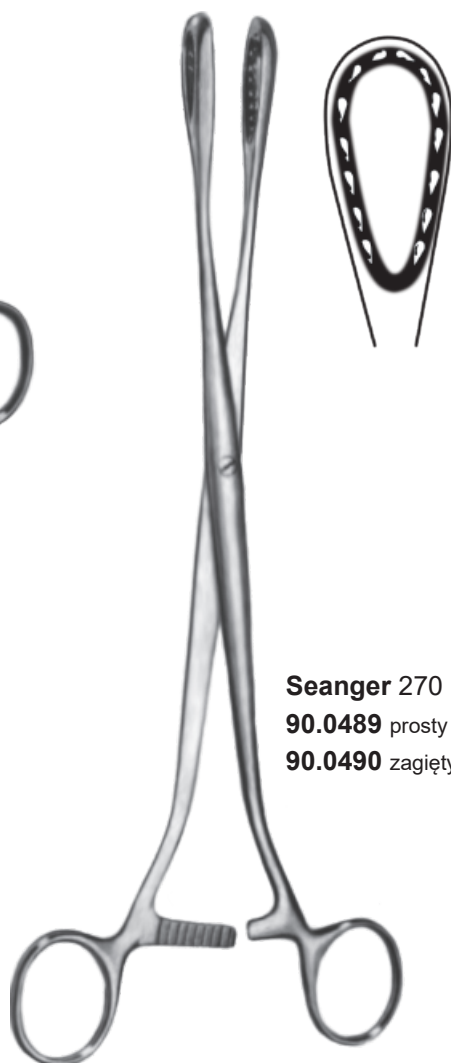

Seanger 270 mm

90.0489 prosty • straight • прямой

90.0490 zagięty • curved • загнутый

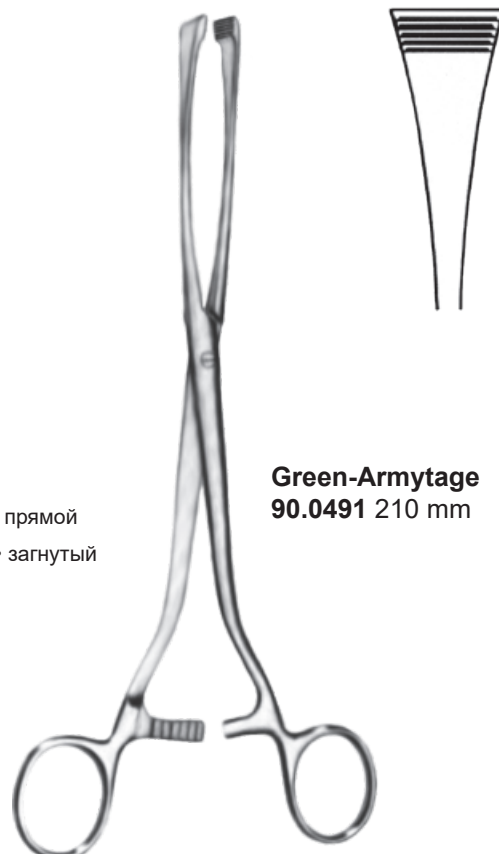

Green-Armytage

90.0491 210 mm

CHM[®]



ПОЕМНИКИ/ TACE METALOWE
STERYLIZING TRAYS/ TINWARES
МЕТАЛЛИЧЕСКИЕ КОНТЕЙНЕРЫ.....217

ИННЕ/ OTHERS/ ДРУГИЕ



CHM[®]



Taca z drutu stalowego
Steel wire tray
Поднос из проволоки

12.0318.030 540 x 250 x 30 mm
12.0318.050 540 x 250 x 50 mm
12.0318.070 540 x 250 x 70 mm
12.0318.100 540 x 250 x 100 mm

12.0319.030 405 x 250 x 30 mm
12.0319.050 405 x 250 x 50 mm
12.0319.070 405 x 250 x 70 mm
12.0319.100 405 x 250 x 100 mm

12.0316.043 274 x 172 x 43 mm
12.0317.050 267 x 125 x 50 mm

12.0320.030 480 x 250 x 30 mm
12.0320.050 480 x 250 x 50 mm
12.0320.070 480 x 250 x 70 mm
12.0320.100 480 x 250 x 100 mm

12.0321.030 255 x 250 x 30 mm
12.0321.050 255 x 250 x 50 mm
12.0321.070 255 x 250 x 70 mm
12.0321.100 255 x 250 x 100 mm



Taca z drutu stalowego z pokrywą
Steel wire tray with lid
Поднос из проволоки с крышкой

12.0318.031 540 x 250 x 30 mm
12.0318.051 540 x 250 x 50 mm
12.0318.071 540 x 250 x 70 mm
12.0318.101 540 x 250 x 100 mm

12.0319.031 405 x 250 x 30 mm
12.0319.051 405 x 250 x 50 mm
12.0319.071 405 x 250 x 70 mm
12.0319.101 405 x 250 x 100 mm

12.0316.143 274 x 172 x 43 mm
12.0317.051 267 x 125 x 50 mm

12.0320.031 480 x 250 x 30 mm
12.0320.051 480 x 250 x 50 mm
12.0320.071 480 x 250 x 70 mm
12.0320.101 480 x 250 x 100 mm

12.0321.031 255 x 250 x 30 mm
12.0321.051 255 x 250 x 50 mm
12.0321.071 255 x 250 x 70 mm
12.0321.101 255 x 250 x 100 mm



Taca z drutu stalowego z pokrywą
Steel wire tray with lid
Поднос из проволоки с крышкой

12.0439 670 x 80 x 52 mm
12.0440 460 x 80 x 52 mm
12.0441 290 x 80 x 52 mm

12.0442 640 x 150 x 77 mm

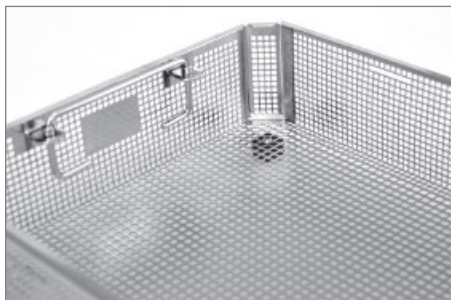

Taca z blachy perforowanej
Perforated sheet tray
Поднос из перфорированного металлического листа

12.0322.030	540 x 253 x 30 mm	12.0324.030	244 x 253 x 30 mm
12.0322.050	540 x 253 x 50 mm	12.0324.050	244 x 253 x 50 mm
12.0322.070	540 x 253 x 70 mm	12.0324.070	244 x 253 x 70 mm
12.0322.100	540 x 253 x 100 mm	12.0324.100	244 x 253 x 100 mm
12.0323.030	485 x 253 x 30 mm	12.0325.040	275 x 175 x 40 mm
12.0323.050	485 x 253 x 50 mm	12.0325.095	275 x 175 x 95 mm
12.0323.070	485 x 253 x 70 mm	12.0326.050	265 x 125 x 50 mm
12.0323.100	485 x 253 x 100 mm		
12.0327.030	405 x 253 x 30 mm		
12.0327.050	405 x 253 x 50 mm		
12.0327.070	405 x 253 x 70 mm		
12.0327.100	405 x 253 x 100 mm		

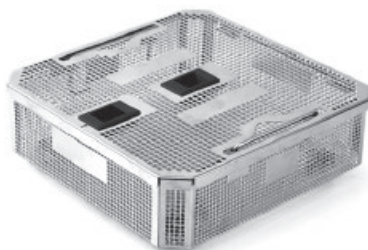
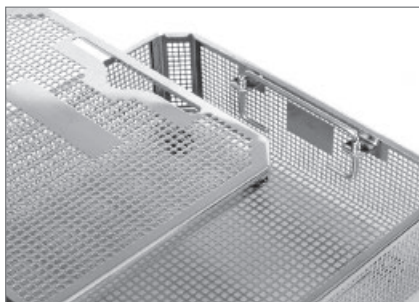

Taca z blachy perforowanej z pokrywą
Perforated sheet tray with lid
Поднос из перфорированного металлического листа с крышкой

12.0322.031	540 x 253 x 30 mm	12.0324.031	244 x 253 x 30 mm
12.0322.051	540 x 253 x 50 mm	12.0324.051	244 x 253 x 50 mm
12.0322.071	540 x 253 x 70 mm	12.0324.071	244 x 253 x 70 mm
12.0322.101	540 x 253 x 100 mm	12.0324.101	244 x 253 x 100 mm
12.0323.031	485 x 253 x 30 mm	12.0325.041	275 x 175 x 40 mm
12.0323.051	485 x 253 x 50 mm	12.0325.195	275 x 175 x 95 mm
12.0323.071	485 x 253 x 70 mm	12.0326.051	265 x 125 x 50 mm
12.0323.101	485 x 253 x 100 mm		
12.0327.031	405 x 253 x 30 mm		
12.0327.051	405 x 253 x 50 mm		
12.0327.071	405 x 253 x 70 mm		
12.0327.101	405 x 253 x 100 mm		

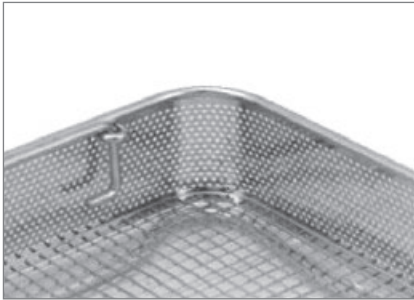

Taca z drutu stalowego i blachy perforowanej
Steel wire and perforated sheet tray
Поднос из проволоки и перфорированного металлического листа

12.0431.050	540 x 250 x 50 mm	12.0433.050	405 x 250 x 50 mm
12.0431.070	540 x 250 x 70 mm	12.0433.070	405 x 250 x 70 mm
12.0431.100	540 x 250 x 100 mm	12.0433.100	405 x 250 x 100 mm
12.0432.050	480 x 250 x 50 mm	12.0434.050	255 x 250 x 50 mm
12.0432.070	480 x 250 x 70 mm	12.0434.070	255 x 250 x 70 mm
12.0432.100	480 x 250 x 100 mm	12.0434.100	255 x 250 x 100 mm



Taca z drutu stalowego i blachy perforowanej z pokrywą
Steel wire and perforated sheet tray with lid
Поднос из проволоки и перфорированного металлического листа с крышкой

12.0435.050	540 x 250 x 50 mm	12.0437.050	405 x 250 x 50 mm
12.0435.070	540 x 250 x 70 mm	12.0437.070	405 x 250 x 70 mm
12.0435.100	540 x 250 x 100 mm	12.0437.100	405 x 250 x 100 mm
12.0436.050	480 x 250 x 50 mm	12.0438.050	255 x 250 x 50 mm
12.0436.070	480 x 250 x 70 mm	12.0438.070	255 x 250 x 70 mm
12.0436.100	480 x 250 x 100 mm	12.0438.100	255 x 250 x 100 mm



Taca z drutu stalowego

Steel mesh tray

Поддон из нержавеющей проволоки

12.0328.030	30 x 30 x 30 mm
12.0329.020	40 x 40 x 20 mm
12.0329.040	40 x 40 x 40 mm
12.0330.020	60 x 60 x 20 mm
12.0330.040	60 x 60 x 40 mm
12.0330.060	60 x 60 x 60 mm
12.0331.020	80 x 80 x 20 mm
12.0331.140	80 x 40 x 40 mm
12.0331.040	80 x 80 x 40 mm
12.0331.060	80 x 80 x 60 mm
12.0331.080	80 x 80 x 80 mm
12.0332.010	100 x 100 x 10 mm
12.0333.030	120 x 120 x 30 mm
12.0333.060	120 x 120 x 60 mm
12.0333.080	120 x 120 x 80 mm
12.0334.030	240 x 240 x 30 mm
12.0334.060	240 x 240 x 60 mm
12.0334.080	240 x 240 x 80 mm
12.0334.100	240 x 240 x 100 mm



K2-740

Filtr papierowy, jednorazowy, opak. 100 szt.

Single use paper filter, 100 pcs

Бумажный фильтр, одноразовый, 100 шт.



Maty silikonowe

Silicone mats

Силиконовые коврики

12.0718.000	275 x 125 mm
12.0719.000	250 x 235 mm
12.0720.000	300 x 300 mm
12.0721.000	380 x 230 mm
12.0722.000	440 x 230 mm
12.0723.000	520 x 230 mm
12.0724.000	230 x 220 mm
12.0725.000	470 x 230 mm
12.0726.000	260 x 180 mm



12.0727.000 250 x 240 x 2 mm

12.0728.000 480 x 250 x 2 mm



K2-660

Plomby plastikowe, opak. 100 szt.

Plastic security seal, 100 pcs

Пластиковые пломбы, 100 шт.



12.0400.030 230 x 155 x 30 mm
12.0401.030 300 x 175 x 30 mm
12.0401.040 300 x 175 x 40 mm
12.0402.040 350 x 240 x 40 mm
12.0403.050 400 x 300 x 50 mm



12.0411.040 235 x 190 x 40 mm



12.0404.010 210 x 160 x 10 mm
12.0405.010 240 x 180 x 10 mm
12.0406.010 310 x 150 x 10 mm
12.0407.010 310 x 210 x 10 mm
12.0408.010 350 x 240 x 10 mm
12.0409.020 400 x 270 x 20 mm
12.0410.010 420 x 280 x 10 mm



12.0412.040 100 x 60 x 40 mm
12.0413.040 120 x 80 x 40 mm
12.0414.030 160 x 100 x 30 mm
12.0415.035 170 x 90 x 35 mm
12.0416.050 180 x 120 x 50 mm
12.0417.050 200 x 100 x 50 mm
12.0418.050 220 x 150 x 50 mm
12.0419.050 260 x 150 x 50 mm
12.0420.050 300 x 200 x 50 mm
12.0421.050 310 x 201 x 50 mm
12.0422.080 400 x 200 x 80 mm
12.0423.070 500 x 270 x 70 mm



12.0424.040 180 x 80 x 40 mm
12.0425.060 200 x 100 x 60 mm
12.0426.060 220 x 120 x 60 mm
12.0427.060 250 x 120 x 60 mm
12.0428.060 300 x 125 x 60 mm
12.0429.060 320 x 150 x 60 mm
12.0430.120 500 x 200 x 120 mm



30.4300	40 mm
30.4301	60 mm
30.4302	80 mm
30.4303	100 mm
30.4304	120 mm
30.4305	150 mm



30.4306	165 x 60 mm	0,75 l
30.4307	175 x 70 mm	1,00 l
30.4308	220 x 80 mm	2,00 l
30.4309	225 x 90 mm	2,50 l
30.4310	240 x 110 mm	3,00 l
30.4311	255 x 115 mm	4,00 l
30.4312	275 x 115 mm	4,50 l
30.4313	290 x 125 mm	6,00 l
30.4314	310 x 120 mm	6,00 l
30.4315	345 x 125 mm	8,50 l
30.4316	380 x 130 mm	11,00 l
30.4317	415 x 140 mm	14,00 l



30.4318	70 mm	0,25 l
30.4319	110 mm	0,50 l
30.4320	140 mm	1,00 l
30.4321	160 mm	1,50 l
30.4322	180 mm	2,00 l



30.4323	170 mm
30.4324	200 mm
30.4325	250 mm
30.4326	270 mm



30.4327	250 mm
30.4328	320 mm
30.4329	390 mm



30.4330	40 x 19 mm	0,05 l
30.4331	61 x 30 mm	0,07 l
30.4332	80 x 40 mm	0,14 l
30.4333	116 x 50 mm	0,35 l
30.4334	128 x 55 mm	0,45 l
30.4335	147 x 65 mm	0,70 l
30.4336	210 x 90 mm	2,50 l

Indeks

Symbole

12.0316.043	217	12.0326.051	218	12.0435.100	219	30.0132	28
12.0316.143	217	12.0327.030	218	12.0436.050	219	30.0133	28
12.0317.050	217	12.0327.031	218	12.0436.070	219	30.0134	28
12.0317.051	217	12.0327.050	218	12.0436.100	219	30.0135	28
12.0318.030	217	12.0327.051	218	12.0437.050	219	30.0136	28
12.0318.031	217	12.0327.070	218	12.0437.070	219	30.0137	28
12.0318.050	217	12.0327.071	218	12.0437.100	219	30.0138	28
12.0318.051	217	12.0327.100	218	12.0438.050	219	30.0139	28
12.0318.070	217	12.0327.101	218	12.0438.070	219	30.0140	28
12.0318.071	217	12.0328.030	220	12.0438.100	219	30.0141	28
12.0318.100	217	12.0329.020	220	12.0439	217	30.0142	28
12.0318.101	217	12.0329.040	220	12.0440	217	30.0143	28
12.0319.030	217	12.0330.020	220	12.0441	217	30.0144	28
12.0319.031	217	12.0330.040	220	12.0442	217	30.0145	28
12.0319.050	217	12.0330.060	220	12.0718.000	220	30.0146	28
12.0319.051	217	12.0331.020	220	12.0719.000	220	30.0147	28
12.0319.070	217	12.0331.040	220	12.0720.000	220	30.0148	28
12.0319.071	217	12.0331.060	220	12.0721.000	220	30.0149	28
12.0319.100	217	12.0331.140	220	12.0722.000	220	30.0150	28
12.0319.101	217	12.0332.010	220	12.0723.000	220	30.0151	28
12.0320.030	217	12.0333.030	220	12.0724.000	220	30.0152	28
12.0320.031	217	12.0333.060	220	12.0725.000	220	30.0153	28
12.0320.050	217	12.0333.080	220	12.0726.000	220	30.0154	28
12.0320.051	217	12.0334.030	220	12.0727.000	220	30.0155	28
12.0320.070	217	12.0334.060	220	12.0728.000	220	30.0156	28
12.0320.071	217	12.0334.080	220	30.0041	7	30.0157	28
12.0320.100	217	12.0334.100	220	30.0042	7	30.0158	28
12.0320.101	217	12.0400.030	221	30.0043	7	30.0159	28
12.0321.030	217	12.0401.030	221	30.0044	7	30.0160	28
12.0321.031	217	12.0401.040	221	30.0046	7	30.0161	28
12.0321.050	217	12.0402.040	221	30.0054	59	30.0162	28
12.0321.051	217	12.0403.050	221	30.0056	59	30.0163	28
12.0321.070	217	12.0404.010	221	30.0057	59	30.0164	28
12.0321.071	217	12.0405.010	221	30.0058	59	30.0165	28
12.0321.100	217	12.0406.010	221	30.0080	58	30.0166	28
12.0321.101	217	12.0407.010	221	30.0081	58	30.0167	28
12.0322.030	218	12.0408.010	221	30.0082	58	30.0168	28
12.0322.031	218	12.0409.020	221	30.0083	58	30.0169	28
12.0322.050	218	12.0410.010	221	30.0084	58	30.0170	28
12.0322.051	218	12.0411.040	221	30.0085	58	30.0171	28
12.0322.070	218	12.0412.040	221	30.0086	58	30.0172	28
12.0322.071	218	12.0413.040	221	30.0087	58	30.0173	28
12.0322.100	218	12.0414.030	221	30.0088	58	30.0174	28
12.0322.101	218	12.0415.035	221	30.0089	58	30.0175	28
12.0323.030	218	12.0416.050	221	30.0090	58	30.0176	28
12.0323.031	218	12.0417.050	221	30.0091	58	30.0177	28
12.0323.050	218	12.0418.050	221	30.0092	58	30.0178	28
12.0323.051	218	12.0419.050	221	30.0092.100	58	30.0179	28
12.0323.070	218	12.0420.050	221	30.0093	58	30.0180	28
12.0323.071	218	12.0421.050	221	30.0094	58	30.0181	28
12.0323.100	218	12.0422.080	221	30.0094.100	58	30.0182	28
12.0323.101	218	12.0423.070	221	30.0095	58	30.0183	28
12.0324.030	218	12.0424.040	221	30.0098	7	30.0184	28
12.0324.031	218	12.0425.060	221	30.0099	7	30.0185	28
12.0324.050	218	12.0426.060	221	30.0100	58	30.0186	28
12.0324.051	218	12.0427.060	221	30.0101	58	30.0187	28
12.0324.070	218	12.0428.060	221	30.0102	58	30.0188	28
12.0324.071	218	12.0429.060	221	30.0103	58	30.0189	28
12.0324.100	218	12.0430.120	221	30.0104	58	30.0190	28
12.0324.101	218	12.0431.050	219	30.0104.100	58	30.0191	28
12.0325.040	218	12.0431.070	219	30.0105	58	30.0192	28
12.0325.041	218	12.0431.100	219	30.0105.100	58	30.0193	28
12.0325.095	218	12.0432.050	219	30.0121	28	30.0194	28
12.0325.195	218	12.0432.070	219	30.0122	28	30.0195	28
12.0326.050	218	12.0432.100	219	30.0123	28	30.0196	28
		12.0433.050	219	30.0124	28	30.0197	28
		12.0433.070	219	30.0125	28	30.0198	28
		12.0433.100	219	30.0126	28	30.0199	28
		12.0434.050	219	30.0127	28	30.0200	28
		12.0434.070	219	30.0128	28	30.0201	28
		12.0434.100	219	30.0129	28	30.0202	28
		12.0435.050	219	30.0130	28	30.0203	28
		12.0435.070	219	30.0131	28	30.0204	28

30.0205	28	30.0274	61	30.0347	8	30.0420	8
30.0206	28	30.0275	62	30.0348	8	30.0421	8
30.0207	28	30.0276	62	30.0349	8	30.0422	8
30.0208	28	30.0277	62	30.0350	8	30.0423	8
30.0209	28	30.0278	62	30.0351	8	30.0424	8
30.0210	28	30.0279	62	30.0352	8	30.0425	8
30.0211	59	30.0280	62	30.0353	8	30.0426	8
30.0212	59	30.0281	62	30.0354	8	30.0427	8
30.0213	59	30.0282	62	30.0355	8	30.0428	8
30.0214	59	30.0283	62	30.0356	8	30.0429	8
30.0215	59	30.0284	62	30.0357	8	30.0430	8
30.0216	59	30.0285	62	30.0358	8	30.0431	8
30.0217	59	30.0286	62	30.0359	8	30.0432	8
30.0218	59	30.0287	62	30.0360	8	30.0433	8
30.0219	59	30.0288	62	30.0361	8	30.0434	8
30.0220	59	30.0289	62	30.0362	8	30.0435	8
30.0221.000	60	30.0290	62	30.0363	8	30.0436	8
30.0221.130	60	30.0291	62	30.0364	8	30.0437	8
30.0222.000	60	30.0292	62	30.0365	8	30.0438	8
30.0222.130	60	30.0293	62	30.0366	8	30.0439	8
30.0223	60	30.0294	62	30.0367	8	30.0440	8
30.0224	60	30.0295	66	30.0368	8	30.0441	8
30.0225	60	30.0296	66	30.0369	8	30.0442	8
30.0226	60	30.0297	66	30.0370	8	30.0443	8
30.0227	60	30.0298	66	30.0371	8	30.0444	8
30.0228	60	30.0299	66	30.0372	8	30.0445	8
30.0229	60	30.0300	8	30.0373	8	30.0446	8
30.0230	60	30.0301	8	30.0374	8	30.0447	8
30.0231	60	30.0302	8	30.0375	8	30.0448	8
30.0232	60	30.0303	8	30.0376	8	30.0449	8
30.0233	60	30.0304	8	30.0377	8	30.0450	8
30.0234	60	30.0305	8	30.0378	8	30.0451	8
30.0235	60	30.0306	8	30.0379	8	30.0452	9
30.0236	60	30.0307	8	30.0380	8	30.0453	9
30.0237	60	30.0308	8	30.0381	8	30.0454	9
30.0238	60	30.0309	8	30.0382	8	30.0455	9
30.0239	60	30.0310	8	30.0383	8	30.0456	9
30.0240	60	30.0311	8	30.0384	8	30.0457	9
30.0241	60	30.0312	8	30.0385	8	30.0458	9
30.0242	60	30.0313	8	30.0386	8	30.0459	9
30.0243	60	30.0314	8	30.0387	8	30.0460	9
30.0244	60	30.0315	8	30.0388	8	30.0461	9
30.0245	60	30.0316	8	30.0389	8	30.0462	9
30.0246	60	30.0317	8	30.0390	8	30.0463	9
30.0247	60	30.0318	8	30.0391	8	30.0464	9
30.0248	60	30.0319	8	30.0392	8	30.0465	9
30.0249	60	30.0320	8	30.0393	8	30.0466	9
30.0250	60	30.0321	8	30.0394	8	30.0467	9
30.0251	60	30.0322	8	30.0395	8	30.0468	9
30.0252	60	30.0323	8	30.0396	8	30.0469	9
30.0253	60	30.0324	8	30.0397	8	30.0470	9
30.0254	60	30.0325	8	30.0398	8	30.0471	9
30.0255	60	30.0326	8	30.0399	8	30.0472	9
30.0256	60	30.0327	8	30.0400	8	30.0473	9
30.0257	60	30.0328	8	30.0401	8	30.0474	9
30.0258	60	30.0329	8	30.0402	8	30.0475	9
30.0259.000	60	30.0330	8	30.0403	8	30.0476	9
30.0259.160	60	30.0331	8	30.0404	8	30.0477	9
30.0260.000	60	30.0332	8	30.0405	8	30.0478	9
30.0260.160	60	30.0333	8	30.0406	8	30.0479	9
30.0261	61	30.0334	8	30.0407	8	30.0480	9
30.0262	61	30.0335	8	30.0408	8	30.0481	9
30.0263	61	30.0336	8	30.0409	8	30.0482	9
30.0264	61	30.0337	8	30.0410	8	30.0483	9
30.0265	61	30.0338	8	30.0411	8	30.0484	9
30.0266	61	30.0339	8	30.0412	8	30.0485	9
30.0267	61	30.0340	8	30.0413	8	30.0486	9
30.0268	61	30.0341	8	30.0414	8	30.0487	9
30.0269	59	30.0342	8	30.0415	8	30.0488	9
30.0270	59	30.0343	8	30.0416	8	30.0489	9
30.0271	61	30.0344	8	30.0417	8	30.0490	9
30.0272	61	30.0345	8	30.0418	8	30.0491	9
30.0273	61	30.0346	8	30.0419	8	30.0492	9

30.0493	9	30.0566	10	30.0639	10	30.0723	11
30.0494	9	30.0567	10	30.0640	10	30.0724	11
30.0495	9	30.0568	10	30.0641	10	30.0725	11
30.0496	9	30.0569	10	30.0642	10	30.0726	11
30.0497	9	30.0570	10	30.0643	10	30.0727	11
30.0498	9	30.0571	10	30.0645	10	30.1000	102
30.0499	9	30.0572	10	30.0646	10	30.1001	102
30.0500	9	30.0573	10	30.0647	10	30.1002	102
30.0501	9	30.0574	10	30.0648	10	30.1003	102
30.0502	9	30.0575	10	30.0649	10	30.1004	102
30.0503	9	30.0576	10	30.0650	10	30.1005	102
30.0504	9	30.0577	10	30.0661	10	30.1006	102
30.0505	9	30.0578	10	30.0662	10	30.1007	102
30.0506	9	30.0579	10	30.0663	10	30.1008	102
30.0507	9	30.0580	9	30.0664	10	30.1009	102
30.0508	9	30.0581	9	30.0665	10	30.1010	102
30.0509	9	30.0582	9	30.0666	10	30.1011	102
30.0510	9	30.0583	9	30.0667	10	30.1012	102
30.0511	9	30.0584	9	30.0668	10	30.1013	102
30.0512	9	30.0585	9	30.0669	10	30.1015	125
30.0513	9	30.0586	9	30.0670	10	30.1016	103
30.0514	9	30.0587	9	30.0671	10	30.1017	103
30.0515	9	30.0588	9	30.0672	10	30.1018	103
30.0516	9	30.0589	9	30.0673	10	30.1019	103
30.0517	9	30.0590	9	30.0674	10	30.1020	103
30.0518	9	30.0591	9	30.0675	10	30.1021	103
30.0519	9	30.0592	9	30.0676	10	30.1022	103
30.0520	9	30.0593	9	30.0677	10	30.1023	103
30.0521	9	30.0594	9	30.0678	10	30.1024	103
30.0522	9	30.0595	9	30.0679	10	30.1025	103
30.0523	9	30.0596	9	30.0680	10	30.1026	103
30.0524	9	30.0597	9	30.0681	10	30.1027	104
30.0525	9	30.0598	9	30.0682	10	30.1028	104
30.0526	9	30.0599	9	30.0683	10	30.1029	104
30.0527	9	30.0600	9	30.0684	10	30.1030	104
30.0528	9	30.0601	9	30.0685	11	30.1031	104
30.0529	9	30.0602	9	30.0686	11	30.1032	104
30.0530	9	30.0603	9	30.0687	11	30.1033	104
30.0531	9	30.0604	9	30.0688	11	30.1034	104
30.0532	9	30.0605	9	30.0689	11	30.1035	104
30.0533	9	30.0606	9	30.0690	11	30.1037	103
30.0534	9	30.0607	9	30.0691	11	30.1038	103
30.0535	9	30.0608	9	30.0692	11	30.1039	103
30.0536	9	30.0609	9	30.0693	11	30.1041	103
30.0537	9	30.0610	9	30.0694	11	30.1042	104
30.0538	9	30.0611	9	30.0695	11	30.1043	104
30.0539	9	30.0612	9	30.0696	11	30.1044	104
30.0540	9	30.0613	9	30.0697	11	30.1045	104
30.0541	9	30.0614	9	30.0698	11	30.1046	104
30.0542	10	30.0615	9	30.0699	11	30.1047	104
30.0543	10	30.0616	9	30.0700	11	30.1048	105
30.0544	10	30.0617	9	30.0701	11	30.1049	105
30.0545	10	30.0618	9	30.0702	11	30.1050	105
30.0546	10	30.0619	9	30.0703	11	30.1051	105
30.0547	10	30.0620	10	30.0704	11	30.1052	105
30.0548	10	30.0621	10	30.0705	11	30.1053	105
30.0549	10	30.0622	10	30.0706	11	30.1054	105
30.0550	10	30.0623	10	30.0707	11	30.1055	105
30.0551	10	30.0624	10	30.0708	11	30.1056	105
30.0552	10	30.0625	10	30.0709	11	30.1057	105
30.0553	10	30.0626	10	30.0710	11	30.1058	105
30.0554	10	30.0627	10	30.0711	11	30.1059	105
30.0555	10	30.0628	10	30.0712	11	30.1060	105
30.0556	10	30.0629	10	30.0713	11	30.1061	105
30.0557	10	30.0630	10	30.0714	11	30.1062	105
30.0558	10	30.0631	10	30.0715	11	30.1063	105
30.0559	10	30.0632	10	30.0716	11	30.1064	105
30.0560	10	30.0633	10	30.0717	11	30.1065	105
30.0561	10	30.0634	10	30.0718	11	30.1066	105
30.0562	10	30.0635	10	30.0719	11	30.1067	105
30.0563	10	30.0636	10	30.0720	11	30.1068	105
30.0564	10	30.0637	10	30.0721	11	30.1069	105
30.0565	10	30.0638	10	30.0722	11	30.1070	105
				30.0723	11		

30.1071	105	30.1146	109	30.1219	116	30.1294	121
30.1072	106	30.1147	109	30.1220	116	30.1295	121
30.1073	106	30.1148	109	30.1221	116	30.1296	121
30.1074	106	30.1149	109	30.1222	116	30.1297	121
30.1075	106	30.1150	109	30.1223	116	30.1298	121
30.1076	106	30.1151	109	30.1224	116	30.1299	121
30.1077	106	30.1152	109	30.1226	116	30.1300	122
30.1078	106	30.1153	110	30.1227	116	30.1301	122
30.1079	106	30.1154	110	30.1228	116	30.1302	122
30.1080	106	30.1155	110	30.1229	116	30.1303	122
30.1081	106	30.1156	110	30.1230	110	30.1304	122
30.1082	106	30.1157	110	30.1231	110	30.1305	122
30.1083	106	30.1158	110	30.1232	110	30.1306	123
30.1084	106	30.1159	110	30.1233	110	30.1307	123
30.1085	106	30.1160	110	30.1234	117	30.1308	123
30.1086	106	30.1161	110	30.1235	117	30.1312	123
30.1087	106	30.1162	110	30.1236	117	30.1313	123
30.1088	106	30.1163	110	30.1237	117	30.1314	123
30.1089	106	30.1164	110	30.1238	117	30.1315	124
30.1090	106	30.1165	110	30.1239	117	30.1316	124
30.1091	107	30.1166	110	30.1240	117	30.1317	124
30.1092	107	30.1167	111	30.1243	118	30.1321	124
30.1093	107	30.1168	110	30.1244	118	30.1322	124
30.1094	107	30.1169	110	30.1245	118	30.1323	124
30.1095	107	30.1170	110	30.1246	118	30.1324	125
30.1096	107	30.1171	110	30.1247	118	30.1329	125
30.1097	107	30.1172	110	30.1248	118	30.1330	125
30.1098	107	30.1173	111	30.1249	118	30.1331	125
30.1099	107	30.1174	110	30.1250	118	30.1332	125
30.1100	107	30.1175	110	30.1251	118	30.1334	125
30.1101	107	30.1176	110	30.1252	118	30.1335	125
30.1102	107	30.1177	110	30.1253	118	30.1336	125
30.1103	107	30.1178	110	30.1254	118	30.1337	126
30.1104	107	30.1179	110	30.1255	118	30.1338	126
30.1105	107	30.1180	111	30.1256	118	30.1339	126
30.1106	107	30.1181	111	30.1257	118	30.1340	126
30.1107	107	30.1182	111	30.1258	118	30.1342	126
30.1108	107	30.1183	111	30.1259	118	30.1343	126
30.1109	107	30.1184	111	30.1260	118	30.1344	126
30.1110	107	30.1185	112	30.1261	118	30.1345	126
30.1111	107	30.1186	112	30.1262	119	30.1346	126
30.1112	107	30.1187	112	30.1263	119	30.1348	126
30.1113	107	30.1188	112	30.1264	119	30.1350	127
30.1114	107	30.1189	112	30.1265	119	30.1352	127
30.1115	107	30.1190	112	30.1266	119	30.1354	127
30.1116	108	30.1191	112	30.1267	119	30.1355	127
30.1117	108	30.1192	112	30.1268	119	30.1356	127
30.1119	108	30.1193	112	30.1269	119	30.1357	127
30.1121	108	30.1195	112	30.1270	119	30.1358	128
30.1123	108	30.1196	112	30.1271	119	30.1359	128
30.1124	108	30.1197	112	30.1272	119	30.1360	128
30.1125	108	30.1198	113	30.1273	119	30.1361	128
30.1126	108	30.1199	113	30.1274	119	30.1362	128
30.1127	108	30.1200	113	30.1275	119	30.1363	128
30.1128	108	30.1201	113	30.1276	119	30.1364	129
30.1129	108	30.1202	113	30.1277	119	30.1365	129
30.1130	108	30.1203	113	30.1278	119	30.1366	129
30.1131	108	30.1204	113	30.1279	119	30.1367	129
30.1132	108	30.1205	113	30.1280	119	30.1368	129
30.1133	109	30.1206	113	30.1281	119	30.1369	129
30.1134	109	30.1207	113	30.1282	119	30.1370	129
30.1135	109	30.1208	114	30.1283	119	30.1371	130
30.1136	109	30.1209	114	30.1284	120	30.1372	130
30.1137	109	30.1210	114	30.1285	120	30.1373	130
30.1138	109	30.1211	114	30.1286	120	30.1374	130
30.1139	109	30.1212	115	30.1287	120	30.1375	130
30.1140	109	30.1213	115	30.1288	120	30.1376	130
30.1141	109	30.1214	115	30.1289	120	30.1377	131
30.1142	109	30.1215	115	30.1290	120	30.1378	131
30.1143	109	30.1216	115	30.1291	120	30.1379	131
30.1144	109	30.1217	116	30.1292	121	30.1380	131
30.1145	109	30.1218	116	30.1293	121	30.1381	131

30.1382	131	30.1463	141	30.1530	151	30.1653.002	103
30.1383	132	30.1464	141	30.1531	151	30.1653.005	103
30.1384	132	30.1465	141	30.1532	151	30.1653.007	103
30.1385	132	30.1466	141	30.1533	138	30.1653.010	103
30.1386	132	30.1467	141	30.1534	138	30.1900	63
30.1387	132	30.1468	141	30.1535	138	30.1901	63
30.1388	132	30.1469	142	30.1536	138	30.1902	63
30.1389	132	30.1470	142	30.1537	138	30.1903	63
30.1390	133	30.1471	142	30.1538	138	30.1904	63
30.1391	133	30.1472	142	30.1539	138	30.1905	63
30.1392	133	30.1473	142	30.1540	138	30.1906	63
30.1393	133	30.1474	142	30.1541	138	30.1907	63
30.1394	133	30.1475	142	30.1542	138	30.1908	63
30.1395	133	30.1476	142	30.1543	138	30.1909	63
30.1396	133	30.1477	142	30.1544	138	30.1910	63
30.1397	133	30.1478	142	30.1545	138	30.1911	63
30.1402	134	30.1479	142	30.1546	139	30.1912	64
30.1403	134	30.1480	142	30.1547	139	30.1913	64
30.1404	134	30.1481	142	30.1548	142	30.1914	64
30.1405	135	30.1482.000	143	30.1550	152	30.1915	64
30.1409	135	30.1482.100	143	30.1551	152	30.1916	64
30.1410	135	30.1483	143	30.1552	152	30.1917	64
30.1411	135	30.1484	143	30.1553	152	30.1918	64
30.1412	136	30.1485	143	30.1554	153	30.1919	64
30.1413	136	30.1486	143	30.1555	153	30.1920	64
30.1414	136	30.1487	144	30.1556	154	30.1921	64
30.1415	136	30.1488	144	30.1557	154	30.1922	64
30.1416	136	30.1489	144	30.1558	154	30.1923	64
30.1417	137	30.1490	144	30.1559	155	30.1924	65
30.1418	137	30.1491	144	30.1560	155	30.1925	65
30.1419	137	30.1491.025	144	30.1561	155	30.1926	65
30.1420	100	30.1492	144	30.1562	155	30.1927	65
30.1421	100	30.1492.025	144	30.1563	155	30.1928	65
30.1422	100	30.1493	145	30.1564	156	30.1929	65
30.1423	100	30.1493.035	145	30.1565	156	30.1930	65
30.1424	100	30.1494	145	30.1566	156	30.1931	65
30.1425	100	30.1494.035	145	30.1567	156	30.1932	65
30.1426	100	30.1495	145	30.1568	156	30.1935	76
30.1427	100	30.1495.100	145	30.1569	156	30.1936	76
30.1428	100	30.1495.200	145	30.1570	156	30.1937	95
30.1429	100	30.1496	145	30.1571	157	30.1938	95
30.1430	100	30.1497.000	145	30.1572	157	30.1939	95
30.1431	101	30.1497.100	145	30.1573	157	30.1940	95
30.1432	101	30.1498	146	30.1574	157	30.1941	95
30.1433	101	30.1499	146	30.1575	157	30.1942	95
30.1434	101	30.1500	146	30.1576	157	30.1943	98
30.1435	101	30.1501	146	30.1577	157	30.1944	98
30.1436	101	30.1502	146	30.1578	157	30.1945	98
30.1437	101	30.1503	147	30.1579	157	30.1946	98
30.1438	139	30.1504	147	30.1580	157	30.1947	80
30.1439	139	30.1507	147	30.1581	157	30.1948	80
30.1440	139	30.1508	148	30.1582	157	30.1949	80
30.1441	139	30.1509	148	30.1583	157	30.1950	80
30.1442	140	30.1510	148	30.1584	157	30.1951	80
30.1443	140	30.1511	148	30.1585	157	30.1952	80
30.1444	140	30.1512	148	30.1586	158	30.1953	98
30.1445	140	30.1513	148	30.1587	158	30.1954	98
30.1446	140	30.1514	148	30.1588	158	30.1955	98
30.1447	140	30.1515	148	30.1589	158	30.1956	67
30.1450	140	30.1516	148	30.1590	139	30.2000	66
30.1451	140	30.1517	149	30.1591	139	30.2001	66
30.1452	140	30.1518	149	30.1592	139	30.2002	66
30.1453	140	30.1519	150	30.1593	139	30.2003	66
30.1454	140	30.1520	150	30.1600.000	159	30.2004	66
30.1455	140	30.1521	150	30.1600.001	159	30.2005	66
30.1456	140	30.1522	150	30.1600.002	159	30.2006	66
30.1457	140	30.1523	150	30.1600.100	159	30.2007	66
30.1458	141	30.1525	150	30.1600.200	159	30.2008	66
30.1459	141	30.1526	151	30.1600.300	159	30.2009	66
30.1460	141	30.1527	151	30.1600.400	159	30.2010	66
30.1461	141	30.1528	151	30.1600.500	159	30.2011	66
30.1462	141	30.1529	151	30.1653.001	103	30.2012	66

30.2013	66	30.2088	73	30.2158	78	30.2231	88
30.2014	67	30.2089	73	30.2159	78	30.2232	88
30.2015	67	30.2089.250	73	30.2160	78	30.2233	88
30.2016	67	30.2090	73	30.2161	78	30.2234	88
30.2017	67	30.2090.250	73	30.2162	78	30.2235	88
30.2018	67	30.2091	74	30.2163	78	30.2236	88
30.2019	67	30.2092	74	30.2164	78	30.2237	88
30.2020	67	30.2093	74	30.2165	78	30.2238	88
30.2021	67	30.2094	74	30.2167	79	30.2239	88
30.2022	67	30.2095	74	30.2168	79	30.2240	88
30.2023	68	30.2095.270	74	30.2169	79	30.2241	88
30.2024	68	30.2096	74	30.2170	79	30.2242	88
30.2025	68	30.2097	74	30.2171	79	30.2243	88
30.2026	68	30.2097.270	74	30.2172	79	30.2244	88
30.2027	68	30.2098	74	30.2173	79	30.2245	88
30.2028	68	30.2099	74	30.2174	79	30.2246	88
30.2029	68	30.2100	74	30.2175	79	30.2247	88
30.2030	68	30.2101	74	30.2176	79	30.2248	88
30.2031	68	30.2102	75	30.2177	79	30.2249	88
30.2032	69	30.2103	75	30.2178	79	30.2250	88
30.2033	69	30.2104	75	30.2179	79	30.2251	88
30.2034	69	30.2105	75	30.2180	79	30.2252	90
30.2035	69	30.2106	75	30.2181	79	30.2253	90
30.2036	69	30.2107	75	30.2182	79	30.2254	90
30.2037	69	30.2108	75	30.2183	79	30.2255	90
30.2039	69	30.2109	75	30.2184	80	30.2256	90
30.2041	69	30.2114	75	30.2185	80	30.2257	90
30.2042	69	30.2115	75	30.2186	80	30.2258	90
30.2043	70	30.2116	75	30.2187	80	30.2259	90
30.2044	70	30.2117	75	30.2188	80	30.2260	90
30.2045	70	30.2118	75	30.2189	80	30.2261	91
30.2046	70	30.2119	75	30.2190	81	30.2262	91
30.2047	70	30.2120	75	30.2191	81	30.2263	91
30.2048	70	30.2121.000	76	30.2192	81	30.2264	91
30.2049	70	30.2121.180	76	30.2193	81	30.2265	91
30.2050	70	30.2122.000	76	30.2194	81	30.2266	92
30.2051	70	30.2122.180	76	30.2195	81	30.2267	92
30.2052	70	30.2123	76	30.2196	81	30.2268	92
30.2053	70	30.2124	76	30.2197	81	30.2269	92
30.2054	70	30.2125	76	30.2198	81	30.2270	92
30.2055	70	30.2127	76	30.2199	81	30.2271	92
30.2056.100	70	30.2128	76	30.2200	82	30.2272	92
30.2057	71	30.2129	76	30.2201	82	30.2273	92
30.2058	71	30.2130	62	30.2202	82	30.2274	92
30.2059	71	30.2130.000	76	30.2203	82	30.2275	92
30.2059.145	71	30.2130.150	76	30.2204	82	30.2276	92
30.2060	71	30.2131	77	30.2205	82	30.2277	92
30.2061	71	30.2132	77	30.2206	82	30.2278	92
30.2062	71	30.2133	77	30.2207	82	30.2279	92
30.2063	71	30.2134	77	30.2208	83	30.2280	92
30.2064	71	30.2135	77	30.2209	83	30.2281	92
30.2065	71	30.2136	77	30.2210	83	30.2282	93
30.2066	71	30.2137	77	30.2211	83	30.2283	93
30.2068	72	30.2138	77	30.2212	83	30.2284	93
30.2069	72	30.2139	77	30.2213	83	30.2285	93
30.2070	72	30.2140	77	30.2214	83	30.2286	93
30.2071	72	30.2141	77	30.2215	83	30.2287	93
30.2072	72	30.2142	77	30.2216	83	30.2288	93
30.2073	72	30.2143	77	30.2217	84	30.2289	93
30.2074	72	30.2144	77	30.2218	84	30.2294	94
30.2075	72	30.2145	77	30.2219	84	30.2295	94
30.2076	72	30.2146	78	30.2220	84	30.2296	94
30.2077	72	30.2147	78	30.2221	84	30.2297	94
30.2078	72	30.2148	78	30.2222	84	30.2328.010	29
30.2079	72	30.2149	78	30.2223	84	30.2328.011	29
30.2080	72	30.2150	78	30.2224	84	30.2328.012	29
30.2082	73	30.2151	78	30.2225	85	30.2328.090	29
30.2083	73	30.2152	78	30.2226	85	30.2329.010	29
30.2084	73	30.2153	78	30.2227	85	30.2329.011	29
30.2085	73	30.2154	78	30.2228	85	30.2329.012	29
30.2086	73	30.2155	78	30.2229	85	30.2329.090	29
30.2087	73	30.2156	78	30.2230	88	30.2331	29

30.2332	29	30.2405	32	30.2481	41	30.2552	45
30.2333	29	30.2406	32	30.2482	41	30.2553	45
30.2335	29	30.2407	32	30.2483	41	30.2554	45
30.2336	29	30.2408	32	30.2484	41	30.2555	45
30.2337	29	30.2409	32	30.2485	41	30.2556	45
30.2338	29	30.2410	32	30.2486	41	30.2557	44
30.2339	29	30.2411	33	30.2487	41	30.2558	44
30.2340	29	30.2412	33	30.2488	41	30.2559	44
30.2341	29	30.2413	33	30.2489	41	30.2560	44
30.2342	29	30.2414	33	30.2490	41	30.2561	44
30.2343	29	30.2415	33	30.2491	41	30.2562	44
30.2344	29	30.2416	33	30.2492	41	30.2563	44
30.2345	29	30.2417	33	30.2493	41	30.2564	44
30.2346	29	30.2418	33	30.2494	41	30.2565	44
30.2347	29	30.2419	34	30.2495	42	30.2566	44
30.2348	29	30.2420	34	30.2496	42	30.2567	45
30.2349	29	30.2421	34	30.2497	42	30.2568	45
30.2350	29	30.2422	34	30.2498	42	30.2570	36
30.2351	29	30.2423	34	30.2499	42	30.2571	36
30.2352	29	30.2424	34	30.2500	42	30.2572	36
30.2353	29	30.2425	34	30.2501	42	30.2573	36
30.2354	29	30.2427	35	30.2502	42	30.2574	36
30.2355	29	30.2428	35	30.2503	42	30.2575	36
30.2356	30	30.2429	35	30.2505	42	30.2576	36
30.2357	30	30.2430	35	30.2506	42	30.2577	30
30.2358	30	30.2431	35	30.2507	42	30.2578	30
30.2359	30	30.2432	35	30.2508	42	30.2579	30
30.2360	30	30.2433	35	30.2509	42	30.2580	43
30.2361	30	30.2434	35	30.2510	43	30.2581	43
30.2362	30	30.2435	35	30.2511	43	30.2582	43
30.2363	30	30.2436	36	30.2512	86	30.2583	43
30.2364	30	30.2437	36	30.2513	86	30.2584	43
30.2365	30	30.2438	36	30.2514	86	30.2585	43
30.2366	30	30.2439	36	30.2515	86	30.2586	43
30.2367	30	30.2440	39	30.2516	86	30.2587	43
30.2368	30	30.2441	37	30.2517	86	30.2588	43
30.2369	30	30.2443	37	30.2518	86	30.2589	43
30.2370	30	30.2444	37	30.2519	86	30.2680	21
30.2371	31	30.2446	37	30.2520	87	30.2681	21
30.2372	31	30.2447	37	30.2521	87	30.2683	23
30.2373.000	31	30.2448	37	30.2522	87	30.2684	23
30.2373.100	31	30.2449	37	30.2523	87	30.2685.140	27
30.2374.000	31	30.2450	38	30.2524	87	30.2685.180	27
30.2374.100	31	30.2451	38	30.2525	87	30.2685.220	27
30.2375	31	30.2452	38	30.2526	87	30.2686.140	27
30.2376	31	30.2453	38	30.2527	87	30.2686.180	27
30.2378	31	30.2454	38	30.2528	87	30.2686.220	27
30.2380	31	30.2455	38	30.2529	87	30.2687.140	27
30.2381	31	30.2456	38	30.2530	87	30.2688.140	27
30.2382	31	30.2457	38	30.2531	34	30.2689.140	27
30.2383	28	30.2458	38	30.2532	44	30.2689.180	27
30.2384	28	30.2459	38	30.2533	44	30.2690	24
30.2385	28	30.2460	38	30.2533.230	44	30.2691	24
30.2386	28	30.2461	39	30.2534	44	30.2692	24
30.2387	28	30.2462	39	30.2535	44	30.2693	24
30.2388	28	30.2464	39	30.2535.230	44	30.2694	26
30.2389	32	30.2465	39	30.2536	44	30.2695	26
30.2390	32	30.2466	37	30.2537	44	30.2696	26
30.2391	32	30.2467	37	30.2538	44	30.2699	92
30.2392	32	30.2468	37	30.2539	44	30.2700	19
30.2393	32	30.2469	37	30.2540	44	30.2701	19
30.2394	32	30.2470	37	30.2541	44	30.2702	19
30.2395	32	30.2471	37	30.2542	44	30.2703	19
30.2396	32	30.2472	41	30.2543	44	30.2704	19
30.2397	33	30.2473	41	30.2544	44	30.2705	19
30.2398	33	30.2474	41	30.2545	44	30.2706	19
30.2399	33	30.2475	41	30.2546	45	30.2707	19
30.2400	33	30.2476	41	30.2547	45	30.2708	19
30.2401	32	30.2477	41	30.2548	45	30.2709	19
30.2402	32	30.2478	41	30.2549	45	30.2710	19
30.2403	32	30.2479	41	30.2550	45	30.2711	19
30.2404	32	30.2480	41	30.2551	45	30.2712	19

30.2713	19	30.2786	25	30.3126	97	30.3369	47
30.2715	19	30.2787	25	30.3299.001	46	30.3370	47
30.2716	19	30.2788	25	30.3299.002	46	30.3371	47
30.2717	19	30.2789	25	30.3299.003	46	30.3372	47
30.2718	19	30.2790	25	30.3300	46	30.3373	47
30.2719	19	30.2791	25	30.3301	46	30.3374	47
30.2720	20	30.2792	25	30.3302	46	30.3375	47
30.2721	20	30.2793	25	30.3303	46	30.3376	47
30.2722	20	30.2794	25	30.3304	46	30.3377	47
30.2723	20	30.2795	26	30.3305	46	30.3378	47
30.2724	20	30.2796	26	30.3306	46	30.3379	47
30.2725	20	30.2797	26	30.3307	46	30.3380	48
30.2726	21	30.2798	26	30.3308	46	30.3381	48
30.2727	21	30.2799	26	30.3309	46	30.3382	48
30.2728	21	30.2800	26	30.3310	46	30.3383	48
30.2729	21	30.2801	26	30.3311	46	30.3384	48
30.2730	20	30.2802	26	30.3312	46	30.3385	48
30.2731	20	30.2803	26	30.3313	46	30.3386	48
30.2732	21	30.2804	26	30.3314	46	30.3387	48
30.2733	21	30.2805	26	30.3315	46	30.3388	48
30.2734	22	30.2806	26	30.3316	46	30.3389	48
30.2735	22	30.2807	26	30.3317	46	30.3390	48
30.2736	22	30.2808	26	30.3318	46	30.3391	48
30.2737	22	30.2809	26	30.3319	46	30.3392	48
30.2738	22	30.2810	26	30.3320	46	30.3393	48
30.2739	22	30.2811	26	30.3321	46	30.3394	48
30.2740	22	30.2812	26	30.3322	46	30.3395	48
30.2741	22	30.2814	27	30.3323	46	30.3396	48
30.2742	22	30.2815.000	27	30.3324	46	30.3397	48
30.2743	22	30.2815.140	27	30.3325	46	30.3398	48
30.2744	22	30.2816	27	30.3326	46	30.3399	48
30.2745	22	30.2817	27	30.3327	46	30.3400	48
30.2746	23	30.2818	27	30.3328	46	30.3401	48
30.2747	23	30.2819	27	30.3329	46	30.3402	48
30.2748	23	30.2820	27	30.3330	46	30.3403	48
30.2749	23	30.2821	27	30.3331	46	30.3404	48
30.2750	23	30.2822	27	30.3332	46	30.3405	48
30.2751	23	30.2823	27	30.3333	46	30.3406	48
30.2752	23	30.2824	11	30.3334	46	30.3407	48
30.2753	23	30.2824.150	11	30.3335	46	30.3408	48
30.2754	23	30.2824.210	11	30.3336	46	30.3409	48
30.2755	23	30.2825	11	30.3337	46	30.3410	48
30.2756	23	30.2827	39	30.3338	46	30.3411	48
30.2757	23	30.2828	39	30.3339	46	30.3412	48
30.2758	23	30.2829	39	30.3340	46	30.3413	48
30.2759	24	30.2830	39	30.3341	46	30.3414	48
30.2760	24	30.2831	39	30.3342	46	30.3415	48
30.2761	24	30.2832	39	30.3343	46	30.3416	48
30.2762	24	30.2923	96	30.3344	46	30.3417	48
30.2763	24	30.2924	96	30.3345	46	30.3418	48
30.2764	24	30.2925	96	30.3346	46	30.3419	48
30.2765	24	30.2926	96	30.3347	46	30.3420	48
30.2766	24	30.2927	96	30.3348	46	30.3421	48
30.2767	24	30.2928	96	30.3349	46	30.3422	48
30.2768	24	30.2929	96	30.3350	46	30.3429	48
30.2769	24	30.2930	96	30.3351	46	30.3430	48
30.2770	24	30.2931	96	30.3352	46	30.3431	48
30.2771	24	30.2932	96	30.3353	46	30.3432	48
30.2772	24	30.2933	96	30.3357	46	30.3434	48
30.2773	24	30.2934	96	30.3358	46	30.3441	49
30.2774	24	30.2935	96	30.3359.000	46	30.3442	49
30.2775	24	30.2936	96	30.3359.150	46	30.3449.000	49
30.2776	25	30.2937	96	30.3360.000	46	30.3449.007	49
30.2777	25	30.2938	96	30.3360.150	46	30.3450	49
30.2778	25	30.3112	96	30.3361	46	30.3452	49
30.2779	25	30.3113	96	30.3362	46	30.3453	49
30.2780	25	30.3114	96	30.3363	46	30.3454	49
30.2781	25	30.3118	97	30.3364	46	30.3455	49
30.2782	25	30.3119	97	30.3365	47	30.3456	49
30.2783	25	30.3120	97	30.3366	47	30.3457	49
30.2784	25	30.3124	97	30.3367	47	30.3458	50
30.2785	25	30.3125	97	30.3368	47	30.3459	50

30.3460	50	30.3533	52	30.3605	57	30.4198	18
30.3461	50	30.3534	54	30.3606	57	30.4215	17
30.3462	50	30.3535	54	30.3607	57	30.4216	17
30.3463	50	30.3536	54	30.3608	57	30.4217	17
30.3464	50	30.3537	54	30.3609	57	30.4218	17
30.3465	50	30.3538	54	30.3610	57	30.4219	17
30.3466	50	30.3539	54	30.3611	57	30.4230	99
30.3467	50	30.3540	54	30.3612	57	30.4231	99
30.3468	50	30.3541	54	30.3613	57	30.4233	99
30.3469	50	30.3542	54	30.3614	57	30.4234	99
30.3470	50	30.3543	54	30.3615	57	30.4235	99
30.3471	50	30.3544	54	30.3616	57	30.4236	99
30.3472	50	30.3545	54	30.3617	57	30.4300	222
30.3473	50	30.3546	54	30.3618	57	30.4301	222
30.3474.000	50	30.3547	54	30.3619	57	30.4302	222
30.3474.180	50	30.3548	54	30.3620	57	30.4303	222
30.3475	50	30.3549	54	30.3621	57	30.4304	222
30.3476	50	30.3550	54	30.4127	12	30.4305	222
30.3480	51	30.3551	54	30.4128	12	30.4306	222
30.3481	51	30.3552	54	30.4129	12	30.4307	222
30.3482	51	30.3553	54	30.4131	12	30.4308	222
30.3483	51	30.3554	54	30.4132	12	30.4309	222
30.3484	51	30.3555	54	30.4133	12	30.4310	222
30.3485	51	30.3556	54	30.4134	12	30.4311	222
30.3486	51	30.3557	54	30.4135	12	30.4312	222
30.3487	51	30.3558	54	30.4136	12	30.4313	222
30.3488	51	30.3559	54	30.4137	12	30.4314	222
30.3489	51	30.3560	54	30.4138	12	30.4315	222
30.3490	51	30.3561	54	30.4139	12	30.4316	222
30.3491	51	30.3562	54	30.4140	13	30.4317	222
30.3492	51	30.3563	54	30.4141	13	30.4318	222
30.3493	51	30.3564	54	30.4142	13	30.4319	222
30.3494	51	30.3565	54	30.4143	13	30.4320	222
30.3495	51	30.3566	54	30.4144	13	30.4321	222
30.3496	51	30.3567	54	30.4145	13	30.4322	222
30.3497	51	30.3568	54	30.4146	13	30.4323	222
30.3498	51	30.3569	54	30.4147	13	30.4324	222
30.3499	51	30.3570	54	30.4148	14	30.4325	222
30.3500	51	30.3571	54	30.4149	14	30.4326	222
30.3501	51	30.3572	54	30.4150	14	30.4327	222
30.3502	51	30.3573	54	30.4151	14	30.4328	222
30.3504	52	30.3574	54	30.4152	14	30.4329	222
30.3505	52	30.3575	54	30.4153	14	30.4330	222
30.3510.000	89	30.3576	54	30.4154	15	30.4331	222
30.3510.115	89	30.3577	54	30.4155	15	30.4332	222
30.3510.130	89	30.3578	54	30.4156	15	30.4333	222
30.3510.145	89	30.3579	54	30.4157	15	30.4334	222
30.3510.160	89	30.3580	54	30.4158	15	30.4335	222
30.3510.180	89	30.3581	55	30.4159	15	30.4336	222
30.3510.200	89	30.3582	55	30.4160	16	30.4350	7
30.3511.115	89	30.3583	52	30.4161	16	40.3284	40
30.3511.130	89	30.3584	52	30.4162	16	40.3285	40
30.3511.145	89	30.3585	52	30.4163	16	40.3286	40
30.3511.160	89	30.3586	52	30.4164	16	40.3287	40
30.3511.180	89	30.3587	52	30.4165	16	40.4139	40
30.3514	53	30.3588	52	30.4166	17	40.4140	40
30.3517	53	30.3589	55	30.4167	17	40.4141	40
30.3518	53	30.3590	55	30.4168	17	40.4142	40
30.3519	53	30.3591	55	30.4184	17	40.4143	40
30.3520	53	30.3592	55	30.4185	17	40.4144	40
30.3521	53	30.3593	55	30.4186	17	40.4145	40
30.3522	53	30.3594	55	30.4187	18	40.6792	146
30.3523	53	30.3595	55	30.4188	18	40.7216	111
30.3524	52	30.3596	55	30.4189	18	80.0200	163
30.3525	52	30.3597	55	30.4190	18	80.0201	163
30.3526	52	30.3598	56	30.4191	18	80.0202	163
30.3527	52	30.3599	56	30.4192	18	80.0203	163
30.3528	52	30.3600	56	30.4193	18	80.0204	163
30.3529	52	30.3601	56	30.4194	18	80.0205	163
30.3530	52	30.3602	56	30.4195	18	80.0206	163
30.3531	52	30.3603	56	30.4196	18	80.0207	163
30.3532	52	30.3604	56	30.4197	18	80.0208	164

80.0209	164	80.0284	169	80.0383	176	90.0070	189
80.0210	164	80.0285	169	80.0384	176	90.0071	189
80.0211	164	80.0286	169	80.0385	176	90.0100	190
80.0212	165	80.0287	169	80.0390	176	90.0101	190
80.0213	165	80.0288	169	80.0391	176	90.0102	190
80.0214	165	80.0289	169	80.0392	176	90.0103	190
80.0215	165	80.0293	169	80.0393	176	90.0104	190
80.0216	165	80.0294	169	80.0402	176	90.0105	190
80.0217	165	80.0303	170	80.0403	176	90.0106	190
80.0218	165	80.0304	170	80.0404	176	90.0107	190
80.0219	165	80.0305	170	80.0405	176	90.0108	190
80.0220	166	80.0306	170	80.0422	176	90.0109	190
80.0221	166	80.0307	170	80.0423	176	90.0110	190
80.0222	166	80.0308	170	80.0424	176	90.0111	190
80.0223	166	80.0309	170	80.0425	176	90.0112	190
80.0224	166	80.0310	170	80.0427	177	90.0113	190
80.0225	166	80.0311	170	80.0428	177	90.0114	190
80.0227	166	80.0312	170	80.0429	177	90.0117.000	190
80.0228	166	80.0313	171	80.0430	177	90.0117.001	190
80.0229	166	80.0314	171	80.0431	177	90.0117.002	190
80.0230	166	80.0315	171	80.0432	177	90.0118.000	190
80.0231	166	80.0316	171	80.0433	177	90.0118.001	190
80.0232	166	80.0317	171	80.0434	177	90.0118.002	190
80.0233	166	80.0318	171	80.0435	177	90.0119.000	190
80.0234	166	80.0319	171	80.0436	177	90.0119.001	190
80.0237	166	80.0320	171	90.0001	181	90.0119.002	190
80.0238	166	80.0321	171	90.0005	181	90.0122	190
80.0239	166	80.0322	171	90.0006	181	90.0123	190
80.0240	166	80.0323	172	90.0007	181	90.0124	190
80.0241	167	80.0324	172	90.0008	182	90.0125	190
80.0242	167	80.0325	172	90.0010	182	90.0126	190
80.0243	167	80.0326	172	90.0012	182	90.0127	190
80.0244	167	80.0327	172	90.0013	182	90.0128	190
80.0245	167	80.0328	172	90.0014	183	90.0129	191
80.0246	167	80.0329	173	90.0015	183	90.0130	191
80.0247	167	80.0330	173	90.0016	183	90.0131	191
80.0248	167	80.0331	173	90.0017	184	90.0132	191
80.0249	167	80.0332	173	90.0018	184	90.0133	191
80.0250	167	80.0333	173	90.0019	184	90.0134	191
80.0251	167	80.0334	173	90.0020	184	90.0135	191
80.0252	167	80.0335	174	90.0021	184	90.0136	191
80.0253	167	80.0336	174	90.0022	185	90.0137	191
80.0254	167	80.0337	174	90.0023	185	90.0138	191
80.0255	167	80.0338	174	90.0024	185	90.0139	191
80.0256	167	80.0339	174	90.0025	185	90.0140	191
80.0257	167	80.0340	174	90.0026	186	90.0141	191
80.0258	168	80.0341	175	90.0027	186	90.0142	191
80.0259	168	80.0342	175	90.0028	186	90.0143	191
80.0260	168	80.0343	175	90.0030	187	90.0144	191
80.0261	168	80.0344	175	90.0031	187	90.0145	191
80.0262	168	80.0345	175	90.0032	187	90.0146	191
80.0263	168	80.0346	175	90.0033	187	90.0147	192
80.0264	168	80.0350	175	90.0050	188	90.0148	192
80.0265	168	80.0351	175	90.0051	188	90.0149	192
80.0266	168	80.0352	175	90.0052	188	90.0150	192
80.0267	168	80.0362	176	90.0053	188	90.0151	192
80.0268	168	80.0363	176	90.0054	188	90.0152	192
80.0269	168	80.0364	176	90.0055	188	90.0153	192
80.0270	168	80.0365	176	90.0056	188	90.0154	192
80.0271	168	80.0366	176	90.0057	188	90.0155	192
80.0272	168	80.0367	176	90.0058	188	90.0156	192
80.0273	169	80.0368	176	90.0059	188	90.0157	192
80.0274	169	80.0369	176	90.0060	189	90.0158	192
80.0275	169	80.0370	176	90.0061	189	90.0159	192
80.0276	169	80.0371	176	90.0062	189	90.0160	192
80.0277	169	80.0372	176	90.0063	189	90.0161	193
80.0278	169	80.0373	176	90.0064	189	90.0162	193
80.0279	169	80.0374	176	90.0065	189	90.0163	193
80.0280	169	80.0375	176	90.0066	189	90.0164	193
80.0281	169	80.0376	176	90.0067	189	90.0165	193
80.0282	169	80.0377	176	90.0068	189	90.0166	193
80.0283	169	80.0382	176	90.0069	189	90.0167	193

90.0484 213
90.0485 213
90.0486 213
90.0487 213
90.0488 213
90.0489 213
90.0490 213
90.0491 213

A

A 10
Adlerkreutz 49
Adson 22, 46, 49, 57, 62, 101,
144, 145
Adson-Baby 143
Adson-Brown 49
Adson-Tönnis 35
Alexander 182
Allis 77, 78, 79
Allis-Adair 77
Allis-Baby 77
Alm 140
Anderson-Adson 145
Auvard 195

B

B 8
Babcock 78, 79
Baby-Adson 62
Baby-Collin 149
Baby-Crile 58
Baby-Lexer 31
Baby-Olsen-Hegar 21, 27
Baby-Roux 113
Baby-Satinsky 85
Baby-Senn-Miller 112
Backhaus 72
Bakes 92
Balfour 154, 155
Balfour-Baby 154
Barsky 103
Baumgartner 27
Becker-Schere 172
Beckmann 144
Beckmann-Adson 146
Beckmann-Eaton 146
Beer 55
Bellucci 163
Bengolea 63
Benson 78
Berger 182
Bergmann 106
Best 95
Bevan 95
Beyer 172
Blake 91, 204
Blount 125
Bonney 50
Bose 101
Bottcher 37
Boys-Allis 77
Bozemann 25, 75
Bozemann-Douglas 75
Br 8
Braun 202
Braun-Stadler 34
Breisky 191
Brophy 47, 49
Brown 20, 86
Bruenings 175

Bruning 171
Brunner 16, 129, 130
Brunner-Ferrozell 17
Bruns 40
Bumm 205
Busch 34

C

Caspar 121
Castroviejo 27
Cheron 74
Chevalier-Jackson 176
Chir. Pinzette 57
Citelly 171
Collier 20
Collin 74, 83, 99, 115, 149, 194,
210, 211
Collin- Hartmann 113
Collin-loktite 148
Cone 142
Cooley 136
Cooper 12
Coryllos 134
Cottle 52
Crafoord 39, 66
Crafoord-Sellers 67
Crile 22, 59, 102, 108
Crile-Rankin 59
Crile-Wood 19, 22, 26
CUSCO 193
Cushing 47, 49, 57, 102, 107, 109
Czerny 86

D

Dandy 35, 61, 100
Darmschere 39
Dartigues 211
Davidson 136
Davis 50, 76
Dean 37
Deaver 30, 131, 132
De Bakey 51
De Bakey 25, 36, 88
DeBakey 150
De la Roza 12
Denis-Browne 157
Derf 20, 27
Derom-Vandamme 159
Derra 84
Deshamps 13, 14
Desjardins 69, 90, 92, 94
Desmarres 108
Diethrich-Hogemann 36
Dietrich 36
Douglas 55
Doyen 30, 72, 79, 81, 126, 191,
192, 211, 212
Doyen-Stille 126
Dubois 34
Duckbill 166
Duplay 74, 87
Duval 79, 83

E

E 9
Elliot 209
Eppendorfer 181
Ermold 23
Esmarch 40

F

Farabeuf 115
Faure 69, 186
Feilchenfeld 54
Ferguson 11
Ferris-Smith 57, 171
Fino 32
Finochietto 22, 25
Finsen 140
Fisch 100
Foerster 75
Franz 156
Frazier 102, 153
French 24
French- Mathieu 26
Fritsch 126

G

G 8
Ga 9
Gar 9
Gee 164
Gellhorn 186
Gelpi-Loktite 150
Gemini 64
Gerald 47, 48
Gillies 21, 25, 48, 102
Gillies-Baby 25
Gil-Vernet 107
Goelet 113
Goldmann-Fox 31, 43
Gosset 152
Gr 8
Graefe 104
Graham 101
Grave 193, 196
Gray 69
Grazil 29
Green 65
Green-Armytage 213
Gross 73
Grünwald 167
Grünwald-Jansen 52
Guthrie 104

H

Haberer 138
Hagenbarth 99
Hajek 172
Hajek-Koffler 171
Halsey 19, 24
Halsted-Mosquito 58, 59
Harken 84
Harrington 132
Harrington-Baby 132
Harrington-Pemberton 132
Hartmann 58, 166, 167, 177
Hartmann-Hoffmann 166
Hartmann-Noyes 166
Heaney 22, 27, 70, 135
Heaney-Ballentine 70
Heath 39
Hegar 25, 199, 200, 201
Hegar-Baum 23
Heiss 62
Hessberg 12
Holtzheimer 140
Holzbach 147
Hösel 122

Huber 175
Hunter 54

I

Iris 45
Irisschere 42
Israel 117
Iterson 106

J

Jackson 104, 106
Jacobs 87
Jaeger 104
Jameson 23
Jansen 52, 140
Johns Hopkins 68
Jones 73
Joseph 32, 103
Judd-Allis 77
Juers 164
Jurasz 176

K

K2-660 220
K2-740 220
Kader 139
Kallmorgen 190
Kalt 11
Kantrowitz 65
Keith 9
Kelly 32, 61, 120, 125, 133, 212
Kelly-Rankin 61
Kerrison 173
Kevorkian 175, 181, 203
Kevorkian-Young 203
Kielland 210
Kielland-Luikart 210
Kilner 32, 102
Kirschner 157
Klapp 108
Kleinert-Kutz 103
Knowles 39
Kocher 17, 60, 82, 110, 111, 119,
120, 127
Kocher-Langenbeck 119
Kocher (Ochsner) 60
Kocher-Wagner 121
Koerte 139
Kogan 198
König 17, 108
Körte 116, 117
Körte-Wagner 117
Krayenbühl 100
Kristeller 190
Kronecker 12
Kuehne 55
Kuemmel 139

L

Laborde 84
La Grange 45
Lahey 68, 119
Lane 50, 72
Langenbeck 118
Langenbeck-Green 112
Lateral Retraktor 197
Laufe 98
Leriche 58

Lewkowitz 95
Ligaturschere 38
Lister 40, 42, 45, 71
Littauer 38, 55
Little 107
Lockwood-Allis 77
Lorenz 39
Lorna 72
Lovelace 61, 83
Love (Morse) 107
Lower 68
Lucae 52
Luer 108
Luer-Koerte 93
Lukens 104

M

Magill 98
Magill-Baby 98
Maier 74
Markham-Meyerding 151
Martin 128, 202, 210
Masson 22, 27
Mathieu 23, 26, 115, 192
Mayo 11, 29, 42, 44, 92, 94
Mayo-Blake 91
Mayo-Guyon 70
Mayo-Harrington 31
Mayo-Hegar 19, 24
Mayo-Lexer 31, 42, 44
Mayo-Noble 31
Mayo-Robson 79, 82
Mayo-Russian 50
Mayo-Stille 29, 42, 44
McGivney 98
Mc Indoe 37, 46
Mc Lean-Tucker 209
Meekers 65
Metzenbaum 28, 32, 41, 44
Metzenbaum Fino 45
Metzenbaum-Fino 41
Metzenbaum-Lahey 32
Metzenbaum (Strabismus) 32
Metzenbaum Strabismus 45
Meyerding 106, 137, 151
M.G.H 20
Michel 99
Middeldorf 124
Middleton- Jansen 173
Mikulicz 70, 133
Miller 102
Milligan 143
Mini-Gemini 64
Mini-Langenbeck 104
Mini-Roux 113
Mini-Tischler 187
Mittelfein 163
Mixer 30, 67, 68, 91
Mixer-Baby 67
Mixer-O'Shaugnessy 67
Modell Tübingen 128
Mod. Muenchen 204
Mod. USA 34
Mollison 143
Moore 94
Morris 123
Moynihan 71
Murphy 116
Museux 87
Myles 167

N

Nabatoff 88
Naegele 209
Narath 12
Negus 68
Nelson 50
News 101
Noto 212
Novak 203
Novak-Schoeckaert 204

O

Oa 10
Ob 10
O'Connor 104
Og 11
Ollier 116
Olsen-Hegar 21, 25
Olsen- Mathieu 26
Ombredanne 73
O'Sullivan-O'Connor 158
Overholt 65
Overholt-Geissendorfer 66

P

Pa 9
Parametrium 43
Parker 114
Parker-Langenbeck (US-Army) 114
Parker-Mott 114
Payr 11, 17, 78
Pb 10
Pc 9
Pd 10
Pean 59, 60
Pean (Rochester) 60
Pears 73
Pederson 194
Pelkmann 76
Pennington 62, 76
Peterson 196
Phaneuf 69
Piper 210
Plester 142
Potts-Smith 35, 36, 46, 50, 57
Pratt 98
Presbyterian 74
Price-Thomas 83
Prince 37
Providence Hospital 61

R

Ragnell-Davis 112
Rampley 76
Randall 90, 203
Recamier 207
Reverdin 18, 138
Reynolds 35
Ricard 147
Richardson 120, 125
Richardson-Eastman 121
Richter 30
Rigby 151
Roberts 63
Rochester 95
Rochester-Carmalt 61
Roeder 72

Rogers 80
Rogge 76
Rose 108
Rotokürette 203
Roux 113
Rumel 66
Russian 50

S

Sachs 100
Sarot 20, 27, 67
Satinsky 85
Satynsky 35
Sauerbruch 119, 135
Scalp Contour 142
Scherbak 195
Schmeden 167, 177
Schmieden 12, 16, 37
Schmieden-Dick 12
Schmieden-Payr 16
Schoenborn 101
Schröder 86
Schröder-Brown 86
Schroeder 208
Schubert 184
Schuhmacher 184, 188, 189
Schumacher 34, 181, 183
Seanger 213
Semken 46, 49
Semm 191
Senn-Green 112
Senn-Miller 112
Seutin 40
Seyffert 194
Siebold 33
Simon 127, 208
Simpson-Braun 209
Simpson-Luikart 209
Sims 33, 43, 191, 202, 206
Singley-Tut 50
Sistrunk 38
Skene 87
Smith 39
Smithwick 100
Somer 211
Spencer 38
Spencer-Wells 62
Standard 28, 41, 46, 48
Standard mod. USA 46
Staude-Moore 86
Stevens 45
Stille 65
St. Marks 123
Strabismus (Metzenbaum) 42
Strandell-Stille 109
Stratte 19, 25
Strully 35
Strümpel 166
Struycken 167, 170

T

Takahashi 170
Tayler 49
Taylor 47
Teale 86
Temple-Fay 153
Thomas 74, 206
Thoms-Allis 77
Thoms-Gaylor 186
Tischler 175, 183, 187

Tischler-Kevorkian 187
Tischler-Morgan 187
Toennis 100
Tönnis 35
Tönnis-Adson 41
Troeltsch (Wilde) 52
Trousseau 84
Tübinger Modell 143
Tuffier 126, 138

U

Ulrich 73
Uni-Burke 188, 189
Uni-Griff 189
Uni-Kevorkian 188, 189
Uni-Oval 188, 189
Uni-Tischler 188, 189
Uni-Townsend 188, 189
Universal 39, 96

V

Van Doren 185
Volkmann 106, 109, 110, 111

W

Wachenfeldt 99
Waldmann 34
Walter-Carmalt 54
Walton 96
Wangensteen 22, 57
Wassmund 117
Watson-Williams 168
Waugh 47, 49
Webster 19, 24
Weil-Blakesley 169
Weingärtner 166
Weitlaner-Baby 141
Weitlaner-Loktite 141
Weitlaner-Wullstein 141
Wertheim 33, 70, 71
Wertheim-Cullen 71
Wiener 104
Wilde 168
Williams 78
Winter 213
Wittner 182
Woodruff 12

Y

Yasargil 52
Yeoman 96
Yeoman (Turrell) 96
Young 95

Z

Zenker 63, 128
Zwiefel 204

ChM sp. z o.o.
Lewickie 3b
16-061 Juchnowiec Kościelny
Poland
tel.: +48 85 713 13 20
fax: +48 85 713 13 19
chm@chm.eu
www.chm.eu

ChM sp. z o.o.
Lewickie 3b
16-061 Juchnowiec Kościelny
Poland
tel.: +48 85 86 86 100
fax: +48 85 86 86 101
chm@chm.eu
www.chm.eu